

*Instruction
Handbook
for*

EMETTEUR TYPE DE BRUIT

01009520

**AIL TYPE 7010 AND 7011
COAXIAL NOISE
GENERATOR**

March 1965

CUTLER - HAMMER

**AIRBORNE INSTRUMENTS LABORATORY
FER PARK, LONG ISLAND, NEW YORK 11729**



**AIL /
DIVISION**

2017/10/20

TABLE OF CONTENTS

	<u>Page</u>
I. Introduction	1
II. Specifications	2
III. Operation	3
IV. Theory of Operation	4
V. Maintenance	10
VI. Parts List	11
VII. AIL Type 7011 Noise Generator	12

LIST OF ILLUSTRATIONS

<u>Figure</u>		<u>Page</u>
1	AIL Type 7010 Coaxial Noise Generator	1
2	Typical SWR (Fired and Unfired)	2
3	Parts Location	3
4	Typical Relative Excess Noise Temperature	5
5	Measured Noise Figure	6
6	Decrease in Relative Excess Noise Temperature as a Function of Noise Source Insertion Loss	7
7	Setup for Measuring Noise Figure	8
8	Type 7010 Noise Generator, Schematic Diagram	9
9	Type 7011 Coaxial Noise Generator	12
10	Lock Ring Placement	13

I. INTRODUCTION

The AIL Type 7010 Coaxial Noise Generator is an accurate source of random noise over the frequency range from 200 to 2600 Mc. It consists of an argon-filled, gas-discharge tube coaxially mounted in a helical transmission line. Type-N connectors are provided for making connections to the external RF circuit.

The AIL Type 7011 Coaxial Noise Generator is electrically identical with the AIL Type 7010 but uses Type-HN connectors at the anode and cathode. The Type 7011 is designed for permanent system installation. See Section VII.

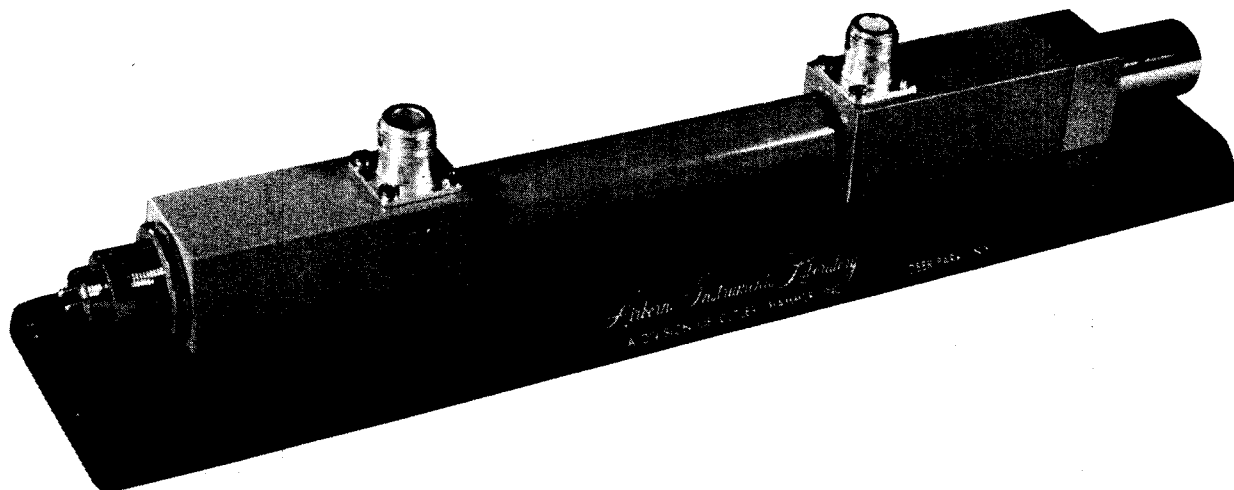

FIGURE 1. AIL TYPE 7010 COAXIAL NOISE GENERATOR

II. SPECIFICATIONS

Frequency range	200 to 2600 Mc
Tube ratings	
Relative excess noise temperature	15.6 ± 0.25 db
Operating current	175 ma
Firing voltage	~ 2 kv
SWR*	
Fired	1.35 maximum
Unfired	1.5 maximum
Size	3 x 3 x 16 inches
Weight	5 pounds

* When terminated with a 50-ohm load having an SWR of 1.10 or less (Figure 2).

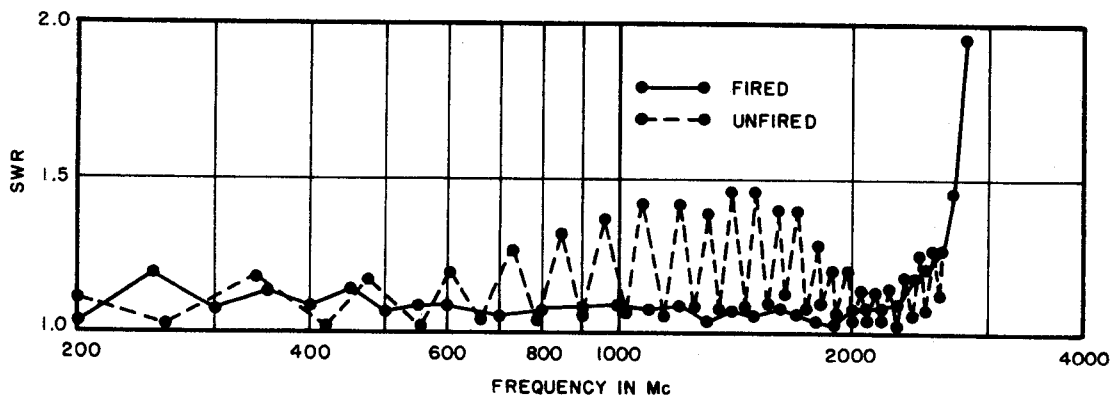

FIGURE 2. TYPICAL SWR (FIRED AND UNFIRED)

III. OPERATION

The Type 7010 can be operated with the AIL Type 7111 Power Supply to make manual noise figure measurements. When operated with the AIL Type 74A Automatic Noise Figure Indicator, both manual and automatic noise figure measurements can be made.

The Type 7010 is connected to the power source by means of the cathode connector (4, Figure 3) and anode connector (1, Figure 3). The noise-tube current must be set to approximately 175 ma for CW operation. This current value is not critical because the ratio of the change in output power to the change in current is about -0.005 db/ma.

One of the output connectors (2 and 3, Figure 3) must be terminated in a 50-ohm load with an SWR of 1.10 or less. This termination establishes the reference temperature for noise figure measurements. The remaining output connection is used to couple the noise power to the device being tested.

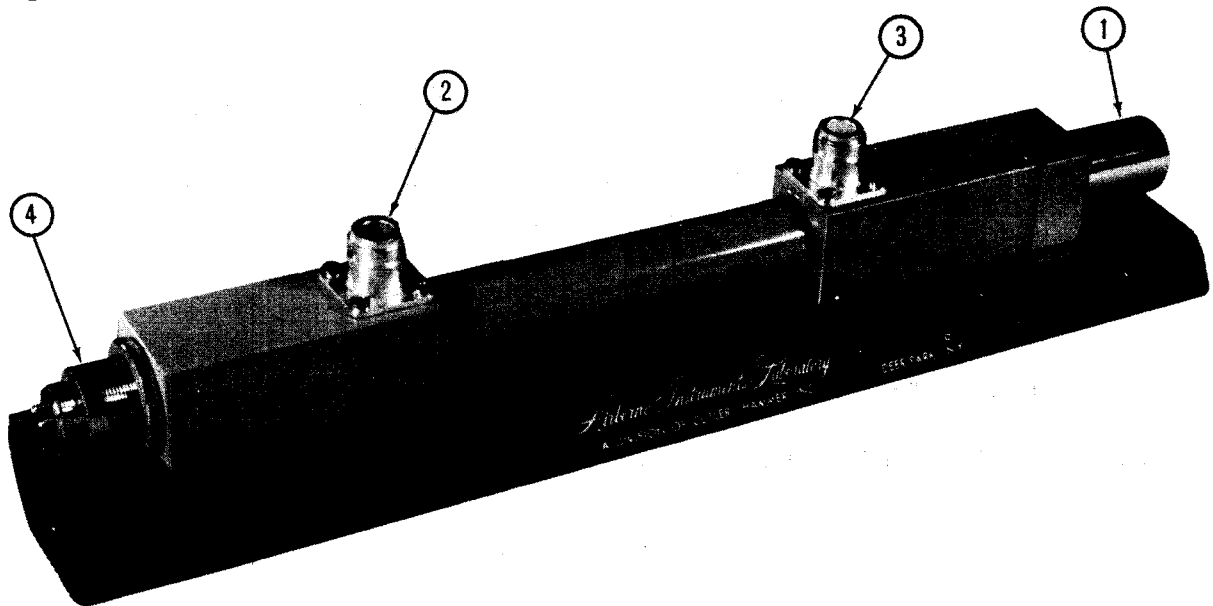

1. ANODE CONNECTOR
2. OUTPUT CONNECTOR

3. OUTPUT CONNECTOR
4. CATHODE CONNECTOR

FIGURE 3. PARTS LOCATION

IV. THEORY OF OPERATION

The Type 7010 can be used in any of the standard setups for performing noise figure measurements of receivers in the 200 to 2600 Mc range. Basically, these methods involve the measurement of the Y-factor, which is defined as the ratio of (1) the noise power from the receiver under test when terminated in a source impedance, at temperature T_2 , equivalent to the impedance from which it is intended to work, to (2) the noise power when terminated in the same value of impedance at temperature T_1 . The full expression for the noise figure of a receiver is then:

$$F = \frac{B_O}{B} \left[\frac{\left(\frac{T_2}{T_O} - 1 \right) - Y \left(\frac{T_1}{T_O} - 1 \right)}{Y - 1} \right] \quad (1)$$

where

T_2 = effective temperature of the discharge generator in its fired condition (degrees Kelvin),

T_1 = temperature of the termination when the discharge lamp is unfired (degrees Kelvin),

T_O = 290°K,

B_O = overall noise bandwidth of the receiver under test-- including image, harmonic, and other spurious responses,

B = useful-channel bandwidth of the receiver.

This expression generally can be reduced to

$$F = \frac{\left(\frac{T_2}{T_O} - 1 \right) \frac{B_O}{B}}{Y - 1} \quad (2)$$

Since T_1/T_0 is usually almost equal to unity. If B_0/B is also equal to 1, the relation between F and Y is simply:

$$F = \frac{T_{ex}}{Y - 1} \quad (3)$$

where

$$T_{ex} = \frac{T_2}{T_0} - 1 \quad (4)$$

The tube used in this generator has a rated output of 15.6 db. The value of the excess noise temperature (T_{ex}) of the generator varies from one type of gas-discharge tube to another and, due to variations in the coupling efficiency of the mount, it also varies across the operating frequency range. The actual value of T_{ex} , including corrections for these variations, may be obtained from Figure 4. Using this value of T_{ex} and the measured value of Y, the measured noise figure may be obtained by reference to Figure 5.

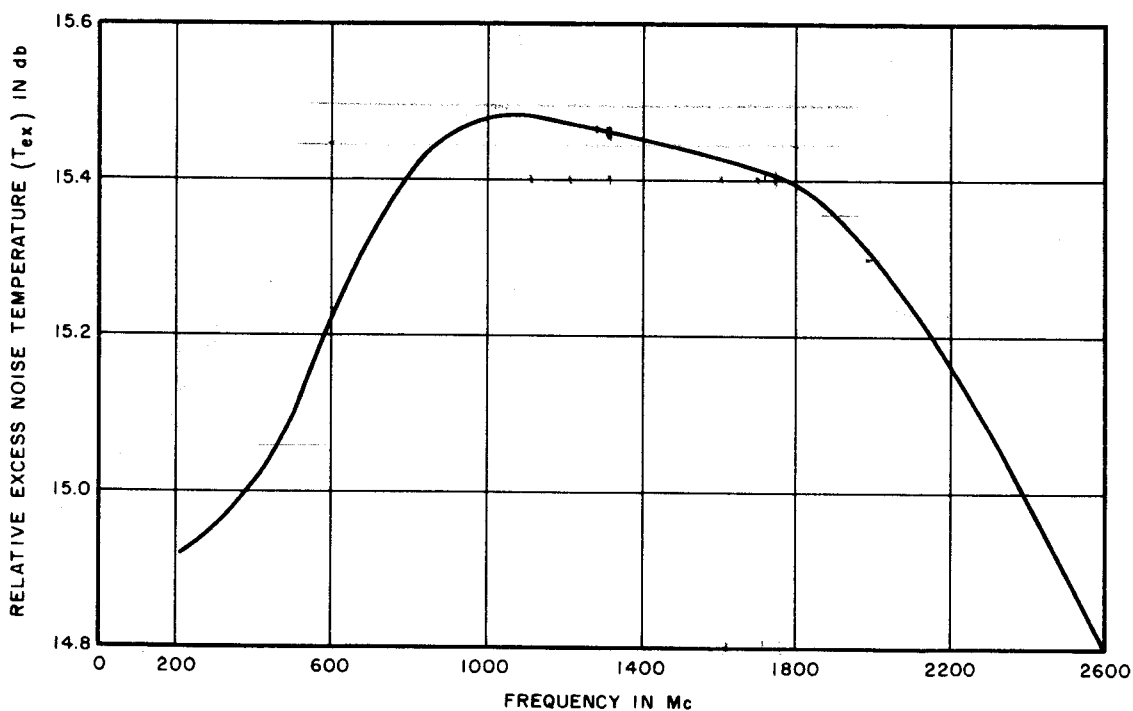

FIGURE 4. TYPICAL RELATIVE EXCESS NOISE TEMPERATURE

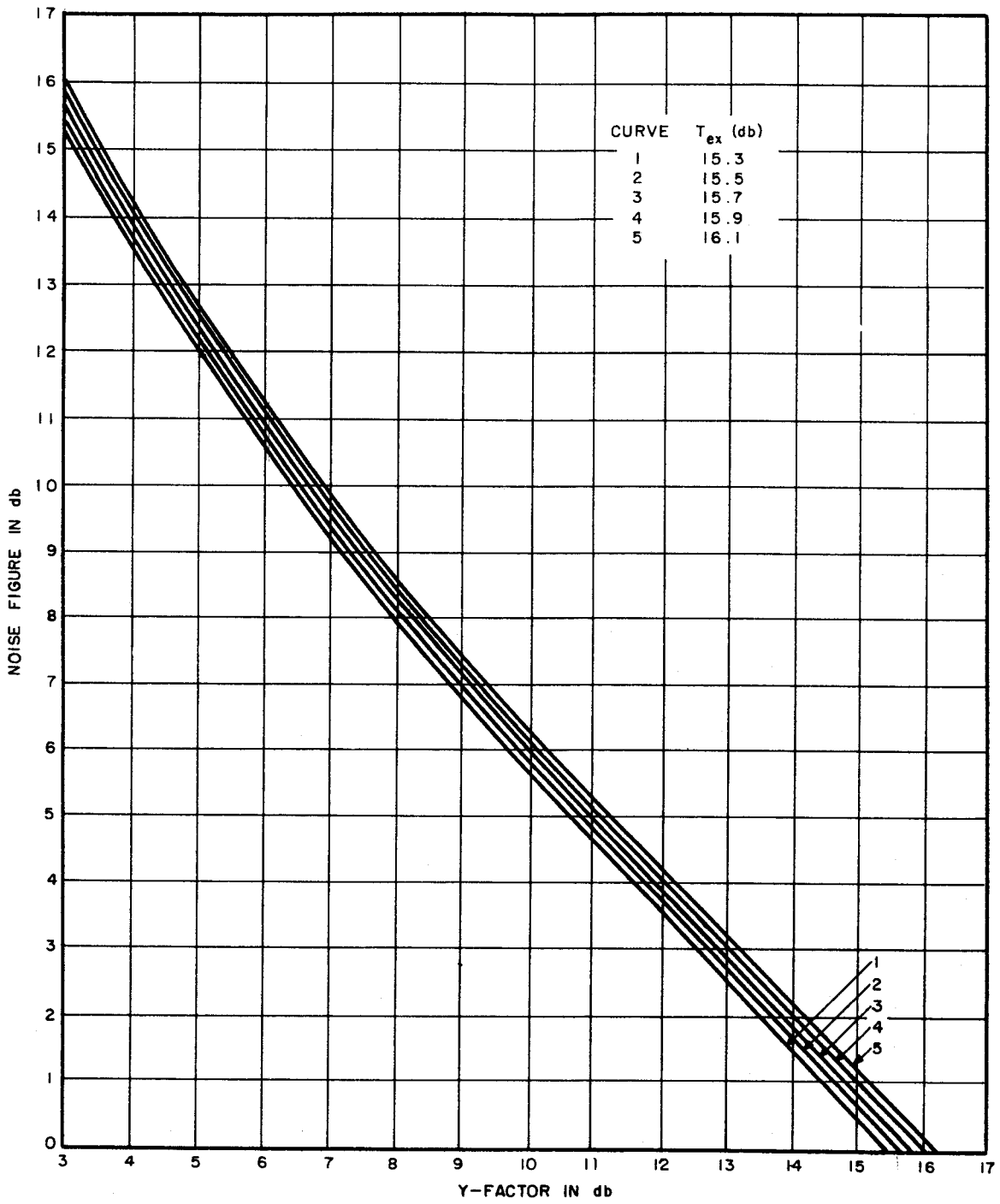

FIGURE 5. MEASURED NOISE FIGURE

The curve shown in Figure 4 represents typical performance for this generator. An accurate determination of the excess noise power may be obtained by measuring the insertion loss of a generator when the gas-discharge tube is fired and again when it is unfired.

These values of hot and cold insertion loss can be used to determine the decrease in the excess noise power of the noise generator by referring to Figure 6. The correction factor obtained from these curves should be subtracted from the excess noise power of the actual tube used in the noise generator, which is 15.6 db.

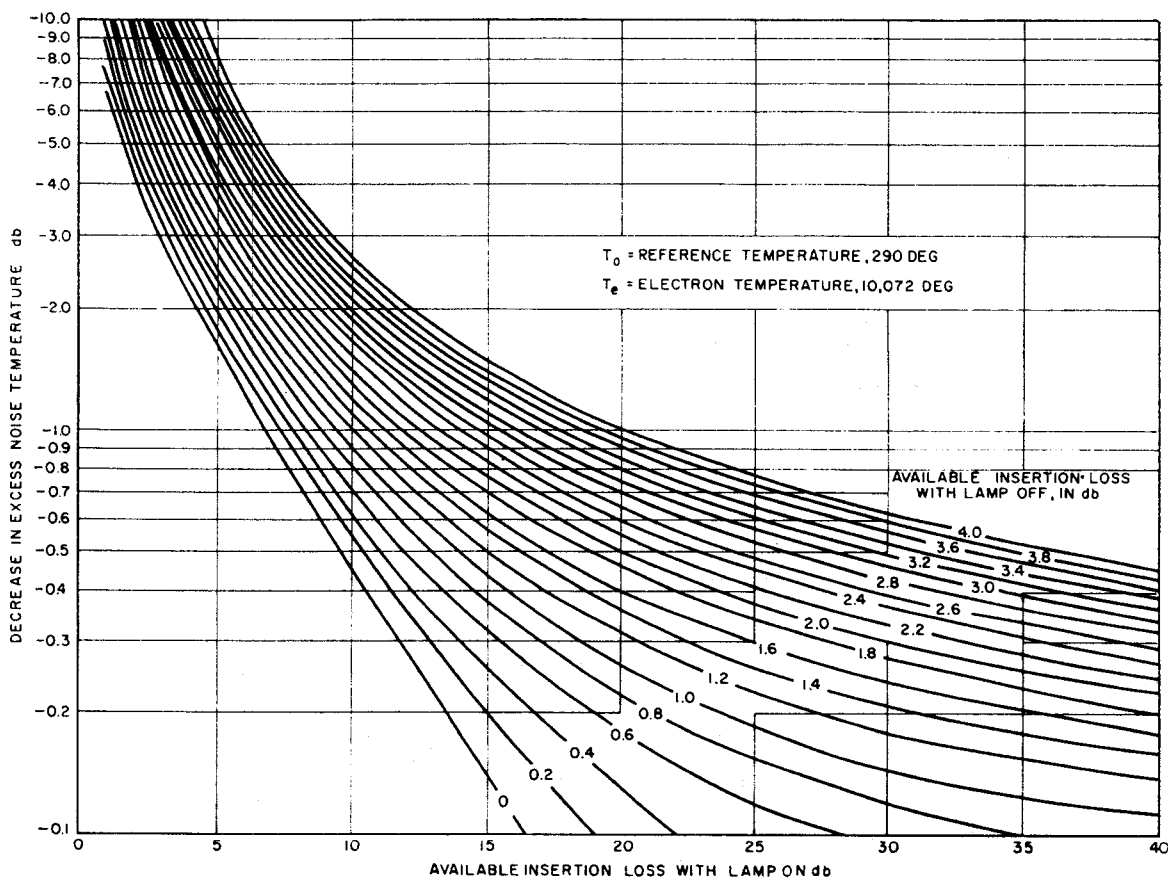

FIGURE 6. DECREASE IN RELATIVE EXCESS NOISE TEMPERATURE AS A FUNCTION OF NOISE SOURCE INSERTION LOSS

If B_O/B is not equal to 1, a correction must be added (in db) to the value obtained in Figure 6 equal to $10 \log (B_O/B)$. For example, if the receiver has an image response equal to the desired signal response ($B_O = 2B$), the correction to be added is 3 db.

Usually, the most accurate means for determining Y is to use the IF attenuation method, as indicated in Figure 7. An IF output is taken from the receiver under test at some stage where significant additional noise will not be contributed. With the noise generator off, the output from the postamplifier is adjusted to obtain a convenient reading on the output indicator. The generator is then turned on, and the IF attenuator is adjusted to return the output indicator to the preceding value. The change in the attenuator readings between the two conditions is precisely the Y-factor, provided that all circuits up to the attenuator are linear and that the gain of the overall system has remained constant during the two measurements.

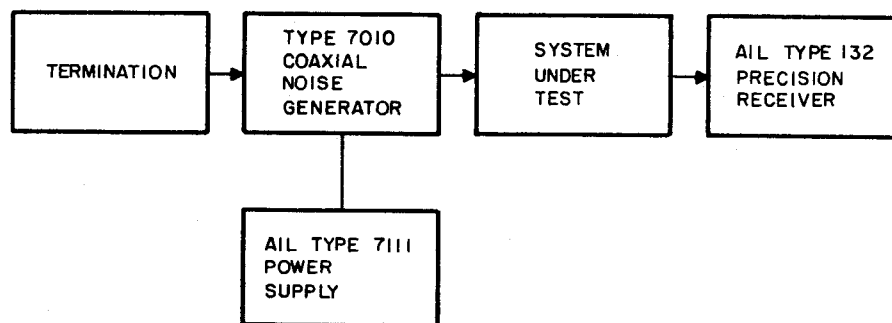

FIGURE 7. SETUP FOR MEASURING NOISE FIGURE

The accuracy of the measurement also depends on the accuracy of the attenuator that is used. The AIL Type 30 IF Attenuator is excellent in this application. This attenuator has been incorporated in a 30-Mc (or 60-Mc) receiver (AIL Type 132), which also includes the postamplifier and output indicator.

To obtain accurate results, the Type 7010 should be terminated in a matched load with an SWR of less than 1.10. Otherwise, the impedance of the generator will not be well-matched in the "on" and "off" conditions, and the measurements may be invalid.

In some cases, it is desirable to be able to align the receiver under test before each measurement. In this case, a carefully matched 20-db pad can be connected to the unused terminal in place of the 50-ohm termination, and a signal can then be fed through the pad and noise generator to the receiver.

If the generator is to be used continuously, it may cause the termination temperature (T_1) to rise significantly above 290°K . If extreme accuracy is required and if the receiver noise figure is low (below 6 db), this increase in termination temperature may require a correction to the measured noise figure computed from equation 2. Equation 1 must then be used; the correction is seldom significant.

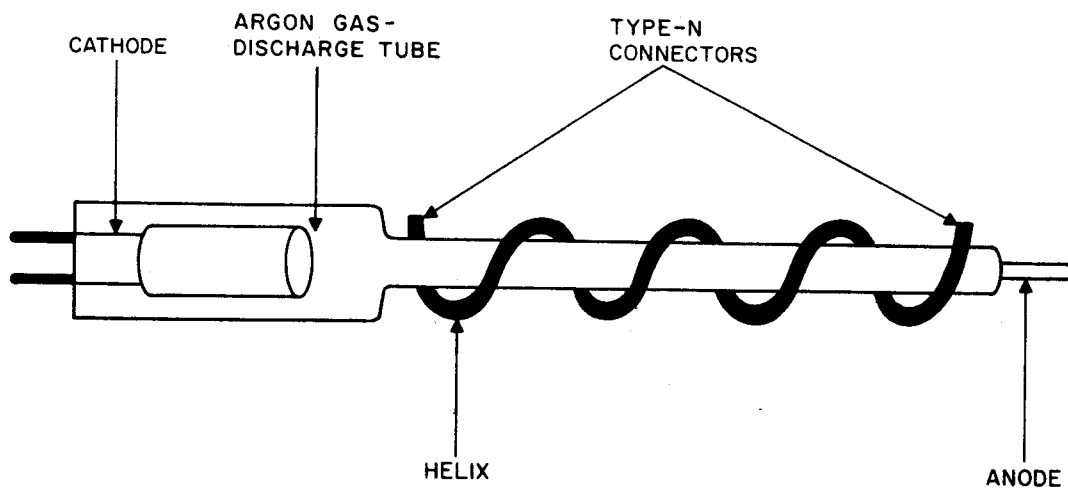

FIGURE 8. TYPE 7010 NOISE GENERATOR, SCHEMATIC DIAGRAM

V. MAINTENANCE

Maintenance of the Type 7010 Noise Generator is limited to replacement of the argon-filled gas-discharge tube.

To replace the tube, proceed as follows:

1. Unscrew knurled retainer on cathode end.
2. Grasp cathode connector and unscrew it from the main block.

CAUTION

Hold the tube with two fingers by the glass portion--not by the base. The amount of force required to remove the tube could possibly be sufficient to break the seal between the tube and its base.

3. Carefully remove tube from mount.
4. To insert a new tube, reverse this procedure.

If any further repairs are necessary, return the noise generator to the factory in accordance with the following instructions.

Write first to the AIL Sales Department, giving complete information concerning the nature of the failure and the manner in which the equipment was used when failure occurred. Also provide the TYPE and SERIAL NUMBERS of the unit. Special instructions will then be supplied to the customer for shipping the unit back for repairs. All equipment should be packed and shipped, in accordance with these instructions, with transportation charges prepaid. A failure report should accompany shipment of the equipment.

VI. PARTS LIST

The argon-filled gas-discharge tube (AIL Part No. 113676) is the only replaceable part in the Type 7010 Coaxial Noise Generator.

VII. AIL TYPE 7011 NOISE GENERATOR

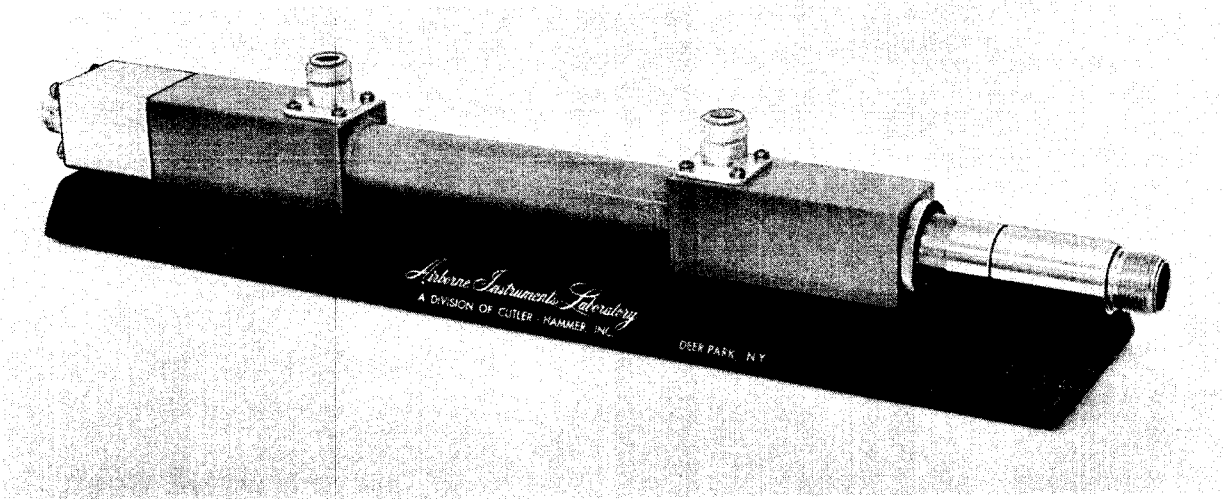
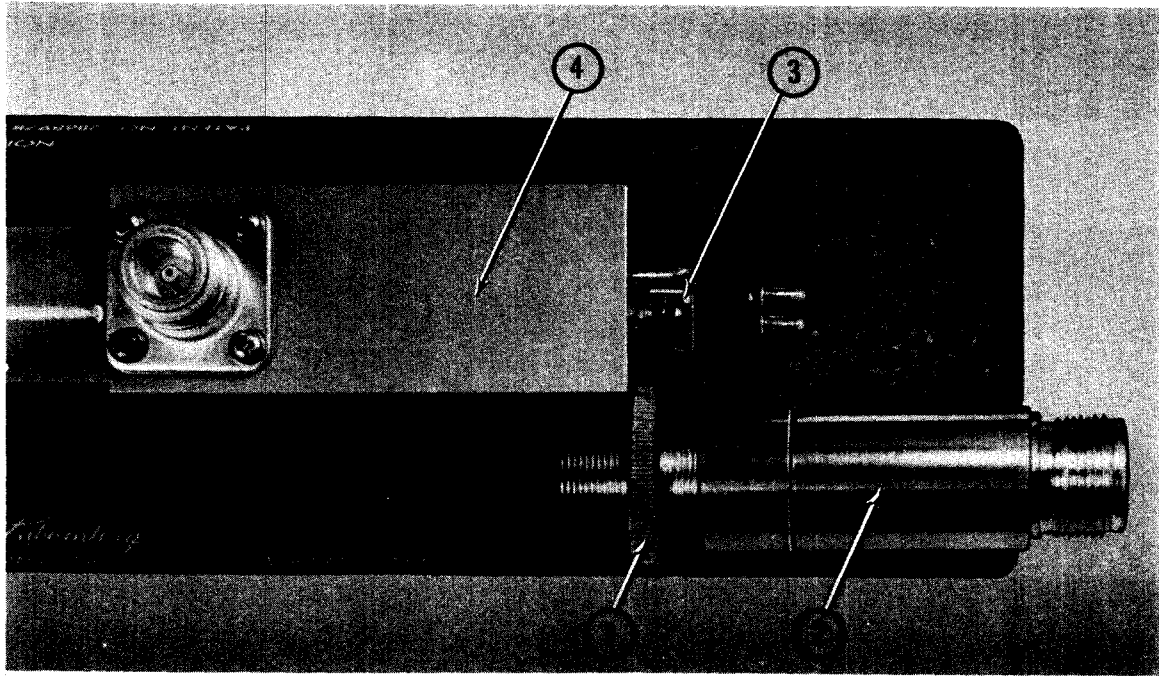

FIGURE 9. TYPE 7011 COAXIAL NOISE GENERATOR

To replace the argon-filled gas-discharge tube (AIL Part No. 113676) in the Type 7011 Noise Generator (Figure 9) proceed as follows:

1. Loosen lock ring (1, Figure 10).
2. Remove cathode connector (2).
3. Remove noise tube (3).
4. Insert new tube.
5. Position cathode connector as shown in Figure 10.
6. Adjust lock ring until groove on cathode connector lines up with end of tube pins when tube is pushed in against anode spring.
7. Insert cathode connector into housing until lock ring is seated against cathode housing (4).



1. LOCK RING
2. CATHODE CONNECTOR

3. NOISE TUBE
4. CATHODE HOUSING

FIGURE 10. LOCK RING PLACEMENT