

SERIAL NUMBER:

315253



ANTENNAS, INC.

10-30-7LPA

**KLM Antennas, Inc
Post Office Box 694
Monroe, Washington 98272
Tel: (360)794-2923
Fax: (360)794-0294
E-Mail: klm_antennas@msn.com**



ANTENNAS, INC.

10-30-7 LPA

An efficient trapless beam, the 10-30-7 LPA provides good gain and F/B ratios from 10-30 MHz. This included the 20, 15 and 10 meter amateur bands, as well as WW1 on 10 and 15 MHz, MARS on 13, 14, 15, 17 and 19 MHz, and 27 MHz CB. A KLM 3-60 4:1 balun is supplied with the antenna for direct 50 ohm coax feed. No tuning or matching are necessary.

SPECIFICATIONS

Frequency of Operation	10 to 30 MHz
Gain	7 dBd Typical
Feed Impedance	50 ohms with balun
F/B	15 dB
VSWR	Less than 2:1 typical
Max. Element Length	43'
Boom Length/Diameter	30' / 3" O.D.
Elements	7
Turning Radius	26'
Wind Area	8.25 square feet
Weight	70 pounds

KLM 10-30-7LPA

DIMENSION SHEET

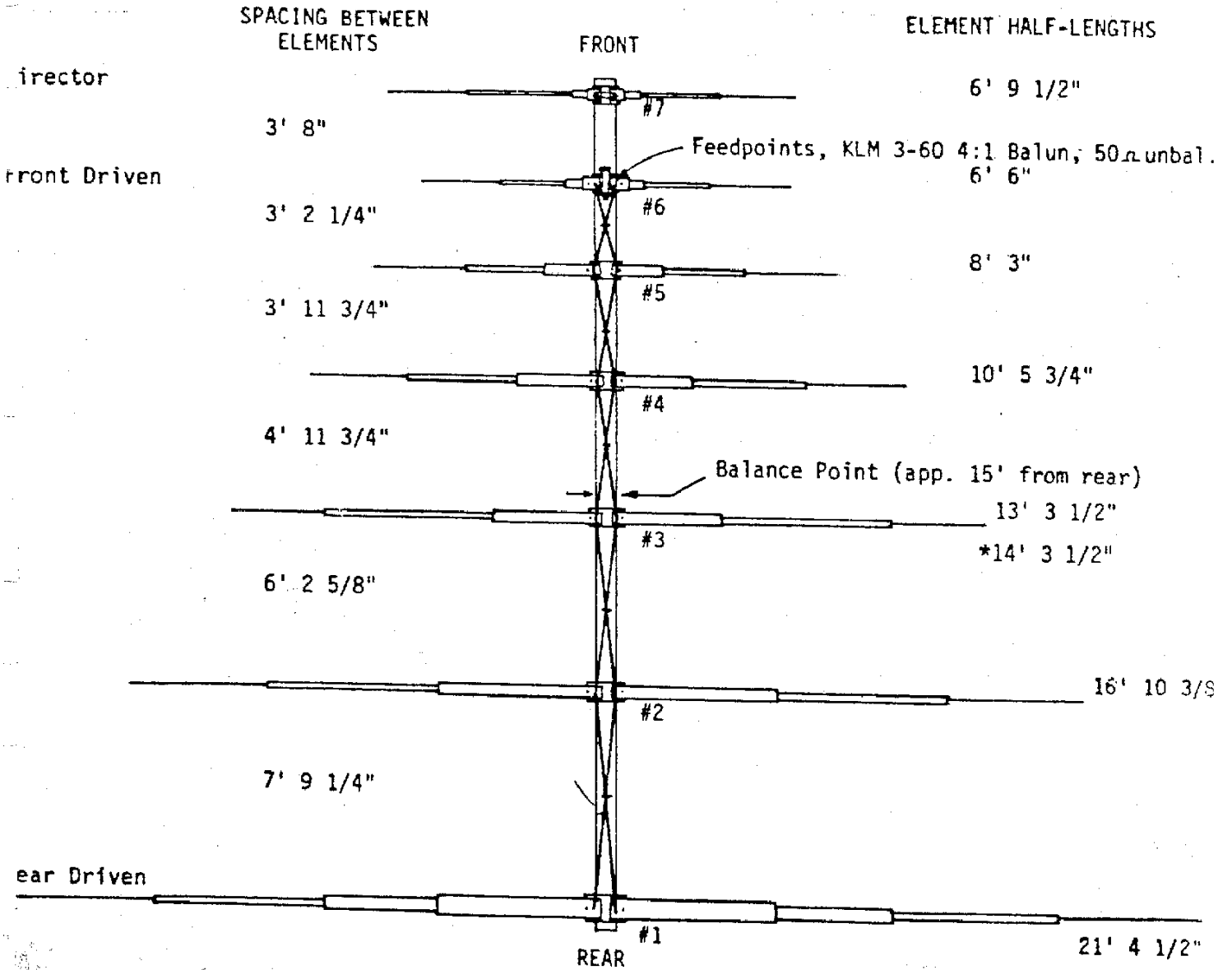

* FOR IMPROVED AMATEUR OPERATION, 14.0-14.5 MHz.

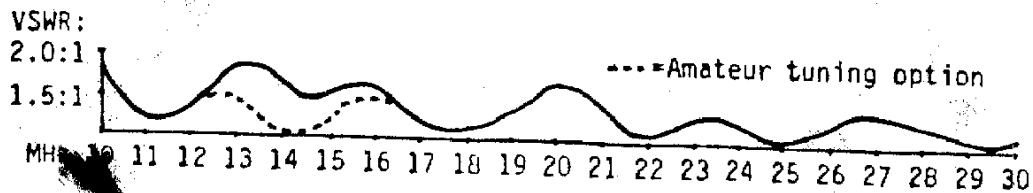

KLM 10-30-7LPA

DIMENSION SHEET

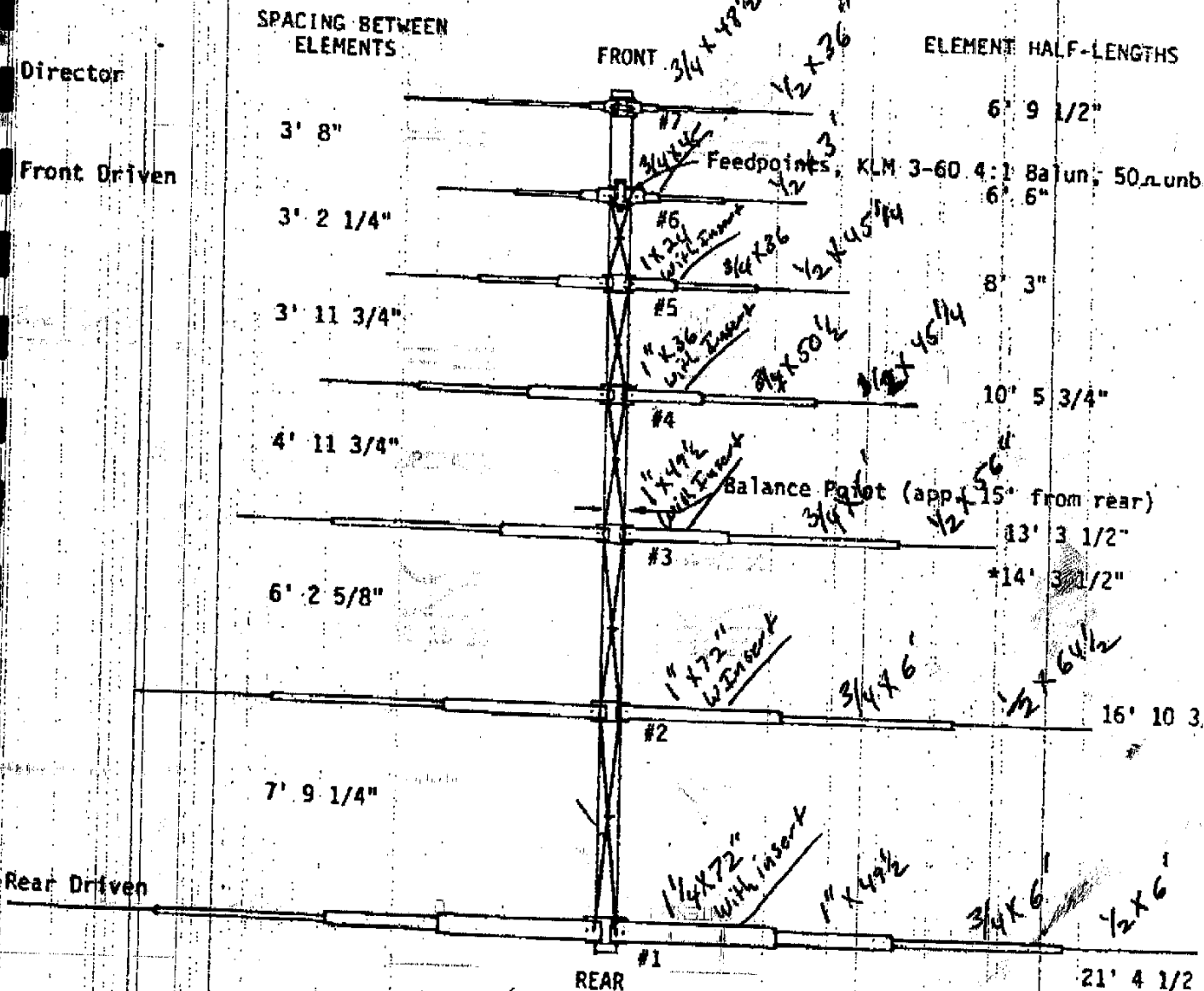

* FOR IMPROVED AMATEUR OPERATION, 14.0-14.5 MHz.

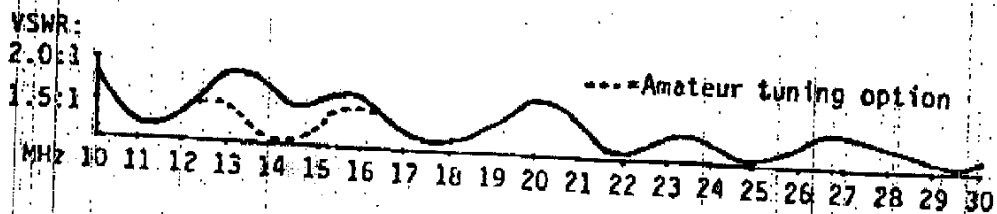

BEFORE YOU BEGIN

Select an assembly area large enough to comfortably accommodate overall antenna dimensions. A shallow box is handy for holding and sorting the smaller hardware, as is a marking pen for identifying components.

Some simple tools are required: A tape measure, screwdriver and a set of spin-tite and socket or end wrenches. Common nut sizes are:

3/8".....	10-32 Hdwe	1/2".....	5/16-18 Hdwe
7/16".....	1/4-20 Hdwe	9/16".....	3/8-16 Hdwe

To avoid damage to antenna components, be aware that most hardware need only be moderately hand tightened with screwdriver or spin-tite to be secure. When using tools with mechanical leverage such as socket or end wrenches, care must be taken not to over-torque nuts and damage components.

Thoroughly unpack shipping box and check components and hardware against the Parts List. If there is a difference, look for a "Factory Update/Change" sheet accompanying the assembly instructions prior to contacting KLM.

For easiest and fastest assembly, take a few moments before starting to familiarize yourself with the assembly guide and the antenna components.

BOOM ASSEMBLY (For Heavy Duty Boom, See Supplemental Sheet)

Lay out 3" O.D. boom sections on the ground as shown in the sketch below.

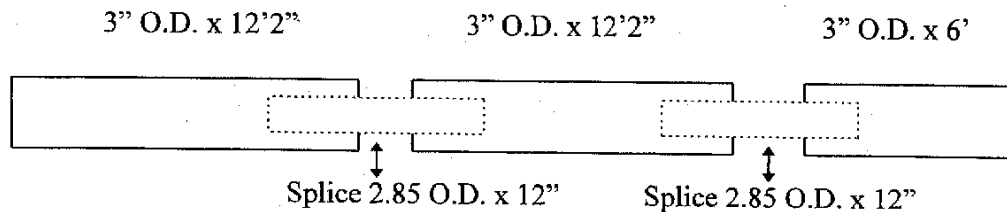

To assemble, insert the swaged (shaped) end on the section into the appropriate straight section and align the bolt holes. Each joint is cross bolted with two 1/4-20 x 3 1/2" bolts, lockwashers and nuts. Torque nuts up to 10ft/lbs.

ASSEMBLY OF ELEMENT

Each complete antenna element is composed of two halves of telescoping aluminum tubing secured in the middle by a Lexan Insulator. Reflector/director element halves are electrically joined by a short jumper strap. The driven elements are interconnected by phasing straps and the front driven element provides the feedpoints via an appropriate balun, for the antenna.

Inner tubing sections on each element half are telescoped (or overlapped) three inches. Overlap of the tip sections will vary slightly because the over-all element half length is the critical electrical dimension and the tip section is adjusted as necessary to achieve it.

Inner tubing sections on each element half are telescoped (or overlapped) three inches. Overlap of the tip sections will vary slightly because the over-all element half length is the critical electrical dimension and the tip section is adjusted as necessary to achieve it.

The smaller inside section of each telescoping joint is always coated lightly with Conductive Paste to promote good long lasting electrical connections.

Each telescoping section is secured with a specified band clamp located 1/16" back from slit end of larger tubing. See the sketch below.

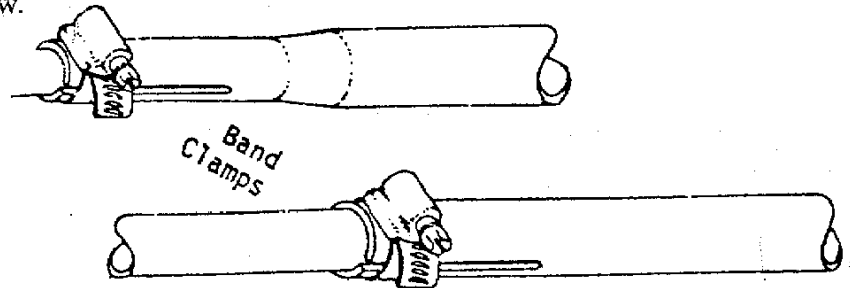

The chart below lists the tubing lengths supplied for each element half, the proper band clamp for each overlap and the correct element half length (adjust the tip section). Remember to use Conductive paste at each overlap and securely tighten clamps until tubing cannot be pulled out or rotated. Pair up element halves as they are completed to avoid mix-ups.

ELEMENT #	TUBING 1 1/4" O.D.	CLAMP	TUBING 1" O.D.	TUBING 7/8"	CLAMP	TUBING 3/4" O.D.	CLAMP	TUBING 1/2" O.D.	TOTAL ELEMENT HALF
#1 Rear Driven	6'	M-16	4' 1 1/2"		M-8/10	6'	5/8" Com	6'	21' 4 1/2"
#2 Driven	6'	M-16	6'	34" Insert	M-8/10	6'	5/8" Com	5' 4 3/8"	16' 10 3/8"
#3 Driven	6'	M-16	4' 1 1/2"	18" Insert	M-8/10	6'	5/8" Com	4' 8"	13' 3 1/2"*
#4 Driven	6'	M-16	3'	12" Insert	M-8/10	4' 2 1/2"	5/8" Com	3' 9 1/4"	10' 5 3/4"
#5 Driven	6'	M-16	2'	6" Insert	M-8/10	3'	5/8" Com	3' 9 1/4"	8' 3"
#6 Driven	6'	M-16	6" and	12 Sleeves		3' 9"	5/8" Com	3'	6' 6"
#7 Director	6'	M-16	6" and	12 Sleeves		4' 1/2"	5/8" Com	3'	6' 9 1/2"

* Standard commercial setting. For improved VSWR for 4 to 14' 3 1/2". See VSWR sketch bottom of Page 2A:

PREPARING THE INSULATOR

The large HTM-350 band clamps are bolted into the underside of the Polycarbonate Insulator with 1/4-20 x 3 1/2" bolts, lockwashers and nuts (stainless steel) as shown in the drawing below. Install in all the insulators.

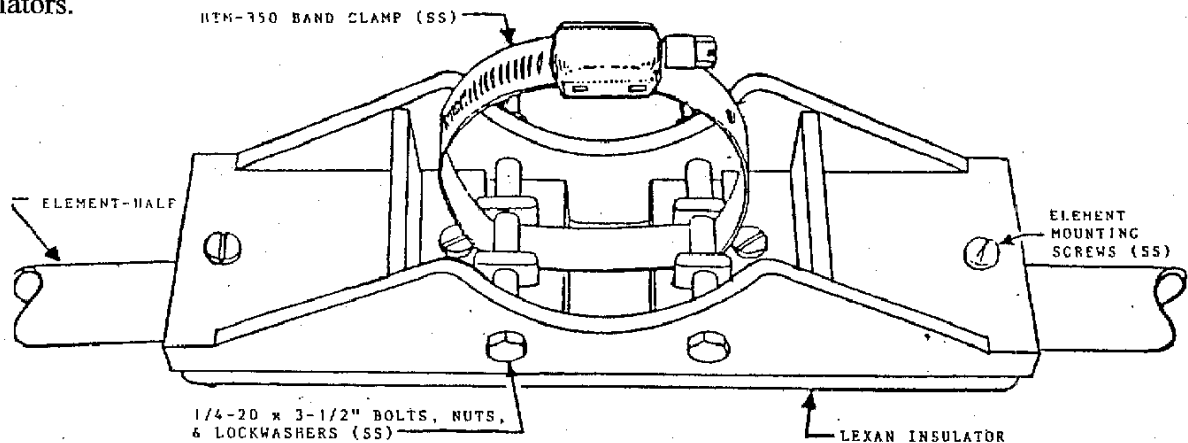

IMPORTANT NOTE: The INSULATOR is made of Polycarbonate plastic, which is one of the toughest materials available,...strong and firm,...flexible but not brittle. It does not expand or contract with heat or cold (+-.005) however, the metal fasteners that you use with this insulator change in size with temperature variance. **THEREFORE... MAKE SURE THE NUTS ARE ONLY TIGHTENED UNTIL THE LOCKWASHERS START TO CLOSE. WHEN BOLTS ARE TOO TIGHT, THEY CREATE GREAT PRESSURE ON THE LEXAN PLASTIC WHICH CAUSES THE INSULATOR TO SLOWLY FRACTURE AND THEN FAIL.**

The KLM Polycarbonate insulator has been designed to accommodate up to 1 1/2" O.D. elements. Antennas using smaller O.D. elements are supplied with half-round reduction sections. These are placed in the two element channels on the top of the insulator with the thicker ends toward the center as shown in the drawing below. Prepare all insulator's.

(Element #1: 1 1/2" to 1 1/4" sections
All other elements: 1 1/2" to 1" sections

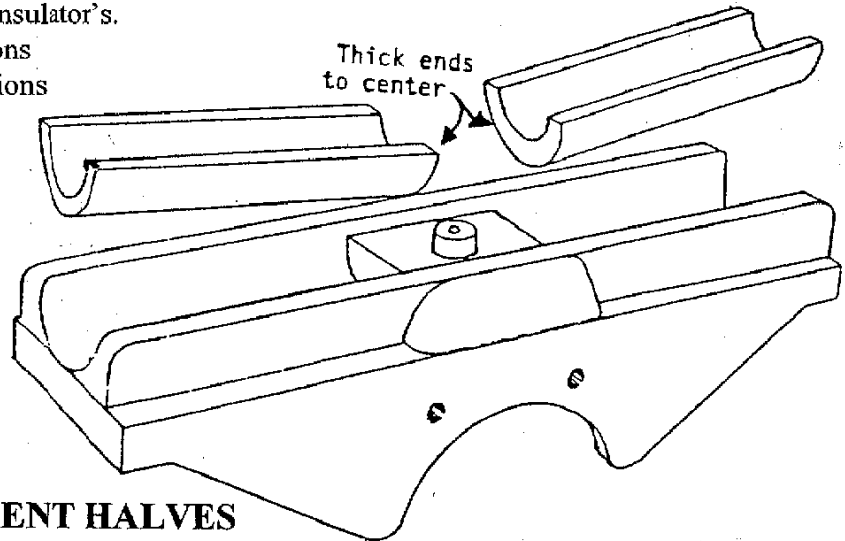

MOUNTING THE ELEMENT HALVES

Take each pair of element halves, in sequence and attach them to the insulators. Check that reinforcing inserts in element half butts are re flush and mounting holes are aligned. Lay the element half butt into the insulator channel. Insert 10-32 x 2 1/2" screws from bottom of insulator and secure above element butt with 10-32 nuts and lockwashers. Holes in element half butt will align one way only (drilled slightly off square to compensate for element "lift" designed into insulator). If screws are not an easy fit, rotate element half butt 180 degrees and repeat.

Assembly all element halves to insulators and set each complete element aside, in order.

The Director Element, #7 at front of boom, requires a 1/2" x 3 3/4" jumper strap between element halves. Bow the strap slightly, as needed, to fit the two inner most element mounting screw studs and secure with additional lockwashers and nuts. See sketch below.

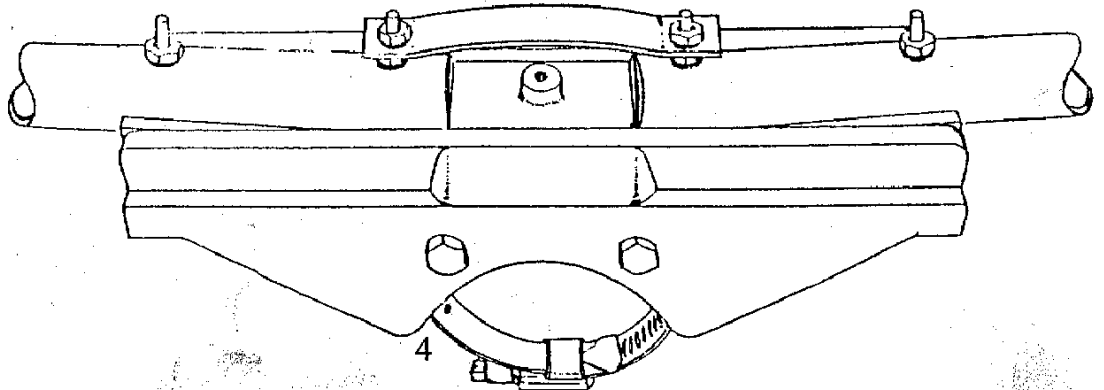

MOUNTING THE ELEMENT TO THE BOOM

Roll the boom until assembly bolts are 45 degrees from vertical with bolt heads "up". Center element #1 at two inches from the rear of the boom (about 1/2" of boom should extend beyond the insulator) and securely tighten the HTM-350 clamp. Loosely install the remainder of the elements on the boom according to the dimensions on the drawing on the next page. Align the Director element to #1 and tighten clamp.

DRIVEN ELEMENT CONNECTIONS

All 6 rear elements are "driven" and linked by crossed pairs of 1/2" wide phasing straps. Pair up the phasing straps by length and then slide each pair through two standoffs until centered (see the sketch below).

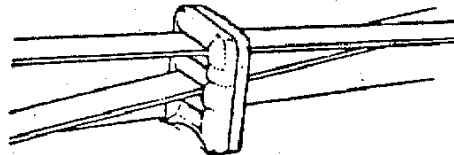

Support boom so that a 1" to 2" droop in the middle is noted. Apply conductive paste to the ends of the longest set of straps (7' 9-13/16") and position between elements #1 and #2. Install straps on inner set of element mounting screws, over the existing nuts. Secure straps on element #1 with additional 10-32 nuts and lockwashers. Add next longest pair of phasing straps (6' 3 1/4") between elements #2 and #3. Secure straps to element #2 as in element #1. Continue installation of remaining phasing straps in the method just described (elements #3 & #4 -5' 3/8"), (elements #4 & #5 -4' 3/8"), (elements #5 & #6 -3' 2 15/16"). **ALL PHASING STRAPS MUST CROSS AT CENTER.** Omit nuts and lockwashers on element #6 until balun is installed.

Attach balun clip to top center of element #6 with a #6 x 3/8" sheet metal screw. Place balun in the clip, connector pointing to boom center. Keep balun terminals as close to the feedpoints as possible but maintain a minimum of 3/8" from balun clip to avoid shorting problems. Apply Conductive paste to coiled balun leads and place over phasing straps. Secure with 10-32 Flatwashers, lockwashers and nuts. See sketch below for correct placement of hardware: **DO NOT SUBSTITUTE THESE LEADS. THE SLIGHT INDUCTANCE PROVIDES NECESSARY MATCHING FOR THE 28-30 MHz REGION.**

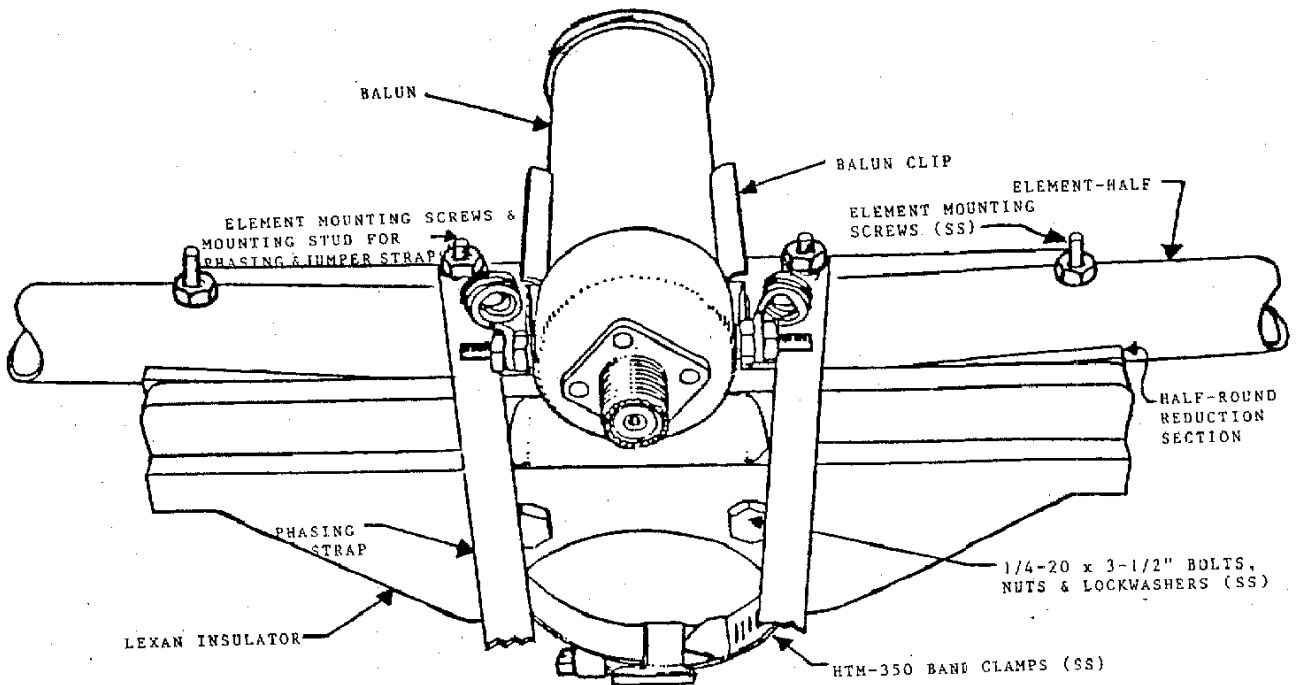

Tensioning of the phasing straps strengthens the boom and minimizes droop. Lightly tighten element #2 clamp and then tap the #2 insulator away from #1 until the phasing straps are taut. Then tighten #2 clamp. Now lightly secure #3 clamp and tap #3 insulator away from #2. When straps are taut tighten #3 clamp. Repeat this process for all the driven elements.

When the front driven element (#6) has been secured, the intermediate driven elements may be loosened to align the elements to element #1. Tension will not be disturbed. Be sure to tighten all clamps securely.

Refer to the Dimension Sheet and check all elements for correct length and spacing.

ATTACHING THE BOOM-TO-MAST PLATE

Temporarily attach feedline to antenna as this will affect balance. Loosely attach the 8" x 9" boom-to-mast plate to the boom about 15' from the rear. Use the two 3" U-bolts supplied. Use the plate to raise the antenna off its supports and then adjust the plate until the exact balance point is determined. Align plate vertically and tighten the U-bolts.

COMPLETING THE ANTENNA

If possible, allow the antenna to sit assembled overnight. The hardware will temperature cycle and various nuts and bolts may require further tightening. Check all nuts, bolts, clamps, etc., and make sure they are all tight and secure. This is a very easy operation on the ground, and very difficult once the antenna has been installed.

If you live in an area of severe weather, or if it is likely the antenna elements will snag on trees, guy wires, etc., during installation, it is recommended that the elements be additionally secured in the

following manner. Drill a #36 pilot hole into the boom through the existing hole in the HTM-350 clamp band and screw in a #6 x 3/8" sheet metal screw. Repeat for all elements (screws are supplied).

Plastic plugs are supplied for the boom ends. They keep out birds and reduce wind noise. Cut or drill a small drain hole in each near the bottom edge before installing.

Connect 50 ohm coax to balun and route back under boom to the mounting plate. Tape or strap every 3 to 4'. To avoid problems, use only quality coax of known 50 ohm impedance (such as Times FM-8, Belden 8214, Columbia 1198, RG 213, RG 214, etc.).

The antenna's boom-to-mast plate is drilled for a 2" O.D. mast. Install with four 2" U-bolts. Mounting this antenna on a mast with other HF antennas is not recommended. For special mounting requirements, contact KLM.

METRIC CONVERSION

When converting American measurements to metric use the scale and chart below to identify lengths of bolts, diameters of tubes, etc. The American inch (1") and foot (1') can be converted in this way.

1" (inch) = 2.54 cm
1' (foot) = 30.48 cm

Example: 48" x 2.54 = 121.92 cm

Fractional Inch Millimeters

1 / 16.....	1.588
1 / 8.....	3.175
3 / 16.....	4.700
1 / 4.....	6.350
5 / 16.....	7.937
3 / 8.....	9.525
7 / 16.....	11.112
1 / 2.....	12.700
9 / 16.....	14.288
5 / 8.....	15.875
11 / 16.....	17.463
3 / 4.....	19.050
13 / 16.....	20.638
7 / 8.....	22.225
15 / 16.....	23.813
1.....	25.400



PARTS LIST
10-30-7 LPA

DESCRIPTION	PART#	QTY
*Boom, 3" O.D. x 12' 2", End drilled	T3000	1
*Boom, 3" O.D. x 12' 2", Drilled both ends	T3000	1
*Boom, 3" O.D. x 6', Drilled one end	T3000	1
Splice, 2.85 O.D. x 12", Straight	T0285	2
Element, 1 1/4" O.D. x 72", Swaged	T1140	2
With Insert, 1 1/8" O.D. x 34"	T1180	2
Element, 1" O.D. x 72", Swaged	T1000	2
With Insert, 7/8" O.D. x 34"	T0780	2
Element, 1" O.D. x 49 1/2", Swaged	T1000	2
With Insert, 7/8" O.D. X 18"	T0780	2
Element, 1" O.D. x 49 1/2"	T1000	2
Element, 1" O.D. x 36", Swaged	T1000	2
With Insert, 7/8" O.D. x 12"	T0780	2
Element, 1" O.D. x 24", Swaged	T1000	2
With Insert, 7/8" O.D. x 6"	T0780	2
Element, 3/4" O.D. x 72", Swaged	T0340	6
Element, 3/4" O.D. x 50 1/2", Swaged	T0340	2
Element, 3/4" O.D. x 48 1/2", Swaged	T0340	2
With Sleeve, 1" O.D. x 6"	T1000	2
With Sleeve, 7/8" O.D. x 12"	T0780	2
Element, 3/4" O.D. x 45", Swaged	T0340	2
With Sleeve, 1" O.D. x 6"	T1000	2
With Sleeve, 7/8" O.D. x 12"	T0780	2
Element, 3/4" O.D. x 36", Swaged	T0340	2
Element, 1/2" O.D. x 72"	T0120	2
Element, 1/2" O.D. x 64 3/8"	T0120	2
Element, 1/2" O.D. x 56"	T0120	2
Element, 1/2" O.D. x 45 1/4"	T0120	4
Element, 1/2" O.D. x 36"	T0120	4
Phasing Straps, 1/2" x 93 13/16"	S0120	2
Phasing Straps, 1/2" x 75 1/4"	S0120	2
Phasing Straps, 1/2" x 60 3/8"	S0120	2
Phasing Straps, 1/2" x 48 3/8"	S0120	2
Phasing Straps, 1/2" x 38 15/16"	S0120	2
Boom-to-mast plate, 8" x 9" x 1/4"	P0809	1
Balun, 3-60 4:1	B36041	1

PARTS LIST (Cont.)
10-30-7 LPA

DESCRIPTION	PART#	QTY
<u>HARDWARE BAG #1</u>		
Screws, #6 x 3/8"	28000	9
Screws, 10-32 x 2 1/2"	28025	29
Nuts, 10-32	28203	44
Lockwashers, #10	28353	44
Flatwashers, #10	28303	2
Nuts, 3/8-16	28205	4
Lockwashers, 3/8"	28355	4
Nuts, 5/16-18	28206	8
Lockwashers, 5/16"	28356	8
Jumper Strap, 1/2" x 3 3/4"	S0120	1
Coil Balun Lead	B1207	2
Stand-Off Phasing Straps	PL66121	11
<u>HARDWARE BAG #2</u>		
Bolts, 1/4-20 x 3 1/2"	28526	22
Nuts, 1/4-20	28204	22
Lockwashers, 1/4"	28354	22
<u>HARDWARE BAG #3</u>		
Clamps, M-16	28477	2
Clamps, M-10	28488	14
Clamps, M-6	28200	14
Clamps, HTM-350	28487	7
<u>HARDWARE BAG #4</u>		
Insulator Inserts, 1 1/2" - 1 1/4"	PL66108	2
Insulator Inserts, 1 1/2" - 1"	PL66135	12
<u>HARDWARE BAG #5</u>		
U-Bolts & Cradles, 3"	28410	2
U-Bolts & Cradles, 2"	28402	4
<u>HARDWARE BAG #6</u>		
Insulators, 1 1/2" - 3"	PL66139A	7
Conductive Paste, 1 oz	16001	1
*Boom Caps, 3"	PL66133	2



ANTENNAS, INC.

BALUNS

Your KLM Antennas balun has been fully tested, both electrically and physically, before leaving the factory. To maximize the performance and efficiency of your balun, please note the following recommendations.

- 1) Keep the lead lengths from balun to feedpoints as short as possible. Un-necessary length can upset VSWR, bandwidth, etc. Solder lugs are a good idea too.
- 2) Be sure studs on HF balun are at least 3/8" from other antenna hardware.
- 3) When stacking two or more antennas, use balun stud identified with black dot on hot side on HF or center lead (VHF/UHF) as key for proper phasing (see sketch below).

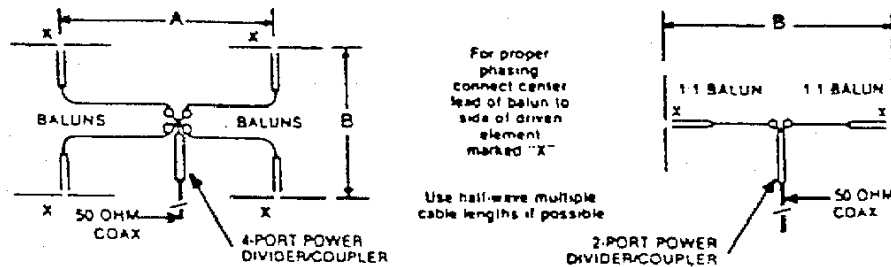

- 4) KLM HF/VHF Baluns are normally supplied with SO-239 type connectors. Use only PL-259 connectors with them. Assembly of PL-259 connectors (for two types of coax) are shown below.

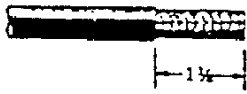

1 1/8"

1) Cut end of cable even. Remove jacket 1 1/8" do not nick braid.



3/4" 1/16" X

2) Bare 3/4" of center conductor, do not nick conductor. Trim braided shield 1/16" and tin Slide coupling ring on cable.



3) Screw the plug assembly on cable. Solder plug assembly to braid through solder holes. Solder conductor to contact sleeve.

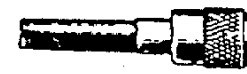

4) Screw coupling ring on assembly.



7/32"

1) Cut end of cable even. Remove jacket 21/32" do not nick braid. Slide coupling ring and adapter on cable.

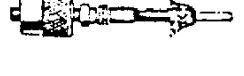

2) Fan braid slightly and fold back over cable



3) Compress braid around cable. Position adapter to dimension shown. Press braid down over body of adapter and trim.



1/2" 1/4" 1 1/8"

4) Bare 1/2" of center conductor, do not nick conductor. Pre-tin exposed center conductor



5) Screw the plug assembly on adapter. Solder braid to shell through solder holes.



6) Screw coupling ring on back shell.

IMPORTANT NOTE: If your balun is supplied with type "N" connectors (HF/VHF option-UHF standard), PLEASE READ ON...

Type "N" Connectors are noted for their low loss and good weather seal characteristics, but they must be carefully mated and only to other cleaned and carefully assembled type "N" connectors.

KLM Antennas gives 90 day materials and workmanship warranty and does not cover type "N" center pins bent or broken during installation or field use, so please read the following application notes carefully. (See next page) RG-8/U Cable Assembly to connectors.

FOR BALUNS WITH TYPE "N" CONNECTORS

- 1) Use only type "N" connectors with your balun. Do not use PL-259 (SO-239) type connectors. They will ruin it.
- 2) Carefully mate Type "N" connectors straight on. Jamming them together at angles will damage or break the center pins.
- 3) Carefully assemble your own type "N" connectors. See below for step-by-step details.



A) Cut end of cable even



B) Remove vinyl jacket 1/2" do not nick braid.

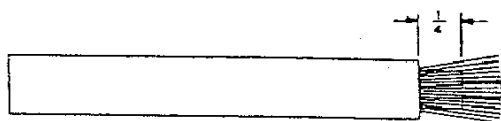

C) Comb out copper braid as shown. Bare 1/4" of center conductor-do not nick conductor.

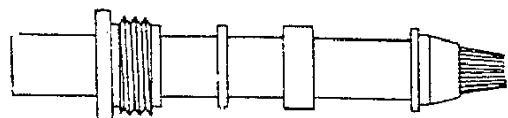

D) Taper braid as shown. Slide nut, washer and gasket on vinyl jacket. Slide clamp on braid.

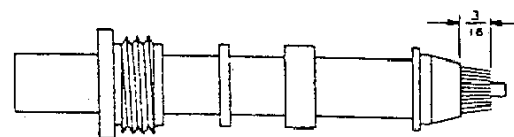

E) With clamp in place, trim braid as shown.

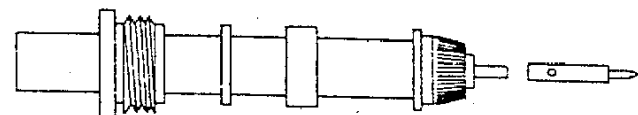

F) Fold copper braid back on clamp. Tin center conductor, using minimum amount of heat.

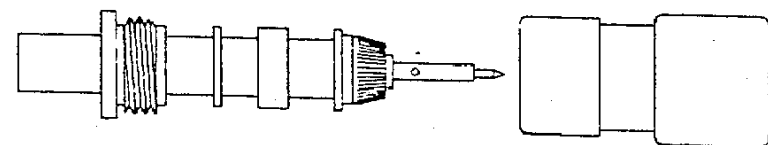

G) Holding contact with pliers, soft solder contact to center conductor. It is imperative that back end of contact be flush with polyethylene dielectric. Do not use excess solder. Wipe clean - see that end of cable insulator is clean and free of solder, rosin and foreign material.

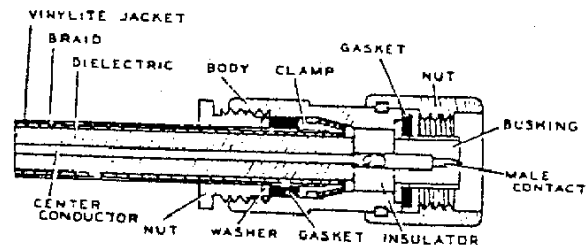

H) Slide body into place carefully so that center conductor enters hole in insulator. Face of cable dielectric must fit flush against insulator. Properly tighten body and nut with wrenches.

NOTES: This assembly procedure applies to type "N" plugs. The procedure for jacks is the same except for the use of a female contact and a jack body.