

SCHEMATIC DIAGRAM - 1 (MAIN)

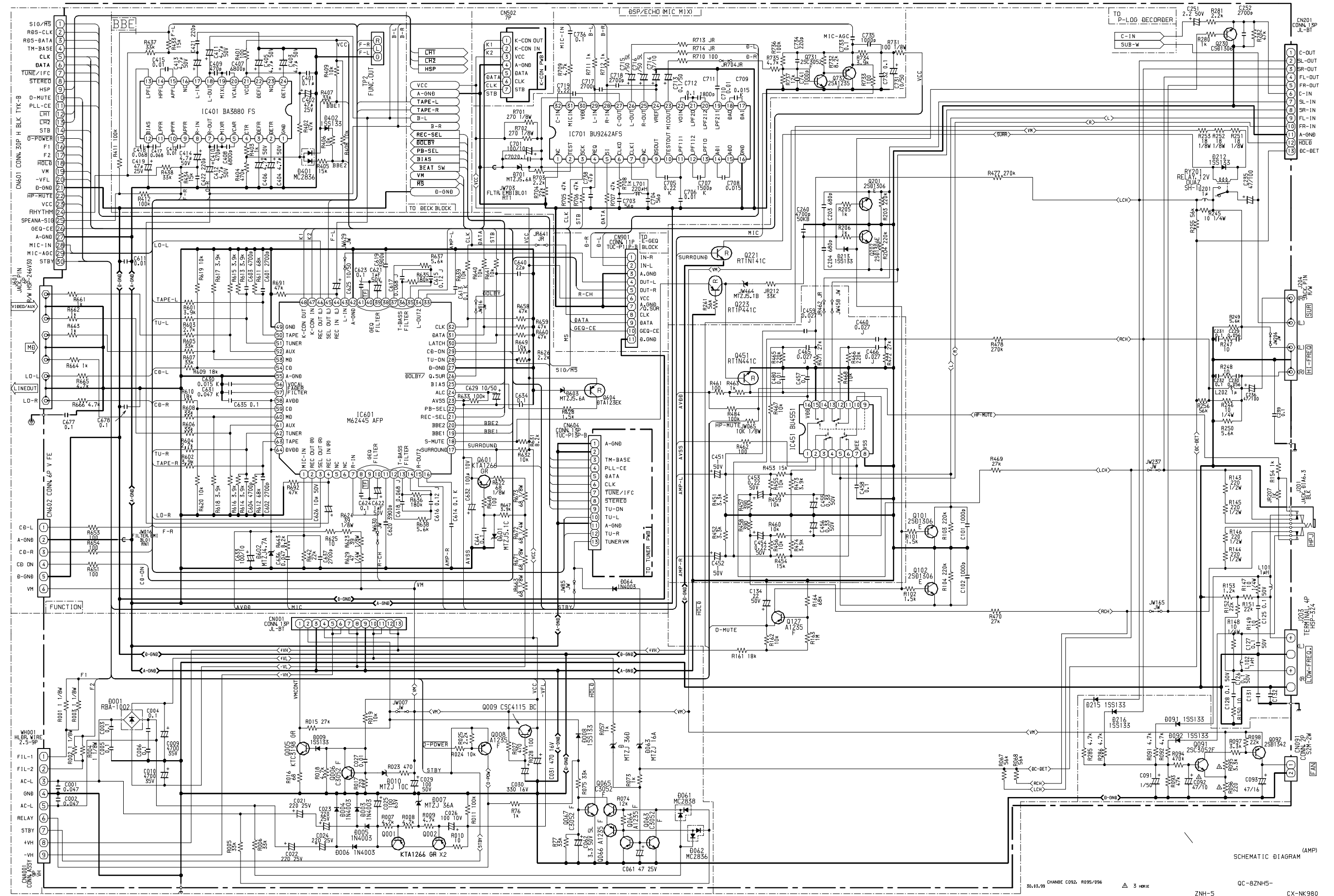

B-ZNH-SM1N-HR (P1)

SCHEMATIC DIAGRAM - 2 (FRONT)

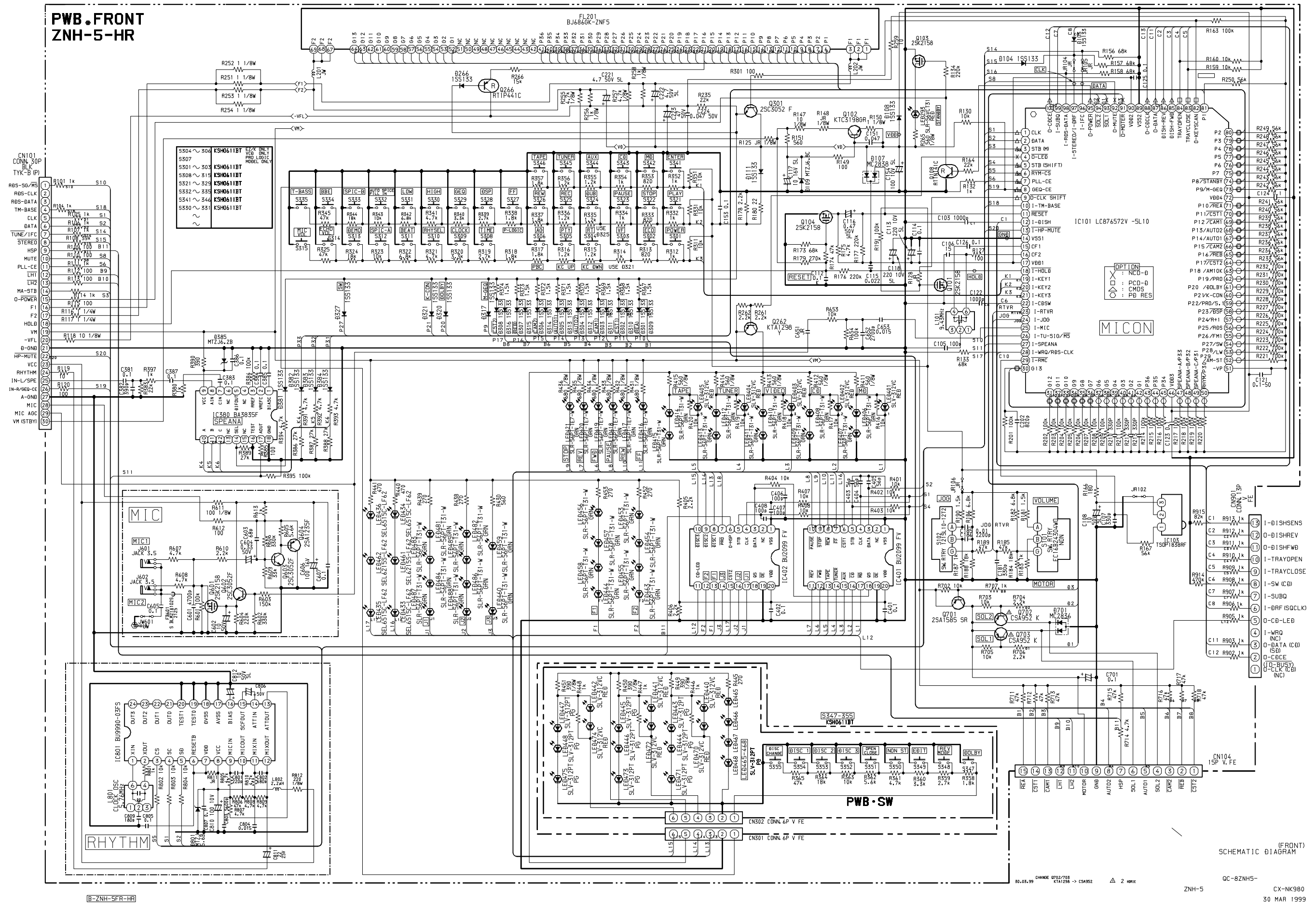

(FRONT)  
SCHEMATIC DIAGRAM

SCHEMATIC DIAGRAM - 3 (AMP)

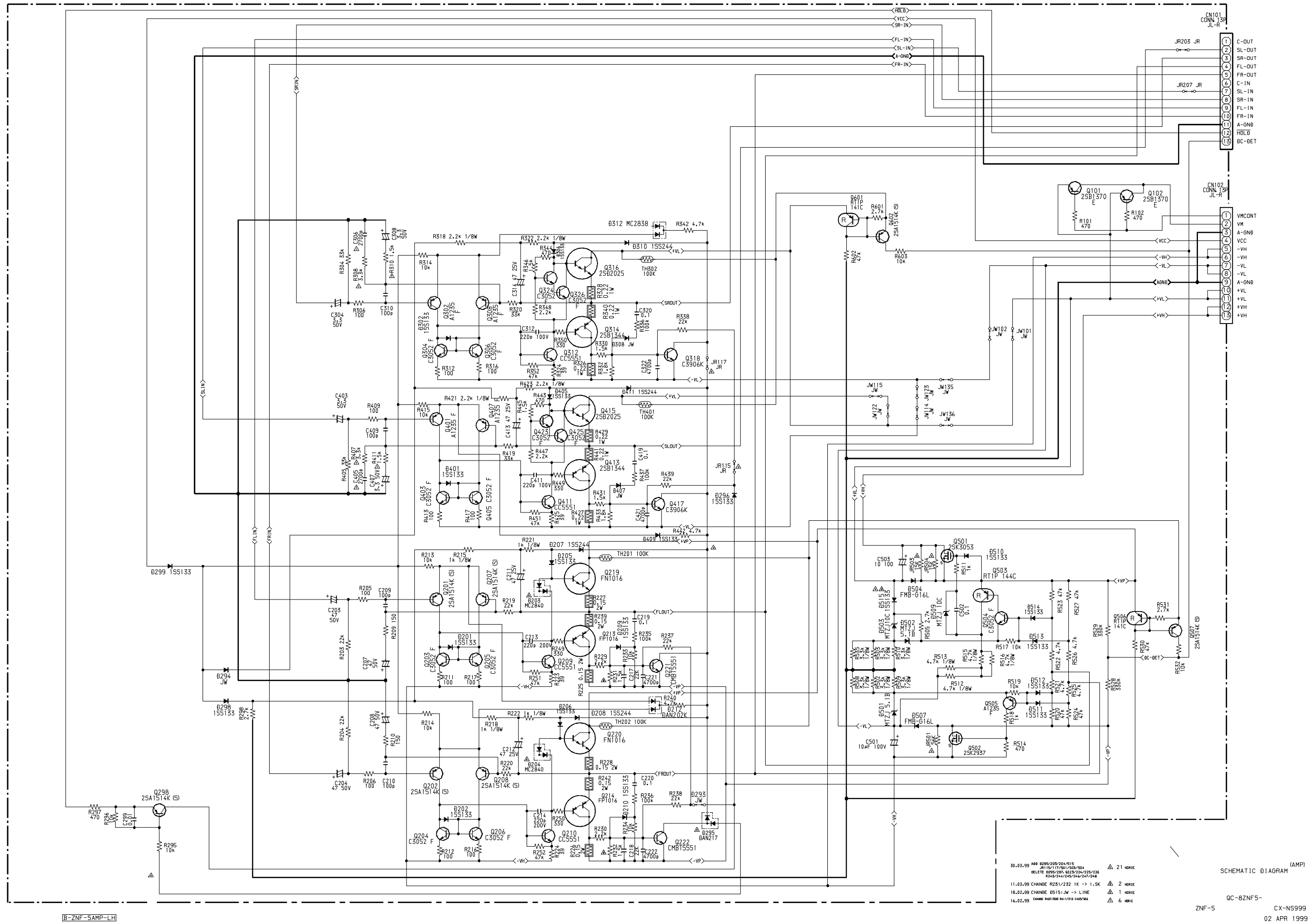

30.03.99 ADD R295/205/204/515  
 18.02.99 CHANGE R251/252 1K -> 1.5K  
 16.02.99 CHANGE R207/R208 10K/10K  
 21 HORI  
 2 HORI  
 1 HORI  
 6 HORI

SCHEMATIC DIAGRAM (AMP)  
 QC-8ZNF5-  
 ZNF-5 CX-NS999  
 02 APR 1999

B-ZNF-5AMP-LH

SCHEMATIC DIAGRAM - 4 (DECK)

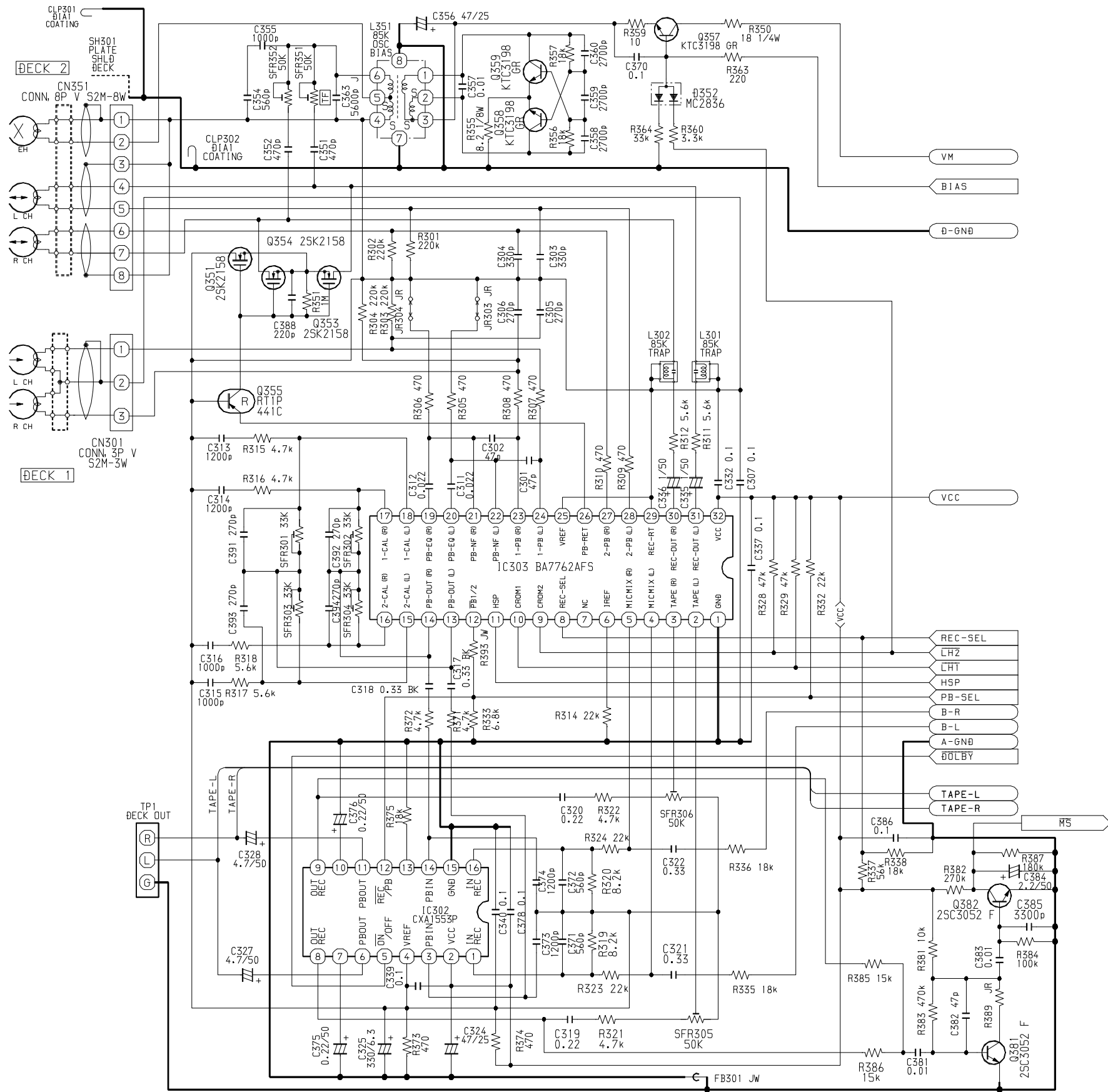

B-ZNF-5MAIN-LH (P2)

(DECK)  
SCHEMATIC DIAGRAM

QC-8ZNF5-

ZNF-5

CX-NS999

15 JAN 1999

# SCHEMATIC DIAGRAM – 5 (TUNER)

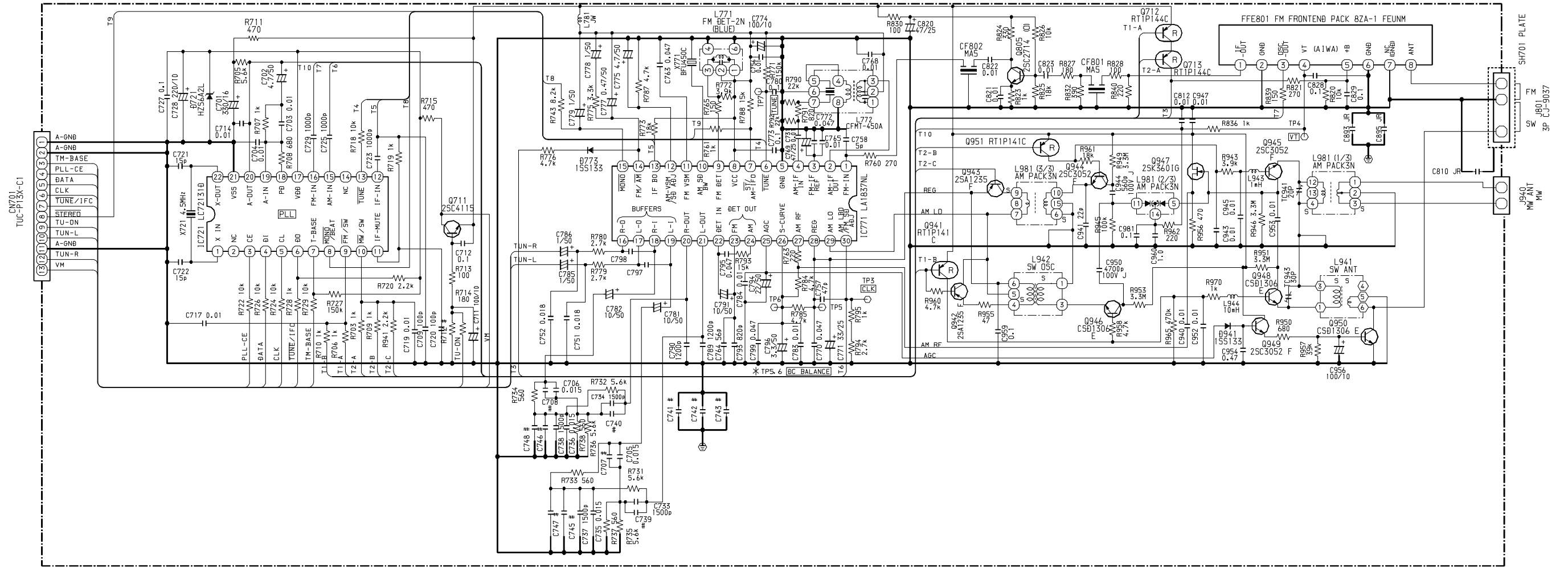

B-ZZA-1-HE5W

SCHEMATIC DIAGRAM - 8 (PT)

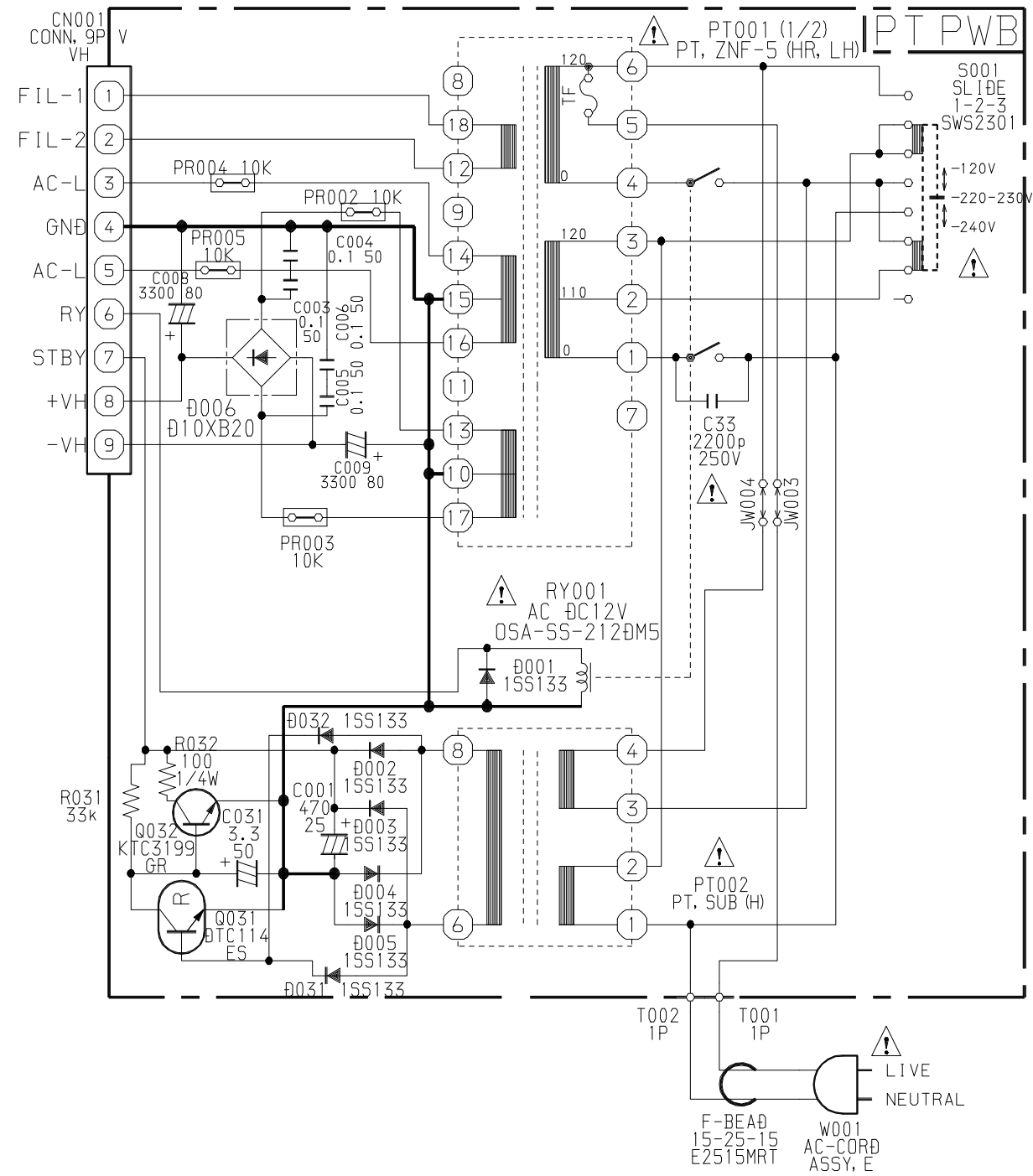

SCHEMATIC DIAGRAM

02.04.99 CHANGE D006 RBA-1002 -> D10XB20 ⚠ 1 HORIE

QC-8ZNH5-

ZNH-5

CX-NK980

B-ZNH-5PT-HR

02 APR 1999

SCHEMATIC DIAGRAM - 7 (K-CON)

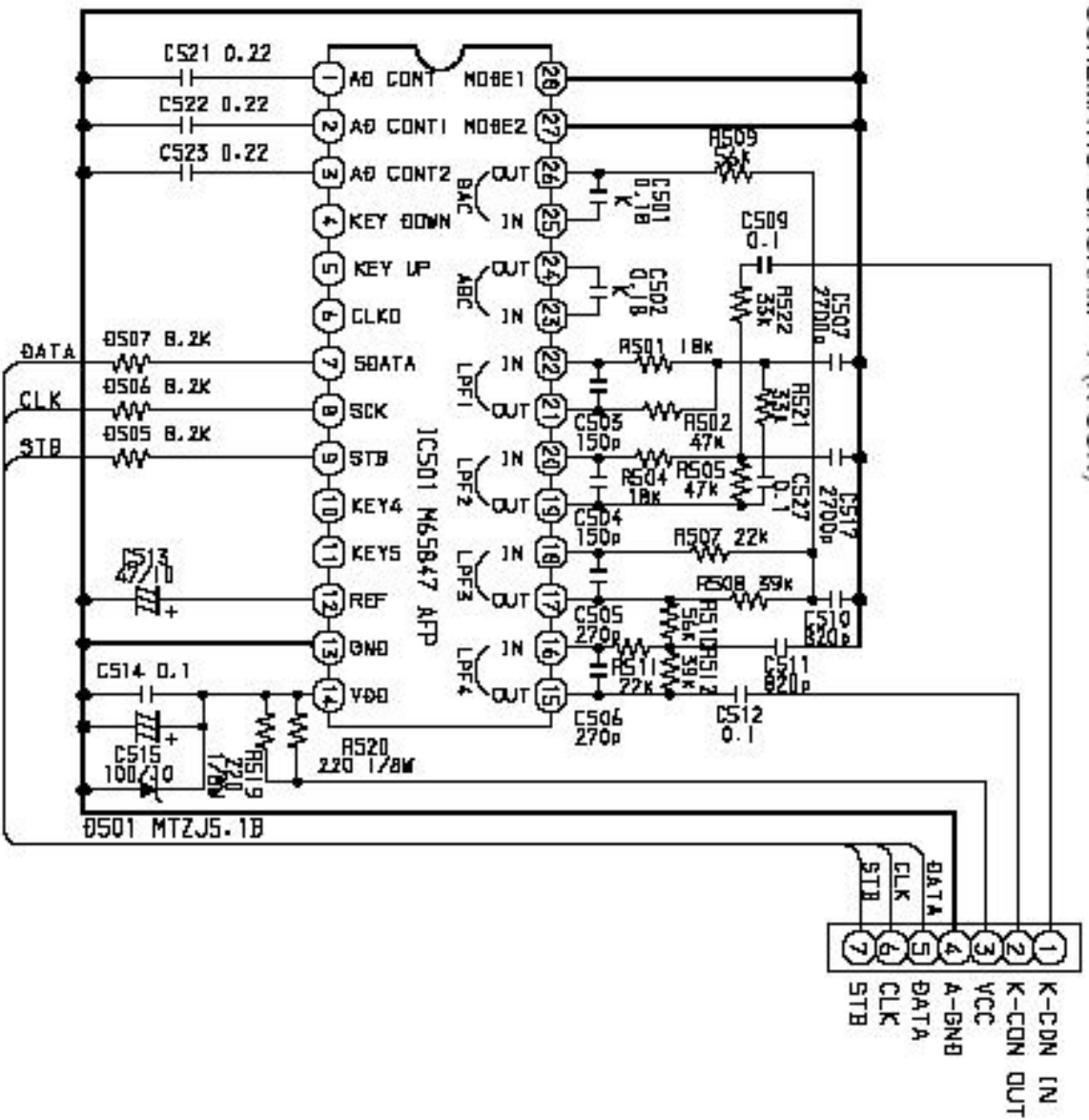

SCHEMATIC DIAGRAM - 6 (GEO)

