

CUC 2103
CUC 2105
CUC 2121
CUC 2121 M
CUC 2121 GB

Geräteliste
siehe Seite 2
List of TV Receivers
see Page 2

Zusätzlich erforderliche Unterlagen für den Komplettservice
Additionally required Service Documents for the Complete Service

**Service
Manual**

CUC 2103/M
CUC 2121/M

Materialnr./Part No.
720100407000

**Service
Manual**

Sicherheit
Safety

Materialnr./Part No.
720108000000

**Service
Training**

CUC 2100

Materialnr./Part No.
© 720103503200
© 720103503300

Grundig Service

Hotline Deutschland...
...Mo.-Fr. 8.00-18.00 Uhr

Technik:

TV	0180/52318-41
TV	0180/52318-49
SAT	0180/52318-48
VCR/LiveCam	0180/52318-42
HiFi/Audio	0180/52318-43
Car Audio	0180/52318-44
Telekommunikation	0180/52318-45
Fax:	0180/52318-51

Planatron (8.00-22.00 Uhr) 0180/52318-99

Ersatzteil-Verkauf: Mo.-Fr. 8.00-19.00 Uhr

Telefon: 0180/52318-40
Fax: 0180/52318-50

Kundendienst/Werkstätten: Mo.-Fr. 8.00-18.00 Uhr

Telefon: 0180/52318-52
Fax: 0180/52318-46

gebührenpflichtig

Materialnummer/Part Number 720100407400

Änderungen vorbehalten/Subject to alteration • Printed in Germany WÜ

H-S46 0302 • 8002/8012, 8003/8013, 8005/8015

<http://www.grundig.com>

CUC 2103

DAVIO 37 P 37-4101 TOP

GCL6100 / VNX
GCL6110 / VNX
GCL6120 / VNX
GCL6130 / VNX

DAVIO 37 P 37-4101 TOP/1

GCL6101 / VNX

DAVIO 37 P 37-4101 MV

GCL6400 / VNX
GCL6410 / VNX
GCL6420 / VNX

CUC 2105

DAVIO 37 P 37-4101/12 MV

GCL3500 / VNA

DAVIO 37 P 37-4101/12 MV/SAT

GCM1800 / VNA

CUC 2121

XENTIA 55 ST 55-405 DOLBY

GCL7100 / VNA
GCL7177 / VNA

DAVIO 55 ST 55-854 DOLBY

GCL3000 / VNA
GCL3072 / VNA

ST 55-908 DOLBY

GCM4200 / VNA

ST 55-998 DOLBY

GCM3100 / VNA

LEEMAXX 55 ST 55-4105 DOLBY

GCM1700 / VNA
GCM1710 / VNA

GREENVILLE SE 5592 DOLBY

GBA2800 / VNM, VNA

LISSABON 562 SE 5595 DOLBY

GCL7575 / VNA

CUC 2121 M

XENTIA 55 ST 55-405/8 DOLBY

GCL7200 / VNX
GCL7277 / VNX

ST 55-839/8 DOLBY

GCM3200 / VNA, VNG, VNR

DAVIO 55 ST 55-854/8 DOLBY

GCL2900 / VNX
GCL2910 / VNX
GCL2920 / VNX
GCL2972 / VNA, VNX

ST 55-908/8 DOLBY

GCL7475 / VNX
GCL7492 / VNX

LEEMAXX 55 ST 55-4105 MV/DOLBY

GCM6600 / VNX
GCM6610 / VNX

GREENVILLE SE 5592 MV/DOLBY

GCN1600 / VNX, VNG

CUC 2121 GB

ST 55-734 GB/DOLBY

GCL7375GB / VNA, VNX

ST 55-934 GB/DOLBY

GCL3175GB / VNA, VNX, VNG

Es gelten die Vorschriften und Sicherheitshinweise gemäß dem Service Manual "Sicherheit", Materialnummer 720108000000, sowie zusätzlich die eventuell abweichenden, landesspezifischen Vorschriften!



The regulations and safety instructions shall be valid as provided by the "Safety" Service Manual, part number 720108000000, as well as the respective national deviations.

Für die auf der Seite 2 aufgeführten Geräte gilt das Service Manual CUC 2103/M, CUC 2121/M.

Diese Ergänzung dokumentiert die Unterschiede bzw. zusätzlichen Bestückungen der Geräte.

Grundlage für den Service sind:

- Service Manual CUC 2103/M, CUC 2121/M (Materialnummer 720100407000)
- Service Manual "Sicherheit" (Materialnummer 720108000000)

The Service Manual CUC 2103/M, CUC 2121/M applies to the sets specified on page 2.

This supplement describes the differences and the additionally fitted components of the sets.

Basic instructions for servicing are given in the:

- Service Manual CUC 2103/M, CUC 2121/M (Part number 720100407000)
- Service Manual "Safety" (Part number 720108000000)

Inhaltsverzeichnis

	Seite
Hinweise	3
Hinweise zu Service- und Sonderfunktionen	4
Modulauflistung – Service Manual mit Ergänzungen	4
Modulübersicht	5
Technische Daten	8
Chassisplatte	12
Oszillogramme (Chassis)	17
Chassisplatte (vergrößert)	19
Teilschaltplan Netzteil	23
Teilschaltplan Ablenkung	25
Teilschaltplan Prozessor	27
Teilschaltplan Tuner	29
Variantenbestückung Video	29
Teilschaltplan Video	31
Teilschaltplan Audio	33
Bildrohrplatte 293051223700 / 3800	35
Baustein Netzteil 12V	37
Prozessor-Platte 293052191600 / 2500 / 2600 / 3000 / 3300 / 3700 / 4100 / 4200	41
Ersatzteillisten	44

Hinweise

Wegen Veränderung des Schwerpunktes beim Abnehmen der Rückwand bzw. Ausbau des Chassis oder Entfernen eines eventuell vorhandenen Standfußes ist das Gerät gegen Kippen zu sichern.

Vor dem Öffnen des Gehäuses zuerst den Netzstecker ziehen!

Leitungsverlegung

Bevor Sie die Leitungen und insbesondere die Masseleitungen lösen, muss die Leitungsverlegung zu den einzelnen Baugruppen wie z.B. Chassis, Netzschalterplatte, Bedieneinheit, Bildrohrplatte, Ablenkeinheit, Lautsprecher usw. beachtet werden.

Nach erfolgter Reparatur ist es notwendig, die Leitungsführung wieder in den werkseitigen Zustand zu versetzen um evtl. spätere Ausfälle oder Störungen zu vermeiden.

Netzkabel

Diese Geräte dürfen nur mit dem Original-Netzanschlusskabel mit integrierter Entstördrossel betrieben werden. Dieses Netzkabel verhindert Störungen aus dem Netz und ist Bestandteil der Gerätezulassung. Im Ersatzfall bestellen Sie bitte ausschließlich das Netzkabel laut Ersatzteilliste.

DOLBY-Hinweis

DOLBY und das Doppel-D-Symbol  sind Warenzeichen der Dolby Laboratories Licensing Corporation.

Table of Contents

	Page
Notes	3
Hints of Service and Special Functions	4
List of Modules – Service Manual with Supplements	4
Module List	5
Technical Data	8
Chassis Board	12
Oscillograms (Chassis)	17
Chassis Board (Enlarged)	19
Circuit Diagram Mains Section	23
Circuit Diagram Deflection Section	25
Circuit Diagram Processor Section	27
Circuit Diagram Tuner	29
Variant Equipment Video	29
Circuit Diagram Video Section	31
Circuit Diagram Audio	33
CRT Panel 293051223700 / 3800	35
Module Mains Unit 12V	37
Processing Board 293052191600 / 2500 / 2600 / 3000 / 3300 / 3700 / 4100 / 4200	41
Spare Parts Lists	44

Notes

Because of the change of the centre of gravity when removing the rear panel, the chassis or an existing stand, it is necessary to protect the set from tipping.

Before opening the cabinet disconnect the mains plug!

Wiring

Before disconnecting any leads and especially the earth connecting leads observe the way they are routed to the individual assemblies like the chassis, mains switch panel, keyboard control panel, picture tube panel, deflection unit, loudspeaker and so on.

On completion of the repairs the leads must be laid out as originally fitted at the factory to avoid later failures or disturbances.

Mains Cable

The TV receiver must only be operated with an original mains connecting cable with an interference suppressor choke integrated in the mains plug. This mains cable prevents interference from the mains supply and is part of the product approval. For replacement please order exclusively the mains connecting cable specified in the spare parts list.

DOLBY Hint

DOLBY and the double-D symbol  are trademarks of Dolby Laboratories Licensing Corporation.

Hinweise zu Service- und Sonderfunktionen

OEM

Mit Taste "i" die Dialogzeile "OEM" über "Dialog Center" -> "Service" -> Service Code "8500" aufrufen.

Farbumstellung der Menüs.

Für GRUNDIG: OEM "off"

Leuchtstärke LED-Betriebsanzeige

Mit Taste "i" die Dialogzeile "End" über "Dialog Center" -> "Service" -> Service Code "8500" aufrufen.

Mit den Fernbedientasten "rot" minus und "grün" plus wird die Leuchtstärke der LED im **Betriebszustand** eingestellt.

Mit den Fernbedientasten "gelb" minus und "blau" plus wird die Leuchtstärke der LED in **Standby** eingestellt.

Mit "OK" bestätigen.

Software-Versionsnummer

Das Menü "Info-CENTER" aufrufen. Durch Betätigen der "AUX" Taste wird die Software-Versionsnummer des TV-Gerätes angezeigt.

Remote Control

Mit Taste "i" die Dialogzeile "Remote cont." über "Dialog Center" -> "Service" -> Service Code "8500" aufrufen.

Einstellung auf "0" für TP750C (30kHz).

Hints of Service and Special Functions

OEM

Call up the dialog line "OEM" with button "i" via "Dialog Center" -> "Service" -> Service Code "8500".

Colour change of the menus.

Setting for GRUNDIG: OEM "off"

Luminosity of the Operating Mode LED

Call up the dialog line "End" with button "i" via "Dialog Center" -> "Service" -> Service Code "8500".

Use the "red" minus and "green" plus buttons on the remote control to adjust the LED luminosity in **normal operating mode**.

Use the "yellow" minus and "blue" plus buttons on the remote control to adjust the LED luminosity in **standby mode**.

Confirm with "OK".

Software Version Number

Call up the "Info centre" menu. Pressing the "AUX" button displays the software version number of the TV set.

Remote Control

Call up the dialog line "Remote cont." with button "i" via "Dialog Center" -> "Service" -> Service Code "8500".

Set to "0" for TP750C (30kHz).

Modulauflistung – Service Manual mit Ergänzungen List of Modules – Service Manual with Supplements

Modul Module	Materialnummer Part Number	Service Manual CUC 2103/M, 2121/M	4. Ergänzung / Supplement 4 CUC 2103, 2105, 2121/M, 2121 GB
		720100407000	720100407400
Chassisplatte Chassis Board		Seite / Page 3 - 1	Seite / Page 12
Prozessor-Modul Processing Board	293052191600	Seite / Page 3 - 27	Seite / Page 41
	293052192500	Seite / Page 3 - 27	Seite / Page 41
	293052192600	Seite / Page 3 - 27	Seite / Page 41
	293052192700	–	Seite / Page 41
	293052193000	–	Seite / Page 41
	293052193300	–	Seite / Page 41
	293052193700	–	Seite / Page 41
	293052194100	–	Seite / Page 41
	293052194200	–	Seite / Page 41
Bildrohrplatte CRT Panel	293051223700	Seite / Page 3 - 25	Seite / Page 35
	293051223800	Seite / Page 3 - 25	Seite / Page 35
NF-Baustein Stereo AF Module Stereo	295041028300	Seite / Page 3 - 30	–
	295041028400	Seite / Page 3 - 30	–
Netzteil 12V Mains Unit 12 V	293050073400	–	Seite / Page 37
SAT-Baustein SAT Module	295041062900	Seite / Page 3 - 33	–

Modulübersicht / Module List

	Materialnummer Part Number	DAVIO 37 P 37-4101 TOP (VNX) CUC 2103	DAVIO 37 P 37-4101 TOP/1 (VNX) CUC 2103	DAVIO 37 P 37-4101 MV (VNX) CUC 2103	DAVIO 37 P 37-4101/12 MV (VNA) CUC 2105	DAVIO 37 P 37-4101/12 MV/SAT (VNA) CUC 2105
Bestell-Nr. Order No.		GCL6100 GCL6110 GCL6120 GCL6130	GCL6101	GCL6400 GCL6410 GCL6420	GCL3500	GCM1800
Chassis-Nr. Chassis No.		297040126500	297040126500	297040126700	297040125900	297040126000
SAT Tuner	295042019200	—	—	—	—	•
PLL Tuner	295043010100	—	—	—	—	—
	295045010100	•	•	•	•	•
Prozessorplatte Processing Board	293052193300	•	•	•	•	—
	293052194100	—	—	—	—	•
Bildrohrplatte CRT Panel	293051223700	•	•	•	•	•
Netzteil 12V Mains Unit 12V	293050073400	—	—	—	•	•
TP 750 C (schwarz / black)	296420621800	•	•	•	•	•
SAT-Nachrüstung SER 2100 SAT Retrofitting SER 2100	GAG3000	—	—	—	•	Eingebaut Fitted

	Materialnummer Part Number	XENTIA 55 ST 55-405 DOLBY (VNA) CUC 2121	DAVIO 55 ST 55-854 DOLBY (VNA) CUC 2121	ST 55-908 DOLBY (VNA) CUC 2121	ST 55-998 DOLBY (VNA) CUC 2121
Bestell-Nr. Order No.		GCL7100 GCL7177	GCL3000 GCL3072	GCM4200	GCM3100
Chassis-Nr. Chassis No.		297040135400 297040135500 297040135600	297040135400 297040135500 297040135600	297040136600 297040136700 297040136800	297040135400
PLL Tuner	295045010100	•	•	•	•
Prozessorplatte Processing Board	293052194100	•	•	•	•
Bildrohrplatte CRT Panel	293051223800	•	•	•	•
Stereo-Baustein Stereo Module	295041028300	•	•	•	•
TP 750 C (schwarz / black)	296420621800	—	•	•	—
TP 750 C (grau / grey)	296420621900	•	—	—	•
SAT-Nachrüstung SER 2100 SAT Retrofitting SER 2100	GAG3000	•	•	•	•

	Materialnummer Part Number	LEEMAXX 55 ST 55-4105 DOLBY (VNA) CUC 2121	GREENVILLE SE 5592 DOLBY (VNM) CUC 2121	GREENVILLE SE 5592 DOLBY (VNA) CUC 2121	LISSABON 562 SE 5595 DOLBY (VNA) CUC 2121	XENTIA 55 ST 55-405/8 DOLBY (VNX) CUC 2121 M
Bestell-Nr. Order No.		GCM1700 GCM1710	GBA2800	GBA2800	GCL7575	GCL7200 GCL7277
Chassis-Nr. Chassis No.		297040135900 297040136000 297040136100	297040130100 297040131000 297040132100	297040135400 297040135500 297040135600	297040135400 297040135500	297040135700
PLL Tuner	295045010100	●	●	●	●	●
Prozessorplatte Processing Board	293052193700	—	●	—	—	—
	293052194100	●	—	●	●	—
	293052194200	—	—	—	—	●
Bildrohrplatte CRT Panel	293051223800	●	●	●	●	●
Stereo-Baustein Stereo Module	295041028300	●	●	●	●	—
	295041028400	—	—	—	—	●
TP 750 C (schwarz / black)	296420621800	●	●	●	●	—
	TP 750 C (grau / grey)	296420621900	—	—	—	●
SAT-Nachrüstung SER 2100 SAT Retrofitting SER 2100	GAG3000	●	●	●	●	—

	Materialnummer Part Number	ST 55-839/8 DOLBY (VNA) CUC 2121 M	ST 55-839/8 DOLBY (VNG) CUC 2121 M	ST 55-839/8 DOLBY (VNR) CUC 2121 M	DAVIO 55 ST 55-854/8 DOLBY (VNA) CUC 2121 M	DAVIO 55 ST 55-854/8 DOLBY (VNX) CUC 2121 M
Bestell-Nr. Order No.		GCM3200	GCM3200	GCM3200	GCL2972	GCL2900 GCL2910 GCL2920 GCL2972
Chassis-Nr. Chassis No.		297040133800 297040133900 297040134600	297040130900	297040137900 297040138000 297040138100	297040133600 297040135000	297040135700 297040135800
PLL Tuner	295043010100	●	●	—	●	—
	295045010100	—	—	●	—	●
Prozessorplatte Processing Board	293052192600	●	●	—	●	—
	293052193000	ww. / or	—	—	ww. / or	—
	293052194200	—	—	●	—	●
Bildrohrplatte CRT Panel	293051223800	●	●	●	●	●
Stereo-Baustein Stereo Module	295041028400	●	●	●	●	●
TP 750 C (schwarz / black)	296420621800	●	●	●	—	—
	TP 750 C (grau / grey)	296420621900	—	—	●	●
SAT-Nachrüstung SER 2100 SAT Retrofitting SER 2100	GAG3000	—	●	●	—	—

	Materialnummer Part Number	ST 55-908/8 DOLBY (VNX) CUC 2121 M	LEEMAXX 55 ST 55-4105 MV/DOLBY (VNX) CUC 2121 M	GREENVILLE SE 5592 MV/DOLBY (VNX) CUC 2121 M	GREENVILLE SE 5592 MV/DOLBY (VNG) CUC 2121 M
Bestell-Nr. Order No.		GCL7475 GCL7492	GCM6600 GCM6610	GCN1600	GCN1600
Chassis-Nr. Chassis No.		297040136300 297040136400 297040136500	297040136200	297040130200 297040132900 297040133000	297040137300 297040137400 297040137500
PLL Tuner	295043010100	—	—	•	—
	295045010100	•	•	—	•
Prozessorplatte Processing Board	293052192600	—	—	•	—
	293052193000	—	—	ww. / or	—
	293052194200	•	•	—	•
Bildrohrplatte CRT Panel	293051223800	•	•	•	•
Stereo-Baustein Stereo Module	295041028400	•	•	•	•
TP 750 C (schwarz / black)	296420621800	•	•	•	•
SAT-Nachrüstung SER 2100 SAT Retrofitting SER 2100	GAG3000	—	—	•	•

	Materialnummer Part Number	ST 55-734 GB/DOLBY (VNA) CUC 2121 GB	ST 55-734 GB/DOLBY (VNX) CUC 2121 GB	ST 55-934 GB/DOLBY (VNA) CUC 2121 GB	ST 55-934 GB/DOLBY (VNX) CUC 2121 GB	ST 55-934 GB/DOLBY (VNG) CUC 2121 GB
Bestell-Nr. Order No.		GCL7375GB	GCL7375GB	GCL3175GB	GCL3175GB	GCL3175GB
Chassis-Nr. Chassis No.		297040133100	297040133700	297040133100	297040135200	297040137200
PLL Tuner	295043010100	•	—	•	•	—
	295043010400	—	•	—	—	—
	295045010100	—	—	—	—	•
Prozessorplatte Processing Board	293052192500	•	—	•	—	—
	293052192700	—	•	ww. / or	—	—
	293052193000	—	—	—	•	—
	293052194200	—	—	—	—	•
Bildrohrplatte CRT Panel	293051223800	•	•	•	•	•
Stereo-Baustein Stereo Module	295041028400	•	•	•	•	•
TP 750 C (schwarz / black)	296420621800	•	•	•	•	•
SAT-Nachrüstung SER 2100 SAT Retrofitting SER 2100	GAG3000	•	—	•	—	—

	DAVIO 37 P 37-4101 TOP (VNX) CUC 2103	DAVIO 37 P 37-4101 TOP/1 (VNX) CUC 2103	DAVIO 37 P 37-4101 MV (VNX) CUC 2103	DAVIO 37 P 37-4101/12 MV (VNA) CUC 2105	DAVIO 37 P 37-4101/12 MV/SAT (VNA) CUC 2105
Bildröhre / Picture Tube					
Sichtbares Bild Visible picture	34cm	34cm	34cm	34cm	34cm
Bildröhre Picture tube	37cm (14") Black Matrix, Philips/90°	37cm (14") Black Matrix, Philips/90°	37cm (14") Black Matrix, Philips/90°	37cm (14") Black Matrix, Philips/90°	37cm (14") Black Matrix, Philips/90°
Elektronik / Electronic					
Programmspeicherplätze Programme positions	99 + 1 AV	99 + 1 AV	99 + 1 AV	99 + 1 AV 199 TV/SAT + 59 Radio + 1 AV (bei Nachrüstung SAT/ when retrofitted with SAT)	199 TV/SAT + 59 Radio + 1 AV
Tuner	PLL Frequenz Synthesizer Tuning UHF/VHF, globale Pinbelegung PLL frequency synthesizer tuning UHF/VHF, global pinning				
TV-Normen TV-Standards	B/G PAL, via AV: NTSC 4.43MHz	B/G PAL, via AV: NTSC 4.43MHz	B/G, I, D/K, K', L/L' PAL, SECAM, NTSC 4.43MHz, via AV: NTSC 3.58MHz	B/G, I, D/K, K', L/L' PAL, SECAM, NTSC 4.43MHz, via AV: NTSC 3.58MHz	B/G, I, D/K, K', L/L' PAL, SECAM, NTSC 4.43MHz, via AV: NTSC 3.58MHz
Stereo-Systeme Stereo systems	—	—	—	—	—
Videotext Teletext	TOP/FLOF Level 1.5, VPS, 8 Seiten TOP/FLOF level 1.5, VPS, 8 pages	TOP/FLOF Level 1.5, VPS, 8 Seiten TOP/FLOF level 1.5, VPS, 8 pages	TOP/FLOF Level 1.5, VPS, 8 Seiten TOP/FLOF level 1.5, VPS, 8 pages	TOP/FLOF Level 1.5, VPS, 8 Seiten TOP/FLOF level 1.5, VPS, 8 pages	TOP/FLOF Level 1.5, VPS, 8 Seiten TOP/FLOF level 1.5, VPS, 8 pages
Musikleistung ohne externe LS Music power without external LS	Mono 6W	Mono 6W	Mono 6W	Mono 6W	Mono 6W
Anschlüsse Front / Connections Front					
Kopfhörer Headphones	Mono 3,5mm Klinkenbuchse, schaltet eingebauten Lautsprecher ab Mono 3.5mm jack, switch off inserted Loudspeaker				
Anschlüsse Rückwand / Connections Rear Panel					
Euro AV 1 (schwarz/black)	FBAS Ein-/Ausgang, RGB Eingang, SBAS Eingang CCVS in-/output, RGB input, SCVS input	FBAS Ein-/Ausgang, RGB Eingang, SBAS Eingang CCVS in-/output, RGB input, SCVS input	FBAS Ein-/Ausgang, RGB Eingang, SBAS Eingang CCVS in-/output, RGB input, SCVS input	FBAS Ein-/Ausgang, RGB Eingang, SBAS Eingang CCVS in-/output, RGB input, SCVS input	FBAS Ein-/Ausgang, RGB Eingang, SBAS Eingang CCVS in-/output, RGB input, SCVS input
SER 2100	—	—	—	nachrüstbar retrofitable	•
Netzteil / Mains Stage					
Netzspannung (Regelbereich) Mains voltage (variable)	230V ±15%	230V ±15%	230V ±15%	230V ±15%	230V ±15%
Netzfrequenz Mains frequency	50 / 60Hz	50 / 60Hz	50 / 60Hz	50 / 60Hz	50 / 60Hz
Leistungsaufnahme Power consumption	ca. 38W	ca. 38W	ca. 38W	ca. 35W	ca. 45W
Standby	ca. 4W	ca. 4W	ca. 4W	ca. 2W	ca. 3W

	XENTIA 55 ST 55-405 DOLBY (VNA) CUC 2121	DAVIO 55 ST 55-854 DOLBY (VNA) CUC 2121	ST 55-908 DOLBY (VNA) CUC 2121	ST 55-998 DOLBY (VNA) CUC 2121	LEEMAXX 55 ST 55-4105 DOLBY (VNA) CUC 2121
Bildröhre / Picture Tube					
Sichtbares Bild Visible picture	51cm	51cm	51cm	51cm	51cm
Bildröhre Picture tube	55cm (21") Black Line D, Philips/90°, alternativ/alternatively Thomson, Samsung/90°	55cm (21") Black Line D, Philips/90°, alternativ/alternatively Thomson, Samsung/90°	55cm (21") Black Line D, Philips/90°, alternativ/alternatively Thomson, Samsung/90°	55cm (21") Black Line D, Philips/90°, alternativ/alternatively Thomson, Samsung/90°	55cm (21") Black Line D, Philips/90°, alternativ/alternatively Thomson, Samsung/90°
Elektronik / Electronic					
Programmspeicherplätze Programme positions	99 + 2 AV 199 TV/SAT + 59 Radio + 2 AV (bei Nachrüstung SAT/ when retrofitted with SAT)	99 + 2 AV 199 TV/SAT + 59 Radio + 2 AV (bei Nachrüstung SAT/ when retrofitted with SAT)	99 + 2 AV 199 TV/SAT + 59 Radio + 2 AV (bei Nachrüstung SAT/ when retrofitted with SAT)	99 + 2 AV 199 TV/SAT + 59 Radio + 2 AV (bei Nachrüstung SAT/ when retrofitted with SAT)	99 + 2 AV 199 TV/SAT + 59 Radio + 2 AV (bei Nachrüstung SAT/ when retrofitted with SAT)
Tuner	PLL Frequenz Synthesizer Tuning UHF/VHF, globale Pinbelegung PLL frequency synthesizer tuning UHF/VHF, global pinning				
TV-Normen TV-Standards	B/G PAL, via AV: NTSC 4.43MHz	B/G PAL, via AV: NTSC 4.43MHz	B/G PAL, via AV: NTSC 4.43MHz	B/G PAL, via AV: NTSC 4.43MHz	B/G PAL, via AV: NTSC 4.43MHz
Stereo-Systeme Stereo systems	Deutsch A2 / German A2	Deutsch A2 / German A2	Deutsch A2 / German A2	Deutsch A2 / German A2	Deutsch A2 / German A2
Videotext Teletext	TOP/FLOF Level 1.5, VPS, 8 Seiten TOP/FLOF level 1.5, VPS, 8 pages	TOP/FLOF Level 1.5, VPS, 8 Seiten TOP/FLOF level 1.5, VPS, 8 pages	TOP/FLOF Level 1.5, VPS, 8 Seiten TOP/FLOF level 1.5, VPS, 8 pages	TOP/FLOF Level 1.5, VPS, 8 Seiten TOP/FLOF level 1.5, VPS, 8 pages	TOP/FLOF Level 1.5, VPS, 8 Seiten TOP/FLOF level 1.5, VPS, 8 pages
Musikleistung ohne externe LS Music power without external LS	Stereo 2x8W (Virtual Dolby)	Stereo 2x8W (Virtual Dolby)	Stereo 2x8W (Virtual Dolby)	Stereo 2x8W (Virtual Dolby)	Stereo 2x8W (Virtual Dolby)
Anschlüsse Front / Connections Front					
Kopfhörer Headphones	Stereo 3,5mm Klinkenbuchse, Lautstärke regelbar, individuelle Tonkanalwahl bei 2-Ton-Empfang Stereo 3.5mm jack, adjustable volume, individual channel selection with dual-sound broadcasts				
Cinch-AV-Buchse Cinch AV socket	1x FBAS Video / in 1x CCVS Video / in 2x Audio / in (AV 2 Position)	1x FBAS Video / in 1x CCVS Video / in 2x Audio / in (AV 2 Position)	1x FBAS Video / in 1x CCVS Video / in 2x Audio / in (AV 2 Position)	1x FBAS Video / in 1x CCVS Video / in 2x Audio / in (AV 2 Position)	1x FBAS Video / in 1x CCVS Video / in 2x Audio / in (AV 2 Position)
Anschlüsse Rückwand / Connections Rear Panel					
Euro AV 1 (schwarz/black)	FBAS Ein-/Ausgang, RGB Eingang, SBAS Eingang CCVS in-/output, RGB input, SCVS input	FBAS Ein-/Ausgang, RGB Eingang, SBAS Eingang CCVS in-/output, RGB input, SCVS input	FBAS Ein-/Ausgang, RGB Eingang, SBAS Eingang CCVS in-/output, RGB input, SCVS input	FBAS Ein-/Ausgang, RGB Eingang, SBAS Eingang CCVS in-/output, RGB input, SCVS input	FBAS Ein-/Ausgang, RGB Eingang, SBAS Eingang CCVS in-/output, RGB input, SCVS input
SER 2100	nachrüstbar retrofitable	nachrüstbar retrofitable	nachrüstbar retrofitable	nachrüstbar retrofitable	nachrüstbar retrofitable
Netzteil / Mains Stage					
Netzspannung (Regelbereich) Mains voltage (variable)	230V ±15%	230V ±15%	230V ±15%	230V ±15%	230V ±15%
Netzfrequenz Mains frequency	50 / 60Hz	50 / 60Hz	50 / 60Hz	50 / 60Hz	50 / 60Hz
Leistungsaufnahme Power consumption	ca. 65W	ca. 65W	ca. 65W	ca. 65W	ca. 70W
Standby	ca. 5W	ca. 5W	ca. 5W	ca. 5W	ca. 5W

	GREENVILLE SE 5592 DOLBY (VNM, VNA) CUC 2121	LISSABON 562 SE 5595 DOLBY (VNA) CUC 2121	XENTIA 55 ST 55-405/8 DOLBY (VNX) CUC 2121 M	ST 55-839/8 DOLBY (VNA, VNG, VNR) CUC 2121 M	DAVIO 55 ST 55-854/8 DOLBY (VNA, VNX) CUC 2121 M
Bildröhre / Picture Tube					
Sichtbares Bild Visible picture	51cm	51cm	51cm	51cm	51cm
Bildröhre Picture tube	55cm (21") Black Line D, Philips/90°, alternativ/alternatively Thomson, Samsung/90°	55cm (21") Black Line D, Philips/90°, alternativ/alternatively Thomson, Samsung/90°	55cm (21") Black Line D, Philips/90°, alternativ/alternatively Thomson, Samsung/90°	55cm (21") Black Line D, Philips/90°, alternativ/alternatively Thomson, Samsung/90°	55cm (21") Black Line D, Philips/90°, alternativ/alternatively Thomson, Samsung/90°
Elektronik / Electronic					
Programmspeicherplätze Programme positions	99 + 2 AV 199 TV/SAT + 59 Radio + 2 AV (bei Nachrüstung SAT/ when retrofitted with SAT)	99 + 2 AV 199 TV/SAT + 59 Radio + 2 AV (bei Nachrüstung SAT/ when retrofitted with SAT)	99 + 2 AV	99 + 2 AV 199 TV/SAT + 59 Radio + 2 AV (bei Nachrüstung SAT/ when retrofitted with SAT)	99 + 2 AV
Tuner	PLL Frequenz Synthesizer Tuning UHF/VHF, globale Pinbelegung PLL frequency synthesizer tuning UHF/VHF, global pinning				
TV-Normen TV-Standards	B/G PAL, via AV: NTSC 4.43MHz	B/G PAL, via AV: NTSC 4.43MHz	B/G, I, D/K, K', L/L' PAL, SECAM, NTSC 4.43MHz, via AV: NTSC 3.58MHz	B/G, I, D/K, K', L/L' PAL, SECAM, NTSC 4.43MHz, via AV: NTSC 3.58MHz	B/G, I, D/K, K', L/L' PAL, SECAM, NTSC 4.43MHz, via AV: NTSC 3.58MHz
Stereo-Systeme Stereo systems	Deutsch A2 / German A2	Deutsch A2 / German A2	Deutsch A2 / German A2 (B/G/D/K) Nicam 5.85 (B/G, L) + 6.52MHz (I)	Deutsch A2 / German A2 (B/G/D/K) Nicam 5.85 (B/G, L) + 6.52MHz (I)	Deutsch A2 / German A2 (B/G/D/K) Nicam 5.85 (B/G, L) + 6.52MHz (I)
Videotext Teletext	TOP/FLOF Level 1.5, VPS, 8 Seiten TOP/FLOF level 1.5, VPS, 8 pages	TOP/FLOF Level 1.5, VPS, 8 Seiten TOP/FLOF level 1.5, VPS, 8 pages	TOP/FLOF Level 1.5, VPS, 8 Seiten TOP/FLOF level 1.5, VPS, 8 pages	TOP/FLOF Level 1.5, VPS, 8 Seiten TOP/FLOF level 1.5, VPS, 8 pages	TOP/FLOF Level 1.5, VPS, 8 Seiten TOP/FLOF level 1.5, VPS, 8 pages
Musikleistung ohne externe LS Music power without external LS	Stereo 2x8W (Virtual Dolby)	Stereo 2x8W (Virtual Dolby)	Stereo 2x8W (Virtual Dolby)	Stereo 2x8W (Virtual Dolby)	Stereo 2x8W (Virtual Dolby)
Anschlüsse Front / Connections Front					
Kopfhörer Headphones	Stereo 3,5mm Klinkenbuchse, Lautstärke regelbar, individuelle Tonkanalwahl bei 2-Ton-Empfang Stereo 3.5mm jack, adjustable volume, individual channel selection with dual-sound broadcasts				
Cinch-AV-Buchse Cinch AV socket	1x FBAS Video / in 1x CCVS Video / in 2x Audio / in (AV 2 Position)	1x FBAS Video / in 1x CCVS Video / in 2x Audio / in (AV 2 Position)	1x FBAS Video / in 1x CCVS Video / in 2x Audio / in (AV 2 Position)	1x FBAS Video / in 1x CCVS Video / in 2x Audio / in (AV 2 Position)	1x FBAS Video / in 1x CCVS Video / in 2x Audio / in (AV 2 Position)
Anschlüsse Rückwand / Connections Rear Panel					
Euro AV 1 (schwarz/black)	FBAS Ein-/Ausgang, RGB Eingang, SBAS Eingang CCVS in-/output, RGB input, SCVS input	FBAS Ein-/Ausgang, RGB Eingang, SBAS Eingang CCVS in-/output, RGB input, SCVS input	FBAS Ein-/Ausgang, RGB Eingang, SBAS Eingang CCVS in-/output, RGB input, SCVS input	FBAS Ein-/Ausgang, RGB Eingang, SBAS Eingang CCVS in-/output, RGB input, SCVS input	FBAS Ein-/Ausgang, RGB Eingang, SBAS Eingang CCVS in-/output, RGB input, SCVS input
SER 2100	nachrüstbar retrofitable	nachrüstbar retrofitable	—	nachrüstbar (nur VNG, VNR) retrofitable (only VNG, VNR)	—
Netzteil / Mains Stage					
Netzspannung (Regelbereich) Mains voltage (variable)	230V ±15%	230V ±15%	230V ±15%	230V ±15%	230V ±15%
Netzfrequenz Mains frequency	50 / 60Hz	50 / 60Hz	50 / 60Hz	50 / 60Hz	50 / 60Hz
Leistungsaufnahme Power consumption	ca. 65W	ca. 65W	ca. 65W	ca. 65W	ca. 65W
Standby	ca. 4W	ca. 5W	ca. 5W	ca. 5W	ca. 5W

	ST 55-908/8 DOLBY (VNX) CUC 2121 M	LEEMAXX 55 ST 55-4105 MV/DOLBY (VNX) CUC 2121 M	GREENVILLE SE 5592 MV/DOLBY (VNX, VNG) CUC 2121 M	ST 55-734 GB/DOLBY (VNA, VNX) CUC 2121 GB	ST 55-934 GB/DOLBY (VNA, VNX, VNG) CUC 2121 GB
Bildröhre / Picture Tube					
Sichtbares Bild Visible picture	51cm	51cm	51cm	51cm	51cm
Bildröhre Picture tube	55cm (21") Black Line D, Philips/90°, alternativ/alternatively Thomson, Samsung/90°	55cm (21") Black Line D, Philips/90°, alternativ/alternatively Thomson, Samsung/90°	55cm (21") Black Line D, Philips/90°, alternativ/alternatively Thomson, Samsung/90°	55cm (21") Black Line D, Philips/90°, alternativ/alternatively Thomson, Samsung/90°	55cm (21") Black Line D, Philips/90°, alternativ/alternatively Thomson, Samsung/90°
Elektronik / Electronic					
Programmspeicherplätze Programme positions	99 + 2 AV	99 + 2 AV	99 + 2 AV 199 TV/SAT + 59 Radio + 2 AV (bei Nachrüstung SAT/ when retrofitted with SAT)	99 + 2 AV 199 TV/SAT + 59 Radio + 2 AV (bei Nachrüstung SAT/ when retrofitted with SAT)	99 + 2 AV 199 TV/SAT + 59 Radio + 2 AV (bei Nachrüstung SAT/ when retrofitted with SAT)
Tuner	PLL Frequenz Synthesizer Tuning UHF/VHF, globale Pinbelegung PLL frequency synthesizer tuning UHF/VHF, global pinning				
TV-Normen TV-Standards	B/G, I, D/K, K', L/L' PAL, SECAM, NTSC 4.43MHz, via AV: NTSC 3.58MHz	B/G, I, D/K, K', L/L' PAL, SECAM, NTSC 4.43MHz, via AV: NTSC 3.58MHz	B/G, I, D/K, K', L/L' PAL, SECAM, NTSC 4.43MHz, via AV: NTSC 3.58MHz	I PAL, SECAM, NTSC 4.43MHz, via AV: NTSC 3.58MHz	I PAL, SECAM, NTSC 4.43MHz, via AV: NTSC 3.58MHz
Stereo-Systeme Stereo systems	Deutsch A2 / German A2 (B/G/D/K) Nicom 5.85 (B/G, L) + 6.52MHz (I)	Deutsch A2 / German A2 (B/G/D/K) Nicom 5.85 (B/G, L) + 6.52MHz (I)	Deutsch A2 / German A2 (B/G/D/K) Nicom 5.85 (B/G, L) + 6.52MHz (I)	Deutsch A2 / German A2 (B/G/D/K) Nicom 5.85 (B/G, L) + 6.52MHz (I)	Deutsch A2 / German A2 (B/G/D/K) Nicom 5.85 (B/G, L) + 6.52MHz (I)
Videotext Teletext	TOP/FLOF Level 1.5, VPS, 8 Seiten TOP/FLOF level 1.5, VPS, 8 pages	TOP/FLOF Level 1.5, VPS, 8 Seiten TOP/FLOF level 1.5, VPS, 8 pages	TOP/FLOF Level 1.5, VPS, 8 Seiten TOP/FLOF level 1.5, VPS, 8 pages	TOP/FLOF Level 1.5, VPS, 8 Seiten TOP/FLOF level 1.5, VPS, 8 pages	TOP/FLOF Level 1.5, VPS, 8 Seiten TOP/FLOF level 1.5, VPS, 8 pages
Musikleistung ohne externe LS Music power without external LS	Stereo 2x8W (Virtual Dolby)	Stereo 2x8W (Virtual Dolby)	Stereo 2x8W (Virtual Dolby)	Stereo 2x8W (Virtual Dolby)	Stereo 2x8W (Virtual Dolby)
Anschlüsse Front / Connections Front					
Kopfhörer Headphones	Stereo 3,5mm Klinkebuchse, Lautstärke regelbar, individuelle Tonkanalwahl bei 2-Ton-Empfang Stereo 3.5mm jack, adjustable volume, individual channel selection with dual-sound broadcasts				
Cinch-AV-Buchse Cinch AV socket	1x FBAS Video / in 1x CCVS Video / in 2x Audio / in (AV 2 Position)	1x FBAS Video / in 1x CCVS Video / in 2x Audio / in (AV 2 Position)	1x FBAS Video / in 1x CCVS Video / in 2x Audio / in (AV 2 Position)	1x FBAS Video / in 1x CCVS Video / in 2x Audio / in (AV 2 Position)	1x FBAS Video / in 1x CCVS Video / in 2x Audio / in (AV 2 Position)
Anschlüsse Rückwand / Connections Rear Panel					
Euro AV 1 (schwarz/black)	FBAS Ein-/Ausgang, RGB Eingang, SBAS Eingang CCVS in-/output, RGB input, SCVS input	FBAS Ein-/Ausgang, RGB Eingang, SBAS Eingang CCVS in-/output, RGB input, SCVS input	FBAS Ein-/Ausgang, RGB Eingang, SBAS Eingang CCVS in-/output, RGB input, SCVS input	FBAS Ein-/Ausgang, RGB Eingang, SBAS Eingang CCVS in-/output, RGB input, SCVS input	FBAS Ein-/Ausgang, RGB Eingang, SBAS Eingang CCVS in-/output, RGB input, SCVS input
SER 2100	—	—	nachrüstbar retrofitable	nachrüstbar (nur VNA) retrofitable (only VNA)	nachrüstbar (nur VNA) retrofitable (only VNA)
Netzteil / Mains Stage					
Netzspannung (Regelbereich) Mains voltage (variable)	230V ±15%	230V ±15%	230V ±15%	230V ±15%	230V ±15%
Netzfrequenz Mains frequency	50 / 60Hz	50 / 60Hz	50 / 60Hz	50 / 60Hz	50 / 60Hz
Leistungsaufnahme Power consumption	ca. 65W	ca. 70W	ca. 65W	ca. 65W	ca. 65W
Standby	ca. 5W	ca. 5W	ca. 4W	ca. 4W	ca. 4W

Platinenabbildungen und Schaltpläne / Layout of PCBs and Circuit Diagrams

Koordinaten für die Bauteile der Bestückungsseite (Oberseite)
Coordinates of the Components on the Components Side (Top Side)

Pos.-Nr./ Pos. No.	Koordinaten/ Coordinates		Pos.-Nr./ Pos. No.	Koordinaten/ Coordinates		Pos.-Nr./ Pos. No.	Koordinaten/ Coordinates		Pos.-Nr./ Pos. No.	Koordinaten/ Coordinates		Pos.-Nr./ Pos. No.	Koordinaten/ Coordinates					
	X	Y		X	Y		X	Y		X	Y		X	Y	X	Y		
BR100	32	99	BR205	47	120	C31042	41	29	C84501	272	174	L81061	225	109	R60502	142	195	
BR101	67	10	BR206	44	119	C31044	47	29				L81062	219	100	R60504	163	174	
BR102	67	15	BR207	41	120	C31046	22	58	D34081	113	121				R60505	170	229	
BR103	67	18	BR209	32	122	C34017	125	64	D34082	113	119	L81064	213	72	R60506	170	216	
BR104	58	20	BR210	35	201	C34021	82	63	D34083	91	114				R60508	142	208	
BR106	140	11							D34084	94	113	NETZ01	230	240	R60509	142	199	
			BR212	45	138	C34026	99	93	D40584	116	22	NETZ02	230	232	R60512	176	238	
BR107	29	131	BR213	30	114	C34037	123	56				OK60531	171	159	R60513	177	241	
BR108	20	131	BR214	34	104	C34039	125	71	D40585	173	16				R60516	186	197	
BR110	99	135	BR215	97	58	C34044	74	63	D40586	126	25				R60531	167	174	
BR112	96	128	BR216	94	161	C34049	75	53	D43055	29	102	P+	264	106	R61018	87	234	
BR113	59	84				C34061	75	53	D43056	29	106	P-	278	106	R61043	120	156	
			BR217	115	175	C34063	56	66	D50023	59	143	P+	264	121	R61046	118	148	
BR114	30	109	BR218	221	85	C34064	58	71				P-	278	121	R61053	177	241	
BR115	34	96	BR219	87	221	C34088	81	108	D50048	96	143				R61056	130	145	
BR116	228	76	BR220	260	185	C40557	145	37	D50201	70	184	PFC01	214	180	R61506	225	126	
BR117	162	115	BR222	56	115	C40586	167	10	D53003	44	183	PFC02	193	180	R61507	95	188	
BR118	195	102							D54001	88	186				R61508	202	140	
			BR225	78	153	C40587	131	28	D54011	98	204	Q34043	91	100	R62501	200	192	
BR119	67	13	BR262	142	26	C43012	37	80				Q34044	88	91	R62502	202	175	
BR120	185	101	BR268	144	29	C43117	79	36	D54022	56	19	Q34046	85	100	R62503	229	176	
BR123	190	49	BR269	211	168	C43118	85	57	EURO-AV01	6	93	Q80001	171	67	R62549	120	208	
BR124	192	103	BR603	173	173	C43119	80	36	D60022	180	174	R31047	25	64	R81025	229	97	
BR125	190	104				C44022	241	58	D60024	183	183	R31048	16	30	R81026	190	66	
			BR604	170	176	C44032	241	51				R32132	42	88	R81028	188	66	
BR126	182	20	BR605	135	211	C46001	210	66	D60026	183	165	R32470	119	37	R81030	175	114	
BR127	129	47	BR31045	30	30	C50013	10	139	D60027	188	171	R34036	143	79	R81033	188	100	
BR128	99	109	BR32025	53	18	C50026	48	159	D60506	159	217				R81037	183	101	
BR129	125	112							D60509	142	208	R34037	134	68	R81039	141	112	
BR130	107	104	BR40554	134	48	C50036	37	123	D60512	180	228	R34050	129	96	R81042	142	76	
			BR40561	132	86	C50037	23	123				R34051	110	110	R81045	161	80	
BR131	156	77	BR40570	143	16	C50041	51	159	D60523	183	174	R34052	112	113	R81054	198	101	
BR132	158	71	BR40571	186	32	C50044	36	144	D61016	98	242	R34053	111	115	R81055	201	110	
BR134	153	68	BR41011	229	40	C50047	64	135	D61036	109	205				R81060	206	110	
BR136	157	25							D61037	108	205	R34054	110	107	R81080	195	66	
BR137	175	50	BR41012	230	45	C50048	86	138	D61056	109	171	R34055	131	99	R81081	193	66	
			BR41013	228	26	C50051	15	135				R34056	36	94	R81082	177	100	
BR138	22	62	BR41016	228	36	C50052	13	123	D61503	188	147	R34083	91	129	R81083	201	110	
BR139	209	9	BR41501	209	17	C50053	24	134	D81501	194	248	R34084	94	129	R81084	177	100	
BR140	222	69	BR41502	195	20	C50061	42	145	D85507	278	184				R81090	203	109	
BR141	131	73							D85511	272	194	R34090	74	102	R81226	238	112	
BR143	145	103	BR43105	81	22	C50062	54	159	D85512	274	194	R34095	70	100	S62501	234	219	
			BR44001	240	82	C50251	68	64				R40571	167	24	S62501	234	219	
BR144	144	105	BR44002	241	85	C52002	73	178	F32109	55	54	R40588	119	19	ST-A01	90	14	
BR145	143	108	BR44003	154	131	C52003	71	204	F32121	37	73	R41007	201	23	ST-A02	30	14	
BR146	140	110	BR44022	224	20	C52004	70	211	F32410	97	42	R41012	228	33	ST-BAT01	160	37	
BR147	156	112							F32412	106	59	R41013	228	29	ST-BAT03	176	33	
BR148	180	102	BR44032	226	23	C52247	113	95	F32430	110	59				ST-BAT2-4	87	193	
			BR52052	55	195	C52251	115	90				R43001	86	29	ST-BR	93	179	
BR151	147	55	BR53011	21	196	C52253	125	88	F34052	90	64	R43003	47	58	ST-COM02	178	24	
BR152	147	58	BR53016	75	247	C52257	125	79				R43006	67	54	ST-COM01	142	136	
BR153	141	66	BR53021	49	171	C53001	30	179	IC34015	93	79	R43011	31	75	ST-H	214	31	
BR154	143	71							IC40550	142	19	R43014	19	21	ST-HOSP02	94	28	
BR157	159	129	BR53073	10	148	C53002	38	195	IC40560	142	21				ST-HOSP01	196	35	
			BR53074	33	166	C53006	33	187	IC60104	108	148	R43019	26	26	ST-IR-KB	264	179	
BR158	193	126	BR60014	160	198	C53011	10	205	IC61050	141	148	R43037	32	91	ST-IR-KB	264	179	
BR160	133	120	BR60506	158	235	C53017	69	246	IC61060	173	148	R43058	32	85	ST-JOCH	56	180	
BR161	241	115	BR60516	183	197	C53031	62	209	IC61510	219	142	R43112	34	21	ST-LS	191	14	
BR162	123	112							IC80500	149	97	R43113	84	32	ST-LS-L	203	14	
BR163	125	134	BR61014	107	242	C53032	69	216	IC81500	188	83				ST-LS-R	180	14	
			BR61015	107	243	C53054	60	159	IC81710	165	50	R43268	27	88	ST-M-L	262	196	
BR164	216	84	BR61016	103	252	C54001	94	169	IC84501	277	173	R44013	68	28	ST-M-LED	204	54	
BR165	19	53	BR61037	107	228	C54011	96	214	IC84502	282	173	R44022	247	55	ST-NETZ01	236	237	
BR166	153	37	BR61040	109	160	C54012	36	134				R46003	207	59	ST-RGB	72	113	
BR167	10	55																
BR168	171	19	BR61041	104	129	C57016	51	103	L+	264	139	R50032	59	184	ST-IR-KB	264	179	
			BR61050	156	135	C60501	140	203	L+	278	139	R50033	55	131	ST-JOCH	56	180	
BR170	236	93	BR61055	102	224	C60504	163	187	L-	264	154	R50035	63	176	ST-LS	191	14	
BR171	220	94	BR62500	204	180	C60507	156	199	L-	278	154	R50047	48	140	ST-LS-L	203	14	
BR172	108	16	BR62501	215	237	C60509	175	228										
BR173	238	117										R50048	86	146	ST-V02	173	125	
BR174	238	122	BR62502	228	211	C60511	178	214	KBL01	142	23	R50061	43	159	ST-V03	144	125	
			BR62503	230	226	C60512	184	233				R52001	71	129	ST-V04	70	34	
BR175	239	127	BR62504	237	188	C60513	165	191	KH01	269	36	R52002	8	169	ST-E	214	190	
BR176	177	127	BR62505	224	188	C60523	189	184	KH02	273	85	R52004	75	198				
BR177	254	174	BR62506	202	175	C60524	176	182				R52006	55	195				
BR178	239	120										R52262	89	120	T52001	67	204	
BR179	176	139	BR80501	163	99	C61052	166	134	L31043	29	30	R52264	74	130	T53001	9	189	
			BR80502	211	111	C61056	105	167	L32023	63	58				T60506	172	212	
BR180	23	74	BR81039	127	42	C61057	122	166	L32026	50	18	R52269	96	109	T81501	241	135	
BR181	71	44	BR81050	187	47	C61063	109	203	L32109	55	60	R53002	47	186	TR52001	65	192	
BR182	71	41	BR81051	178	58	C61067	117	184	L40512	105	27	R53009	19	171	TR53000	37	227	
BR183	70	38				C61071	118	136	L41011	262	93	R53011						

Chassisplatte Chassis Board

Bestückungsseite, Ansicht von oben
Component Side, Top View

	+A
37cm PHI	105V
37cm PHI o.TXT	105V
37cm PHI/OEM	132V
55cm PHI	132V
55cm THO	132V
55cm SAM	132V

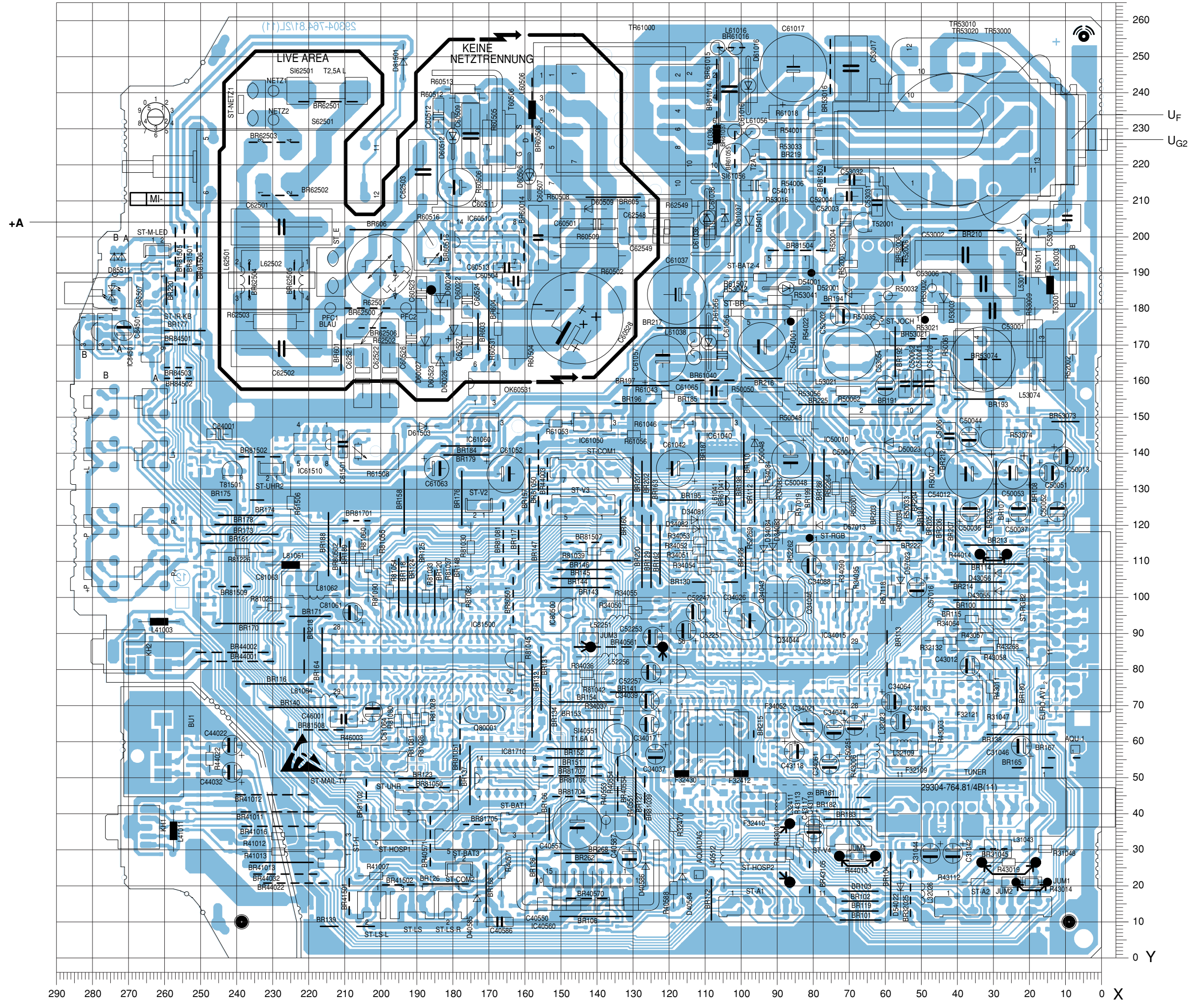

Chassisplatte Chassis Board

Lötseite, Ansicht von unten
Solder Side, Bottom View

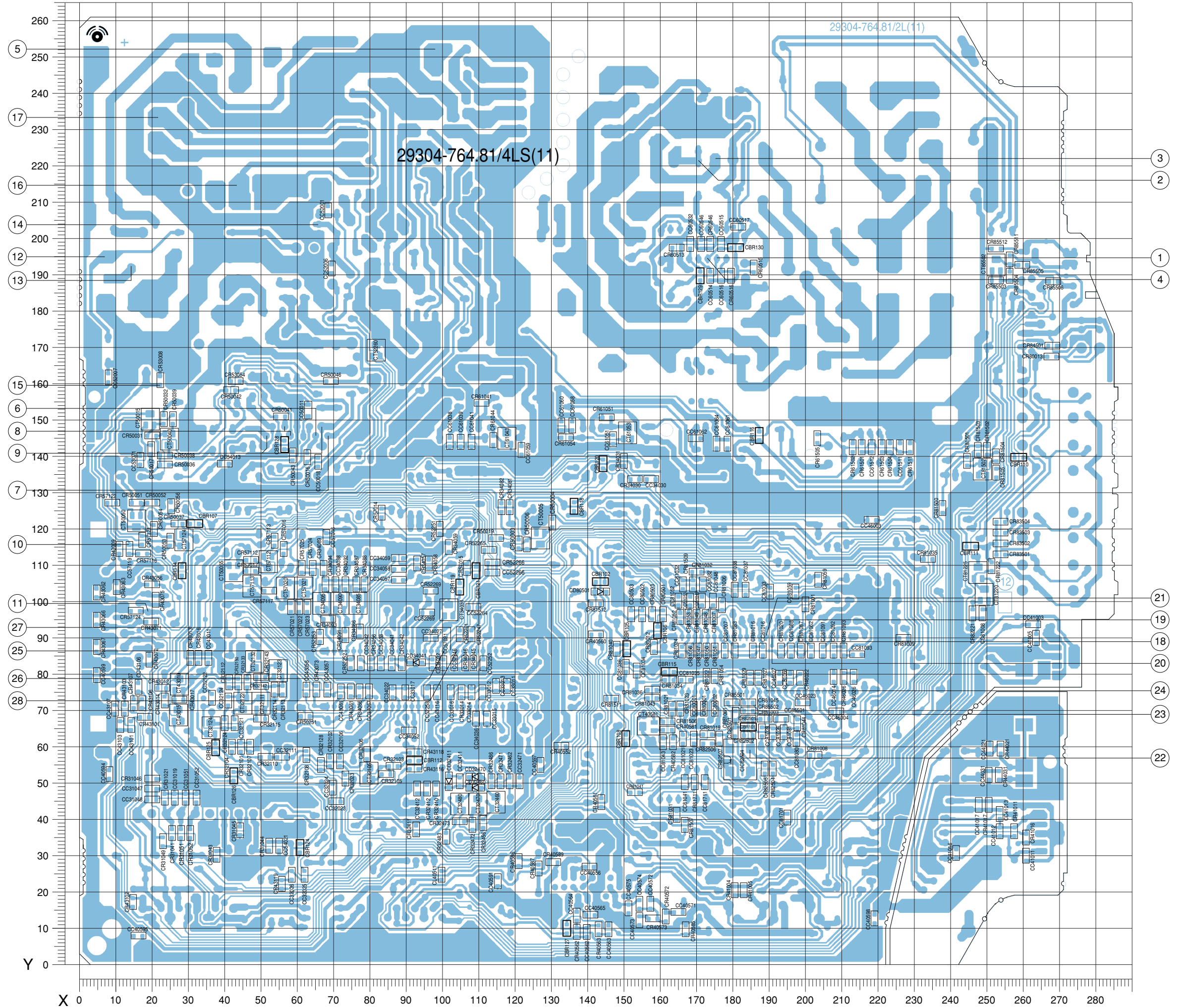

Koordinaten für die Bauteile der Lötseite (Unterseite) / Coordinates of the components on the Solder Side (Bottom Side)

Table with 8 columns of component data (Pos.-Nr./Pos. No., Koordinaten/Coordinates X, Y) for various parts like CBR, CC, CR, CD, CL, and CT.

Oszillogramme Chassis / Oscillograms Chassis

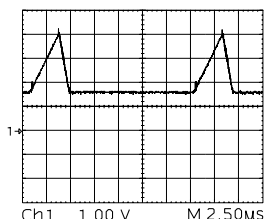

1

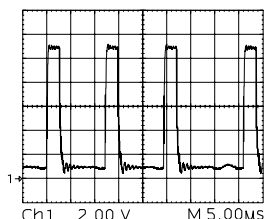

2

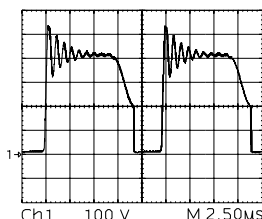

3

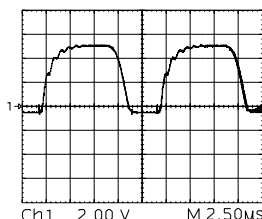

4

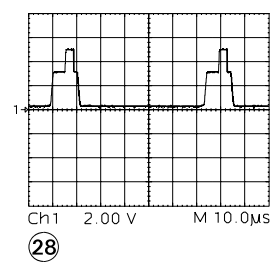
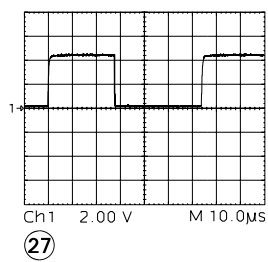
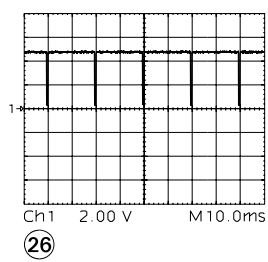
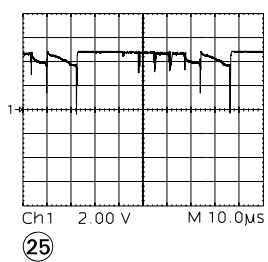
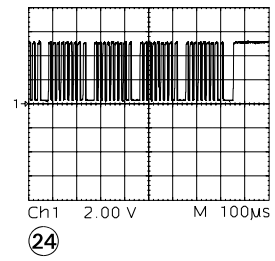
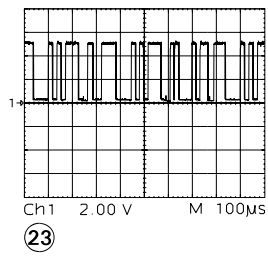
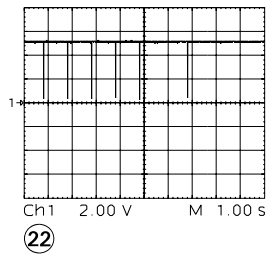
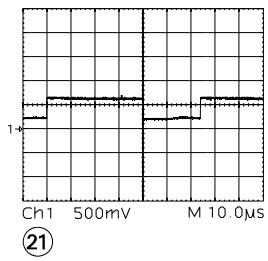
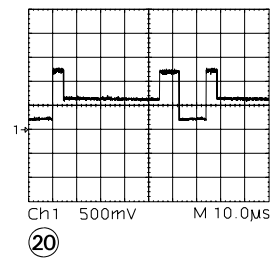
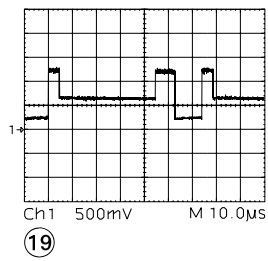
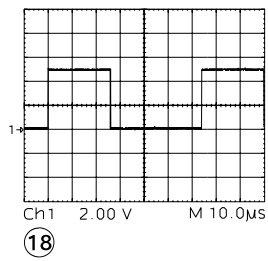
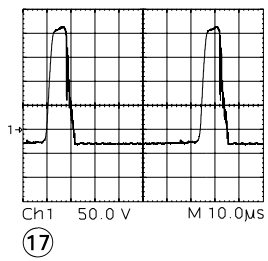
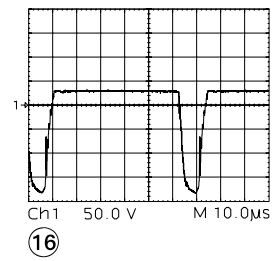
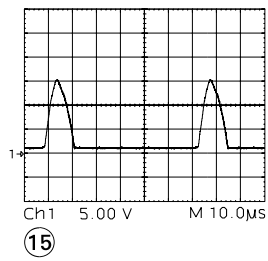
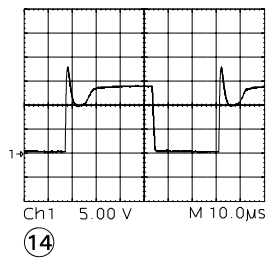
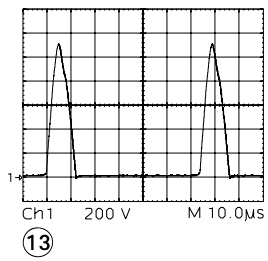
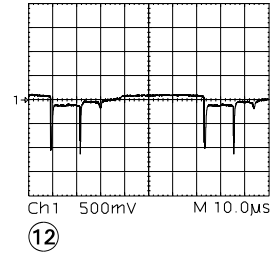
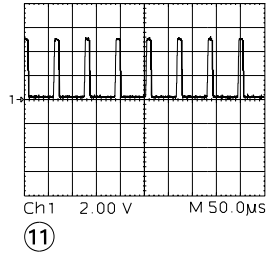
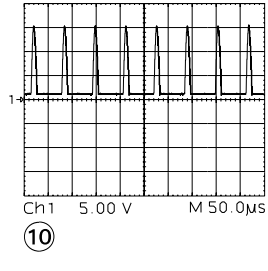
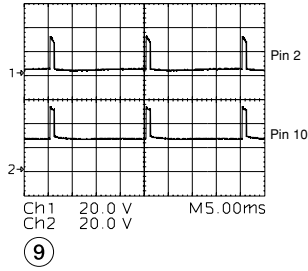
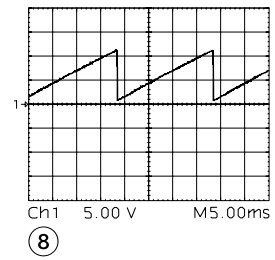
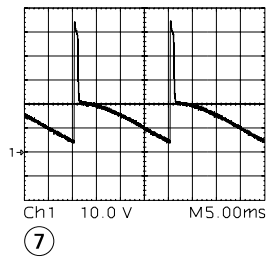
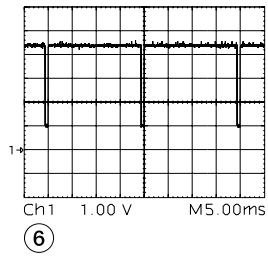
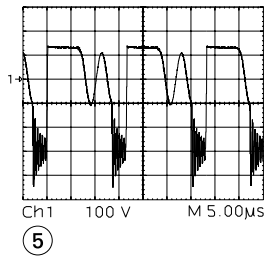

Chassisplatte (vergrößert) Teil 1
Chassis Board (enlarged) Part 1

Lötseite, Ansicht von unten
Solder Side, Bottom View

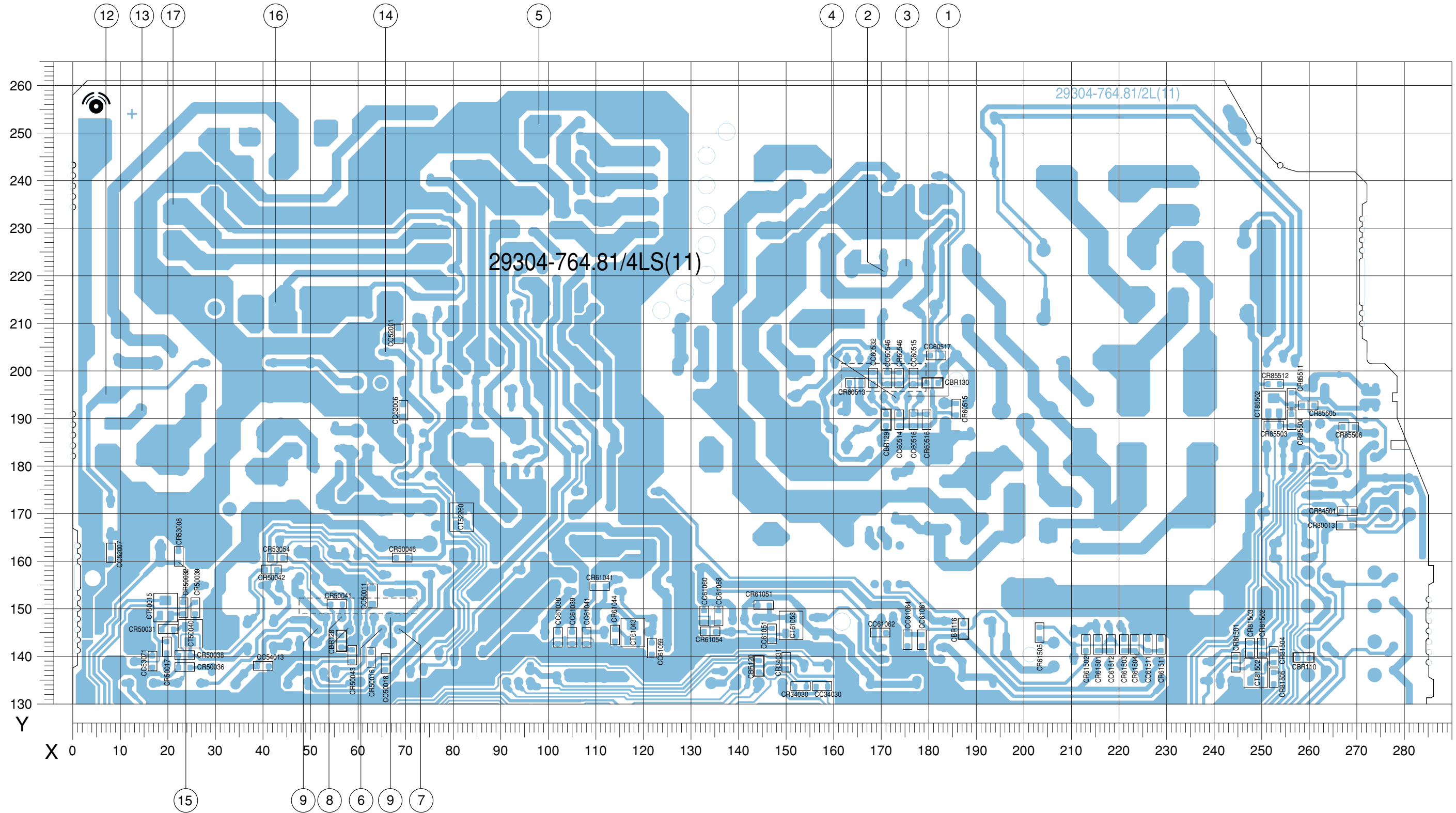

Chassisplatte (vergrößert) Teil 2 Chassis Board (enlarged) Part 2

Lötseite, Ansicht von unten
Solder Side, Bottom View

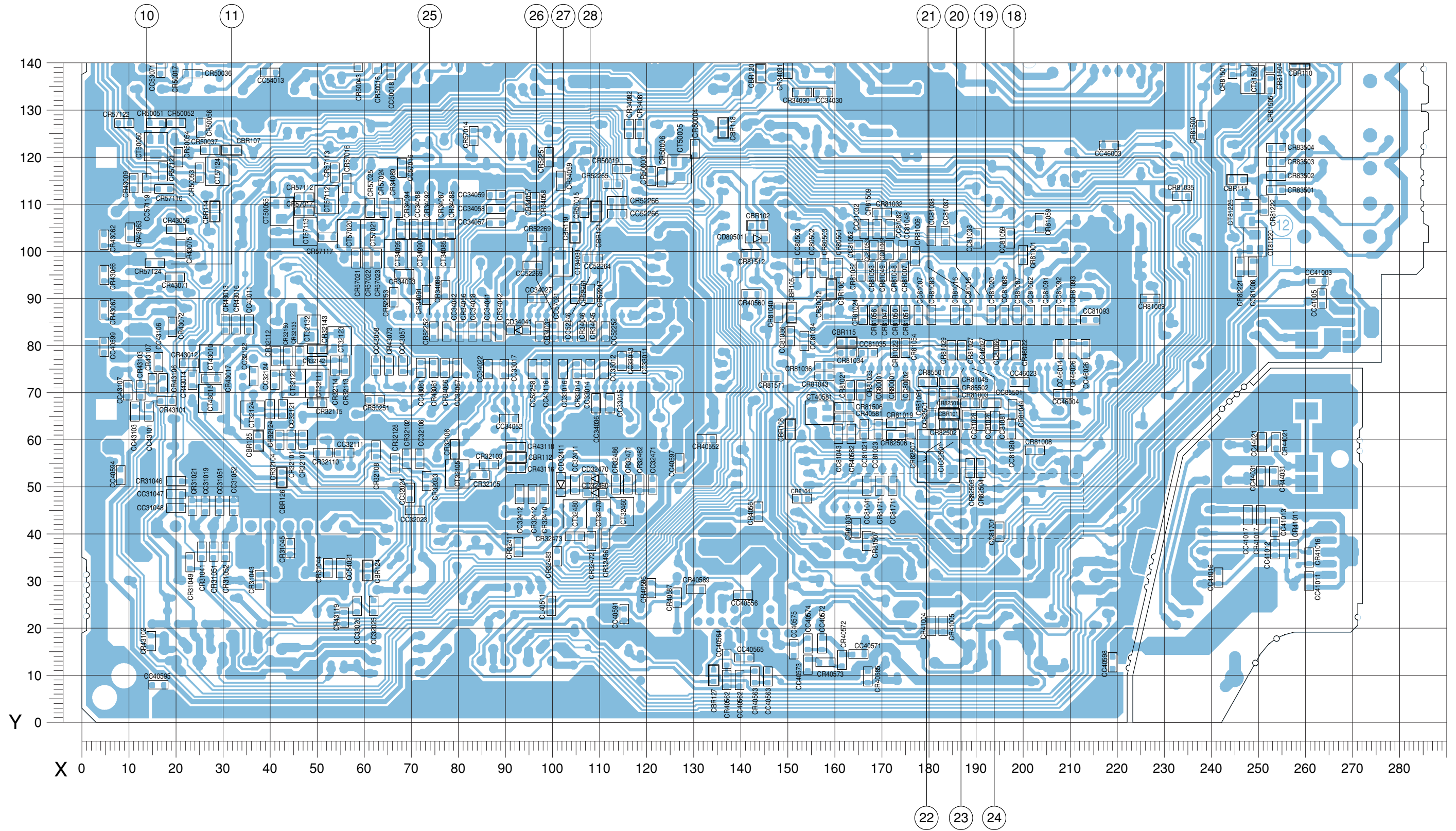

Teilschaltplan Netzteil / Circuit Diagram Mains Section

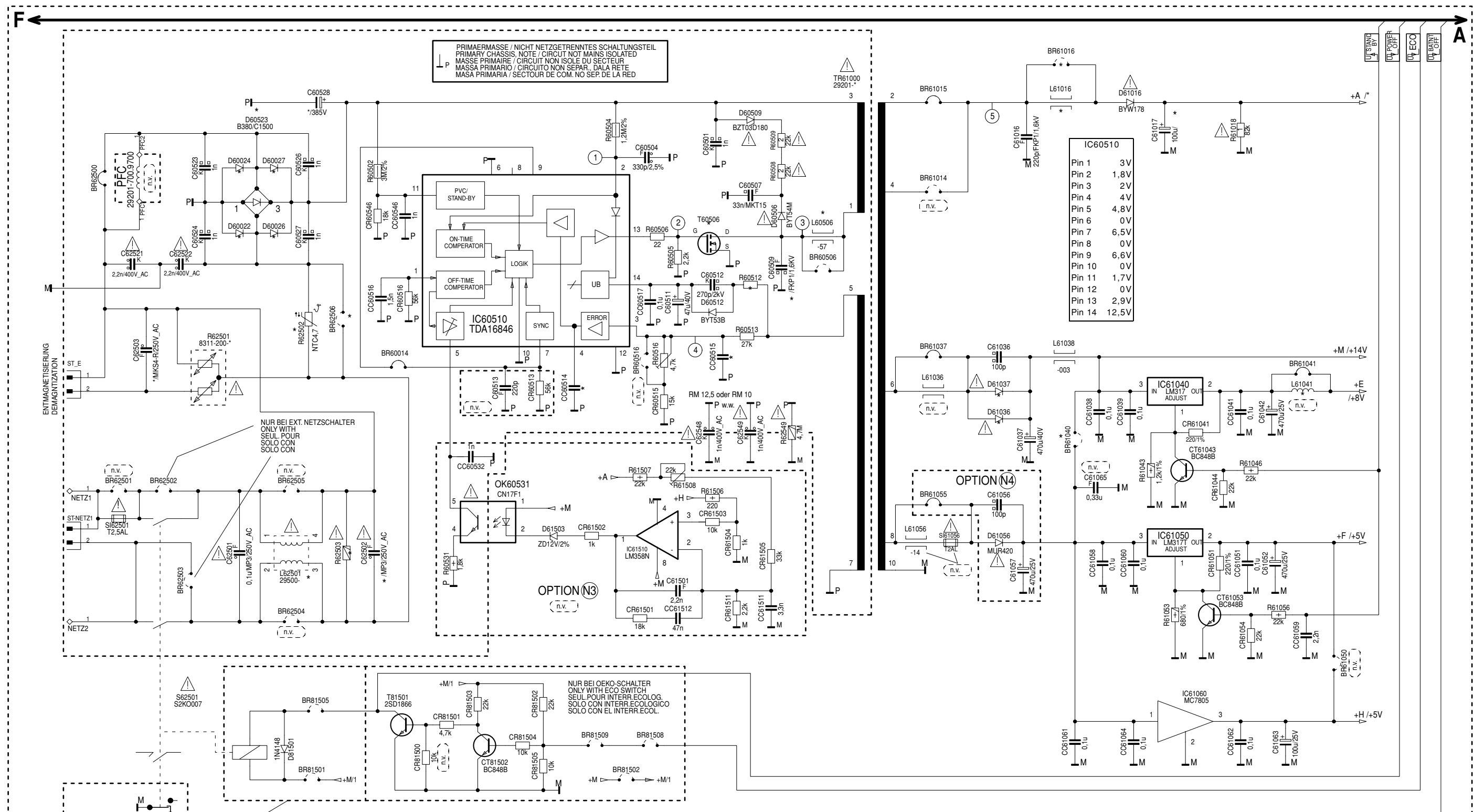

PRIMAERMASSE / NICHT NETZGETRENNTES SCHALTUNGSTEIL
 PRIMARY CHASSIS / CIRCUIT NOT MAINS ISOLATED
 MASSE PRIMAIRE / CIRCUIT NON SEPAR. DALA RETE
 MASA PRIMARIA / SECTOR DE COM. NO SEP. DE LA RED

IC60510

Pin 1	3V
Pin 2	1,8V
Pin 3	2V
Pin 4	4V
Pin 5	4,8V
Pin 6	0V
Pin 7	6,5V
Pin 8	0V
Pin 9	6,6V
Pin 10	0V
Pin 11	1,7V
Pin 12	0V
Pin 13	2,9V
Pin 14	12,5V

NUR BEI EXT. NETZSCHALTER
 ONLY WITH
 SEUL POUR
 SOLO CON
 SOLO CON

OPTION (N3)

OPTION (N4)

NUR BEI OEKO-SCHALTER
 ONLY WITH ECO SWITCH
 SEUL POUR INTER. ECOLOG.
 SOLO CON INTERR. ECOLOGICO
 SOLO CON EL INTERR. ECOL.

OPTION (N1)

NUR BEI OEKO-SCHALTER AUF CHASSIS
 ONLY WITH ECO SWITCH
 SEUL POUR INTERR. ECOLOG.
 SOLO CON INTERR. ECOLOGICO
 SOLO CON EL INTERR. ECOL.

Bei den in den Schaltplänen angegebenen Messwerten handelt es sich um Näherungswerte!
 The measured values given in the circuit diagrams are approximates!

ÄNDERUNGEN VORBEHALTEN
 SUBJECT TO ALTERATION
 SOUS RESERVE DE MODIFIC
 CON RISERVA DI MODIFICA
 RESERV. EL DERECH. DE MODIFIC.

				OPTION	D60022	D60024	D60026	D60027	L60506	T60506	C60509	R60512	CC60514	CC60515	D60523	C60528	TR61000	BR61016	L61016	C61017	D61036	D61037	BR61040	R62501	L62501	C62502	R62502	R62503	C62503	BR62506
37cm PHI	MONO	105V	-	X	-	-	-	-	BUZ90	220p	15	1,5n	39p	X	100u	-523.97	-	-003	160V	MUR420	-	-	-020	826.97	-	-	-	-	0,1u	-
37cm PHI α.TXT	MONO	105V	-	-	1N4007	-	-	-	BUZ90A	220p	15	1,5n	68p	-	47u	-523.97	-	-003	160V	MUR420	-	-	X	-020	823.96	-	X	-	0,1u	X
37cm PHI(12V)	MONO	105V	X	-	-	-	-	-	BUZ90	220p	10	3,3n	68p	X	100u	-523.97	-	-003	160V	MUR420	-	-	X	-	826.97	0,1u	X	3,3M	-	-
37cm PHI/OEM	MONO	132V	-	-	-	-	-	-	BC40	680p	15	3,3n	68p	-	150u	-521.97	-	-	250V	-	-	-	-	-016	826.97	-	X	-	-	-
45cm PHI	MONO	124V	-	X	-	-	-	-	BC40	680p	15	3,3n	68p	X	100u	-524.97	X	-	250V	MUR420	-	-	-	-016	826.97	-	X	-	0,1u	-
51cm SAMS/THO	MONO	124V	-	X	-	-	-	-	BC40	680p	15	3,3n	68p	X	100u	-524.97	X	-	250V	MUR420	-	-	-	-018	826.97	-	X	-	-	-
51cm SAMS(12V)	MONO	124V	X	X	-	-	-	-	BC40	680p	15	3,3n	68p	X	100u	-524.97	X	-	250V	MUR420	-	-	-	-	826.97	-	X	3,3M	0,1u	-
51cm SAM/THO/OEM	MONO	132V	-	X	-	-	-	-	BC40	680p	15	3,3n	68p	-	150u	-521.97	X	-	250V	-	-	-	-	-016	826.97	-	X	-	-	-
55cm PHI/SAMS/THO	MONO	132V	-	X	-	-	-	-	BC40	680p	15	3,3n	68p	X	100u	-521.97	X	-	250V	-	-	-	-	-016	826.97	-	X	-	-	-
55cm PHI/SAMS/THO	STEREO	132V	-	X	-	-	-	-	BC40	680p	15	3,3n	68p	X	150u	-521.97	X	-	250V	-	-	-	-	-016	826.97	-	X	-	-	-
55cm SAM/THO/OEM	MONO	132V	-	X	-	-	-	-	BC40	680p	15	3,3n	68p	-	150u	-521.97	X	-	250V	-	-	-	-	-016	826.97	-	X	-	-	-

Teilschaltplan Ablenkung / Circuit Diagram Deflection Section

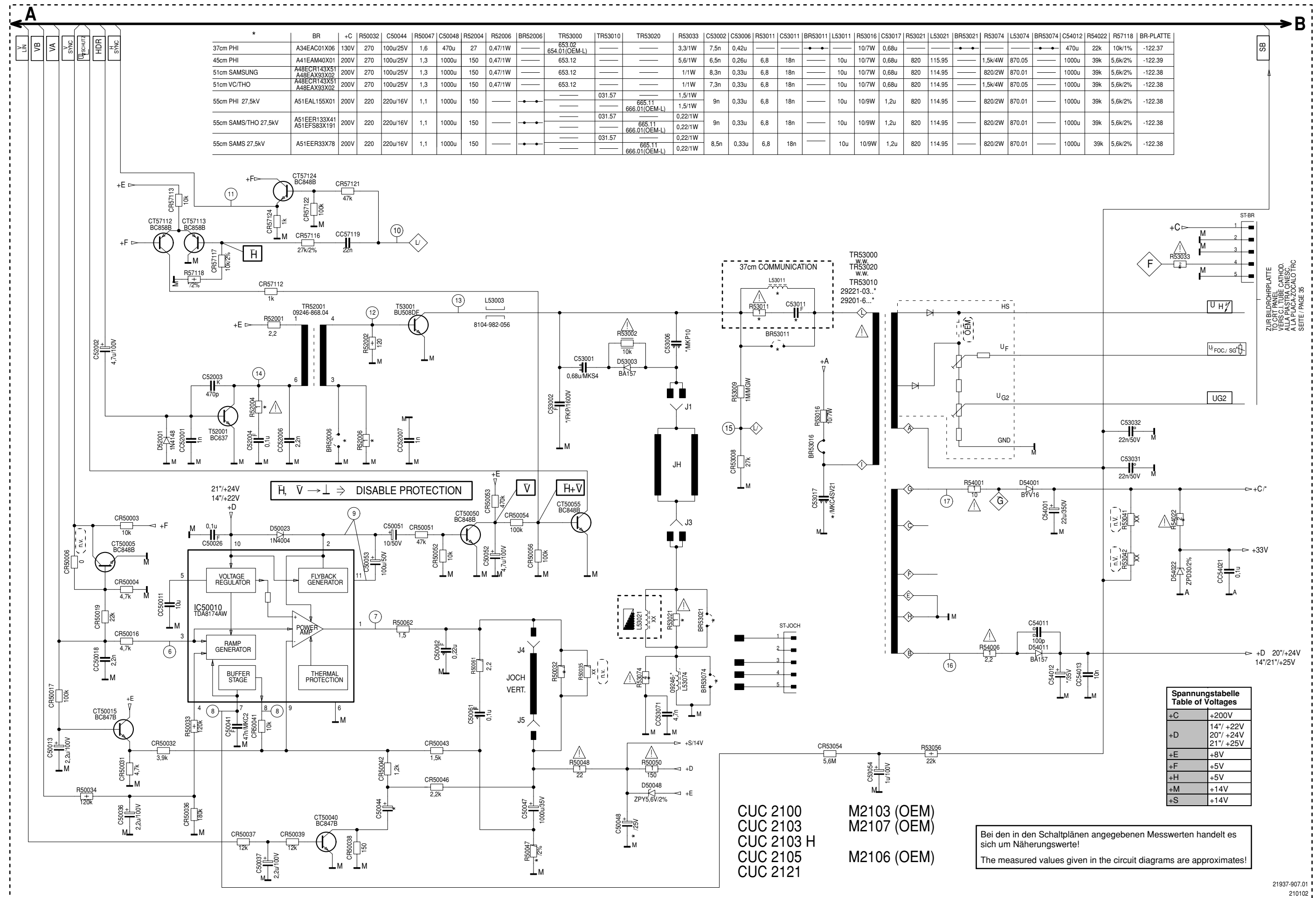

	BR	+C	R50032	C50044	R50047	C50048	R52004	R52006	BR52006	TR53000	TR53010	TR53020	R53033	C53002	C53006	R53011	C53011	BR53011	L53011	R53016	C53017	R53021	L53021	BR53021	R53074	L53074	BR53074	C54012	R54022	R57118	BR-PLATTE	
37cm PHI	A34EAC01X06	130V	270	100u/25V	1,6	470u	27	0,47/1W	—	653.02 654.01(OEM-L)	—	—	3,3/1W	7,5n	0,42u	—	—	—	—	10/7W	0,68u	—	—	—	—	—	—	470u	22k	10k/1%	-122.37	
45cm PHI	A41EAM40X01	200V	270	100u/25V	1,3	1000u	150	0,47/1W	—	653.12	—	—	5,6/1W	6,5n	0,26u	6,8	18n	—	—	10u	10/7W	0,68u	820	115.95	—	1,5k/4W	870.05	—	1000u	39k	5,6k/2%	-122.39
51cm SAMSUNG	A48EAX93X02	200V	270	100u/25V	1,3	1000u	150	0,47/1W	—	653.12	—	—	1/1W	8,3n	0,33u	6,8	18n	—	—	10u	10/7W	0,68u	820	114.95	—	820/2W	870.05	—	1000u	39k	5,6k/2%	-122.38
51cm VC/THO	A48EAX93X02	200V	270	100u/25V	1,3	1000u	150	0,47/1W	—	653.12	—	—	1/1W	7,3n	0,33u	6,8	18n	—	—	10u	10/7W	0,68u	820	114.95	—	1,5k/4W	870.05	—	1000u	39k	5,6k/2%	-122.38
55cm PHI 27.5kV	A51EAL155X01	200V	220	220u/16V	1,1	1000u	150	—	—	—	031.57	—	1,5/1W	9n	0,33u	6,8	18n	—	—	10u	10/9W	1,2u	820	114.95	—	820/2W	870.05	—	1000u	39k	5,6k/2%	-122.38
55cm SAMS/THO 27.5kV	A51EER133X41 A51EFS83X191	200V	220	220u/16V	1,1	1000u	150	—	—	—	031.57	—	1,5/1W	9n	0,33u	6,8	18n	—	—	10u	10/9W	1,2u	820	114.95	—	820/2W	870.05	—	1000u	39k	5,6k/2%	-122.38
55cm SAMS 27.5kV	A51EER33X78	200V	220	220u/16V	1,1	1000u	150	—	—	—	031.57	—	1,5/1W	8,5n	0,33u	6,8	18n	—	—	10u	10/9W	1,2u	820	114.95	—	820/2W	870.05	—	1000u	39k	5,6k/2%	-122.38

**Spannungstabelle
Table of Voltages**

+C	+200V
+D	14"/+22V 20"/+24V 21"/+25V
+E	+8V
+F	+5V
+H	+5V
+M	+14V
+S	+14V

Bei den in den Schaltplänen angegebenen Messwerten handelt es sich um Näherungswerte!
The measured values given in the circuit diagrams are approximates!

CUC 2100
CUC 2103
CUC 2103 H
CUC 2105
CUC 2121

M2103 (OEM)
M2107 (OEM)
M2106 (OEM)

ZUR BILDROHRPLATTE
TO CRT PANEL CATHOD.
ALLA PIASTRINA CINESCO
A LA PLACA ZOCALOTR.C
SEITE / PAGE 35

Teilschaltplan Prozessor / Circuit Diagram Processor Section

*** oder OPTION – siehe Seite 29
*** or OPTION – see page 29

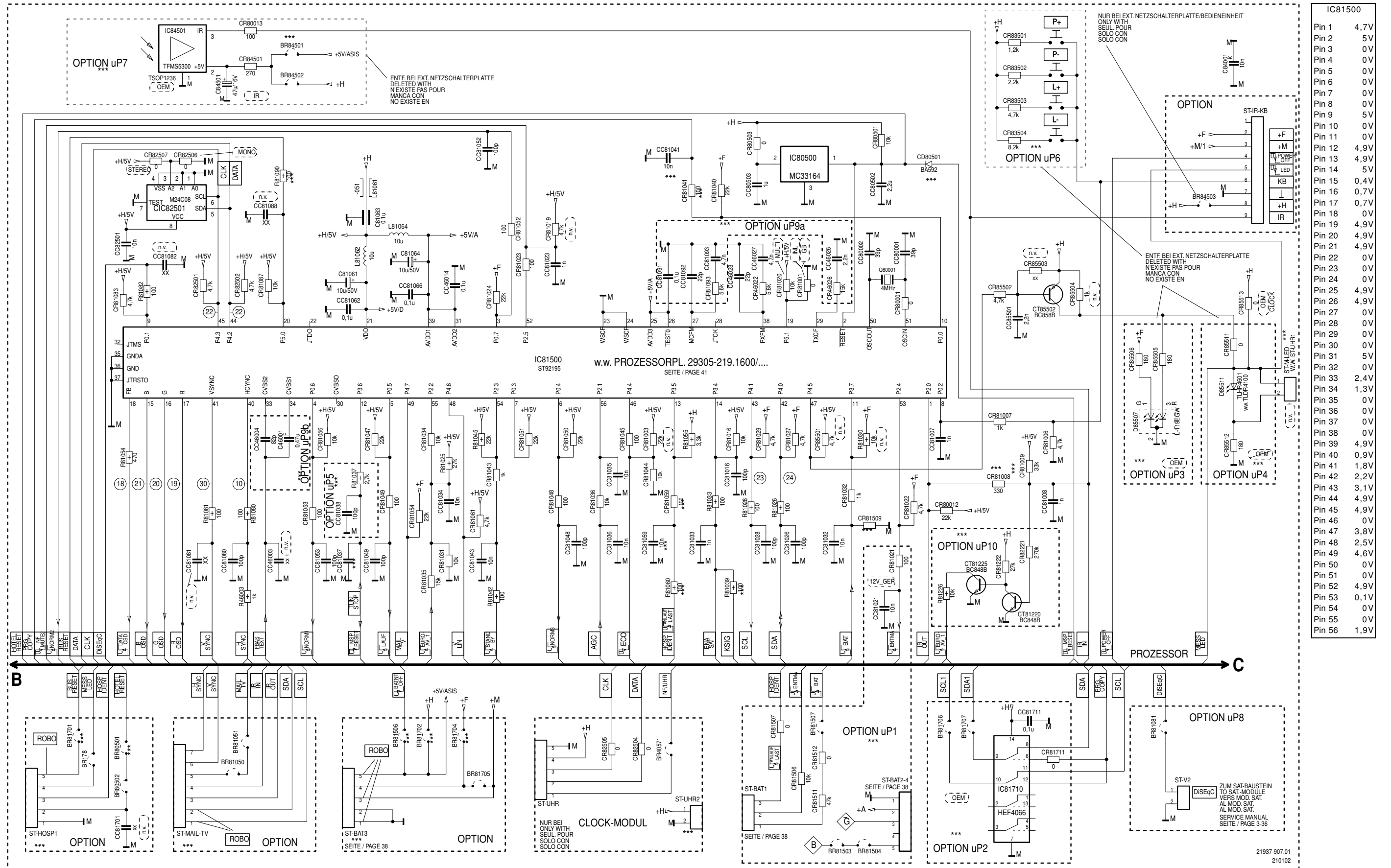

Pin	Voltage
Pin 1	4,7V
Pin 2	5V
Pin 3	0V
Pin 4	0V
Pin 5	0V
Pin 6	0V
Pin 7	0V
Pin 8	0V
Pin 9	5V
Pin 10	0V
Pin 11	0V
Pin 12	4,9V
Pin 13	4,9V
Pin 14	5V
Pin 15	0,4V
Pin 16	0,7V
Pin 17	0,7V
Pin 18	0V
Pin 19	4,9V
Pin 20	4,9V
Pin 21	4,9V
Pin 22	0V
Pin 23	0V
Pin 24	0V
Pin 25	4,9V
Pin 26	4,9V
Pin 27	0V
Pin 28	0V
Pin 29	0V
Pin 30	0V
Pin 31	5V
Pin 32	0V
Pin 33	2,4V
Pin 34	1,3V
Pin 35	0V
Pin 36	0V
Pin 37	0V
Pin 38	0V
Pin 39	4,9V
Pin 40	0,9V
Pin 41	1,8V
Pin 42	2,2V
Pin 43	3,1V
Pin 44	4,9V
Pin 45	4,9V
Pin 46	0V
Pin 47	3,8V
Pin 48	2,5V
Pin 49	4,6V
Pin 50	0V
Pin 51	0V
Pin 52	4,9V
Pin 53	0,1V
Pin 54	0V
Pin 55	0V
Pin 56	1,9V

Bei den in den Schaltplänen angegebenen Messwerten handelt es sich um Näherungswerte!
The measured values given in the circuit diagrams are approximates!

Teilschaltplan Video / Circuit Diagram Video Section

*** oder OPTION – siehe Seite 29
*** or OPTION – see page 29

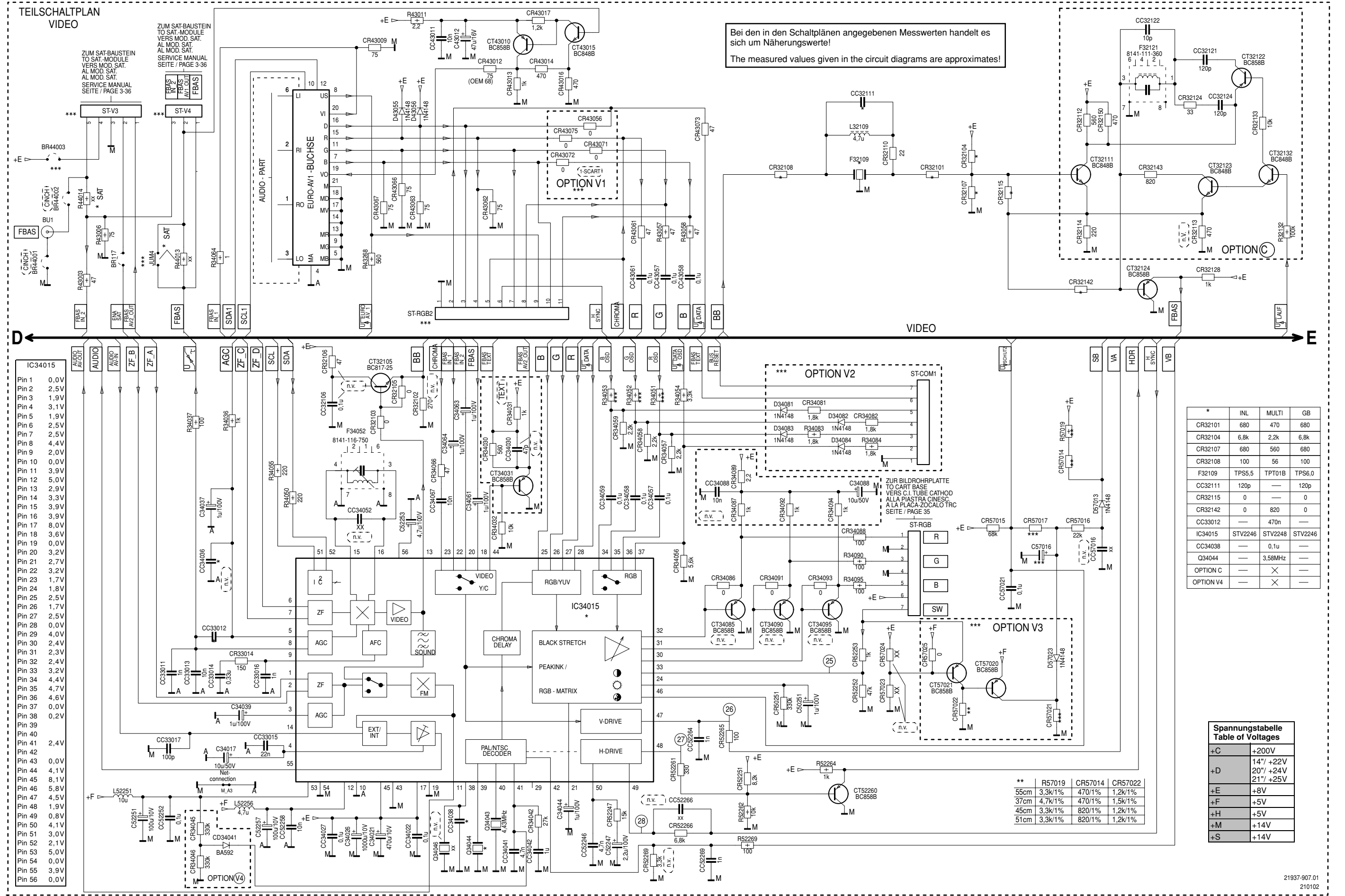

Teilschaltplan Audio / Circuit Diagram Audio

Bei den in den Schaltplänen angegebenen Messwerten handelt es sich um Näherungswerte!
The measured values given in the circuit diagrams are approximates!

*** oder OPTION – siehe Seite 29
*** or OPTION – see page 29

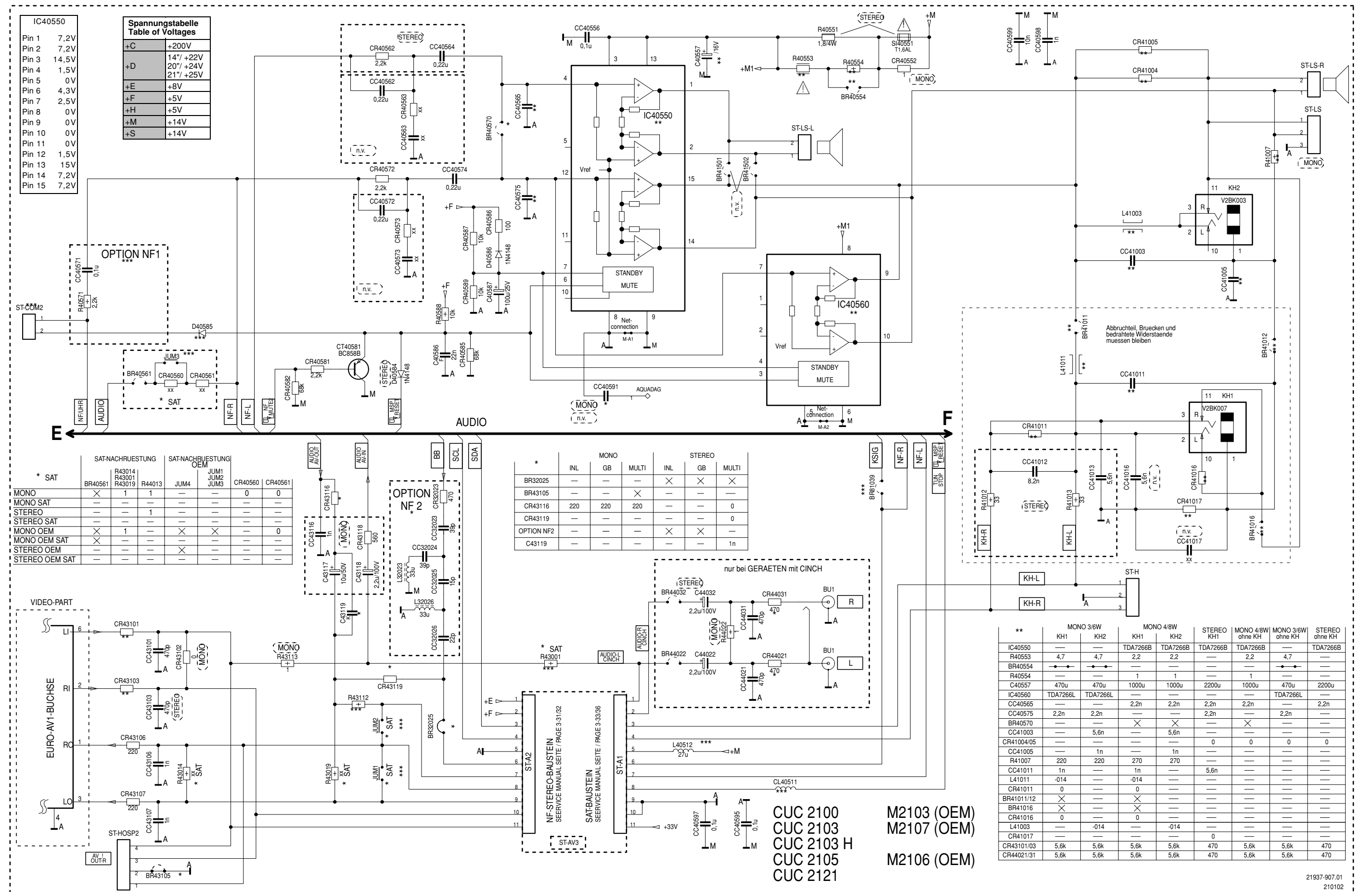

IC40550

Pin 1	7,2V
Pin 2	7,2V
Pin 3	14,5V
Pin 4	1,5V
Pin 5	0V
Pin 6	4,3V
Pin 7	2,5V
Pin 8	0V
Pin 9	0V
Pin 10	0V
Pin 11	0V
Pin 12	1,5V
Pin 13	15V
Pin 14	7,2V
Pin 15	7,2V

Spannungstabelle
Table of Voltages

+C	+200V
+D	14"/ +22V 20"/ +24V 21"/ +25V
+E	+8V
+F	+5V
+H	+5V
+M	+14V
+S	+14V

*	MONO			STEREO		
	INL	GB	MULTI	INL	GB	MULTI
BR32025				X	X	X
BR43105			X			
CR43116	220	220	220			0
CR43119				X	X	
OPTION NF2				X	X	
C43119						1n

**	MONO 3/6W		MONO 4/8W		STEREO KH1	MONO 4/8W ohne KH	MONO 3/6W ohne KH	STEREO ohne KH
	KH1	KH2	KH1	KH2	TDA7266B	TDA7266B	TDA7266L	TDA7266B
IC40550	—	—	—	—	—	—	—	—
R40553	4,7	4,7	2,2	2,2	—	2,2	4,7	—
BR40554	—	—	—	—	—	—	—	—
R40554	—	—	1	1	—	1	—	—
C40557	470u	470u	1000u	1000u	2200u	1000u	470u	2200u
IC40560	TDA7266L	TDA7266L	—	—	—	—	—	—
CC40565	—	—	2,2n	2,2n	2,2n	2,2n	—	2,2n
CC40575	2,2n	2,2n	—	—	2,2n	—	2,2n	—
BR40570	—	—	X	X	—	X	—	—
CC41003	—	5,6n	—	5,6n	—	—	—	—
CR41004/05	—	—	—	—	0	0	0	0
CC41005	—	1n	—	1n	—	—	—	—
R41007	220	220	270	270	—	—	—	—
CC41011	1n	—	1n	—	5,6n	—	—	—
L41011	-014	—	-014	—	—	—	—	—
CR41011	0	—	0	—	—	—	—	—
BR41011/12	X	—	X	—	—	—	—	—
BR41016	X	—	X	—	—	—	—	—
CR41016	0	—	0	—	—	—	—	—
L41003	—	-014	—	-014	—	—	—	—
CR41017	—	—	—	—	0	—	—	—
CR43101/03	5,6k	5,6k	5,6k	5,6k	470	5,6k	5,6k	470
CR44021/31	5,6k	5,6k	5,6k	5,6k	470	5,6k	5,6k	470

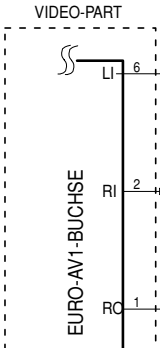

CUC 2100
CUC 2103
CUC 2103 H
CUC 2105
CUC 2121

M2103 (OEM)
M2107 (OEM)
M2106 (OEM)

Baustein Netzteil 12V / Module Mains Unit 12V 293050073400

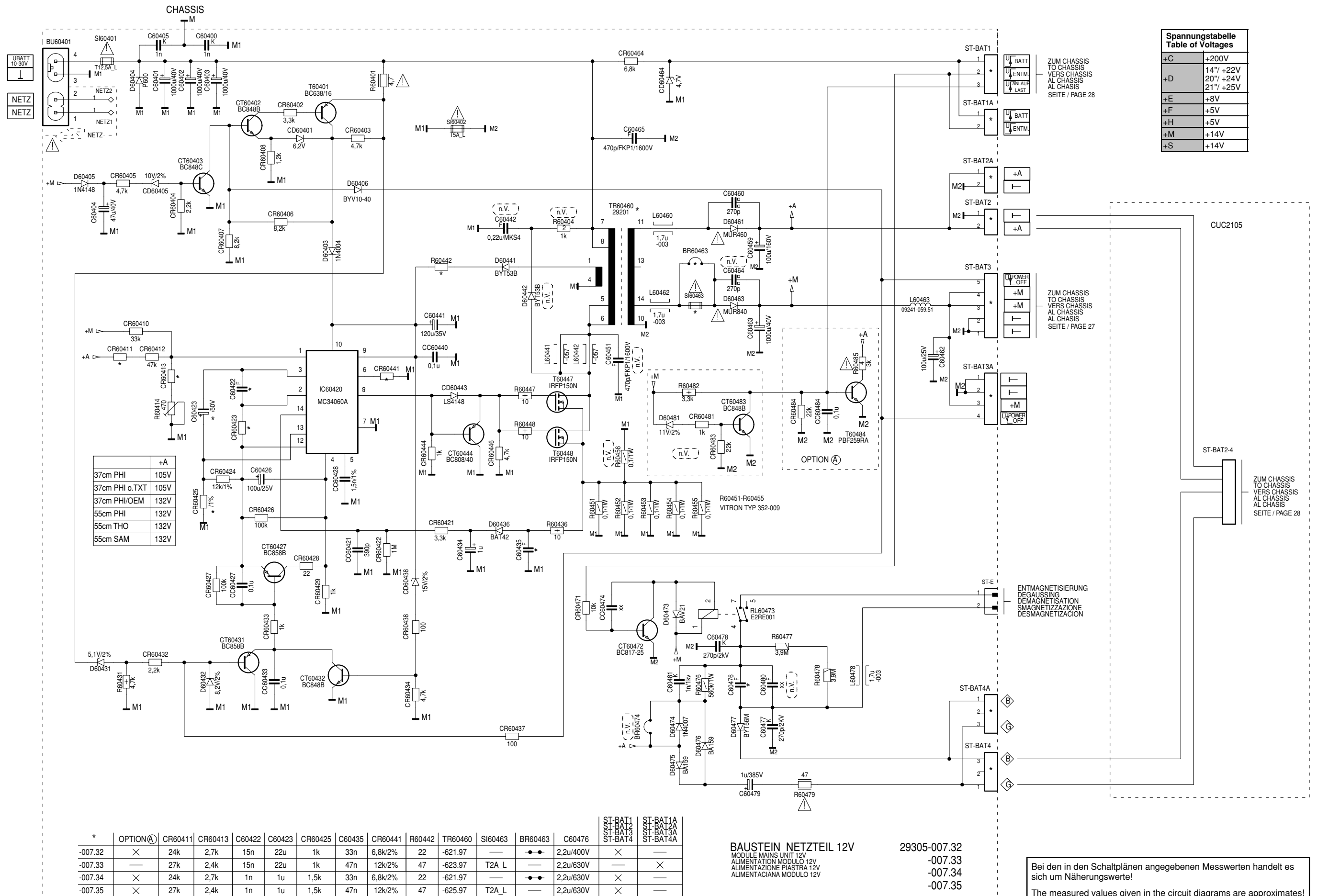

*	OPTION (A)	CR60411	CR60413	C60422	C60423	CR60425	C60435	CR60441	R60442	TR60460	SI60463	BR60463	C60476	ST-BAT1	ST-BAT1A
-007.32	×	24k	2.7k	15n	22u	1k	33n	6.8k/2%	22	-621.97	—	●●	2.2u/400V	×	—
-007.33	—	27k	2.4k	15n	22u	1k	47n	12k/2%	47	-623.97	T2A_L	—	2.2u/630V	—	×
-007.34	×	24k	2.7k	1n	1u	1.5k	33n	6.8k/2%	22	-621.97	—	●●	2.2u/630V	×	—
-007.35	×	27k	2.4k	1n	1u	1.5k	47n	12k/2%	47	-625.97	T2A_L	—	2.2u/630V	×	—

Bestückungsseite / Component Side

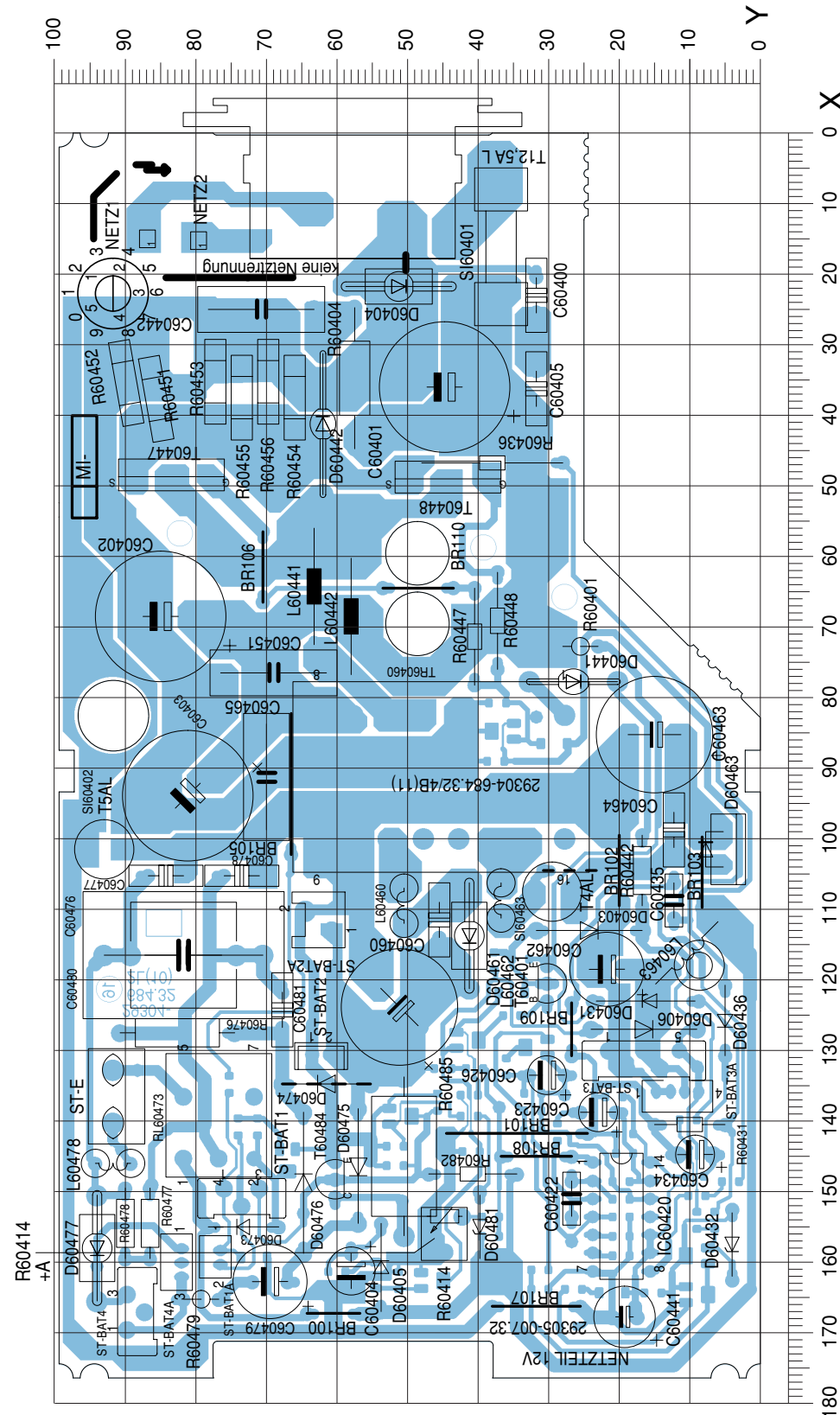

	+A
37cm PHI	105V
37cm PHI o.TXT	105V
37cm PHI/OEM	132V
55cm PHI	132V
55cm THO	132V
55cm SAM	132V

Pos.-Nr./ Pos. No.	Koordinaten/ Coordinates	
	X	Y

C60480	117	82
C60481	124	68
D60403	113	24
D60404	22	51
D60405	161	54
D60406	127	16
D60431	123	16
D60432	158	4
D60436	126	5
D60441	78	27
D60442	41	62
D60461	114	41
D60463	101	5
D60473	155	73
D60474	135	62
D60475	146	57
D60476	149	65
D60477	158	94
D60481	155	40
IC60420	153	20
L60441	64	63
L60442	69	58
L60460	109	51
L60462	109	37
L60463	118	9
L60478	146	92
NETZ01	15	87
NETZ02	15	80
R60401	73	25
R60404	35	58
R60414	156	45
R60431	141	10
R60436	47	38
R60442	105	17
R60447	71	41
R60448	69	37
R60451	38	86
R60452	35	90
R60453	35	77
R60454	38	66
R60455	38	73
R60456	35	70
R60476	127	83
R60477	155	86
R60478	155	90
R60479	165	79
R60482	148	41
R60485	145	51
RL60473	139	77
SI60401	16	37
SI60402	101	93
SI60463	108	30
ST-BAT02	131	62
ST-BAT01	151	73
ST-BAT04	167	88
ST-BAT03	131	16
ST-BAT02A	111	63
ST-BAT01A	159	77
ST-BAT04A	160	83
ST-BAT03A	136	12
ST-E	136	91
T60401	120	30
T60447	48	83
T60448	49	64
T60484	148	41
T60476	117	82
T60477	105	94
T60478	105	73
T60479	163	69
TR60460	91	45

Pos.-Nr./ Pos. No.	Koordinaten/ Coordinates		Pos.-Nr./ Pos. No.	Koordinaten/ Coordinates		Pos.-Nr./ Pos. No.	Koordinaten/ Coordinates		Pos.-Nr./ Pos. No.	Koordinaten/ Coordinates		Pos.-Nr./ Pos. No.	Koordinaten/ Coordinates	
	X	Y		X	Y		X	Y		X	Y		X	Y
BR100	167	61	BR109	127	27	C60401	36	44	C60434	145	9	C60462	118	21
BR101	142	35	BR110	65	48	C60402	69	84	C60463	85	14	C60463	85	14
BR102	105	20				C60403	93	81	C60464	99	12	C60464	99	12
BR103	105	8	BR60463	105	27	C60404	161	58	C60441	168	19	C60465	91	70
BR105	92	67	BR60474	135	62				C60442	25	71			
						C60405	36	32	C60451	77	69			
BR106	62	71	BU60401	6	58	C60422	151	27	C60459	124	51			
BR107	166	32				C60423	139	23						
BR108	145	32	C60400	23	32	C60426	134	30						

Bestückungsseite (SMD) / Component Side (SMD)

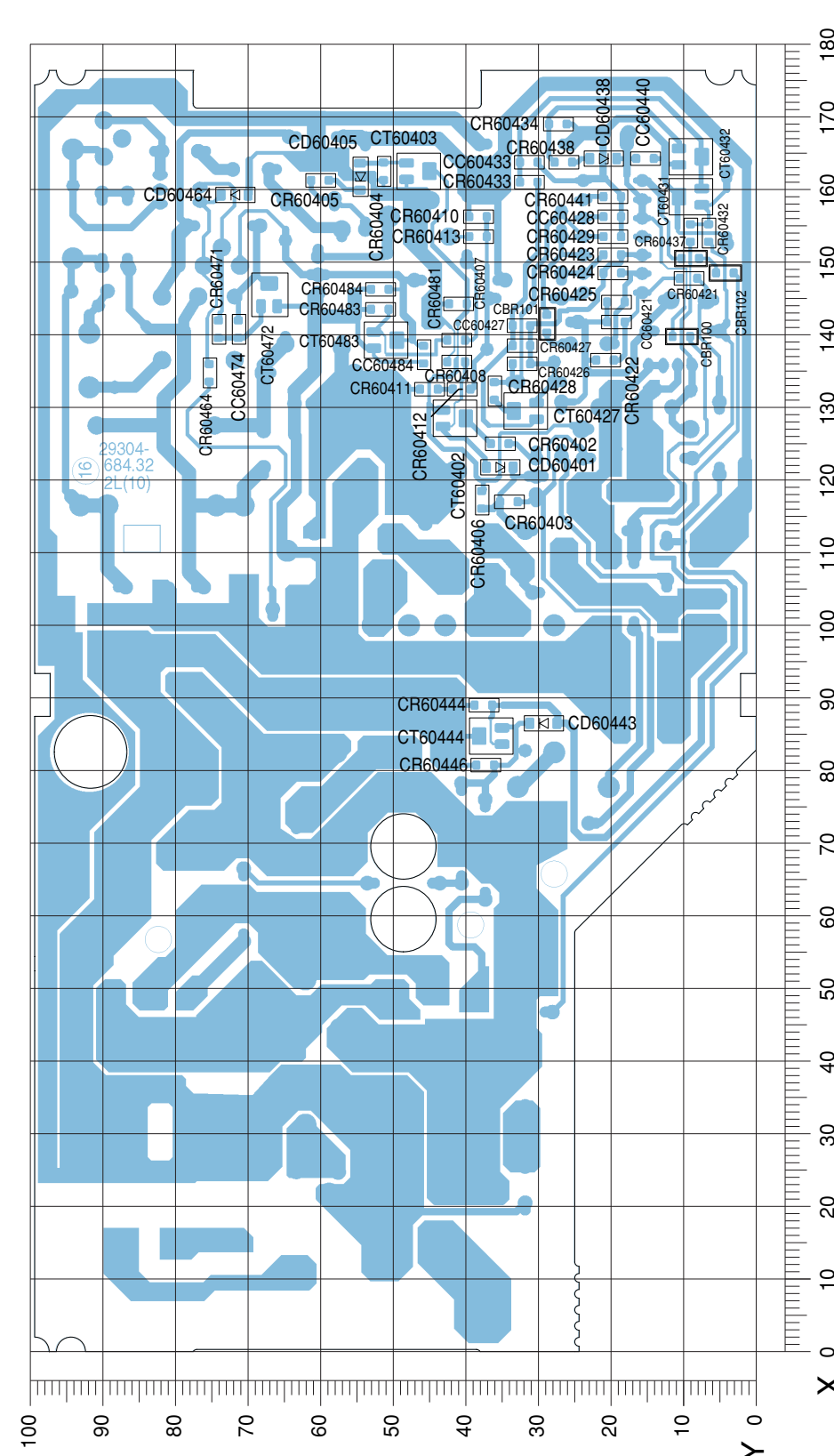

Pos.-Nr./ Pos. No.	Koordinaten/ Coordinates	
	X	Y

CR60427	139	32
CR60428	132	36
CR60429	153	20
CR60432	154	7
CR60433	161	31
CR60434	169	27
CR60437	154	9
CR60438	164	27
CR60441	159	20
CR60444	89	38
CR60446	81	37
CR60464	135	75
CR60471	141	74
CR60481	139	41
CR60483	143	52
CR60484	146	52
CT60402	128	42
CT60403	163	47
CT60427	130	32
CT60431	159	9
CT60432	165	9
CT60444	85	37
CT60472	145	67
CT60483	139	51

Pos.-Nr./ Pos. No.	Koordinaten/ Coordinates		Pos.-Nr./ Pos. No.	Koordinaten/ Coordinates		Pos.-Nr./ Pos. No.	Koordinaten/ Coordinates		Pos.-Nr./ Pos. No.	Koordinaten/ Coordinates		Pos.-Nr./ Pos. No.	Koordinaten/ Coordinates	
	X	Y		X	Y		X	Y		X	Y		X	Y
CD60405	142	19	CC60433	164	31	CD60438	164	21	CR60406	117	38	CR60413	153	38
CD60427	141	32	CC60440	164	15	CD60443	86	29	CR60421	148	9	CR60421	148	9
CD60428	156	20	CC60474	141	71	CD60464	159	72	CR60422	136	21	CR60422	136	21
			CC60484	137	46				CR60423	151	20	CR60423	151	20
						CR60402	125	35	CR60424	149	20	CR60424	149	20
						CR60403	117	34						
						CR60404	163	51	CR60411	133	45	CR60425	144	19
						CR60405	161	60	CR60412	133	41	CR60426	136	32

Prozessor-Platte / Processing Board
293052191600 / 2500 / 2600 / 2700 / 3000 / 3300 / 3700 / 4100 / 4200

PROZESSORMODUL 29305-219.1600 219.3000 219.4100
 PROCESSING BOARD 219.1700 219.3100 219.4200
 PLAQUE CALCULATEUR 219.1900 219.3200 219.4300
 PIASTRA CALCOLATORE 219.2000 219.3300 219.4400
 PLACA CALCULADOR 219.2100 219.3500 219.4500
 219.2200 219.3600
 219.2500 219.3700
 219.2600 219.3800
 219.2700
 219.2800

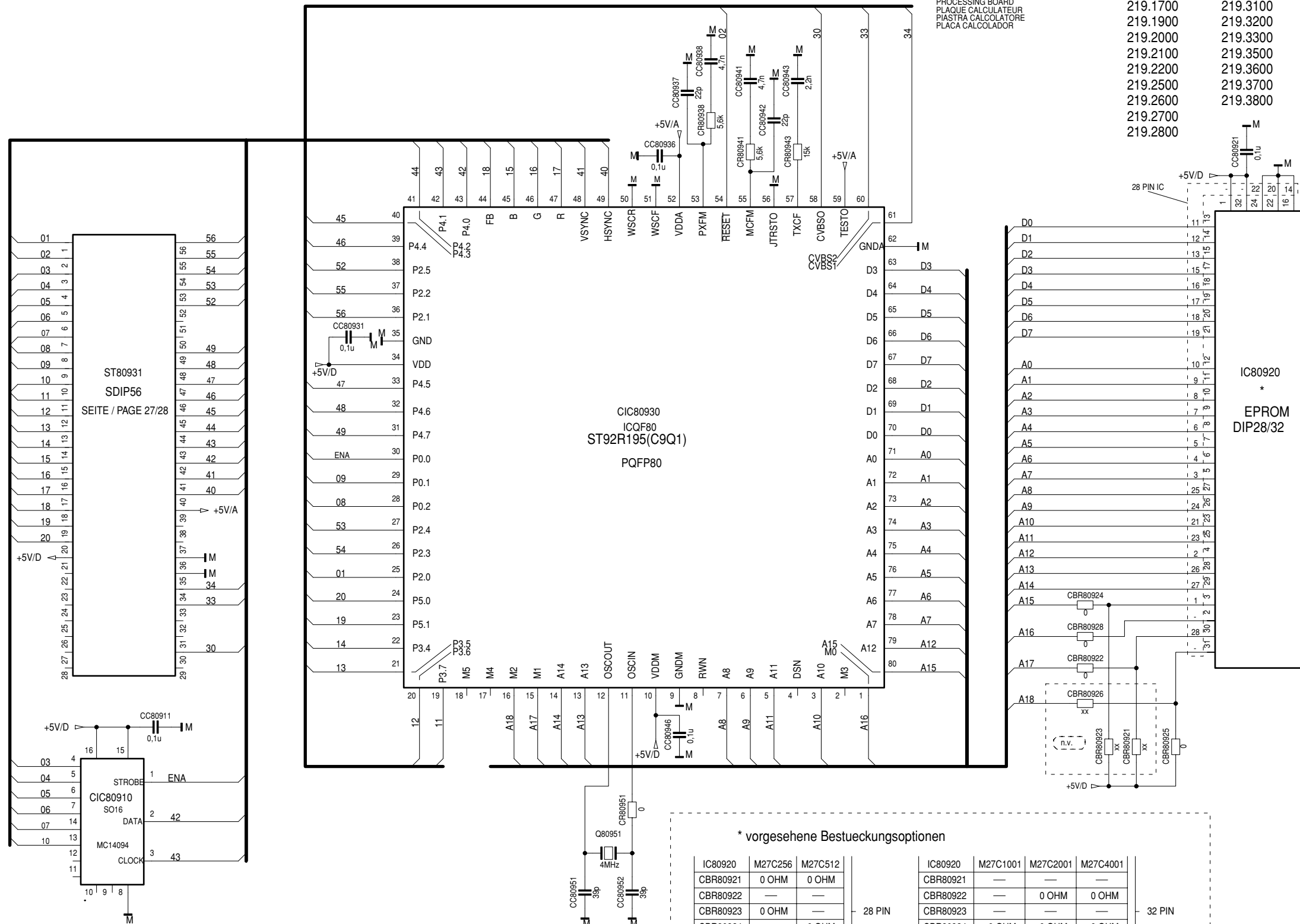

*	IC80920 / EPROM		
	SNR	TYP	PIN
29305-219.1600	29798-012.xx	M27C2001	32
29305-219.1700	29798-013.xx	M27C2001	32
29305-219.1900	29798-015.xx	M27C2001	32
29305-219.2000	29798-016.xx	M27C2001	32
29305-219.2100	29798-017.xx	M27C2001	32
29305-219.2200	29798-018.xx	M27C2001	32
29305-219.2500	29798-019.xx	M27C2001	32
29305-219.2600	29798-020.xx	M27C2001	32
29305-219.2700	29798-019.xx	M27C2001	32
29305-219.2800	29798-013.xx	M27C2001	32
29305-219.3000	29798-020.xx	M27C2001	32
29305-219.3100	29798-024.xx	M27C2001	32
29305-219.3200	29798-025.xx	M27C2001	32
29305-219.3300	29798-026.xx	M27C2001	32
29305-219.3500	29798-021.xx	M27C2001	32
29305-219.3600	29798-023.xx	M27C2001	32
29305-219.3700	29798-028.xx	M27C2001	32
29305-219.3800	29798-029.xx	M27C2001	32
29305-219.4100	29798-031.xx	M27C2001	32
29305-219.4200	29798-032.xx	M27C2001	32
29305-219.4300	29798-033.xx	M27C2001	32
29305-219.4400	29798-034.xx	M27C2001	32
29305-219.4500	29798-035.xx	M27C2001	32

* vorgesehene Bestueckungsoptionen

IC80920	M27C256	M27C512	IC80920	M27C1001	M27C2001	M27C4001
CBR80921	0 OHM	0 OHM	CBR80921	—	—	—
CBR80922	—	—	CBR80922	—	0 OHM	0 OHM
CBR80923	0 OHM	—	CBR80923	—	—	—
CBR80924	—	0 OHM	CBR80924	0 OHM	0 OHM	0 OHM
CBR80925	—	—	CBR80925	0 OHM	0 OHM	—
CBR80926	—	—	CBR80926	—	—	0 OHM
CBR80928	—	—	CBR80928	0 OHM	0 OHM	0 OHM

Bestückungsseite / Component Side

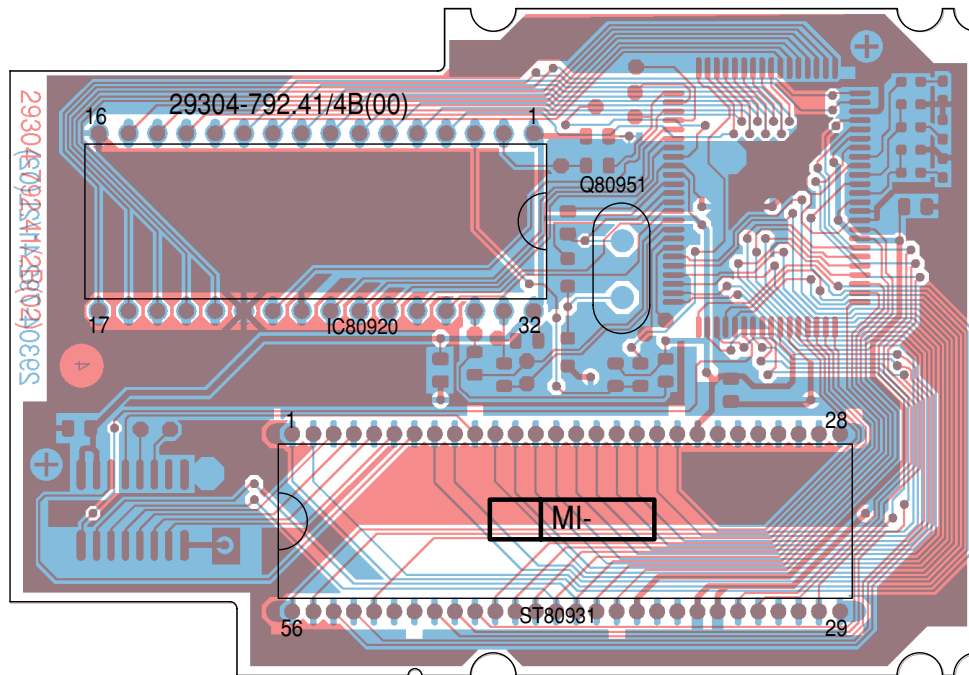

Bestückungsseite (SMD) / Component Side (SMD)

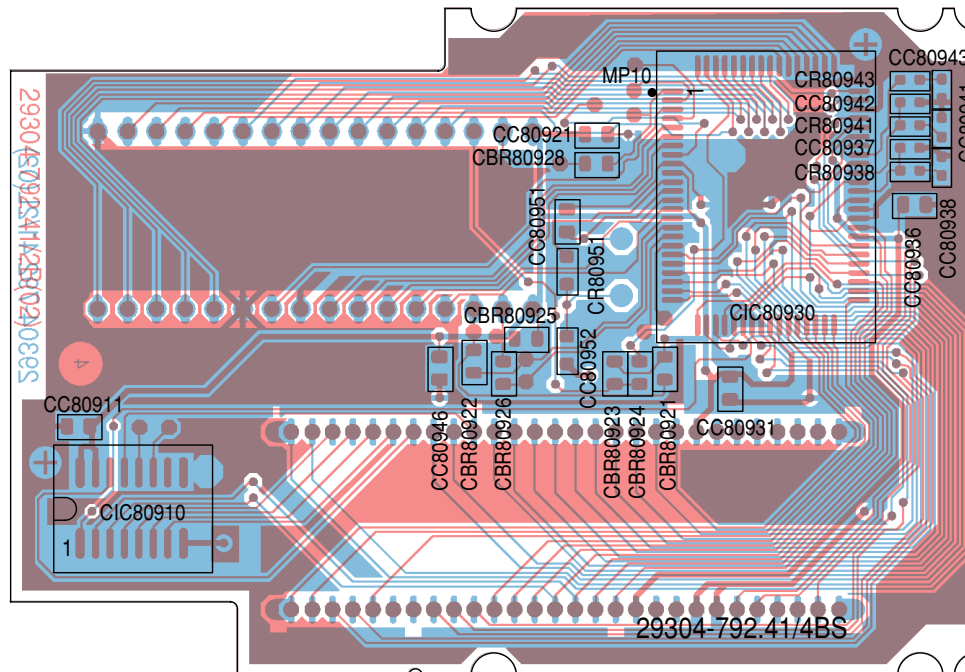

Ersatzteilliste
Spare Parts List

TV

12 / 2001

DAVIO 37 P 37-4101 TOP

MATERIAL-NR. / PART NO.: 921977010200 BESTELL-NR. / ORDER NO.: GCL6100 AGANAGRAU/AGANAGREY
VERSION NR./VERSION NO.: VNX

POS. NR. ABB. POS. NO. FIG.	MATERIAL-NR. PART NUMBER	ANZ. QTY.	BEZEICHNUNG (D)	DESCRIPTION (GB)
	921977010200		DAVIO 37 P 37-4101 TOP AGANAGRAU KEIN E-TEIL	DAVIO 37 P 37-4101 TOP AGANAGREY NO SPARE PART
0320.000	291104016503		TYPENAUFKLEBER VNX	TYPE LABEL VNX
	219779411400 219779411500 720100407000 720100407400		BEDIENUNGSANLEITUNG D//GB/NL/DK BEDIENUNGSANLEITUNG P/S/FIN/E/GR SERVICE MANUAL D/GB SERVICE MANUAL D/GB 4.ERGAENZUNG	OPERATING INSTRUCTIONS D//GB/NL/DK OPERATING INSTRUCTIONS P/S/FIN/E/GR SERVICE MANUAL D/GB SERVICE MANUAL D/GB 4TH SUPPLEMENT
	297040126500	X	CHASSIS-FS-MONO CUC 2103 INL KEIN E-TEIL X=SIEHE GESONDERTE E-LISTE ALLE WEITEREN TEILE SIEHE E-LISTE DAVIO 37 P 37-4101 TOP AGANAGRAU MAT.-NR.: 921977010200 BESTELL-NR.: GCL6100 AUSGABE 1/2001 VERSION NR.: VNM SIEHE SERVICE MANUAL D/GB 1.ERG.	CHASSIS TV MONO CUC 2103 INL NO SPARE PART X=SEE SEPARATE PARTS LIST FOR ALL OTHER PARTS SEE DAVIO 37 P 37-4101 TOP AGANAGREY PART NO: 921977010200 ORDER NR: GCL6100 EDITION 1/2001 VERSION NO.: VNM SEE SERVICE MANUAL D/GB 1TH SUPPL.
	720100407100			

Es gelten die Vorschriften und Sicherheitshinweise gemäß dem Service Manual "Sicherheit", Mat.-Nummer 720108000000, sowie zusätzlich die eventuell abweichenden, landesspezifischen Vorschriften!



The regulations and safety instructions shall be valid as provided by the "Safety" Service Manual, part number 720108000000, as well as the respective national deviations.

ÄNDERUNGEN VORBEHALTEN / SUBJECT TO ALTERATION

Ersatzteilliste
Spare Parts List

TV

12 / 2001

DAVIO 37 P 37-4101 TOP

MATERIAL-NR. / PART NO.: 921977014100 BESTELL-NR. / ORDER NO.: GCL6110 ICE BLUE
VERSION NR./VERSION NO.: VNX

POS. NR. ABB. POS. NO. FIG.	MATERIAL-NR. PART NUMBER	ANZ. QTY.	BEZEICHNUNG (D)	DESCRIPTION (GB)
	921977014100		DAVIO 37 P 37-4101 TOP ICE BLUE KEIN E-TEIL	DAVIO 37 P 37-4101 TOP ICE BLUE NO SPARE PART
0320.000 2410.000	291104016503 720086738000		TYPENAUFKLEBER VNX DECKEL BATTERIE TP 750 C	TYPE LABEL VNX BATTERY LID TP 750 C
	219779411400 219779411500 720100407000 720100407400		BEDIENUNGSANLEITUNG D//GB/NL/DK BEDIENUNGSANLEITUNG P/S/FIN/E/GR SERVICE MANUAL D/GB SERVICE MANUAL D/GB 4.ERGAENZUNG	OPERATING INSTRUCTIONS D//GB/NL/DK OPERATING INSTRUCTIONS P/S/FIN/E/GR SERVICE MANUAL D/GB SERVICE MANUAL D/GB 4TH SUPPLEMENT
	297040126500	X	CHASSIS-FS-MONO CUC 2103 INL KEIN E-TEIL X=SIEHE GESONDERTE E-LISTE ALLE WEITEREN TEILE SIEHE E-LISTE DAVIO 37 P 37-4101 TOP ICE BLUE MAT.-NR.: 921977014100 BESTELL-NR.: GCL6110 AUSGABE 3/2001 VERSION NR.: VNM SIEHE SERVICE MANUAL D/GB 1.ERG.	CHASSIS TV MONO CUC 2103 INL NO SPARE PART X=SEE SEPARATE PARTS LIST FOR ALL OTHER PARTS SEE DAVIO 37 P 37-4101 TOP ICE BLUE PART NO: 921977014100 ORDER NR: GCL6110 EDITION 3/2001 VERSION NO.: VNM SEE SERVICE MANUAL D/GB 1TH SUPPL.
	720100407100			

Es gelten die Vorschriften und Sicherheitshinweise gemäß dem Service Manual "Sicherheit", Mat.-Nummer 720108000000, sowie zusätzlich die eventuell abweichenden, landesspezifischen Vorschriften!



The regulations and safety instructions shall be valid as provided by the "Safety" Service Manual, part number 720108000000, as well as the respective national deviations.

ÄNDERUNGEN VORBEHALTEN / SUBJECT TO ALTERATION

GRUNDIGErsatzteilliste
Spare Parts List**TV****12 / 2001****DAVIO 37 P 37-4101 TOP**MATERIAL-NR. / PART NO.: 921977016800 BESTELL-NR. / ORDER NO.: GCL6120 LIGHT GREEN
VERSION NR./VERSION NO.: VNX

POS. NR. POS. NO.	ABB. FIG.	MATERIAL-NR. PART NUMBER	ANZ. QTY.	BEZEICHNUNG (D)	DESCRIPTION (GB)
		921977016800		DAVIO 37 P 37-4101 TOP LIGHT GREEN KEIN E-TEIL	DAVIO 37 P 37-4101 TOP LIGHT GREEN NO SPARE PART
0320.000 2410.000		291104016503 720086738000		TYPENAUFKLEBER VNX DECKEL BATTERIE TP 750 C	TYPE LABEL VNX BATTERY LID TP 750 C
		219779411400 219779411500 720100407000 720100407400		BEDIENUNGSANLEITUNG D//GB/NL/DK BEDIENUNGSANLEITUNG P/S/FIN/E/GR SERVICE MANUAL D/GB SERVICE MANUAL D/GB 4.ERGAENZUNG	OPERATING INSTRUCTIONS D//GB/NL/DK OPERATING INSTRUCTIONS P/S/FIN/E/GR SERVICE MANUAL D/GB SERVICE MANUAL D/GB 4TH SUPPLEMENT
		297040126500	X	CHASSIS-FS-MONO CUC 2103 INL KEIN E-TEIL X-SIEHE GESONDERTE E-LISTE	CHASSIS TV MONO CUC 2103 INL NO SPARE PART X-SEE SEPARATE PARTS LIST
		720100407100		ALLE WEITEREN TEILE SIEHE E-LISTE DAVIO 37 P 37-4101 TOP LIGHT GREEN MAT.-NR.: 921977016800 BESTELL-NR.: GCL6120 AUSGABE 3/2001 VERSION NR.: VNM SIEHE SERVICE MANUAL D/GB 1.ERG.	FOR ALL OTHER PARTS SEE DAVIO 37 P 37-4101 TOP LIGHT GREEN PART NO.: 921977016800 ORDER NR.: GCL6120 EDITION 3/2001 VERSION NO.: VNM SEE SERVICE MANUAL D/GB 1TH SUPPL.

Es gelten die Vorschriften und Sicherheitshinweise gemäß dem Service Manual "Sicherheit", Mat.-Nummer 720108000000, sowie zusätzlich die eventuell abweichenden, landesspezifischen Vorschriften!



The regulations and safety instructions shall be valid as provided by the "Safety" Service Manual, part number 720108000000, as well as the respective national deviations.

ÄNDERUNGEN VORBEHALTEN / SUBJECT TO ALTERATION

GRUNDIGErsatzteilliste
Spare Parts List**TV****12 / 2001****DAVIO 37 P 37-4101 TOP**MATERIAL-NR. / PART NO.: 921977018900 BESTELL-NR. / ORDER NO.: GCL6130 CORONA SILBER/CORONA SILVER
VERSION NR./VERSION NO.: VNX

POS. NR. POS. NO.	ABB. FIG.	MATERIAL-NR. PART NUMBER	ANZ. QTY.	BEZEICHNUNG (D)	DESCRIPTION (GB)
		921977018900		DAVIO 37 P 37-4101 TOP CORONA SILBER KEIN E-TEIL	DAVIO 37 P 37-4101 TOP CORONA SILVER NO SPARE PART
0320.000 2400.000 2410.000		291104016503 296420621800 267280080001		TYPENAUFKLEBER VNX TP 750 C FERNBEDIENUNG SCHWARZ DECKEL BATTERIE TP 750 C	TYPE LABEL VNX TP 750 C REMOTE CONTROL BLACK BATTERY LID TP 750 C
		219779411400 219779411500 720100407000 720100407400		BEDIENUNGSANLEITUNG D//GB/NL/DK BEDIENUNGSANLEITUNG P/S/FIN/E/GR SERVICE MANUAL D/GB SERVICE MANUAL D/GB 4.ERGAENZUNG	OPERATING INSTRUCTIONS D//GB/NL/DK OPERATING INSTRUCTIONS P/S/FIN/E/GR SERVICE MANUAL D/GB SERVICE MANUAL D/GB 4TH SUPPLEMENT
		297040126500	X	CHASSIS-FS-MONO CUC 2103 INL KEIN E-TEIL X-SIEHE GESONDERTE E-LISTE	CHASSIS TV MONO CUC 2103 INL NO SPARE PART X-SEE SEPARATE PARTS LIST
		720100407100		ALLE WEITEREN TEILE SIEHE E-LISTE DAVIO 37 P 37-4101 TOP CORONA SILBER MAT.-NR.: 921977018900 BESTELL-NR.: GCL6130 AUSGABE 3/2001 VERSION NR.: VNM SIEHE SERVICE MANUAL D/GB 1.ERG.	FOR ALL OTHER PARTS SEE DAVIO 37 P 37-4101 TOP CORONA SILVER PART NO.: 921977018900 ORDER NR.: GCL6130 EDITION 3/2001 VERSION NO.: VNM SEE SERVICE MANUAL D/GB 1TH SUPPL.

Es gelten die Vorschriften und Sicherheitshinweise gemäß dem Service Manual "Sicherheit", Mat.-Nummer 720108000000, sowie zusätzlich die eventuell abweichenden, landesspezifischen Vorschriften!



The regulations and safety instructions shall be valid as provided by the "Safety" Service Manual, part number 720108000000, as well as the respective national deviations.

ÄNDERUNGEN VORBEHALTEN / SUBJECT TO ALTERATION

Ersatzteilliste
Spare Parts List

TV

12 / 2001

DAVIO 37 P 37-4101 TOP/1

MATERIAL-NR. / PART NO.: 921977230200 BESTELL-NR. / ORDER NO.: GCL6101 AGANAGRAU/AGANAGREY
VERSION NR./VERSION NO.: VNX

POS. NR. ABB. POS. NO. FIG.	MATERIAL-NR. PART NUMBER	ANZ. QTY.	BEZEICHNUNG (D)	DESCRIPTION (GB)
	921977230200		DAVIO 37 P 37-4101 TOP/1 AGANAGRAU KEIN E-TEIL	DAVIO 37 P 37-4101 TOP/1 AGANAGREY NO SPARE PART
0320.000	291104076502		TYPENAUFKLEBER VNX	TYPE LABEL VNX
	219779410501 720100407000 720100407400		BEDIENUNGSANLEITUNG D/I SERVICE MANUAL D/GB SERVICE MANUAL D/GB 4.ERGAENZUNG	OPERATING INSTRUCTIONS D/I SERVICE MANUAL D/GB SERVICE MANUAL D/GB 4TH SUPPLEMENT
	297040126500	X	CHASSIS-FS-MONO CUC 2103 INL KEIN E-TEIL	CHASSIS TV MONO CUC 2103 INL NO SPARE PART
			X=SIEHE GESONDERTE E-LISTE	X=SEE SEPARATE PARTS LIST
			ALLE WEITEREN TEILE SIEHE E-LISTE DAVIO 37 P 37-4101 TOP/1 AGANAGRAU MAT.-NR.: 921977230200 BESTELL-NR.: GCL6101 AUSGABE 1/2001 VERSION NR.: VNM SIEHE SERVICE MANUAL D/GB 1.ERG.	FOR ALL OTHER PARTS SEE DAVIO 37 P 37-4101 TOP/1 AGANAGREY PART NO: 921977230200 ORDER NR: GCL6101 EDITION 1/2001 VERSION NO.: VNM SEE SERVICE MANUAL D/GB 1TH SUPPL.
	720100407100			

Es gelten die Vorschriften und Sicherheitshinweise gemäß dem Service Manual "Sicherheit", Mat.-Nummer 720108000000, sowie zusätzlich die eventuell abweichenden, landesspezifischen Vorschriften!



The regulations and safety instructions shall be valid as provided by the "Safety" Service Manual, part number 720108000000, as well as the respective national deviations.

ÄNDERUNGEN VORBEHALTEN / SUBJECT TO ALTERATION

Ersatzteilliste
Spare Parts List

TV

12 / 2001

DAVIO 37 P 37-4101 MV

MATERIAL-NR. / PART NO.: 921977020200 BESTELL-NR. / ORDER NO.: GCL6400 AGANAGRAU/AGANAGREY
VERSION NR./VERSION NO.: VNX

POS. NR. ABB. POS. NO. FIG.	MATERIAL-NR. PART NUMBER	ANZ. QTY.	BEZEICHNUNG (D)	DESCRIPTION (GB)
	921977020200		DAVIO 37 P 37-4101 MV AGANAGRAU KEIN E-TEIL	DAVIO 37 P 37-4101 MV AGANAGREY NO SPARE PART
0320.000 2100.000	291104036503 829099131600		TYPENAUFKLEBER VNX NETZKABEL KPL	TYPE LABEL VNX POWER CABLE CPL
	219779410901 219779411001 219779411101 720100407000 720100407400		BEDIENUNGSANLEITUNG GB BEDIENUNGSANLEITUNG PL/CZ BEDIENUNGSANLEITUNG H/CIS SERVICE MANUAL D/GB SERVICE MANUAL D/GB 4.ERGAENZUNG	OPERATING INSTRUCTIONS GB OPERATING INSTRUCTIONS PL/CZ OPERATING INSTRUCTIONS H/CIS SERVICE MANUAL D/GB SERVICE MANUAL D/GB 4TH SUPPLEMENT
	297040126700	X	CHASSIS-FS-MONO CUC 2103 M KEIN E-TEIL	CHASSIS TV MONO CUC 2103 M NO SPARE PART
			X=SIEHE GESONDERTE E-LISTE	X=SEE SEPARATE PARTS LIST
			ALLE WEITEREN TEILE SIEHE E-LISTE DAVIO 37 P 37-4101 MV AGANAGRAU MAT.-NR.: 921977020200 BESTELL-NR.: GCL6400 AUSGABE 2/2001 VERSION NR.: VNM SIEHE SERVICE MANUAL D/GB 1.ERG.	FOR ALL OTHER PARTS SEE DAVIO 37 P 37-4101 MV AGANAGREY PART NO: 921977020200 ORDER NR: GCL6400 EDITION 2/2001 VERSION NO.: VNM SEE SERVICE MANUAL D/GB 1TH SUPPL.
	720100407100			

Es gelten die Vorschriften und Sicherheitshinweise gemäß dem Service Manual "Sicherheit", Mat.-Nummer 720108000000, sowie zusätzlich die eventuell abweichenden, landesspezifischen Vorschriften!



The regulations and safety instructions shall be valid as provided by the "Safety" Service Manual, part number 720108000000, as well as the respective national deviations.

ÄNDERUNGEN VORBEHALTEN / SUBJECT TO ALTERATION

GRUNDIGErsatzteilliste
Spare Parts List**TV****12 / 2001****DAVIO 37 P 37-4101 MV**MATERIAL-NR. / PART NO.: 921977024100 BESTELL-NR. / ORDER NO.: GCL6410 ICE BLUE
VERSION NR./VERSION NO.: VNX

POS. NR. POS. NO.	ABB. FIG.	MATERIAL-NR. PART NUMBER	ANZ. QTY.	BEZEICHNUNG (D)	DESCRIPTION (GB)
		921977024100		DAVIO 37 P 37-4101 MV ICE BLUE KEIN E-TEIL	DAVIO 37 P 37-4101 MV ICE BLUE NO SPARE PART
0320.000		291104036503		TYPENAUFKLEBER VNX	TYPE LABEL VNX
		219779410901 219779411001 219779411101 720100407000 720100407400		BEDIENUNGSANLEITUNG GB BEDIENUNGSANLEITUNG PL/CZ BEDIENUNGSANLEITUNG H/CIS SERVICE MANUAL D/GB SERVICE MANUAL D/GB 4.ERGAENZUNG	OPERATING INSTRUCTIONS GB OPERATING INSTRUCTIONS PL/CZ OPERATING INSTRUCTIONS H/CIS SERVICE MANUAL D/GB SERVICE MANUAL D/GB 4TH SUPPLEMENT
		297040126700	X	CHASSIS-FS-MONO CUC 2103 M KEIN E-TEIL	CHASSIS TV MONO CUC 2103 M NO SPARE PART
				X-SIEHE GESONDERTE E-LISTE	X=SEE SEPARATE PARTS LIST
				ALLE WEITEREN TEILE SIEHE E-LISTE DAVIO 37 P 37-4101 MV ICE BLUE MAT.-NR.: 921977024100 BESTELL-NR.: GCL6410 AUSGABE 12/2001 VERSION NR.: VNA	FOR ALL OTHER PARTS SEE DAVIO 37 P 37-4101 MV ICE BLUE PART NO: 921977024100 ORDER NR: GCL6410 EDITION 12/2001 VERSION NO.: VNA
		720100407500		SIEHE SERVICE MANUAL D/GB 5.ERG.	SEE SERVICE MANUAL D/GB 5TH SUPPL.

GRUNDIGErsatzteilliste
Spare Parts List**TV****12 / 2001****DAVIO 37 P 37-4101 MV**MATERIAL-NR. / PART NO.: 921977028900 BESTELL-NR. / ORDER NO.: GCL6420 CORONA SILBER/CORONA SILVER
VERSION NR./VERSION NO.: VNX

POS. NR. POS. NO.	ABB. FIG.	MATERIAL-NR. PART NUMBER	ANZ. QTY.	BEZEICHNUNG (D)	DESCRIPTION (GB)
		921977028900		DAVIO 37 P 37-4101 MV CORONA SILBER KEIN E-TEIL	DAVIO 37 P 37-4101 MV CORONA SILVER NO SPARE PART
0200.000 0320.000		296352291700 291104036503		GEH-VORDERTEIL KPL TYPENAUFKLEBER VNX	CABINET FRONT PART CPL TYPE LABEL VNX
2400.000 2410.000		296420621800 267280080001		TP 750 C FERNBEDIENUNG SCHWARZ DECKEL BATTERIE TP 750 C	TP 750 C REMOTE CONTROL BLACK BATTERY LID TP 750 C
		219779410901 219779411001 219779411101 720100407000 720100407400		BEDIENUNGSANLEITUNG GB BEDIENUNGSANLEITUNG PL/CZ BEDIENUNGSANLEITUNG H/CIS SERVICE MANUAL D/GB SERVICE MANUAL D/GB 4.ERGAENZUNG	OPERATING INSTRUCTIONS GB OPERATING INSTRUCTIONS PL/CZ OPERATING INSTRUCTIONS H/CIS SERVICE MANUAL D/GB SERVICE MANUAL D/GB 4TH SUPPLEMENT
		297040126700	X	CHASSIS-FS-MONO CUC 2103 M KEIN E-TEIL	CHASSIS TV MONO CUC 2103 M NO SPARE PART
				X-SIEHE GESONDERTE E-LISTE	X=SEE SEPARATE PARTS LIST
				ALLE WEITEREN TEILE SIEHE E-LISTE DAVIO 37 P 37-4101 MV CORONA SILBER MAT.-NR.: 921977028900 BESTELL-NR.: GCL6420 AUSGABE 4/2001 VERSION NR.: VNA	FOR ALL OTHER PARTS SEE DAVIO 37 P 37-4101 MV CORONA SILVER PART NO: 921977028900 ORDER NR: GCL6420 EDITION 4/2001 VERSION NO.: VNA
		720100407500		SIEHE SERVICE MANUAL D/GB 5.ERG.	SEE SERVICE MANUAL D/GB 5TH SUPPL.

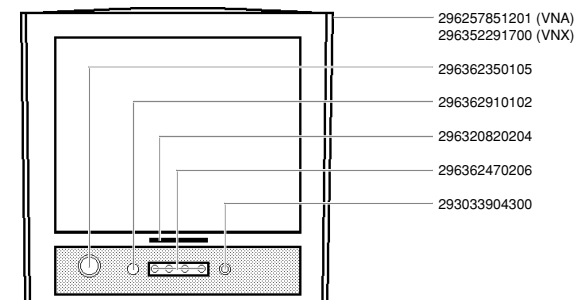

Es gelten die Vorschriften und Sicherheitshinweise gemäß dem Service Manual "Sicherheit", Mat.-Nummer 720108000000, sowie zusätzlich die eventuell abweichenden, landesspezifischen Vorschriften!



The regulations and safety instructions shall be valid as provided by the "Safety" Service Manual, part number 720108000000, as well as the respective national deviations.

ÄNDERUNGEN VORBEHALTEN / SUBJECT TO ALTERATION

Es gelten die Vorschriften und Sicherheitshinweise gemäß dem Service Manual "Sicherheit", Mat.-Nummer 720108000000, sowie zusätzlich die eventuell abweichenden, landesspezifischen Vorschriften!



The regulations and safety instructions shall be valid as provided by the "Safety" Service Manual, part number 720108000000, as well as the respective national deviations.

ÄNDERUNGEN VORBEHALTEN / SUBJECT TO ALTERATION

Ersatzteilliste
Spare Parts List

TV

3 / 2002

DAVIO 37 P 37-4101/12 MV

MATERIAL-NR. / PART NO.: 921936028900 BESTELL-NR. / ORDER NO.: GCL3500 CORONA SILBER/CORONA SILVER
VERSION NR./VERSION NO.: VNA

POS. NR. POS. NO.	ABB. FIG.	MATERIAL-NR. PART NUMBER	ANZ. QTY.	BEZEICHNUNG (D)	DESCRIPTION (GB)
		921936028900		DAVIO 37 P 37-4101/12 MV CORONA SILBER KEIN E-TEIL	DAVIO 37 P 37-4101/12 MV CORONA SILVER NO SPARE PART
0320.000 2100.000 2400.000 2410.000	△	291104196403 829099131600 296420621800 267280080001		TYPENAUFKLEBER VNA NETZKABEL KPL TP 750 C FERNBEDIENUNG SCHWARZ DECKEL BATTERIE TP 750 C	TYPE LABEL VNA POWER CABLE CPL TP 750 C REMOTE CONTROL BLACK BATTERY LID TP 750 C
		219369410300 219369410400 720100407000 720100407400		BEDIENUNGSANLEITUNG D/GB/F/INL BEDIENUNGSANLEITUNG N/S/FIN/E/P SERVICE MANUAL D/GB SERVICE MANUAL D/GB 4.ERGAENZUNG	OPERATING INSTRUCTIONS D/GB/F/INL OPERATING INSTRUCTIONS N/S/FIN/E/P SERVICE MANUAL D/GB SERVICE MANUAL D/GB 4TH SUPPLEMENT
		297040125900	X	CHASSIS-FS-MONO CUC 2105 M/BAT KEIN E-TEIL X=SIEHE GESONDERTE E-LISTE	CHASSIS TV MONO CUC 2105 M/BAT NO SPARE PART X=SEE SEPARATE PARTS LIST
		720100407300		ALLE WEITEREN TEILE SIEHE E-LISTE DAVIO 37 P 37-4101/12 MV CORONA SILBER MAT.-NR.: 921936028900 BESTELL-NR.: GCL3500 AUSGABE 5/2001 VERSION NR.: VNM SIEHE SERVICE MANUAL D/GB 3.ERG.	FOR ALL OTHER PARTS SEE DAVIO 37 P 37-4101/12 MV CORONA SILVER PART NO: 921936028900 ORDER NR: GCL3500 EDITION 5/2001 VERSION NO.: VNM SEE SERVICE MANUAL D/GB 3TH SUPPL.

Es gelten die Vorschriften und Sicherheitshinweise gemäß dem Service Manual "Sicherheit", Mat.-Nummer 720108000000, sowie zusätzlich die eventuell abweichenden, landesspezifischen Vorschriften!



The regulations and safety instructions shall be valid as provided by the "Safety" Service Manual, part number 720108000000, as well as the respective national deviations.

ÄNDERUNGEN VORBEHALTEN / SUBJECT TO ALTERATION

Ersatzteilliste
Spare Parts List

TV

3 / 2002

DAVIO 37 P 37-4101/12 MV/SAT

MATERIAL-NR. / PART NO.: 921936228900 BESTELL-NR. / ORDER NO.: GCM1800 CORONA SILBER/CORONA SILVER
VERSION NR./VERSION NO.: VNA

POS. NR. POS. NO.	ABB. FIG.	MATERIAL-NR. PART NUMBER	ANZ. QTY.	BEZEICHNUNG (D)	DESCRIPTION (GB)
		921936228900		DAVIO 37 P 37-4101/12 MV/SAT CORONA SILBER KEIN E-TEIL	DAVIO 37 P 37-4101/12 MV/SAT CORONA SILVER NO SPARE PART
0320.000 2100.000 2400.000 2410.000	△	291104186403 829099131600 296420621800 267280080001		TYPENAUFKLEBER VNA NETZKABEL KPL TP 750 C FERNBEDIENUNG SCHWARZ DECKEL BATTERIE TP 750 C	TYPE LABEL VNA POWER CABLE CPL TP 750 C REMOTE CONTROL BLACK BATTERY LID TP 750 C
		219369410200 720100407000 720100407400		BEDIENUNGSANLEITUNG D/I SERVICE MANUAL D/GB SERVICE MANUAL D/GB 4.ERGAENZUNG	OPERATING INSTRUCTIONS D/I SERVICE MANUAL D/GB SERVICE MANUAL D/GB 4TH SUPPLEMENT
		297040126000	X	CHASSIS-FS-MONO CUC 2105 M/BAT/SAT KEIN E-TEIL X=SIEHE GESONDERTE E-LISTE	CHASSIS TV MONO CUC 2105 M/BAT/SAT NO SPARE PART X=SEE SEPARATE PARTS LIST
		720100407300		ALLE WEITEREN TEILE SIEHE E-LISTE DAVIO 37 P 37-4101/12 MV/SAT CORONA SILBER MAT.-NR.: 921936228900 BESTELL-NR.: GCM1800 AUSGABE 5/2001 VERSION NR.: VNM SIEHE SERVICE MANUAL D/GB 3.ERG.	FOR ALL OTHER PARTS SEE DAVIO 37 P 37-4101/12 MV/SAT CORONA SILVER PART NO: 921936228900 ORDER NR: GCM1800 EDITION 5/2001 VERSION NO.: VNM SEE SERVICE MANUAL D/GB 3TH SUPPL.

Es gelten die Vorschriften und Sicherheitshinweise gemäß dem Service Manual "Sicherheit", Mat.-Nummer 720108000000, sowie zusätzlich die eventuell abweichenden, landesspezifischen Vorschriften!



The regulations and safety instructions shall be valid as provided by the "Safety" Service Manual, part number 720108000000, as well as the respective national deviations.

ÄNDERUNGEN VORBEHALTEN / SUBJECT TO ALTERATION

Ersatzteilliste
Spare Parts List**GRUNDIG****TV****2 / 2001****XENTIA 55 ST 55-405 DOLBY**MATERIAL-NR. / PART NO.: 921964014000 BESTELL-NR. / ORDER NO.: GCL7100 PROCON SILBER/PROCON SILVER
VERSION NR./VERSION NO.: VNA

POS. NR. POS. NO.	ABB. FIG.	MATERIAL-NR. PART NUMBER	ANZ. QTY.	BEZEICHNUNG (D)	DESCRIPTION (GB)
		921964014000		XENTIA 55 ST 55-405 DOLBY PROCON SILBER KEIN E-TEIL	XENTIA 55 ST 55-405 DOLBY PROCON SILVER NO SPARE PART
0210.000		296383190101		ZIERLEISTE KPL	ORNAMENTAL STRIP CPL
WW.		759550275700		ZIERLEISTE KPL BLAU	ORNAMENTAL STRIP CPL BLUE
WW.		759550275800		ZIERLEISTE KPL HOLZ DUNKEL	ORNAMENTAL STRIP CPL WOOD DARK
WW.		759550275900		ZIERLEISTE KPL HELL GRUEN	ORNAMENTAL STRIP CPL LIGHT GREEN
WW.		759550276000		ZIERLEISTE KPL ORANGE	ORNAMENTAL STRIP CPL ORANGE
0240.000		293033904200		KOPFHUERERBUCHSE 3,5 O.SCHALTER	HEADPHONE SOCKET 3,5 W/O SWITCH
0241.000		293031680503		CINCH-BUCHSE 3-FACH FBAS/NF L,R	CINCH SOCKET 3 FOLD FBAS/AF L,R
0312.000		297006430104		ABDECKUNG EURO-AV	COVER EURO AV
0320.000		291103096404		TYPENAUFKLEBER VNA	TYPE LABEL VNA
2400.000		296420621900		TP 750 C FERNBEDIENUNG GRAU	TP 750 C REMOTE CONTROL GREY
2410.000		720086738000		DECKEL BATTERIE TP 750 C	BATTERY LID TP 750 C
		219649410100		BEDIENUNGSANLEITUNG D/I	OPERATING INSTRUCTIONS D/I
		720100407000		SERVICE MANUAL D/GB	SERVICE MANUAL D/GB
		720100407400		SERVICE MANUAL D/GB 4.ERGAENZUNG	SERVICE MANUAL D/GB 4TH SUPPLEMENT
		297040135400	X	CHASSIS-FS-STEREO PHILIPS-BR CUC 2121 INL/DOLBY KEIN E-TEIL	CHASSIS TV STEREO PHILIPS PT CUC 2121 INL/DOLBY NO SPARE PART
		297040135500	X	CHASSIS-FS-STEREO VIDEOCOLOR-BR CUC 2121 INL/DOLBY KEIN E-TEIL	CHASSIS TV STEREO VIDEOCOLOR PT CUC 2121 INL/DOLBY NO SPARE PART
		297040135600	X	CHASSIS-FS-STEREO SAMSUNG-BR CUC 2121 INL/DOLBY KEIN E-TEIL	CHASSIS TV STEREO SAMSUNG PT CUC 2121 INL/DOLBY NO SPARE PART
				WW.=WAHLWEISE X=SIEHE GESONDERTE E-LISTE	WW.=OPTIONAL X=SEE SEPARATE PARTS LIST
				ALLE WEITEREN TEILE SIEHE E-LISTE XENTIA 55 ST 55-405 DOLBY PROCON SILBER MAT.-NR.: 921964014000 BESTELL-NR.: GCL7100 AUSGABE 9/2001 VERSION NR.: VNM SIEHE SERVICE MANUAL D/GB 2.ERG.	FOR ALL OTHER PARTS SEE XENTIA 55 ST 55-405 DOLBY PROCON SILVER PART NO.: 921964014000 ORDER NR.: GCL7100 EDITION 9/2001 VERSION NO.: VNM SEE SERVICE MANUAL D/GB 2TH SUPPL.
		720100407200			

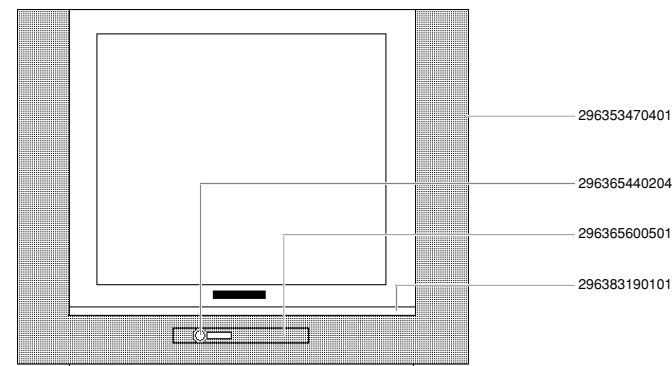
XENTIA 55 ST 55-405 DOLBYPOS. NR. MATERIAL-NR. BEZEICHNUNG
POS. NO. PART NUMBER DESCRIPTIONPOS. NR. MATERIAL-NR. BEZEICHNUNG
POS. NO. PART NUMBER DESCRIPTIONEs gelten die Vorschriften und Sicherheitshinweise
gemäß dem Service Manual "Sicherheit", Mat.-Num-
mer 720108000000, sowie zusätzlich die eventuell ab-
weichenden, landesspezifischen Vorschriften!The regulations and safety instructions shall be valid
as provided by the "Safety" Service Manual, part
number 720108000000, as well as the respective
national deviations.

ÄNDERUNGEN VORBEHALTEN / SUBJECT TO ALTERATION

ÄNDERUNGEN VORBEHALTEN / SUBJECT TO ALTERATION

Ersatzteilliste Spare Parts List

GRUNDIG

TV

2 / 2001

XENTIA 55 ST 55-405 DOLBY

MATERIAL-NR. / PART NO.: 921964017700 BESTELL-NR. / ORDER NO.: GCL7177 ELON METALLIC/ELON METALLIC
VERSION NR./VERSION NO.: VNA

POS. NR. POS. NO.	ABB. FIG.	MATERIAL-NR. PART NUMBER	ANZ. QTY.	BEZEICHNUNG (D)	DESCRIPTION (GB)
		921964017700		XENTIA 55 ST 55-405 DOLBY ELON METALLIC KEIN E-TEIL	XENTIA 55 ST 55-405 DOLBY ELON METALLIC NO SPARE PART
0240.000		293033904200		KOPFHOERERBUCHSE 3,5 O.SCHALTER	HEADPHONE SOCKET 3,5 W/O SWITCH
0241.000		293031680503		CINCH-BUCHSE 3-FACH FBAS/NF L,R	CINCH SOCKET 3 FOLD FBAS/AF L,R
0312.000		297006430104		ABDECKUNG EURO-AV	COVER EURO AV
0320.000		291103096404		TYPENAUFKLEBER VNA	TYPE LABEL VNA
0700.000	△	092461287510		ENTMAGNETISIERUNGSSPULE M.HALTER	COIL DEGAUSSING W.HOLDER
1100.000	△	830002065500		BILDR.A51EAL155X01 PHILIPS	PIC.TUBE A51EAL155X01 PHILIPS
1100.000	△	830002058300		BILDR.A51EFS83X191 VIDEOCOLOR	PIC.TUBE A51EFS83X191 VIDEOCOLOR
1100.000	△	830002051300		BILDR.A51EER33X78 SAMSUNG	PIC.TUBE A51EER33X78 SAMSUNG
2400.000		296420621900		TP 750 C FERNBEDIENUNG GRAU	TP 750 C REMOTE CONTROL GREY
2410.000		720086738000		DECKEL BATTERIE TP 750 C	BATTERY LID TP 750 C
		219649410100		BEDIENUNGSANLEITUNG D/I	OPERATING INSTRUCTIONS D/I
		720100407000		SERVICE MANUAL D/GB	SERVICE MANUAL D/GB
		720100407400		SERVICE MANUAL D/GB 4.ERGAENZUNG	SERVICE MANUAL D/GB 4TH SUPPLEMENT
		297040135400	X	CHASSIS-FS-STEREO PHILIPS-BR CUC 2121 INL/DOLBY KEIN E-TEIL	CHASSIS TV STEREO PHILIPS PT CUC 2121 INL/DOLBY NO SPARE PART
		297040135500	X	CHASSIS-FS-STEREO VIDEOCOLOR-BR CUC 2121 INL/DOLBY KEIN E-TEIL	CHASSIS TV STEREO VIDEOCOLOR PT CUC 2121 INL/DOLBY NO SPARE PART
		297040135600	X	CHASSIS-FS-STEREO SAMSUNG-BR CUC 2121 INL/DOLBY KEIN E-TEIL	CHASSIS TV STEREO SAMSUNG PT CUC 2121 INL/DOLBY NO SPARE PART
				X=SIEHE GESONDERTE E-LISTE	X=SEE SEPARATE PARTS LIST
				ALLE WEITEREN TEILE SIEHE E-LISTE XENTIA 55 ST 55-405 DOLBY ELON METALLIC BESTELL-NR.: GCL7177 AUSGABE 11/2000 VERSION NR.: VNM	FOR ALL OTHER PARTS SEE XENTIA 55 ST 55-405 DOLBY ELON METALLIC ORDER NR: GCL7177 EDITION 11/2000 VERSION NO.: VNM
		720100407200		SIEHE SERVICE MANUAL D/GB 2.ERG.	SEE SERVICE MANUAL D/GB 2TH SUPPL.

ÄNDERUNGEN VORBEHALTEN / SUBJECT TO ALTERATION

POS. NR. MATERIAL-NR. BEZEICHNUNG
POS. NO. PART NUMBER DESCRIPTION

POS. NR. MATERIAL-NR. BEZEICHNUNG
POS. NO. PART NUMBER DESCRIPTION

XENTIA 55 ST 55-405 DOLBY

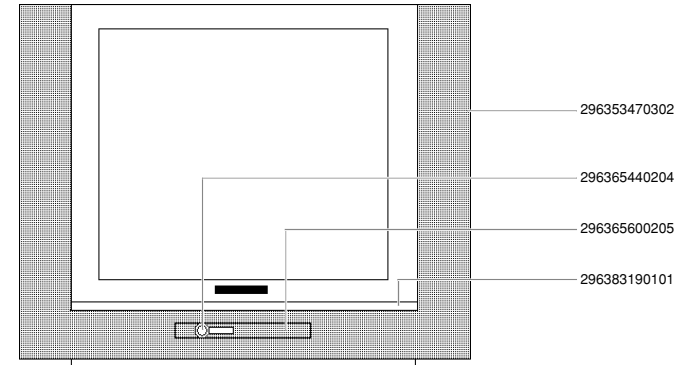

Es gelten die Vorschriften und Sicherheitshinweise gemäß dem Service Manual "Sicherheit", Mat.-Nummer 720108000000, sowie zusätzlich die eventuell abweichenden, landesspezifischen Vorschriften!



The regulations and safety instructions shall be valid as provided by the "Safety" Service Manual, part number 720108000000, as well as the respective national deviations.

ÄNDERUNGEN VORBEHALTEN / SUBJECT TO ALTERATION

Ersatzteilliste
Spare Parts List**GRUNDIG****TV****11 / 2001****DAVIO 55 ST 55-854 DOLBY**MATERIAL-NR. / PART NO.: 921931017200 BESTELL-NR. / ORDER NO.: GCL3072 AGANA-GRAU/AGANA GREY
VERSION NR./VERSION NO.: VNA

POS. NR. POS. NO.	ABB. FIG.	MATERIAL-NR. PART NUMBER	ANZ. QTY.	BEZEICHNUNG (D)	DESCRIPTION (GB)
		921931017200		DAVIO 55 ST 55-854 DOLBY AGANA-GRAU KEIN E-TEIL	DAVIO 55 ST 55-854 DOLBY AGANA GREY NO SPARE PART
0218.000		295016880207		NETZTASTENKNOPF	KNOB KEY POWER
0240.000		293033904200		KOPFHOERERBUCHSE 3,5 O.SCHALTER	HEADPHONE SOCKET 3.5 W/O SWITCH
0241.000		293031680503		CINCH-BUCHSE 3-FACH FBAS/NF L,R	CINCH SOCKET 3 FOLD FBAS/AF L,R
0300.000		296362630101		GEH-RUECKTEIL OFB	CABINET REAR PART SURFACE TREATED
0310.000		296381040301		LS-BOX 16 OHM LINKS KPL	SPEAKER 16 OHM LEFT CPL
0310.000		296381050301		LS-BOX 16 OHM RECHTS KPL	SPEAKER 16 OHM RIGHT CPL
0312.000		297006430104		ABDECKUNG EURO-AV	COVER EURO AV
0320.000		291102196402		TYPENAUFKLEBER VNA	TYPE LABEL VNA
0700.000	△	092461287510		ENTMAGNETISIERUNGSSPULE M.HALTER	COIL DEGAUSSING W.HOLDER
1100.000	△	830002065500		BILDR.A51EAL155X01 PHILIPS	PIC.TUBE A51EAL155X01 PHILIPS
1100.000	△	830002058300		BILDR.A51EFS 83X191 VIDEOCOLOR	PIC.TUBE A51EFS 83X191 VIDEOCOLOR
1100.000	△	830002051300		BILDR.A51EER 33X78 SAMSUNG	PIC.TUBE A51EER 33X78 SAMSUNG
2400.000		296420621800		TP 750 C FERNBEDIENUNG SCHWARZ	TP 750 C REMOTE CONTROL BLACK
2410.000		267280080001		DECKEL BATTERIE TP 750 C	BATTERY LID TP 750 C
		219319410800		BEDIENUNGSANLEITUNG D/F/I/NL	OPERATING INSTRUCTIONS D/F/I/NL
		720100407000		SERVICE MANUAL D/GB	SERVICE MANUAL D/GB
		720100407400		SERVICE MANUAL D/GB 4.ERGAENZUNG	SERVICE MANUAL D/GB 4TH SUPPLEMENT
		297040135400	X	CHASSIS-FS-STEREO PHILIPS-BR CUC 2121 INL/DOLBY KEIN E-TEIL	CHASSIS TV STEREO PHILIPS PT CUC 2121 INL/DOLBY NO SPARE PART
		297040135500	X	CHASSIS-FS-STEREO VIDEOCOLOR-BR CUC 2121 INL/DOLBY KEIN E-TEIL	CHASSIS TV STEREO VIDEOCOLOR PT CUC 2121 INL/DOLBY NO SPARE PART
		297040135600	X	CHASSIS-FS-STEREO SAMSUNG-BR CUC 2121 INL/DOLBY KEIN E-TEIL	CHASSIS TV STEREO SAMSUNG PT CUC 2121 INL/DOLBY NO SPARE PART
				X=SIEHGE GESONDERTE E-LISTE	X=SEE SEPARATE PARTS LIST
				ALLE WEITEREN TEILE SIEHE E-LISTE DAVIO 55 ST 55-854 DOLBY AGANA-GRAU MAT.-NR.: 921931017200 BESTELL-NR.: GCL3072 AUSGABE 11/2000 VERSION NR.: VNM SIEHE SERVICE MANUAL	FOR ALL OTHER PARTS SEE DAVIO 55 ST 55-854 DOLBY AGANA GREY PART NO.: 921931017200 ORDER NR.: GCL3072 EDITION 11/2000 VERSION NO.: VNM SEE SERVICE MANUAL D/GB
		720100407000			

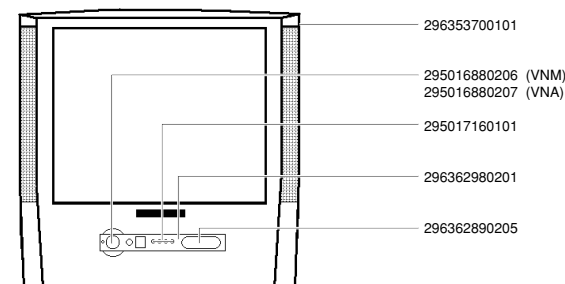
DAVIO 55 ST 55-854 DOLBYPOS. NR. MATERIAL-NR. BEZEICHNUNG
POS. NO. PART NUMBER DESCRIPTIONPOS. NR. MATERIAL-NR. BEZEICHNUNG
POS. NO. PART NUMBER DESCRIPTIONEs gelten die Vorschriften und Sicherheitshinweise
gemäß dem Service Manual "Sicherheit", Mat.-Num-
mer 720108000000, sowie zusätzlich die eventuell ab-
weichenden, landesspezifischen Vorschriften!The regulations and safety instructions shall be valid
as provided by the "Safety" Service Manual, part
number 720108000000, as well as the respective
national deviations.

ÄNDERUNGEN VORBEHALTEN / SUBJECT TO ALTERATION

ÄNDERUNGEN VORBEHALTEN / SUBJECT TO ALTERATION

Ersatzteilliste
Spare Parts List

TV

11 / 2001

DAVIO 55 ST 55-854 DOLBY

MATERIAL-NR. / PART NO.: 921931018900 BESTELL-NR. / ORDER NO.: GCL3000 CORONA SILBER/CORONA SILVER
VERSION NR./VERSION NO.: VNA

POS. NR. POS. NO.	ABB. FIG.	MATERIAL-NR. PART NUMBER	ANZ. QTY.	BEZEICHNUNG (D)	DESCRIPTION (GB)
		921931018900		DAVIO 55 ST 55-854 DOLBY CORONA SILBER KEIN E-TEIL	DAVIO 55 ST 55-854 DOLBY CORONA SILVER NO SPARE PART
0320.000		291102196402		TYPENAUFKLEBER VNA	TYPE LABEL VNA
		219319410800 720100407000 720100407400		BEDIENUNGSANLEITUNG D/F//NL SERVICE MANUAL D/GB SERVICE MANUAL D/GB 4.ERGAENZUNG	OPERATING INSTRUCTIONS D/F//NL SERVICE MANUAL D/GB SERVICE MANUAL D/GB 4TH SUPPLEMENT
		297040135400	X	CHASSIS-FS-STEREO PHILIPS-BR CUC 2121 INL/DOLBY KEIN E-TEIL	CHASSIS TV STEREO PHILIPS PT CUC 2121 INL/DOLBY NO SPARE PART
		297040135500	X	CHASSIS-FS-STEREO VIDEOCOLOR-BR CUC 2121 INL/DOLBY KEIN E-TEIL	CHASSIS TV STEREO VIDEOCOLOR PT CUC 2121 INL/DOLBY NO SPARE PART
		297040135600	X	CHASSIS-FS-STEREO SAMSUNG-BR CUC 2121 INL/DOLBY KEIN E-TEIL	CHASSIS TV STEREO SAMSUNG PT CUC 2121 INL/DOLBY NO SPARE PART
				X=SIEHE GESONDERTE E-LISTE	X=SEE SEPARATE PARTS LIST
				ALLE WEITEREN TEILE SIEHE E-LISTE DAVIO 55 ST 55-854 DOLBY CORONA SILBER MAT.-NR.: 921931018900 BESTELL-NR.: GCL3000 AUSGABE 11/2001 VERSION NR.: VNM	FOR ALL OTHER PARTS SEE DAVIO 55 ST 55-854 DOLBY CORONA SILVER PART NO.: 921931018900 ORDER NO.: GCL3000 EDITION 11/2001 VERSION NO.: VNM
		720100407000		SIEHE SERVICE MANUAL D/GB	SEE SERVICE MANUAL D/GB

Es gelten die Vorschriften und Sicherheitshinweise gemäß dem Service Manual "Sicherheit", Mat.-Nummer 720108000000, sowie zusätzlich die eventuell abweichenden, landesspezifischen Vorschriften!



The regulations and safety instructions shall be valid as provided by the "Safety" Service Manual, part number 720108000000, as well as the respective national deviations.

ÄNDERUNGEN VORBEHALTEN / SUBJECT TO ALTERATION

Ersatzteilliste
Spare Parts List

TV

2 / 2002

ST 55-908 DOLBY

MATERIAL-NR. / PART NO.: 921965017500 BESTELL-NR. / ORDER NO.: GCM4200 SCHWARZ/BLACK
VERSION NR./VERSION NO.: VNA

POS. NR. POS. NO.	ABB. FIG.	MATERIAL-NR. PART NUMBER	ANZ. QTY.	BEZEICHNUNG (D)	DESCRIPTION (GB)
		921965017500		ST 55-908 DOLBY SCHWARZ KEIN E-TEIL	ST 55-908 DOLBY BLACK NO SPARE PART
0320.000 0700.000	△	291103746402 092461287510		TYPENAUFKLEBER VNA ENTMAGNETISIERUNGSSPULE	TYPE LABEL SELF ADHESIVE VNA COIL DEGAUSSING
		219659411500 219659411600 720100407000 720100407400		BEDIENUNGSANLEITUNG D//GB BEDIENUNGSANLEITUNG NL/GR SERVICE MANUAL D/GB SERVICE MANUAL D/GB 4.ERGAENZUNG	OPERATING INSTRUCTIONS D//GB OPERATING INSTRUCTIONS NL/GR SERVICE MANUAL D/GB SERVICE MANUAL D/GB 4TH SUPPLEMENT
		297040136600	X	CHASSIS-FS-STEREO CUC 2121 INL DOLBY KEIN E-TEIL FUER BR A51EAL155X01	CHASSIS TV STEREO CUC 2121 INL DOLBY NO SPARE PART FOR PT A51EAL155X01
		297040136700	X	CHASSIS-FS-STEREO CUC 2121 INL DOLBY KEIN E-TEIL FUER BR A51EFS83X191	CHASSIS TV STEREO CUC 2121 INL DOLBY NO SPARE PART FOR PT A51EFS83X191
		297040136800	X	CHASSIS-FS-STEREO CUC 2121 INL DOLBY KEIN E-TEIL FUER BR A51EER33X78	CHASSIS TV STEREO CUC 2121 INL DOLBY NO SPARE PART FOR PT A51EER33X78
				X = SIEHE GESONDERTE E-LISTE	X = SEE SEPARATE PARTS LIST
				ALLE WEITEREN TEILE SIEHE E-LISTE ST 55-908 DOLBY MAT.-NR.: 921965017500 BESTELL-NR.: GCM4200 AUSGABE 11/2000 VERSION NR.: VNM	FOR ALL OTHER PARTS SEE ST 55-908 DOLBY PART NO.: 921965017500 ORDER NO.: GCM4200 EDITION 11/2000 VERSION NO.: VNM
		720100407000		SIEHE SERVICE MANUAL	SEE SERVICE MANUAL D/GB

Es gelten die Vorschriften und Sicherheitshinweise gemäß dem Service Manual "Sicherheit", Mat.-Nummer 720108000000, sowie zusätzlich die eventuell abweichenden, landesspezifischen Vorschriften!



The regulations and safety instructions shall be valid as provided by the "Safety" Service Manual, part number 720108000000, as well as the respective national deviations.

ÄNDERUNGEN VORBEHALTEN / SUBJECT TO ALTERATION

GRUNDIG

Ersatzteilliste
Spare Parts List

TV

2 / 2002

ST 55-998 DOLBY

MATERIAL-NR. / PART NO.: 921982017200 BESTELL-NR. / ORDER NO.: GCM3100 AGANA-GRAU /AGANA GREY
VERSION NR./VERSION NO.: VNA

POS. NR. ABB. POS. NO. FIG.	MATERIAL-NR. PART NUMBER	ANZ. QTY.	BEZEICHNUNG (D)	DESCRIPTION (GB)
	921982017200		ST 55-998 DOLBY AGANA-GRAU KEIN E-TEIL	ST 55-998 DOLBY AGANA GREY NO SPARE PART
0218.000	295016880207		NETZTASTENKNOPF	KNOB KEY POWER
0240.000	293033904200		KOPFHÖRERBUCHSE 3,5 O.SCHALTER	HEADPHONE SOCKET 3,5 W/O SWITCH
0241.000	293031680503		CINCH-BUCHSE 3-FACH FBAS/NF L,R	CINCH SOCKET 3 FOLD FBAS/AF L,R
0312.000	297006430104		ABDECKUNG EURO-AV	COVER EURO AV
0320.000	291103676402		TYPENAUFKLEBER VNA	TYPE LABEL VNA
0700.000	092461287510		ENTMAGNETISIERUNGSSPULE M.HALTER	COIL DEGAUSSING W.HOLDER
2400.000	296420621900		TP 750 C FERNBEDIENUNG GRAU	TP 750 C REMOTE CONTROL GREY
2410.000	720086738000		DECKEL BATTERIE TP 750 C	BATTERY LID TP 750 C
	219829410100		BEDIENUNGSANLEITUNG D	OPERATING INSTRUCTIONS D
	720100407000		SERVICE MANUAL D/GB	SERVICE MANUAL D/GB
	720100407400		SERVICE MANUAL D/GB 4.ERGAENZUNG	SERVICE MANUAL D/GB 4TH SUPPLEMENT
	297040135400	X	CHASSIS-FS-STEREO CUC 2121 INL/DOLBY KEIN E-TEIL	CHASSIS TV STEREO CUC 2121 INL/DOLBY NO SPARE PART
			X=SIEHGE GESONDERTE E-LISTE	X=SEE SEPARATE PARTS LIST
			ALLE WEITEREN TEILE SIEHE E-LISTE ST 55-998 DOLBY AGANA-GRAU MAT.-NR.: 921982017200 BESTELL-NR.: GCM3100 AUSGABE 11/2000 VERSION NR. VNM SIEHE SERVICE MANUAL D/GB	FOR ALL OTHER PARTS SEE ST 55-998 DOLBY AGANA GREY PART NO.: 921982017200 ORDER NR: GCM3100 EDITION 11/2000 VERSION NO VNM SEE SERVICE MANUAL D/GB
	720100407000			

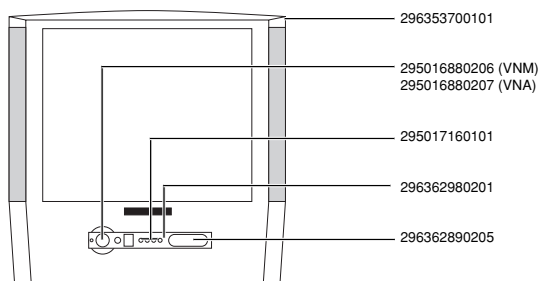

Es gelten die Vorschriften und Sicherheitshinweise gemäß dem Service Manual "Sicherheit", Mat.-Nummer 720108000000, sowie zusätzlich die eventuell abweichenden, landesspezifischen Vorschriften!



The regulations and safety instructions shall be valid as provided by the "Safety" Service Manual, part number 720108000000, as well as the respective national deviations.

ÄNDERUNGEN VORBEHALTEN / SUBJECT TO ALTERATION

GRUNDIG

Ersatzteilliste
Spare Parts List

TV

3 / 2002

LEEMAXX 55 ST 55-4105 DOLBY

MATERIAL-NR. / PART NO.: 921981018900 BESTELL-NR. / ORDER NO.: GCM1700 CORONA SILBER /CORONA SILVER
VERSION NR./VERSION NO.: VNA

POS. NR. ABB. POS. NO. FIG.	MATERIAL-NR. PART NUMBER	ANZ. QTY.	BEZEICHNUNG (D)	DESCRIPTION (GB)
	921981018900		LEEMAXX 55 ST 55-4105 DOLBY CORONA SILBER KEIN E-TEIL	LEEMAXX 55 ST 55-4105 DOLBY CORONA SILVER NO SPARE PART
0218.000	295017780102		TASTENKNOPF NETZSCHALTER	KEY KNOB MAINS SWITCH
0225.000	296366430104		KLAPPE	FLAP
0300.000	296366278905		GEH-RUECKTEIL	CABINET REAR PART
0311.000	297006220102	2	MONTAGE-FEDER LAUTSPRECHER	ASSEMBLY SPRING LOUDSPEAKER
0320.000	291103786402		TYPENAUFKLEBER VNA	TYPE LABEL SELF ADHESIVE VNA
0700.000	092461287510		ENTMAGNETISIERUNGSSPULE	COIL DEGAUSSING
2400.000	296420621800		TP 750 C FERNBEDIENUNG	TP 750 C REMOTE CONTROL
	219819410300		BEDIENUNGSANLEITUNG D/NL	OPERATION INSTRUCTIONS D/NL
	219819410400		BEDIENUNGSANLEITUNG E/P	OPERATION INSTRUCTIONS E/P
	720100407000		SERVICE MANUAL D/GB	SERVICE MANUAL D/GB
	720100407200		SERVICE MANUAL D/GB 2.ERGAENZUNG	SERVICE MANUAL D/GB 2ND SUPPLEMENT
	720100407400		SERVICE MANUAL D/GB 4.ERGAENZUNG	SERVICE MANUAL D/GB 4TH SUPPLEMENT
	297040135900	X	CHASSIS-FS-STEREO CUC 2121 INL DOLBY KEIN E-TEIL FUER BR A51EAL155X01	CHASSIS TV STEREO CUC 2121 INL DOLBY NO SPARE PART FOR PT A51EAL155X01
	297040136000	X	CHASSIS-FS-STEREO CUC 2121 INL DOLBY KEIN E-TEIL FUER BR A51EFS83X191	CHASSIS TV STEREO CUC 2121 INL DOLBY NO SPARE PART FOR PT A51EFS83X191
	297040136100	X	CHASSIS-FS-STEREO CUC 2121 INL DOLBY KEIN E-TEIL FUER BR A51EER33X78	CHASSIS TV STEREO CUC 2121 INL DOLBY NO SPARE PART FOR PT A51EER33X78
			X = SIEHE GESONDERTE E-LISTE	X = SEE SEPARATE PARTS LIST
			ALLE WEITEREN TEILE SIEHE E-LISTE LEEMAXX 55 ST 55-4105 DOLBY MAT.-NR.: 921981018900 BESTELL-NR.: GCM1700 AUSGABE 3/2001 VERSION NR.: VNM SIEHE SERVICE MANUAL D/GB 2.ERG.	FOR ALL OTHER PARTS SEE LEEMAXX 55 ST 55-4105 DOLBY PART NO.: 921981018900 ORDER NO.: GCM1700 EDITION 3/2001 VERSION NO.: VNM SEE SERVICE MANUAL D/GB 2TH SUPPL.
	720100407200			

ÄNDERUNGEN VORBEHALTEN / SUBJECT TO ALTERATION

POS. NR. MATERIAL-NR. BEZEICHNUNG
POS. NO. PART NUMBER DESCRIPTION

POS. NR. MATERIAL-NR. BEZEICHNUNG
POS. NO. PART NUMBER DESCRIPTION

LEEMAXX 55 ST 55-4105 DOLBY

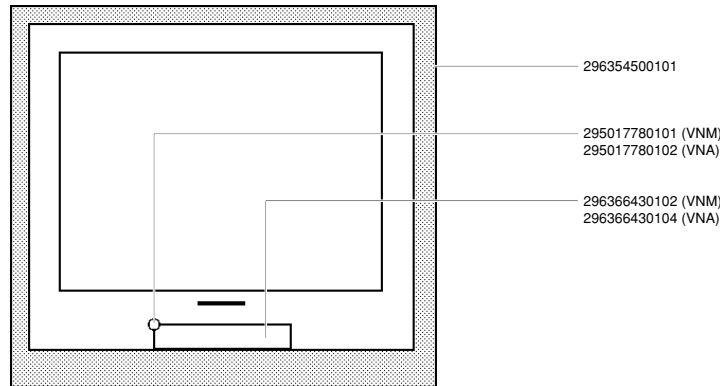

Es gelten die Vorschriften und Sicherheitshinweise gemäß dem Service Manual "Sicherheit", Mat.-Nummer 720108000000, sowie zusätzlich die eventuell abweichenden, landesspezifischen Vorschriften!



The regulations and safety instructions shall be valid as provided by the "Safety" Service Manual, part number 720108000000, as well as the respective national deviations.

ÄNDERUNGEN VORBEHALTEN / SUBJECT TO ALTERATION

GRUNDIG

TV

Ersatzteilliste Spare Parts List

3 / 2002

LEEMAXX 55 ST 55-4105 DOLBY

MATERIAL-NR. / PART NO.: 921981013800 BESTELL-NR. / ORDER NO.: GCM1710 AQUA SILBER / AQUA SILVER
VERSION NR./VERSION NO.: VNA

POS. NR. POS. NO.	ABB. FIG.	MATERIAL-NR. PART NUMBER	ANZ. QTY.	BEZEICHNUNG (D)	DESCRIPTION (GB)
		921981013800		LEEMAXX 55 ST 55-4105 DOLBY AQUA SILBER KEIN E-TEIL	LEEMAXX 55 ST 55-4105 DOLBY AQUA SILBER NO SPARE PART
0200.000		296354500201		191150079700	
0201.000		296354500201	2	GEH-VORDETEIL DRUCK KPL	CABINET FRONT PART PRINT CPL
0216.000		295017790102		HOCHTON-LAUTSPRECHER	TWEETER
0218.000		295017780202		TASTENSATZ PROGRAMM/LAUTSTAERKE	KEY SET PROGRAMME/VOLUME
0221.000		295015200100		TASTENKNOPF NETZSCHALTER	KEY KNOB MAINS SWITCH
0225.000		296366430104		LICHTLEITER	LIGHT GUIDE
0227.000		270412170100		KLAPPE	FLAP
0229.000		295017300101		DRUCKSCHNAPPEPPEP KLASPE	PRESSURE SNAPPER FLAP
0300.000		296366279004		IR-FENSTER	IR WINDOW
0310.000		191440569700	2	GEH-RUECKTEIL	CABINET REAR PART
0311.000		297006220101	2	LAUTSPRECHER BREITBAND	LOUDSPEAKER WIDE BAND
0320.000		291103786402		MONTAGE-FEDER LAUTSPRECHER	ASSEMBLY SPRING LOUDSPEAKER
0700.000		092461287510		TYPENAUFKLEBER VNA	TYPE LABEL SELF ADHESIVE VNA
1100.000		830002051300		ENTMAGNETISIERUNGSSPULE	COIL DEGAUSSING
1100.000		830002065500		BILDROHR A 51 EER33X78 SAMSUNG	PICT. TUBE A 51 EER33X78 SAMSUNG
1100.000		292013600111		BILDROHR A 51 EAL155X01 PHILIPS	PICT. TUBE A 51 EAL155X01 PHILIPS
1110.000		830002058300		BILDROHR A 51 EFS83X191 VIDEOCOLOR	PICT. TUBE A 51 EFS83X191 VIDEOCOLOR
2100.000		829099131600		ANODENKAPPE M.HOCHSPANNUNGSKABEL	ANODE CAP W.HIGH VOLTAGE CABLE
2400.000		296420621900		NETZKABEL KPL M.ENTSSTOERDROSSEL	POWER CABLE CPL W.INTERFER. CHOKE
2410.000		720086738000		TP 750 C FERNBEDIENUNG	TP 750 C REMOTE CONTROL
				DECKEL BATTERIE	BATTERY LID
		219819410300		BEDIENUNGSANLEITUNG D/NL	OPERATING INSTRUCTIONS D/NL
		219819410400		BEDIENUNGSANLEITUNG E/P	OPERATING INSTRUCTIONS E/P
		720100407000		SERVICE MANUAL D/GB	SERVICE MANUAL D/GB
		720100407200		SERVICE MANUAL D/GB 2.ERGAENZUNG	SERVICE MANUAL D/GB 2ND SUPPLEMENT
		720100407400		SERVICE MANUAL D/GB 4.ERGAENZUNG	SERVICE MANUAL D/GB 4TH SUPPLEMENT
		296560040600		MONTAGEZUBEHOER F.BILDROHR	MOUNTING ACCESSORIES F.PICT. TUBE
				KEIN E-TEIL	NO SPARE PART
		297040135900	X	CHASSIS-FS-STEREO	CHASSIS TV STEREO
				CUC 2121 INL DOLBY	CUC 2121 INL DOLBY
				KEIN E-TEIL	NO SPARE PART
				FUER BR A51EAL155X01	FOR PT A51EAL155X01
		297040136000	X	CHASSIS-FS-STEREO	CHASSIS TV STEREO
				CUC 2121 INL DOLBY	CUC 2121 INL DOLBY
				KEIN E-TEIL	NO SPARE PART
				FUER BR A51EFS83X191	FOR PT A51EFS83X191
		297040136100	X	CHASSIS-FS-STEREO	CHASSIS TV STEREO
				CUC 2121 INL DOLBY	CUC 2121 INL DOLBY
				KEIN E-TEIL	NO SPARE PART
				FUER BR A51EER33X78	FOR PT A51EER33X78
				X = SIEHE GESONDERTE E-LISTE	X = SEE SEPARATE PARTS LIST

ÄNDERUNGEN VORBEHALTEN / SUBJECT TO ALTERATION

POS. NR. MATERIAL-NR. BEZEICHNUNG
POS. NO. PART NUMBER DESCRIPTION

POS. NR. MATERIAL-NR. BEZEICHNUNG
POS. NO. PART NUMBER DESCRIPTION

LEEMAXX 55 ST 55-4105 DOLBY

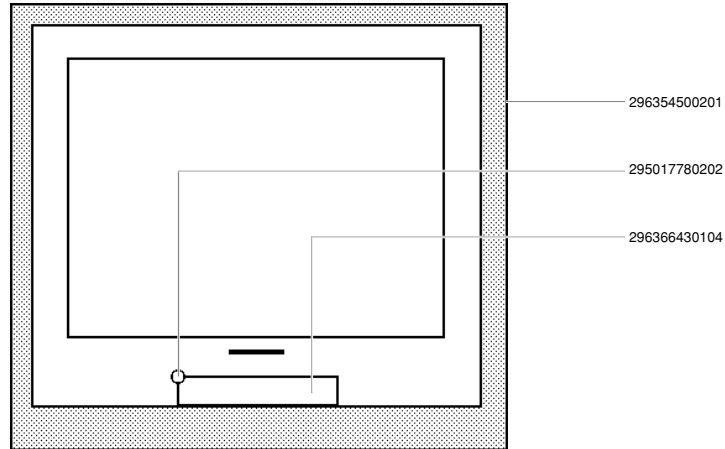

Es gelten die Vorschriften und Sicherheitshinweise gemäß dem Service Manual "Sicherheit", Mat.-Nummer 720108000000, sowie zusätzlich die eventuell abweichenden, landesspezifischen Vorschriften!



The regulations and safety instructions shall be valid as provided by the "Safety" Service Manual, part number 720108000000, as well as the respective national deviations.

ÄNDERUNGEN VORBEHALTEN / SUBJECT TO ALTERATION

Ersatzteilliste Spare Parts List

3 / 2001

GRUNDIG

TV

GREENVILLE SE 5592 DOLBY

MATERIAL-NR. / PART NO.: 92222801750 BESTELL-NR. / ORDER NO.: GBA 2800 SCHWARZ/BLACK
VERSION NR./VERSION NO.: VNM

POS. NR. POS. NO.	ABB. FIG.	MATERIAL-NR. PART NUMBER	ANZ. QTY.	BEZEICHNUNG (D)	DESCRIPTION (GB)
		922228017500		GREENVILLE SE 5592 DOLBY SCHWARZ KEIN E-TEIL	GREENVILLE SE 5592 DOLBY BLACK NO SPARE PART
0200.000		296257360101		GEH-VORDERTEIL OFB	CABINET FRONT PART SURFACE TREATED
0201.000		191260429700	2	LAUTSPRECHER 16 OHM	SPEAKER 16 OHM
0211.000		296338040100		ABDECKUNG CINCH-BUCHSEN	COVER CINCH SOCKETS
0215.000		296337890100		TASTENSATZ PROGRAMM/LAUTSTAERKE	KEYS SET PROGRAMME/VOLUME
0218.000		296337900100		TASTENKNOPF NETZ	KEY KNOB POWER
0229.000		296026035100		EMBLEM GRUNDIG	EMBLEM GRUNDIG
0230.000		296367360101		IR-FENSTER DRUCK KPL	IR WINDOW PRINT CPL
0240.000		293033904200		KOPFHOERERBUCHSE 3,5 O.SCHALTER	HEADPHONE SOCKET 3.5 W/O SWITCH
0241.000		293031680503		CINCH-BUCHSE 3-FACH FBAS/NF L,R	CINCH SOCKET 3 FOLD FBAS/AF L,R
0300.000		296319408705		GEH-RUECKTEIL	CABINET REAR PART
0312.000		297006430104		ABDECKUNG EURO-AV	COVER EURO AV
0320.000		291105496301		TYPENAUFKLEBER VNM	TYPE LABEL VNM
0700.000	△	092461287510		ENTMAGNETISIERUNGSSPULE M.HALTER	COIL DEGAUSSING W.HOLDER
1100.000	△	830002065500		BILDR.A51EAL155X01 PHILIPS	PIC.TUBE A51EAL155X01 PHILIPS
1100.000	△	830002058300		BILDR.A51EFS83X191 VIDEOCOLOR	PIC.TUBE A51EFS83X191 VIDEOCOLOR
1100.000	△	830002051300		BILDR.A51EER33X78 SAMSUNG	PIC.TUBE A51EER33X78 SAMSUNG
1110.000	△	292013600111		ANODENKAPPE M.HOCHSPANNUNGSKABEL	ANODE CAP W.HIGH VOLTAGE
2100.000	△	829099131600		NETZKABEL KPL	POWER CABLE CPL
2300.000		293051223800		BILDROHRPLATTE	PICTURE TUBE BOARD
2400.000		296420621800		TP 750 C FERNBEDIENUNG SCHWARZ	TP 750 C REMOTE CONTROL BLACK
2410.000		267280080001		DECKEL BATTERIE TP 750 C	BATTERY LID TP 750 C
		222289410500		BEDIENUNGSANLEITUNG D	OPERATING INSTRUCTIONS D
		720100407000		SERVICE MANUAL D/GB	SERVICE MANUAL D/GB
		720100407400		SERVICE MANUAL D/GB 4.ERGAENZUNG	SERVICE MANUAL D/GB 4TH SUPPLEMENT
		296560040600		MONTAGEZUBEHOER F.BILDROHR KEIN E-TEIL	MOUNTING ACCESSORIES F.PT NO SPARE PART
		297040130100	X	CHASSIS-FS-STEREO PHILIPS-BR CUC 2121 INL/DOLBY KEIN E-TEIL	CHASSIS TV STEREO PHILIPS PT CUC 2121 INL/DOLBY NO SPARE PART
		297040131000	X	CHASSIS-FS-STEREO VIDEOCOLOR-BR CUC 2121 INL/DOLBY KEIN E-TEIL	CHASSIS TV STEREO VIDEOCOLOR PT CUC 2121 INL/DOLBY NO SPARE PART
		297040132100	X	CHASSIS-FS-STEREO SAMSUNG-BR CUC 2121 INL/DOLBY KEIN E-TEIL	CHASSIS TV STEREO SAMSUNG PT CUC 2121 INL/DOLBY NO SPARE PART
				X=SIEHE GESONDERTE E-LISTE	X=SEE SEPARATE PARTS LIST

ÄNDERUNGEN VORBEHALTEN / SUBJECT TO ALTERATION

POS. NR. MATERIAL-NR. BEZEICHNUNG
POS. NO. PART NUMBER DESCRIPTION

POS. NR. MATERIAL-NR. BEZEICHNUNG
POS. NO. PART NUMBER DESCRIPTION

GREENVILLE SE 5592 DOLBY

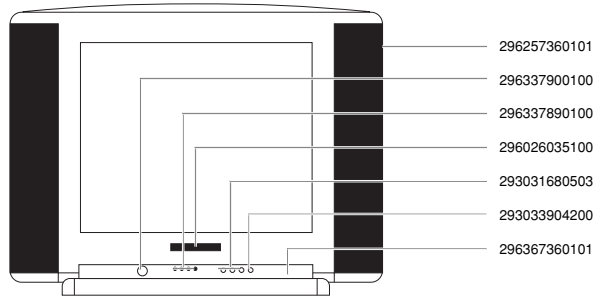

Es gelten die Vorschriften und Sicherheitshinweise gemäß dem Service Manual "Sicherheit", Mat.-Nummer 720108000000, sowie zusätzlich die eventuell abweichenden, landesspezifischen Vorschriften!



The regulations and safety instructions shall be valid as provided by the "Safety" Service Manual, part number 720108000000, as well as the respective national deviations.

ÄNDERUNGEN VORBEHALTEN / SUBJECT TO ALTERATION

Ersatzteilliste Spare Parts List

GRUNDIG

TV

11 / 2001

GREENVILLE SE 5592 DOLBY

MATERIAL-NR. / PART NO.: 922228017500 BESTELL-NR. / ORDER NO.: GBA2800 SCHWARZ/BLACK
VERSION NR./VERSION NO.: VNA

POS. NR. POS. NO.	ABB. FIG.	MATERIAL-NR. PART NUMBER	ANZ. QTY.	BEZEICHNUNG (D)	DESCRIPTION (GB)
		922228017500		GREENVILLE SE 5592 DOLBY SCHWARZ KEIN E-TEIL	GREENVILLE SE 5592 DOLBY BLACK NO SPARE PART
0320.000		291105496401		TYPENAUFKLEBER VNA	TYPE LABEL VNA
		222289410500 720100407000 720100407400		BEDIENUNGSANLEITUNG D SERVICE MANUAL D/GB SERVICE MANUAL D/GB 4.ERGAENZUNG	OPERATING INSTRUCTIONS D SERVICE MANUAL D/GB SERVICE MANUAL D/GB 4TH SUPPLEMENT
		297040135400	X	CHASSIS-FS-STEREO PHILIPS-BR CUC 2121 INL/DOLBY KEIN E-TEIL	CHASSIS TV STEREO PHILIPS PT CUC 2121 INL/DOLBY NO SPARE PART
		297040135500	X	CHASSIS-FS-STEREO VIDEOCOLOR-BR CUC 2121 INL/DOLBY KEIN E-TEIL	CHASSIS TV STEREO VIDEOCOLOR PT CUC 2121 INL/DOLBY NO SPARE PART
		297040135600	X	CHASSIS-FS-STEREO SAMSUNG-BR CUC 2121 INL/DOLBY KEIN E-TEIL	CHASSIS TV STEREO SAMSUNG PT CUC 2121 INL/DOLBY NO SPARE PART
				X=SIEHE GESONDERTE E-LISTE	X=SEE SEPARATE PARTS LIST
				ALLE WEITEREN TEILE SIEHE E-LISTE GREENVILLE SE 5592 DOLBY SCHWARZ MAT.-NR.: 922228017500 BESTELL-NR.: GBA2800 AUSGABE 03/2001 VERSION NR. VNM SIEHE SEITE 55	FOR ALL OTHER PARTS SEE GREENVILLE SE 5592 DOLBY BLACK PART NO: 922228017500 ORDER NR: GBA2800 EDITION 03/2001 VERSION NO VNM SEE PAGE 55

Es gelten die Vorschriften und Sicherheitshinweise gemäß dem Service Manual "Sicherheit", Mat.-Nummer 720108000000, sowie zusätzlich die eventuell abweichenden, landesspezifischen Vorschriften!



The regulations and safety instructions shall be valid as provided by the "Safety" Service Manual, part number 720108000000, as well as the respective national deviations.

ÄNDERUNGEN VORBEHALTEN / SUBJECT TO ALTERATION

Ersatzteilliste
Spare Parts List

3 / 2002

LISSABON 562 SE 5595 DOLBY

MATERIAL-NR. / PART NO.: 921966016900 BESTELL-NR. / ORDER NO.: GCL7575 TESSA BLACK
VERSION NR./VERSION NO.: VNA

POS. NR. POS. NO.	ABB. FIG.	MATERIAL-NR. PART NUMBER	ANZ. QTY.	BEZEICHNUNG (D)	DESCRIPTION (GB)
		921966016900		LISSABON 562 SE 5595 DOLBY TESSA BLACK KEIN E-TEIL	LISSABON 562 SE 5595 DOLBY TESSA BLACK NO SPARE PART
0220.000 0320.000 0700.000	△	296383190602 291103116405 092461287510		ZIERLEISTE KPL TYPENAUFKLEBER VNA ENTMAGNETISIERUNGSSPULE	ORNAMENTAL STRIP CPL TYPE LABEL SELF ADHESIVE VNA COIL DEGAUSSING
		219669410101 720100407000 720100407400		BEDIENUNGSANLEITUNG D SERVICE MANUAL D/GB SERVICE MANUAL D/GB 4.ERGAENZUNG	OPERATION INSTRUCTIONS D SERVICE MANUAL D/GB SERVICE MANUAL D/GB 4TH SUPPLEMENT
		297040135400	X	CHASSIS-FS-STEREO CUC 2121 INL DOLBY KEIN E-TEIL FUER BR A51EAL155X01	CHASSIS TV STEREO CUC 2121 INL DOLBY NO SPARE PART FOR PT A51EAL155X01
		297040135500	X	CHASSIS-FS-STEREO CUC 2121 INL DOLBY KEIN E-TEIL FUER BR A51EFS83X191	CHASSIS TV STEREO CUC 2121 INL DOLBY NO SPARE PART FOR PT A51EFS83X191
				X = SIEHE GESONDERTE E-LISTE	X = SEE SEPARATE PARTS LIST
		720100407000		ALLE WEITEREN TEILE SIEHE E-LISTE LISSABON 562 SE 5595 DOLBY MAT.-NR.: 921966016900 BESTELL-NR.: GCL7575 AUSGABE 11/2000 VERSION NR.: VNM SIEHE SERVICE MANUAL	FOR ALL OTHER PARTS SEE LISSABON 562 SE 5595 DOLBY PART NO.: 921966016900 ORDER NO.: GCL7575 EDITION 11/2000 VERSION NO.: VNM SEE SERVICE MANUAL D/GB

GRUNDIG

TV

POS. NR. MATERIAL-NR. BEZEICHNUNG
POS. NO. PART NUMBER DESCRIPTIONPOS. NR. MATERIAL-NR. BEZEICHNUNG
POS. NO. PART NUMBER DESCRIPTION

LISSABON 562 SE 5595 DOLBY

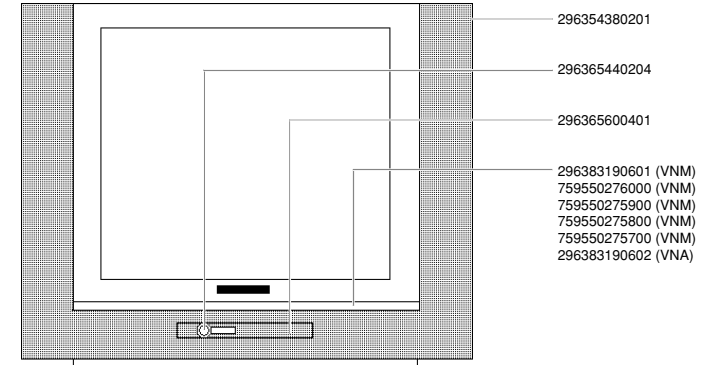

Es gelten die Vorschriften und Sicherheitshinweise gemäß dem Service Manual "Sicherheit", Mat.-Nummer 720108000000, sowie zusätzlich die eventuell abweichenden, landesspezifischen Vorschriften!



The regulations and safety instructions shall be valid as provided by the "Safety" Service Manual, part number 720108000000, as well as the respective national deviations.

ÄNDERUNGEN VORBEHALTEN / SUBJECT TO ALTERATION

ÄNDERUNGEN VORBEHALTEN / SUBJECT TO ALTERATION

Ersatzteilliste
Spare Parts List

TV

2 / 2002

XENTIA 55 ST 55-405/8 DOLBY

MATERIAL-NR. / PART NO.: 921964024000 BESTELL-NR. / ORDER NO.: GCL7200 PROCON SILBER/PROCON SILVER
VERSION NR./VERSION NO.: VNX

POS. NR. POS. NO.	ABB. FIG.	MATERIAL-NR. PART NUMBER	ANZ. QTY.	BEZEICHNUNG (D)	DESCRIPTION (GB)
		921964024000		XENTIA 55 ST 55-405/8 DOLBY PROCON SILBER KEIN E-TEIL	XENTIA 55 ST 55-405/8 DOLBY PROCON SILVER NO SPARE PART
0210.000 WW.		296383190101 759550275700		ZIERLEISTE KPL ALU SILBER ZIERLEISTE KPL BLAU	ORNAMENTAL STRIP CPL ALU SILVER ORNAMENTAL STRIP CPL BLUE
WW.		759550275800		ZIERLEISTE KPL HOLZ DUNKEL	ORNAMENTAL STRIP CPL WOOD DARK
WW.		759550275900		ZIERLEISTE KPL HELL GRUEN	ORNAMENTAL STRIP CPL LIGHT GREEN
WW.		759550276000		ZIERLEISTE KPL ORANGE	ORNAMENTAL STRIP CPL ORANGE
0240.000		293033904200		KOPFHOERERBUCHSE 3,5 O.SCHALTER	HEADPHONE SOCKET 3,5 W/O SWITCH
0241.000		293031680503		CINCH-BUCHSE 3-FACH FBAS/NF L,R	CINCH SOCKET 3 FOLD FBAS/AF L,R
0312.000		297006430104		ABDECKUNG EURO-AV	COVER EURO AV
0320.000		291103106504		TYPENAUFKLEBER VNX	TYPE LABEL VNX
2400.000		296420621900		TP 750 C FERNBEDIENUNG GRAU	TP 750 C REMOTE CONTROL GREY
2410.000		720086738000		DECKEL BATTERIE TP 750 C	BATTERY LID TP 750 C
		219649410301		BEDIENUNGSANLEITUNG GB/F	OPERATING INSTRUCTIONS GB/F
		219649410401		BEDIENUNGSANLEITUNG E/P	OPERATING INSTRUCTIONS E/P
		720100407000		SERVICE MANUAL D/GB	SERVICE MANUAL D/GB
		720100407400		SERVICE MANUAL D/GB 4.ERGAENZUNG	SERVICE MANUAL D/GB 4TH SUPPLEMENT
		297040135700	X	CHASSIS-FS-STEREO CUC 2121 MUL/DOLBY KEIN E-TEIL	CHASSIS TV STEREO CUC 2121 MUL/DOLBY NO SPARE PART
				WW.=WAHLWEISE X=SIEHE GESONDERTE E-LISTE	WW.=OPTIONAL X=SEE SEPARATE PARTS LIST
				ALLE WEITEREN TEILE SIEHE E-LISTE XENTIA 55 ST 55-405/8 DOLBY PROCON SILBER MAT.-NR.: 921964024000 BESTELL-NR.: GCL7200 AUSGABE 9/2001 VERSION NR.: VNA	FOR ALL OTHER PARTS SEE XENTIA 55 ST 55-405/8 DOLBY PROCON SILVER PART NO: 921964024000 ORDER NR: GCL7200 EDITION 9/2001 VERSION NO.: VNA
		720100407500		SIEHE SERVICE MANUAL D/GB 5.ERG.	SEE SERVICE MANUAL D/GB 5TH SUPPL.

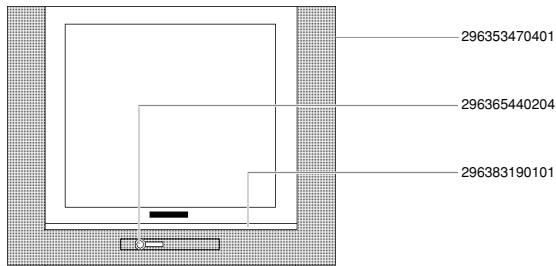

Es gelten die Vorschriften und Sicherheitshinweise gemäß dem Service Manual "Sicherheit", Mat.-Nummer 720108000000, sowie zusätzlich die eventuell abweichenden, landesspezifischen Vorschriften!



The regulations and safety instructions shall be valid as provided by the "Safety" Service Manual, part number 720108000000, as well as the respective national deviations.

ÄNDERUNGEN VORBEHALTEN / SUBJECT TO ALTERATION

Ersatzteilliste
Spare Parts List

TV

2 / 2002

XENTIA 55 ST 55-405/8 DOLBY

MATERIAL-NR. / PART NO.: 921964027700 BESTELL-NR. / ORDER NO.: GCL7277 ELON METALLIC/ELON METALLIC
VERSION NR./VERSION NO.: VNX

POS. NR. POS. NO.	ABB. FIG.	MATERIAL-NR. PART NUMBER	ANZ. QTY.	BEZEICHNUNG (D)	DESCRIPTION (GB)
		921964027700		XENTIA 55 ST 55-405/8 DOLBY ELON METALLIC KEIN E-TEIL	XENTIA 55 ST 55-405/8 DOLBY ELON METALLIC NO SPARE PART
0240.000		293033904200		KOPFHOERERBUCHSE 3,5 O.SCHALTER	HEADPHONE SOCKET 3,5 W/O SWITCH
0241.000		293031680503		CINCH-BUCHSE 3-FACH FBAS/NF L,R	CINCH SOCKET 3 FOLD FBAS/AF L,R
0312.000		297006430104		ABDECKUNG EURO-AV	COVER EURO AV
0320.000		291103106504		TYPENAUFKLEBER VNX	TYPE LABEL VNX
0700.000	△	092461287510		ENTMAGNETISIERUNGSSPULE M.HALTER	COIL DEGAUSSING W.HOLDER
2400.000		296420621900		TP 750 C FERNBEDIENUNG GRAU	TP 750 C REMOTE CONTROL GREY
2410.000		720086738000		DECKEL BATTERIE TP 750 C	BATTERY LID TP 750 C
		219649410301		BEDIENUNGSANLEITUNG GB/F	OPERATING INSTRUCTIONS GB/F
		219649410401		BEDIENUNGSANLEITUNG E/P	OPERATING INSTRUCTIONS E/P
		720100407000		SERVICE MANUAL D/GB	SERVICE MANUAL D/GB
		720100407400		SERVICE MANUAL D/GB 4.ERGAENZUNG	SERVICE MANUAL D/GB 4TH SUPPLEMENT
		297040135700	X	CHASSIS-FS-STEREO CUC 2121 MUL/DOLBY KEIN E-TEIL	CHASSIS TV STEREO CUC 2121 MUL/DOLBY NO SPARE PART
				X=SIEHE GESONDERTE E-LISTE	X=SEE SEPARATE PARTS LIST
				ALLE WEITEREN TEILE SIEHE E-LISTE XENTIA 55 ST 55-405/8 DOLBY ELON METALLIC MAT.-NR.: 921964027700 BESTELL-NR.: GCL7277 AUSGABE 11/2000 VERSION NR.: VNM	FOR ALL OTHER PARTS SEE XENTIA 55 ST 55-405/8 DOLBY ELON METALLIC PART NO: 921964027700 ORDER NR: GCL7277 EDITION 11/2000 VERSION NO.: VNM
		720100407500		SIEHE SERVICE MANUAL D/GB 5.ERG.	SEE SERVICE MANUAL D/GB 5TH SUPPL.

Es gelten die Vorschriften und Sicherheitshinweise gemäß dem Service Manual "Sicherheit", Mat.-Nummer 720108000000, sowie zusätzlich die eventuell abweichenden, landesspezifischen Vorschriften!



The regulations and safety instructions shall be valid as provided by the "Safety" Service Manual, part number 720108000000, as well as the respective national deviations.

ÄNDERUNGEN VORBEHALTEN / SUBJECT TO ALTERATION

GRUNDIG

Ersatzteilliste
Spare Parts List

TV

3 / 2002

ST 55-839/8 DOLBY

MATERIAL-NR. / PART NO.: 921985027500 BESTELL-NR. / ORDER NO.: GCM3200 SCHWARZ/BLACK
VERSION NR./VERSION NO.: VNA

POS. NR. POS. NO.	ABB. FIG.	MATERIAL-NR. PART NUMBER	ANZ. QTY.	BEZEICHNUNG (D)	DESCRIPTION (GB)
		921985027500		ST 55-839/8 DOLBY SCHWARZ KEIN E-TEIL	ST 55-839/8 DOLBY BLACK NO SPARE PART
0320.000 0700.000	△	291103686404 092461287510		TYPENAUFKLEBER VNA ENTMAGNETISIERUNGSSPULE	TYPE LABEL SELF ADHESIVE VNA COIL DEGAUSSING
		219859410201 219859410301 219859410401 720100407000 720100407400		BEDIENUNGSANLEITUNG D/F BEDIENUNGSANLEITUNG I/E BEDIENUNGSANLEITUNG N/FIN SERVICE MANUAL D/GB SERVICE MANUAL D/GB 4.ERGAENZUNG	OPERATING INSTRUCTIONS D/F OPERATING INSTRUCTIONS I/E OPERATING INSTRUCTIONS N/FIN SERVICE MANUAL D/GB SERVICE MANUAL D/GB 4TH SUPPLEMENT
		297040133800	X	CHASSIS-FS-STEREO CUC 2121 MULTI DOLBY KEIN E-TEIL FUER BR A51EAL155X01	CHASSIS TV STEREO CUC 2121 MULTI DOLBY NO SPARE PART FOR PT A51EAL155X01
		297040133900	X	CHASSIS-FS-STEREO CUC 2121 MULTI DOLBY KEIN E-TEIL FUER BR A51EFS83X191	CHASSIS TV STEREO CUC 2121 MULTI DOLBY NO SPARE PART FOR PT A51EFS83X191
		297040134600	X	CHASSIS-FS-STEREO CUC 2121 MULTI DOLBY KEIN E-TEIL FUER BR A51EER33X78	CHASSIS TV STEREO CUC 2121 MULTI DOLBY NO SPARE PART FOR PT A51EER33X78
				X = SIEHE GESONDERTE E-LISTE	X = SEE SEPARATE PARTS LIST
		720100407000		ALLE WEITEREN TEILE SIEHE E-LISTE ST 55-839/8 DOLBY MAT.-NR.: 921985027500 BESTELL-NR.: GCM3200 AUSGABE 12/2000 VERSION NR.: VNM SIEHE SERVICE MANUAL D/GB	FOR ALL OTHER PARTS SEE ST 55-839/8 DOLBY PART NO.: 921985027500 ORDER NO.: GCM3200 EDITION 12/2000 VERSION NO.: VNM SEE SERVICE MANUAL D/GB

Es gelten die Vorschriften und Sicherheitshinweise gemäß dem Service Manual "Sicherheit", Mat.-Nummer 720108000000, sowie zusätzlich die eventuell abweichenden, landesspezifischen Vorschriften!



The regulations and safety instructions shall be valid as provided by the "Safety" Service Manual, part number 720108000000, as well as the respective national deviations.

ÄNDERUNGEN VORBEHALTEN / SUBJECT TO ALTERATION

GRUNDIG

Ersatzteilliste
Spare Parts List

TV

3 / 2002

ST 55-839/8 DOLBY

MATERIAL-NR. / PART NO.: 921985027500 BESTELL-NR. / ORDER NO.: GCM3200 SCHWARZ/BLACK
VERSION NR./VERSION NO.: VNG

POS. NR. POS. NO.	ABB. FIG.	MATERIAL-NR. PART NUMBER	ANZ. QTY.	BEZEICHNUNG (D)	DESCRIPTION (GB)
		921985027500		ST 55-839/8 DOLBY SCHWARZ KEIN E-TEIL	ST 55-839/8 DOLBY BLACK NO SPARE PART
0320.000 0700.000	△	291103686604 092461287510		TYPENAUFKLEBER VNG ENTMAGNETISIERUNGSSPULE	TYPE LABEL SELF ADHESIVE VNG COIL DEGAUSSING
		219859410201 219859410301 219859410401 720100407000 720100407400		BEDIENUNGSANLEITUNG D/F BEDIENUNGSANLEITUNG I/E BEDIENUNGSANLEITUNG N/FIN SERVICE MANUAL D/GB SERVICE MANUAL D/GB 4.ERGAENZUNG	OPERATING INSTRUCTIONS D/F OPERATING INSTRUCTIONS I/E OPERATING INSTRUCTIONS N/FIN SERVICE MANUAL D/GB SERVICE MANUAL D/GB 4TH SUPPLEMENT
		297040130900	X	CHASSIS-FS-STEREO CUC 2121 MULTI DOLBY KEIN E-TEIL FUER BR A51EAL155X01	CHASSIS TV STEREO CUC 2121 MULTI DOLBY NO SPARE PART FOR PT A51EAL155X01
				X = SIEHE GESONDERTE E-LISTE	X = SEE SEPARATE PARTS LIST
		720100407000		ALLE WEITEREN TEILE SIEHE E-LISTE ST 55-839/8 DOLBY MAT.-NR.: 921985027500 BESTELL-NR.: GCM3200 AUSGABE 12/2000 VERSION NR.: VNM SIEHE SERVICE MANUAL D/GB	FOR ALL OTHER PARTS SEE ST 55-839/8 DOLBY PART NO.: 921985027500 ORDER NO.: GCM3200 EDITION 12/2000 VERSION NO.: VNM SEE SERVICE MANUAL D/GB

Es gelten die Vorschriften und Sicherheitshinweise gemäß dem Service Manual "Sicherheit", Mat.-Nummer 720108000000, sowie zusätzlich die eventuell abweichenden, landesspezifischen Vorschriften!



The regulations and safety instructions shall be valid as provided by the "Safety" Service Manual, part number 720108000000, as well as the respective national deviations.

ÄNDERUNGEN VORBEHALTEN / SUBJECT TO ALTERATION

Ersatzteilliste
Spare Parts List

TV

3 / 2002

ST 55-839/8 DOLBY

MATERIAL-NR. / PART NO.: 921985027500 BESTELL-NR. / ORDER NO.: GCM3200 SCHWARZ/BLACK
VERSION NR./VERSION NO.: VNR

POS. NR. ABB. POS. NO. FIG.	MATERIAL-NR. PART NUMBER	ANZ. QTY.	BEZEICHNUNG (D)	DESCRIPTION (GB)
	921985027500		ST 55-839/8 DOLBY SCHWARZ KEIN E-TEIL	ST 55-839/8 DOLBY BLACK NO SPARE PART
0320.000 0700.000	291103686704 092461287510	△	TYPENAUFKLEBER VNR ENTMAGNETISIERUNGSSPULE	TYPE LABEL SELF ADHESIVE VNR COIL DEGAUSSING
	219859410201 219859410301 219859410401 720100407000 720100407400		BEDIENUNGSANLEITUNG D/F BEDIENUNGSANLEITUNG I/E BEDIENUNGSANLEITUNG N/FIN SERVICE MANUAL D/GB SERVICE MANUAL D/GB 4.ERGAENZUNG	OPERATING INSTRUCTIONS D/F OPERATING INSTRUCTIONS I/E OPERATING INSTRUCTIONS N/FIN SERVICE MANUAL D/GB SERVICE MANUAL D/GB 4TH SUPPLEMENT
	297040137900	X	CHASSIS-FS-STEREO CUC 2121 MULTI DOLBY KEIN E-TEIL FUER BR A51EAL155X01	CHASSIS TV STEREO CUC 2121 MULTI DOLBY NO SPARE PART FOR PT A51EAL155X01
	297040138000	X	CHASSIS-FS-STEREO CUC 2121 MULTI DOLBY KEIN E-TEIL FUER BR A51EFS83X191	CHASSIS TV STEREO CUC 2121 MULTI DOLBY NO SPARE PART FOR PT A51EFS83X191
	297040138100	X	CHASSIS-FS-STEREO CUC 2121 MULTI DOLBY KEIN E-TEIL FUER BR A51EER33X78	CHASSIS TV STEREO CUC 2121 MULTI DOLBY NO SPARE PART FOR PT A51EER33X78
			X = SIEHE GESONDERTE E-LISTE	X = SEE SEPARATE PARTS LIST
			ALLE WEITEREN TEILE SIEHE E-LISTE ST 55-839/8 DOLBY MAT.-NR.: 921985027500 BESTELL-NR.: GCM3200 AUSGABE 12/2000 VERSION NR.: VNM	FOR ALL OTHER PARTS SEE ST 55-839/8 DOLBY PART NO.: 921985027500 ORDER NO.: GCM3200 EDITION 12/2000 VERSION NO.: VNM
	720100407000		SIEHE SERVICE MANUAL	SEE SERVICE MANUAL

Es gelten die Vorschriften und Sicherheitshinweise gemäß dem Service Manual "Sicherheit", Mat.-Nummer 720108000000, sowie zusätzlich die eventuell abweichenden, landesspezifischen Vorschriften!



The regulations and safety instructions shall be valid as provided by the "Safety" Service Manual, part number 720108000000, as well as the respective national deviations.

ÄNDERUNGEN VORBEHALTEN / SUBJECT TO ALTERATION

Ersatzteilliste
Spare Parts List

TV

3 / 2002

DAVIO 55 ST 55-854/8 DOLBY

MATERIAL-NR. / PART NO.: 922241029200 BESTELL-NR. / ORDER NO.: GCL2900 ICE BLUE
VERSION NR./VERSION NO.: VNX

POS. NR. ABB. POS. NO. FIG.	MATERIAL-NR. PART NUMBER	ANZ. QTY.	BEZEICHNUNG (D)	DESCRIPTION (GB)
	922241029200		DAVIO 55 ST 55-854/8 DOLBY ICE BLUE KEIN E-TEIL	DAVIO 55 ST 55-854/8 DOLBY ICE BLUE NO SPARE PART
0300.000 0320.000 0700.000	296362630601 291102206503 092461287510	△	GEH-RUECKTEIL OFB TYPENAUFKLEBER VNX ENTMAGNETISIERUNGSSPULE	CABINET REAR PART SURFACE TREATED TYPE LABEL SELF ADHESIVE VNX COIL DEGAUSSING
	219319410900 219319411000 720100407000 720100407400		BEDIENUNGSANLEITUNG D/GB/F BEDIENUNGSANLEITUNG E/P SERVICE MANUAL D/GB SERVICE MANUAL D/GB 4.ERGAENZUNG	OPERATION INSTRUCTIONS D/GB/F OPERATION INSTRUCTIONS E/P SERVICE MANUAL D/GB SERVICE MANUAL D/GB 4TH SUPPLEMENT
	297040135700	X	CHASSIS-FS-STEREO CUC 2121 MULTI DOLBY KEIN E-TEIL FUER BR A51EAL155X01	CHASSIS TV STEREO CUC 2121 MULTI DOLBY NO SPARE PART FOR PT A51EAL155X01
	297040135800	X	CHASSIS-FS-STEREO CUC 2121 MULTI DOLBY KEIN E-TEIL FUER BR A51EFS83X191	CHASSIS TV STEREO CUC 2121 MULTI DOLBY NO SPARE PART FOR PT A51EFS83X191
			X = SIEHE GESONDERTE E-LISTE	X = SEE SEPARATE PARTS LIST
			ALLE WEITEREN TEILE SIEHE E-LISTE DAVIO 55 ST 55-854/8 DOLBY MAT.-NR.: 922241029200 BESTELL-NR.: GCL2900 AUSGABE 3/2001 VERSION NR.: VNM	FOR ALL OTHER PARTS SEE DAVIO 55 ST 55-854/8 DOLBY PART NO.: 922241029200 ORDER NO.: GCL2900 EDITION 3/2001 VERSION NO.: VNM
	720100407000		SIEHE SERVICE MANUAL D/GB	SEE SERVICE MANUAL D/GB

Es gelten die Vorschriften und Sicherheitshinweise gemäß dem Service Manual "Sicherheit", Mat.-Nummer 720108000000, sowie zusätzlich die eventuell abweichenden, landesspezifischen Vorschriften!



The regulations and safety instructions shall be valid as provided by the "Safety" Service Manual, part number 720108000000, as well as the respective national deviations.

ÄNDERUNGEN VORBEHALTEN / SUBJECT TO ALTERATION

GRUNDIG

Ersatzteilliste
Spare Parts List

TV

3 / 2002

DAVIO 55 ST 55-854/8 DOLBY

MATERIAL-NR. / PART NO.: 921931026800 BESTELL-NR. / ORDER NO.: GCL2910 LIGHT GREEN/LIGHT GREEN
VERSION NR./VERSION NO.: VNX

POS. NR. POS. NO.	ABB. FIG.	MATERIAL-NR. PART NUMBER	ANZ. QTY.	BEZEICHNUNG (D)	DESCRIPTION (GB)
		921931026800		DAVIO 55 ST 55-854/8 DOLBY LIGHT GREEN KEIN E-TEIL	DAVIO 55 ST 55-854/8 DOLBY LIGHT GREEN NO SPARE PART
0300.000 0320.000 0700.000		296362630601 291102206503 092461287510		GEH-RUECKTEIL OFB TYPENAUFKLEBER VNX ENTMAGNETISIERUNGSSPULE	CABINET REAR PART SURFACE TREATED TYPE LABEL SELF ADHESIVE VNX COIL DEGAUSSING
		219319410900 219319411000 720100407000 720100407400		BEDIENUNGSANLEITUNG D/GB/F BEDIENUNGSANLEITUNG E/P SERVICE MANUAL D/GB SERVICE MANUAL D/GB 4.ERGAENZUNG	OPERATION INSTRUCTIONS D/GB/F OPERATION INSTRUCTIONS E/P SERVICE MANUAL D/GB SERVICE MANUAL D/GB 4TH SUPPLEMENT
		297040135700	X	CHASSIS-FS-STEREO CUC 2121 MULTI DOLBY KEIN E-TEIL FUER BR A51EAL155X01	CHASSIS TV STEREO CUC 2121 MULTI DOLBY NO SPARE PART FOR PT A51EAL155X01
		297040135800	X	CHASSIS-FS-STEREO CUC 2121 MULTI DOLBY KEIN E-TEIL FUER BR A51EFS83X191	CHASSIS TV STEREO CUC 2121 MULTI DOLBY NO SPARE PART FOR PT A51EFS83X191
				X = SIEHE GESONDERTE E-LISTE	X = SEE SEPARATE PARTS LIST
		720100407000		ALLE WEITEREN TEILE SIEHE E-LISTE DAVIO 55 ST 55-854/8 DOLBY MAT.-NR.: 921931026800 BESTELL-NR.: GCL2910 AUSGABE 3/2001 VERSION NR.: VNM SIEHE SERVICE MANUAL D/GB	FOR ALL OTHER PARTS SEE DAVIO 55 ST 55-854/8 DOLBY PART NO.: 921931026800 ORDER NO.: GCL2910 EDITION 3/2001 VERSION NO.: VNM SEE SERVICE MANUAL D/GB

Es gelten die Vorschriften und Sicherheitshinweise gemäß dem Service Manual "Sicherheit", Mat.-Nummer 720108000000, sowie zusätzlich die eventuell abweichenden, landesspezifischen Vorschriften!



The regulations and safety instructions shall be valid as provided by the "Safety" Service Manual, part number 720108000000, as well as the respective national deviations.

ÄNDERUNGEN VORBEHALTEN / SUBJECT TO ALTERATION

GRUNDIG

Ersatzteilliste
Spare Parts List

TV

3 / 2002

DAVIO 55 ST 55-854/8 DOLBY

MATERIAL-NR. / PART NO.: 921931028900 BESTELL-NR. / ORDER NO.: GCL2920 CORONA SILBER /CORONA SILVER
VERSION NR./VERSION NO.: VNX

POS. NR. POS. NO.	ABB. FIG.	MATERIAL-NR. PART NUMBER	ANZ. QTY.	BEZEICHNUNG (D)	DESCRIPTION (GB)
		921931028900		DAVIO 55 ST 55-854/8 DOLBY CORONA SILBER KEIN E-TEIL	DAVIO 55 ST 55-854/8 DOLBY CORONA SILVER NO SPARE PART
0300.000 0320.000 0700.000		296362630601 291102206503 092461287510		GEH-RUECKTEIL OFB TYPENAUFKLEBER VNX ENTMAGNETISIERUNGSSPULE	CABINET REAR PART SURFACE TREATED TYPE LABEL SELF ADHESIVE VNX COIL DEGAUSSING
		219319410900 219319411000 720100407000 720100407400		BEDIENUNGSANLEITUNG D/GB/F BEDIENUNGSANLEITUNG E/P SERVICE MANUAL D/GB SERVICE MANUAL D/GB 4.ERGAENZUNG	OPERATION INSTRUCTIONS D/GB/F OPERATION INSTRUCTIONS E/P SERVICE MANUAL D/GB SERVICE MANUAL D/GB 4TH SUPPLEMENT
		297040135700	X	CHASSIS-FS-STEREO CUC 2121 MULTI DOLBY KEIN E-TEIL FUER BR A51EAL155X01	CHASSIS TV STEREO CUC 2121 MULTI DOLBY NO SPARE PART FOR PT A51EAL155X01
		297040135800	X	CHASSIS-FS-STEREO CUC 2121 MULTI DOLBY KEIN E-TEIL FUER BR A51EFS83X191	CHASSIS TV STEREO CUC 2121 MULTI DOLBY NO SPARE PART FOR PT A51EFS83X191
				X = SIEHE GESONDERTE E-LISTE	X = SEE SEPARATE PARTS LIST
		720100407000		ALLE WEITEREN TEILE SIEHE E-LISTE DAVIO 55 ST 55-854/8 DOLBY MAT.-NR.: 921931028900 BESTELL-NR.: GCL2920 AUSGABE 3/2001 VERSION NR.: VNM SIEHE SERVICE MANUAL D/GB	FOR ALL OTHER PARTS SEE DAVIO 55 ST 55-854/8 DOLBY PART NO.: 921931028900 ORDER NO.: GCL2920 EDITION 3/2001 VERSION NO.: VNM SEE SERVICE MANUAL D/GB

Es gelten die Vorschriften und Sicherheitshinweise gemäß dem Service Manual "Sicherheit", Mat.-Nummer 720108000000, sowie zusätzlich die eventuell abweichenden, landesspezifischen Vorschriften!



The regulations and safety instructions shall be valid as provided by the "Safety" Service Manual, part number 720108000000, as well as the respective national deviations.

ÄNDERUNGEN VORBEHALTEN / SUBJECT TO ALTERATION

Ersatzteilliste
Spare Parts List

TV

3 / 2002

DAVIO 55 ST 55-854/8 DOLBY

MATERIAL-NR. / PART NO.: 921931027200 BESTELL-NR. / ORDER NO.: GCL2972 AGANA GRAU/AGANA GREY
VERSION NR./VERSION NO.: VNA

POS. NR. POS. NO.	ABB. FIG.	MATERIAL-NR. PART NUMBER	ANZ. QTY.	BEZEICHNUNG (D)	DESCRIPTION (GB)
		921931027200		DAVIO 55 ST 55-854/8 DOLBY AGANA GRAU KEIN E-TEIL	DAVIO 55 ST 55-854/8 DOLBY AGANA GREY NO SPARE PART
0218.000 0320.000 0700.000	△	295016880207 291102206403 092461287510		NETZTASTENKNOPF TYPENAUFKLEBER VNA ENTMAGNETISIERUNGSSPULE	KNOB KEY POWER TYPE LABEL SELF ADHESIVE VNA COIL DEGAUSSING
219319410301 219319410401 219319410501 720100407000 720100407400				BEDIENUNGSANLEITUNG D BEDIENUNGSANLEITUNG GB/E BEDIENUNGSANLEITUNG F/P SERVICE MANUAL D/GB SERVICE MANUAL D/GB 4.ERGAENZUNG	OPERATION INSTRUCTIONS D OPERATION INSTRUCTIONS GB/E OPERATION INSTRUCTIONS F/P SERVICE MANUAL D/GB SERVICE MANUAL D/GB 4TH SUPPLEMENT
297040133600	X			CHASSIS-FS-STEREO CUC 2121 MULTI DOLBY KEIN E-TEIL FUER BR A51EAL155X01	CHASSIS TV STEREO CUC 2121 MULTI DOLBY NO SPARE PART FOR PT A51EAL155X01
297040135000	X			CHASSIS-FS-STEREO CUC 2121 MULTI DOLBY KEIN E-TEIL FUER BR A51EFS83X191	CHASSIS TV STEREO CUC 2121 MULTI DOLBY NO SPARE PART FOR PT A51EFS83X191
				X = SIEHE GESONDERTE E-LISTE	X = SEE SEPARATE PARTS LIST
				ALLE WEITEREN TEILE SIEHE E-LISTE DAVIO 55 ST 55-854/8 DOLBY MAT.-NR.: 921931027200 BESTELL-NR.: GCL2972 AUSGABE 11/2000 VERSION NR.: VNM SIEHE SERVICE MANUAL D/GB	FOR ALL OTHER PARTS SEE DAVIO 55 ST 55-854/8 DOLBY PART NO.: 921931027200 ORDER NO.: GCL2972 EDITION 11/2000 VERSION NO.: VNM SEE SERVICE MANUAL D/GB
720100407000					

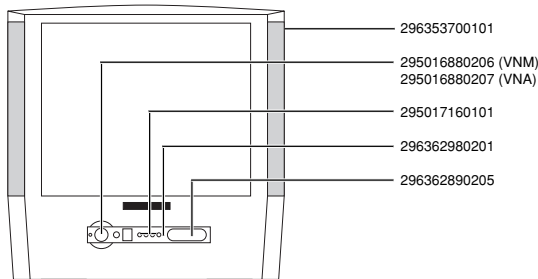

Es gelten die Vorschriften und Sicherheitshinweise gemäß dem Service Manual "Sicherheit", Mat.-Nummer 720108000000, sowie zusätzlich die eventuell abweichenden, landesspezifischen Vorschriften!



The regulations and safety instructions shall be valid as provided by the "Safety" Service Manual, part number 720108000000, as well as the respective national deviations.

ÄNDERUNGEN VORBEHALTEN / SUBJECT TO ALTERATION

Ersatzteilliste
Spare Parts List

TV

3 / 2002

DAVIO 55 ST 55-854/8 DOLBY

MATERIAL-NR. / PART NO.: 921931027200 BESTELL-NR. / ORDER NO.: GCL2972 AGANA GRAU/AGANA GREY
VERSION NR./VERSION NO.: VNX

POS. NR. POS. NO.	ABB. FIG.	MATERIAL-NR. PART NUMBER	ANZ. QTY.	BEZEICHNUNG (D)	DESCRIPTION (GB)
		921931027200		DAVIO 55 ST 55-854/8 DOLBY AGANA GRAU KEIN E-TEIL	DAVIO 55 ST 55-854/8 DOLBY AGANA GREY NO SPARE PART
0218.000 0320.000 0700.000	△	295016880207 291102206503 092461287510		NETZTASTENKNOPF TYPENAUFKLEBER VNX ENTMAGNETISIERUNGSSPULE	KNOB KEY POWER TYPE LABEL SELF ADHESIVE VNX COIL DEGAUSSING
219319410900 219319411000 720100407000 720100407400				BEDIENUNGSANLEITUNG D/GB/F BEDIENUNGSANLEITUNG E/P SERVICE MANUAL D/GB SERVICE MANUAL D/GB 4.ERGAENZUNG	OPERATION INSTRUCTIONS D/GB/F OPERATION INSTRUCTIONS E/P SERVICE MANUAL D/GB SERVICE MANUAL D/GB 4TH SUPPLEMENT
297040135700	X			CHASSIS-FS-STEREO CUC 2121 MULTI DOLBY KEIN E-TEIL FUER BR A51EAL155X01	CHASSIS TV STEREO CUC 2121 MULTI DOLBY NO SPARE PART FOR PT A51EAL155X01
297040135800	X			CHASSIS-FS-STEREO CUC 2121 MULTI DOLBY KEIN E-TEIL FUER BR A51EFS83X191	CHASSIS TV STEREO CUC 2121 MULTI DOLBY NO SPARE PART FOR PT A51EFS83X191
				X = SIEHE GESONDERTE E-LISTE	X = SEE SEPARATE PARTS LIST
				ALLE WEITEREN TEILE SIEHE E-LISTE DAVIO 55 ST 55-854/8 DOLBY MAT.-NR.: 921931027200 BESTELL-NR.: GCL2972 AUSGABE 11/2000 VERSION NR.: VNM SIEHE SERVICE MANUAL D/GB	FOR ALL OTHER PARTS SEE DAVIO 55 ST 55-854/8 DOLBY PART NO.: 921931027200 ORDER NO.: GCL2972 EDITION 11/2000 VERSION NO.: VNM SEE SERVICE MANUAL D/GB
720100407000					

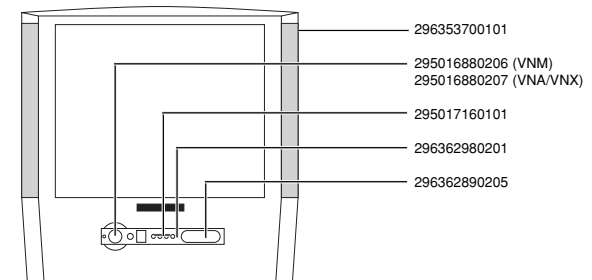

Es gelten die Vorschriften und Sicherheitshinweise gemäß dem Service Manual "Sicherheit", Mat.-Nummer 720108000000, sowie zusätzlich die eventuell abweichenden, landesspezifischen Vorschriften!



The regulations and safety instructions shall be valid as provided by the "Safety" Service Manual, part number 720108000000, as well as the respective national deviations.

ÄNDERUNGEN VORBEHALTEN / SUBJECT TO ALTERATION

GRUNDIG

TV

Ersatzteilliste
Spare Parts List

1 / 2002

ST 55-908/8 DOLBY

MATERIAL-NR. / PART NO.: 921965027500 BESTELL-NR. / ORDER NO.: GCL7475 SCHWARZ/BLACK
VERSION NR./VERSION NO.: VNX

POS. NR. POS. NO.	ABB. FIG.	MATERIAL-NR. PART NUMBER	ANZ. QTY.	BEZEICHNUNG (D)	DESCRIPTION (GB)
		921965027500		ST 55-908/8 DOLBY SCHWARZ KEIN E-TEIL	ST 55-908/8 DOLBY BLACK NO SPARE PART
0312.000		297006430104		ABDECKUNG EURO-AV	COVER EURO AV
0320.000		291103086504		TYPENAUFKLEBER VNX	TYPE LABEL VNX
0700.000		092461287510		ENTMAGNETISIERUNGSSPULE M.HALTER	COIL DEGAUSSING W.HOLDER
1100.000	△	830002065500		BILDR.A51EAL155X01 PHILIPS	PIC.TUBE A51EAL155X01 PHILIPS
1100.000	△	830002058300		BILDR.A51EER33X78 SAMSUNG	PIC.TUBE A51EER33X78 SAMSUNG
1100.000	△	830002051300		BILDR.A51EER33X78 SAMSUNG	PIC.TUBE A51EER33X78 SAMSUNG
219659411700				BEDIENUNGSANLEITUNG GB/F/E/P	OPERATING INSTRUCTIONS GB/F/E/P
219659411800				BEDIENUNGSANLEITUNG NL/DK/N/S	OPERATING INSTRUCTIONS NL/DK/N/S
219659411900				BEDIENUNGSANLEITUNG FIN/H/PL/CZ	OPERATING INSTRUCTIONS FIN/H/PL/CZ
720100407000				SERVICE MANUAL D/GB	SERVICE MANUAL D/GB
720100407400				SERVICE MANUAL D/GB 4.ERGAENZUNG	SERVICE MANUAL D/GB 4TH SUPPLEMENT
297040136300		X		CHASSIS-FS-STEREO PHILIPS-BR CUC 2121 MUL/DOLBY KEIN E-TEIL	CHASSIS TV STEREO PHILIPS PT CUC 2121 MUL/DOLBY NO SPARE PART
297040136400		X		CHASSIS-FS-STEREO VIDEOCOLOR-BR CUC 2121 MUL/DOLBY KEIN E-TEIL	CHASSIS TV STEREO VIDEOCOLOR PT CUC 2121 MUL/DOLBY NO SPARE PART
297040136500		X		CHASSIS-FS-STEREO SAMSUNG-BR CUC 2121 MUL/DOLBY KEIN E-TEIL	CHASSIS TV STEREO SAMSUNG PT CUC 2121 MUL/DOLBY NO SPARE PART
				X = SIEHE GESONDERTE E-LISTE	X = SEE SEPARATE PARTS LIST
				ALLE WEITEREN TEILE SIEHE E-LISTE ST 55-908/8 DOLBY SCHWARZ MAT.-NR.: 921965027500 BESTELL-NR.: GCL7475 AUSGABE 1/2001 VERSION NR. VNM	FOR ALL OTHER PARTS SEE ST 55-908/8 DOLBY BLACK PART NO.: 921965027500 ORDER NR.: GCL7475 EDITION 1/2001 VERSION NO VNM
				720100407000 SIEHE SERVICE MANUAL	SEE SERVICE MANUAL D/GB 2

Es gelten die Vorschriften und Sicherheitshinweise gemäß dem Service Manual "Sicherheit", Mat.-Nummer 720108000000, sowie zusätzlich die eventuell abweichenden, landesspezifischen Vorschriften!



The regulations and safety instructions shall be valid as provided by the "Safety" Service Manual, part number 720108000000, as well as the respective national deviations.

ÄNDERUNGEN VORBEHALTEN / SUBJECT TO ALTERATION

GRUNDIG

TV

Ersatzteilliste
Spare Parts List

1 / 2002

ST 55-908/8 DOLBY

MATERIAL-NR. / PART NO.: 921965029200 BESTELL-NR. / ORDER NO.: GCL7492 TITANE
VERSION NR./VERSION NO.: VNX

POS. NR. POS. NO.	ABB. FIG.	MATERIAL-NR. PART NUMBER	ANZ. QTY.	BEZEICHNUNG (D)	DESCRIPTION (GB)
		921965029200		ST 55-908/8 DOLBY TITANE KEIN E-TEIL	ST 55-908/8 DOLBY TITANE NO SPARE PART
0312.000		297006430104		ABDECKUNG EURO-AV	COVER EURO AV
0320.000		291103086504		TYPENAUFKLEBER VNX	TYPE LABEL VNX
0700.000		092461287510		ENTMAGNETISIERUNGSSPULE M.HALTER	COIL DEGAUSSING W.HOLDER
1100.000	△	830002065500		BILDR.A51EAL155X01 PHILIPS	PIC.TUBE A51EAL155X01 PHILIPS
1100.000	△	830002058300		BILDR.A51EER33X78 SAMSUNG	PIC.TUBE A51EER33X78 SAMSUNG
1100.000	△	830002051300		BILDR.A51EER33X78 SAMSUNG	PIC.TUBE A51EER33X78 SAMSUNG
2400.000		296420621800		TP 750 C FERNBEDIENUNG SCHWARZ	TP 750 C REMOTE CONTROL BLACK
2410.000		267280080001		DECKEL BATTERIE TP 750 C	BATTERY LID TP 750 C
219659411700				BEDIENUNGSANLEITUNG GB/F/E/P	OPERATING INSTRUCTIONS GB/F/E/P
219659411800				BEDIENUNGSANLEITUNG NL/DK/N/S	OPERATING INSTRUCTIONS NL/DK/N/S
219659411900				BEDIENUNGSANLEITUNG FIN/H/PL/CZ	OPERATING INSTRUCTIONS FIN/H/PL/CZ
720100407000				SERVICE MANUAL D/GB	SERVICE MANUAL D/GB
720100407400				SERVICE MANUAL D/GB 4.ERGAENZUNG	SERVICE MANUAL D/GB 4TH SUPPLEMENT
297040136300		X		CHASSIS-FS-STEREO PHILIPS-BR CUC 2121 MUL/DOLBY KEIN E-TEIL	CHASSIS TV STEREO PHILIPS PT CUC 2121 MUL/DOLBY NO SPARE PART
297040136400		X		CHASSIS-FS-STEREO VIDEOCOLOR-BR CUC 2121 MUL/DOLBY KEIN E-TEIL	CHASSIS TV STEREO VIDEOCOLOR PT CUC 2121 MUL/DOLBY NO SPARE PART
297040136500		X		CHASSIS-FS-STEREO SAMSUNG-BR CUC 2121 MUL/DOLBY KEIN E-TEIL	CHASSIS TV STEREO SAMSUNG PT CUC 2121 MUL/DOLBY NO SPARE PART
				X = SIEHE GESONDERTE E-LISTE	X = SEE SEPARATE PARTS LIST
				ALLE WEITEREN TEILE SIEHE E-LISTE ST 55-908/8 DOLBY TITANE MAT.-NR.: 921965029200 BESTELL-NR.: GCL7492 AUSGABE 1/2001 VERSION NR.: VNM	FOR ALL OTHER PARTS SEE ST 55-908/8 DOLBY TITANE PART NO.: 921965029200 ORDER NR.: GCL7492 EDITION 1/2001 VERSION NO.: VNM
				720100407000 SIEHE SERVICE MANUAL D/GB	SEE SERVICE MANUAL D/GB

Es gelten die Vorschriften und Sicherheitshinweise gemäß dem Service Manual "Sicherheit", Mat.-Nummer 720108000000, sowie zusätzlich die eventuell abweichenden, landesspezifischen Vorschriften!



The regulations and safety instructions shall be valid as provided by the "Safety" Service Manual, part number 720108000000, as well as the respective national deviations.

ÄNDERUNGEN VORBEHALTEN / SUBJECT TO ALTERATION

Ersatzteilliste
Spare Parts List

TV

1 / 2002

LEEMAXX 55 ST 55-4105 MV/DOLBY

MATERIAL-NR. / PART NO.: 921981028900 BESTELL-NR. / ORDER NO.: GCM6600 CORONA SILBER/CORONA SILVER
VERSION NR./VERSION NO.: VNX

POS. NR. POS. NO.	ABB. FIG.	MATERIAL-NR. PART NUMBER	ANZ. QTY.	BEZEICHNUNG (D)	DESCRIPTION (GB)
		921981028900		LEEMAXX 55 ST 55-4105 MV/DOLBY CORONA SILBER KEIN E-TEIL	LEEMAXX 55 ST 55-4105 MV/DOLBY CORONA SILVER NO SPARE PART
0218.000		295017780102		TASTENKNOPF NETZSCHALTER	KEY KNOB MAINS SWITCH
0225.000		296366430104		KLAPPE BEDIENUNG	FLAP CONTROL
0240.000		293033904200		KOPFHÖRERBUCHSE 3,5 O.SCHALTER	HEADPHONE SOCKET 3,5 W/O SWITCH
0241.000		293031680503		CINCH-BUCHSE 3-FACH FBAS/NF L,R	CINCH SOCKET 3 FOLD FBAS/AF L,R
0300.000		296366278905		GEH-RUECKTEIL	CABINET REAR PART
0311.000		297006220102	2	MONTAGE-FEDER LS BREITBAND	ASSEMBLY SPRING SPEAKER WIDE BAND
0312.000		297006430104		ABDECKUNG EURO-AV	COVER EURO AV
0320.000		291103796503		TYPENAUFKLEBER VNX	TYPE LABEL VNX
0700.000	△	092461287510		ENTMAGNETISIERUNGSSPULE M.HALTER	COIL DEGAUSSING W.HOLDER
2400.000		296420621800		TP 750 C FERNBEDIENUNG SCHWARZ	TP 750 C REMOTE CONTROL BLACK
2410.000		267280080001		DECKEL BATTERIE TP 750 C	BATTERY LID TP 750 C
		219819410502		BEDIENUNGSANLEITUNG D/NL	OPERATING INSTRUCTIONS D/NL
		219819410601		BEDIENUNGSANLEITUNG F/I	OPERATING INSTRUCTIONS F/I
		219819410701		BEDIENUNGSANLEITUNG E/P	OPERATING INSTRUCTIONS E/P
		720100407000		SERVICE MANUAL D/GB	SERVICE MANUAL D/GB
		720100407400		SERVICE MANUAL D/GB 4.ERGAENZUNG	SERVICE MANUAL D/GB 4TH SUPPLEMENT
		297040136200	X	CHASSIS-FS-STEREO CUC 2121 MUL/DOLBY KEIN E-TEIL	CHASSIS TV STEREO CUC 2121 MUL/DOLBY NO SPARE PART
				X = SIEHE GESONDERTE E-LISTE	X = SEE SEPARATE PARTS LIST
				ALLE WEITEREN TEILE SIEHE E-LISTE LEEMAXX 55 ST 55-4105 MV/DOLBY CORONA SILBER MAT.-NR.: 921981028900 BESTELL-NR.: GCM6600 AUSGABE 3/2001 VERSION NR.: VNM	FOR ALL OTHER PARTS SEE LEEMAXX 55 ST 55-4105 MV/DOLBY CORONA SILVER PART NO.: 921981028900 ORDER NR.: GCM6600 EDITION 3/2001 VERSION NO.: VNM
		720100407200		SIEHE SERVICE MANUAL D/GB 2.ERG.	SEE SERVICE MANUAL D/GB 2TH SUPPL.

ÄNDERUNGEN VORBEHALTEN / SUBJECT TO ALTERATION

POS. NR. MATERIAL-NR. BEZEICHNUNG
POS. NO. PART NUMBER DESCRIPTIONPOS. NR. MATERIAL-NR. BEZEICHNUNG
POS. NO. PART NUMBER DESCRIPTION

LEEMAXX 55 ST 55-4105 MV/DOLBY

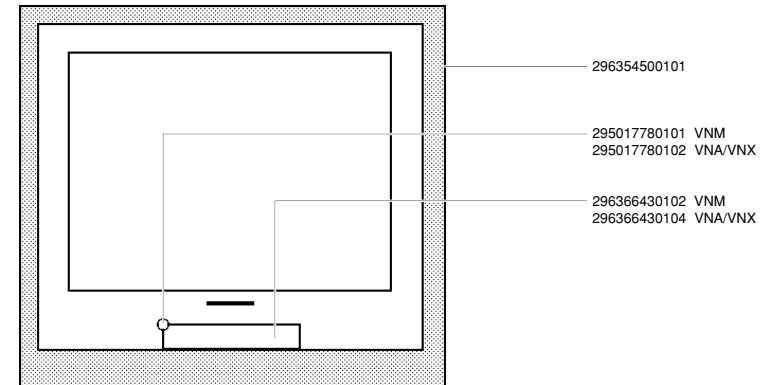

Es gelten die Vorschriften und Sicherheitshinweise gemäß dem Service Manual "Sicherheit", Mat.-Nummer 720108000000, sowie zusätzlich die eventuell abweichenden, landesspezifischen Vorschriften!



The regulations and safety instructions shall be valid as provided by the "Safety" Service Manual, part number 720108000000, as well as the respective national deviations.

ÄNDERUNGEN VORBEHALTEN / SUBJECT TO ALTERATION

GRUNDIG**TV**Ersatzteilliste
Spare Parts List**3 / 2002****LEEMAXX 55 ST 55-4105 MV DOLBY**MATERIAL-NR. / PART NO.: 921981023800 BESTELL-NR. / ORDER NO.: GCM6610 AQUA SILBER/AQUA SILVER
VERSION NR./VERSION NO.: VNX

POS. NR. POS. NO.	ABB. FIG.	MATERIAL-NR. PART NUMBER	ANZ. QTY.	BEZEICHNUNG (D)	DESCRIPTION (GB)
		921981023800		LEEMAXX 55 ST 55-4105 MV/DOLBY AQUA SILBER KEIN E-TEIL	LEEMAXX 55 ST 55-4105 MV/DOLBY AQUA SILVER NO SPARE PART
0200.000		296354500201		GEH-VORDETEIL DRUCK KPL	CABINET FRONT PART PRINT CPL
0201.000		191150079700	2	HOCHTON-LAUTSPRECHER	TWEETER
0216.000		295017790102		TASTENSATZ PROGRAMM/LAUTSTAERKE	KEY SET PROGRAMME/VOLUME
0218.000		295017780202		TASTENKNOPF NETZSCHALTER	KEY KNOB MAINS SWITCH
0221.000		295015200100		LICHTLEITER	LIGHT GUIDE
0225.000		296366430104		KLAPPE	FLAP
0226.000		270412170100		DRUCKSCHNAEPPER Klappe	PRESSURE SNAPPER FLAP
0230.000		295017300101		IR-FENSTER	IR WINDOW
0240.000		293033904200		KOPFHUERBUCHSE 3,5mm O.SCHALTER	HEADPHONE SOCKET 3,5mm W/O SWITCH
0241.000		293031680503		CINCH-BUCHSE 3FACH FBAS/NF L,R	CINCH SOCKET 3 FOLD FBAS/AF L,R
0300.000		296366279004		GEH-RUECKTEIL	CABINET REAR PART
0310.000		191440569700	2	LAUTSPRECHER BREITBAND	LOUDSPEAKER WIDE BAND
0311.000		297006220101	2	MONTAGE-FEDER LAUTSPRECHER	ASSEMBLY SPRING LOUDSPEAKER
0312.000		297006430104		ABDECKUNG EURO-AV	COVER EURO AV
0320.000		291103796503		TYPENAUFKLEBER VNX	TYPE LABEL SELF ADHESIVE VNX
0700.000	△	092461267510		ENTMAGNETISIERUNGSSPULE	COIL DEGAUSSING
1110.000	△	292013600111		ANODENKAPPE M.HOCHSPANNUNGSKABEL	ANODE CAP W.HIGH VOLTAGE CABLE
2100.000	△	829099131600		NETZKABEL KPL M.ENTSTOERDROSSEL	POWER CABLE CPL W.INTERFER. CHOKE
2300.000		293051223800	X	BILDROHRPLATTE	PICTURE TUBE BOARD
2400.000		296420621900		TP 750 C FERNBEDIENUNG	TP 750 C REMOTE CONTROL
2410.000		267280080001		DECKEL BATTERIE	BATTERY LID
219819410502				BEDIENUNGSANLEITUNG D/NL	OPERATION INSTRUCTIONS D/N
219819410601				BEDIENUNGSANLEITUNG F/I	OPERATION INSTRUCTIONS F/I
219819410701				BEDIENUNGSANLEITUNG E/P	OPERATION INSTRUCTIONS E/P
720100407000				SERVICE MANUAL D/GB	SERVICE MANUAL D/GB
720100407400				SERVICE MANUAL D/GB 4.ERGAENZUNG	SERVICE MANUAL D/GB 4TH SUPPLEMENT
296560040600				MONTAGEZUBEHOER F.BILDROHR KEIN E-TEIL	MOUNTING ACCESSORIES F.PICT. TUBE NO SPARE PART
297040136200			X	CHASSIS-FS-STEREO CUC 2121 MULTI DOLBY KEIN E-TEIL	CHASSIS TV STEREO CUC 2121 MULTI DOLBY NO SPARE PART
				X = SIEHE GESONDERTE E-LISTE	X = SEE SEPARATE PARTS LIST

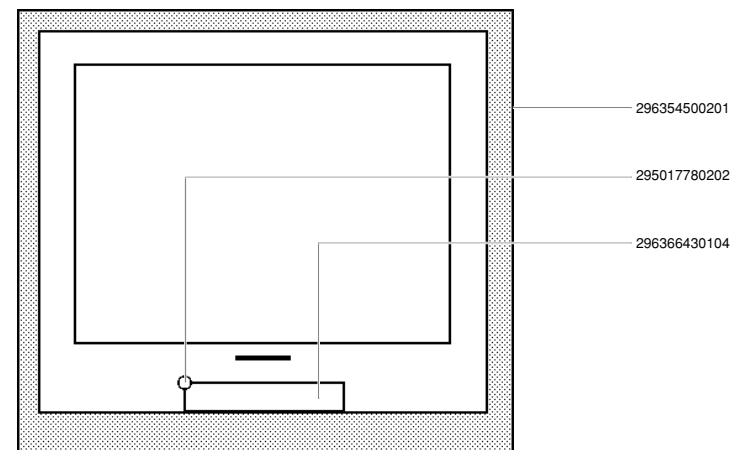
POS. NR. MATERIAL-NR. BEZEICHNUNG
POS. NO. PART NUMBER DESCRIPTIONPOS. NR. MATERIAL-NR. BEZEICHNUNG
POS. NO. PART NUMBER DESCRIPTION**LEEMAXX 55 ST 55-4105 MV DOLBY**

Es gelten die Vorschriften und Sicherheitshinweise gemäß dem Service Manual "Sicherheit", Mat.-Nummer 720108000000, sowie zusätzlich die eventuell abweichenden, landesspezifischen Vorschriften!



The regulations and safety instructions shall be valid as provided by the "Safety" Service Manual, part number 720108000000, as well as the respective national deviations.

ÄNDERUNGEN VORBEHALTEN / SUBJECT TO ALTERATION

ÄNDERUNGEN VORBEHALTEN / SUBJECT TO ALTERATION

Ersatzteilliste
Spare Parts List

TV

1 / 2002

GREENVILLE SE 5592 MV/DOLBY

MATERIAL-NR. / PART NO.: 922228027500 BESTELL-NR. / ORDER NO.: GCN1600 SCHWARZ/BLACK
VERSION NR./VERSION NO.: VNX

POS. NR. ABB. POS. NO. FIG.	MATERIAL-NR. PART NUMBER	ANZ. QTY.	BEZEICHNUNG (D)	DESCRIPTION (GB)
	922228027500		GREENVILLE SE 5592 MV/DOLBY SCHWARZ KEIN E-TEIL	GREENVILLE SE 5592 MV/DOLBY BLACK NO SPARE PART
0320.000 0700.000	291104466502 092461287510	△	TYPENAUFKLEBER VNX ENTMAGNETISIERUNGSSPULE M.HALTER	TYPE LABEL VNX COIL DEGAUSSING W.HOLDER
	222289410102 720100407000 720100407200		BEDIENUNGSANLEITUNG D/H/PL/CZ SERVICE MANUAL D/GB SERVICE MANUAL D/GB 2.ERGAENZUNG	OPERATING INSTRUCTIONS D/H/PL/CZ SERVICE MANUAL D/GB SERVICE MANUAL D/GB 2ND SUPPLEMENT
	720100407200		ALLE WEITEREN TEILE SIEHE E-LISTE GREENVILLE SE 5592 MV/DOLBY SCHWARZ MAT.-NR.: 922228027500 BESTELL-NR.: GCN1600 AUSGABE 4/2001 VERSION NR.: VNM SIEHE SERVICE MANUAL D/GB 2.ERG.	FOR ALL OTHER PARTS SEE GREENVILLE SE 5592 MV/DOLBY BLACK PART NO.: 922228027500 ORDER NR.: GCN1600 EDITION 4/2001 VERSION NO.: VNM SEE SERVICE MANUAL D/GB 2TH SUPPL.

Ersatzteilliste
Spare Parts List

TV

1 / 2002

GREENVILLE SE 5592 MV/DOLBY

MATERIAL-NR. / PART NO.: 922228027500 BESTELL-NR. / ORDER NO.: GCN1600 SCHWARZ/BLACK
VERSION NR./VERSION NO.: VNG

POS. NR. ABB. POS. NO. FIG.	MATERIAL-NR. PART NUMBER	ANZ. QTY.	BEZEICHNUNG (D)	DESCRIPTION (GB)
	922228027500		GREENVILLE SE 5592 MV/DOLBY SCHWARZ KEIN E-TEIL	GREENVILLE SE 5592 MV/DOLBY BLACK NO SPARE PART
0320.000 0700.000	291104466602 092461287510	△	TYPENAUFKLEBER VNG ENTMAGNETISIERUNGSSPULE M.HALTER	TYPE LABEL VNG COIL DEGAUSSING W.HOLDER
	222289410102 720100407000 720100407400		BEDIENUNGSANLEITUNG D/H/PL/CZ SERVICE MANUAL D/GB SERVICE MANUAL D/GB 4.ERGAENZUNG	OPERATING INSTRUCTIONS D/H/PL/CZ SERVICE MANUAL D/GB SERVICE MANUAL D/GB 4TH SUPPLEMENT
	297040137300	X	CHASSIS-FS-STEREO PHILIPS-BR CUC 2121 MUL/DOLBY KEIN E-TEIL	CHASSIS TV STEREO PHILIPS PT CUC 2121 MUL/DOLBY NO SPARE PART
	297040137400	X	CHASSIS-FS-STEREO VIDEOCOLOR-BR CUC 2121 MUL/DOLBY KEIN E-TEIL	CHASSIS TV STEREO VIDEOCOLOR PT CUC 2121 MUL/DOLBY NO SPARE PART
	297040137500	X	CHASSIS-FS-STEREO SAMSUNG-BR CUC 2121 MUL/DOLBY KEIN E-TEIL	CHASSIS TV STEREO SAMSUNG PT CUC 2121 MUL/DOLBY NO SPARE PART
			X = SIEHE GESONDERTE E-LISTE	X = SEE SEPARATE PARTS LIST
	720100407200		ALLE WEITEREN TEILE SIEHE E-LISTE GREENVILLE SE 5592 MV/DOLBY SCHWARZ MAT.-NR.: 922228027500 BESTELL-NR.: GCN1600 AUSGABE 4/2001 VERSION NR.: VNM SIEHE SERVICE MANUAL D/GB 2.ERG.	FOR ALL OTHER PARTS SEE GREENVILLE SE 5592 MV/DOLBY BLACK PART NO.: 922228027500 ORDER NR.: GCN1600 EDITION 4/2001 VERSION NO.: VNM SEE SERVICE MANUAL D/GB 2TH SUPPL.

Es gelten die Vorschriften und Sicherheitshinweise gemäß dem Service Manual "Sicherheit", Mat.-Nummer 720108000000, sowie zusätzlich die eventuell abweichenden, landesspezifischen Vorschriften!



The regulations and safety instructions shall be valid as provided by the "Safety" Service Manual, part number 720108000000, as well as the respective national deviations.

ÄNDERUNGEN VORBEHALTEN / SUBJECT TO ALTERATION

Es gelten die Vorschriften und Sicherheitshinweise gemäß dem Service Manual "Sicherheit", Mat.-Nummer 720108000000, sowie zusätzlich die eventuell abweichenden, landesspezifischen Vorschriften!



The regulations and safety instructions shall be valid as provided by the "Safety" Service Manual, part number 720108000000, as well as the respective national deviations.

ÄNDERUNGEN VORBEHALTEN / SUBJECT TO ALTERATION

GRUNDIGErsatzteilliste
Spare Parts List**TV****5 / 2001****ST 55-734 GB/DOLBY**MATERIAL-NR. / PART NO.: 921967639200 BESTELL-NR. / ORDER NO.: GCL7375GB TITANE
VERSION NR./VERSION NO.: VNA

POS. NR. POS. NO.	ABB. FIG.	MATERIAL-NR. PART NUMBER	ANZ. QTY.	BEZEICHNUNG (D)	DESCRIPTION (GB)
		921967639200		ST 55-734 GB/DOLBY TITANE KEIN E-TEIL	ST 55-734 GB/DOLBY TITANE NO SPARE PART
0300.000 0320.000 0700.000!		296319408904 291103226401 092461287510		GEH-RUECKTEIL TYPENAUFKLEBER VNA ENTMAGNETISIERUNGSSPULE	CABINET REAR PART TYPE LABEL SELF ADHESIVE VNA COIL DEGAUSSING
		297040133100	X	CHASSIS-FS-STEREO CUC 2121 GB/DOLBY KEIN E-TEIL	CHASSIS TV STEREO CUC 2121 GB/DOLBY NO SPARE PART
				X = SIEHE GESONDERTE E-LISTE	X = SEE SEPARATE PARTS LIST
		720100407100		ALLE WEITEREN TEILE SIEHE E-LISTE ST 55-734 GB/DOLBY MAT.-NR.: 921967639200 BESTELL-NR.: GCL7375 AUSGABE 3/2001 VERSION NR.: VNM SIEHE SERVICE MANUAL D/GB 1.ERG.	FOR ALL OTHER PARTS SEE ST 55-734 GB/DOLBY PART NO.: 921967639200 ORDER NO.: GCL7375 EDITION 3/2001 VERSION NO.: VNM SEE SERVICE MANUAL D/GB 1TH SUPPL.

Es gelten die Vorschriften und Sicherheitshinweise gemäß dem Service Manual "Sicherheit", Mat.-Nummer 720108000000, sowie zusätzlich die eventuell abweichenden, landesspezifischen Vorschriften!



The regulations and safety instructions shall be valid as provided by the "Safety" Service Manual, part number 720108000000, as well as the respective national deviations.

ÄNDERUNGEN VORBEHALTEN / SUBJECT TO ALTERATION

GRUNDIGErsatzteilliste
Spare Parts List**TV****3 / 2002****ST 55-734 GB/DOLBY**MATERIAL-NR. / PART NO.: 921967639200 BESTELL-NR. / ORDER NO.: GCL7375GB TITANE
VERSION NR./VERSION NO.: VNX

POS. NR. POS. NO.	ABB. FIG.	MATERIAL-NR. PART NUMBER	ANZ. QTY.	BEZEICHNUNG (D)	DESCRIPTION (GB)
		921967639200		ST 55-734 GB/DOLBY TITANE KEIN E-TEIL	ST 55-734 GB/DOLBY TITANE NO SPARE PART
0320.000 0700.000		291103226501 092461287510		TYPENAUFKLEBER VNX ENTMAGNETISIERUNGSSPULE	TYPE LABEL SELF ADHESIVE VNX COIL DEGAUSSING
		219679410101 720100407000 720100407100 720100407400		BEDIENUNGSANLEITUNG GB SERVICE MANUAL D/GB SERVICE MANUAL D/GB 1.ERGAENZUNG SERVICE MANUAL D/GB 4.ERGAENZUNG	OPERATING INSTRUCTION GB SERVICE MANUAL D/GB SERVICE MANUAL D/GB 1ST SUPPLEMENT SERVICE MANUAL D/GB 4TH SUPPLEMENT
		297040133700	X	CHASSIS-FS-STEREO CUC 2121 GB DOLBY KEIN E-TEIL	CHASSIS TV STEREO CUC 2121 GB DOLBY NO SPARE PART
				X = SIEHE GESONDERTE E-LISTE	X = SEE SEPARATE PARTS LIST
		720100407100		ALLE WEITEREN TEILE SIEHE E-LISTE ST 55-734 GB/DOLBY MAT.-NR.: 921967639200 BESTELL-NR.: GCL7375GB AUSGABE 3/2001 VERSION NR.: VNM SIEHE SERVICE MANUAL D/GB 1.ERG.	FOR ALL OTHER PARTS SEE ST 55-734 GB/DOLBY PART NO.: 921967639200 ORDER NO.: GCL7375GB EDITION 3/2001 VERSION NO.: VNM SEE SERVICE MANUAL D/GB 1TH SUPPL.

Es gelten die Vorschriften und Sicherheitshinweise gemäß dem Service Manual "Sicherheit", Mat.-Nummer 720108000000, sowie zusätzlich die eventuell abweichenden, landesspezifischen Vorschriften!



The regulations and safety instructions shall be valid as provided by the "Safety" Service Manual, part number 720108000000, as well as the respective national deviations.

ÄNDERUNGEN VORBEHALTEN / SUBJECT TO ALTERATION

Ersatzteilliste
Spare Parts List

TV

3 / 2002

ST 55-934 GB/DOLBY

MATERIAL-NR. / PART NO.: 921932639200 BESTELL-NR. / ORDER NO.: GCL3175GB TITANE
VERSION NR./VERSION NO.: VNA

POS. NR. POS. NO.	ABB. FIG.	MATERIAL-NR. PART NUMBER	ANZ. QTY.	BEZEICHNUNG (D)	DESCRIPTION (GB)
		921932639200		ST 55-934 GB/DOLBY TITANE KEIN E-TEIL	ST 55-934 GB/DOLBY TITANE NO SPARE PART
0320.000 0700.000	△	291101516401 092461287510		TYPENAUFKLEBER VNA ENTMAGNETISIERUNGSSPULE	TYPE LABEL SELF ADHESIVE VNA COIL DEGAUSSING
		219329410100 720100407000 720100407100 720100407400		BEDIENUNGSANLEITUNG GB SERVICE MANUAL D/GB SERVICE MANUAL D/GB 1.ERGAENZUNG SERVICE MANUAL D/GB 4.ERGAENZUNG	OPERATING INSTRUCTIONS GB SERVICE MANUAL D/GB SERVICE MANUAL D/GB 1ST SUPPLEMENT SERVICE MANUAL D/GB 4TH SUPPLEMENT
		297040133100	X	CHASSIS-FS-STEREO CUC 2121 GB DOLBY KEIN E-TEIL X = SIEHE GESONDERTE E-LISTE	CHASSIS TV STEREO CUC 2121 GB DOLBY NO SPARE PART X = SEE SEPARATE PARTS LIST
		720100407100		ALLE WEITEREN TEILE SIEHE E-LISTE ST 55-934 GB/DOLBY MAT.-NR.: 921932639200 BESTELL-NR.: GCL3175 AUSGABE 3/2001 VERSION NR.: VNM SIEHE SERVICE MANUAL D/GB 1.ERG.	FOR ALL OTHER PARTS SEE ST 55-934 GB/DOLBY PART NO.: 921932639200 ORDER NO.: GCL3175 EDITION 3/2001 VERSION NO.: VNM SEE SERVICE MANUAL D/GB 1TH SUPPL.

Es gelten die Vorschriften und Sicherheitshinweise gemäß dem Service Manual "Sicherheit", Mat.-Nummer 720108000000, sowie zusätzlich die eventuell abweichenden, landesspezifischen Vorschriften!



The regulations and safety instructions shall be valid as provided by the "Safety" Service Manual, part number 720108000000, as well as the respective national deviations.

ÄNDERUNGEN VORBEHALTEN / SUBJECT TO ALTERATION

Ersatzteilliste
Spare Parts List

TV

3 / 2002

ST 55-934 GB/DOLBY

MATERIAL-NR. / PART NO.: 921932639200 BESTELL-NR. / ORDER NO.: GCL3175GB TITANE
VERSION NR./VERSION NO.: VNX

POS. NR. POS. NO.	ABB. FIG.	MATERIAL-NR. PART NUMBER	ANZ. QTY.	BEZEICHNUNG (D)	DESCRIPTION (GB)
		921932639200		ST 55-934 GB/DOLBY TITANE KEIN E-TEIL	ST 55-934 GB/DOLBY TITANE NO SPARE PART
0320.000 0700.000	△	291101516501 092461287510		TYPENAUFKLEBER VNX ENTMAGNETISIERUNGSSPULE	TYPE LABEL SELF ADHESIVE VNX COIL DEGAUSSING
		219329410100 720100407000 720100407100 720100407400		BEDIENUNGSANLEITUNG GB SERVICE MANUAL D/GB SERVICE MANUAL D/GB 1.ERGAENZUNG SERVICE MANUAL D/GB 4.ERGAENZUNG	OPERATING INSTRUCTIONS GB SERVICE MANUAL D/GB SERVICE MANUAL D/GB 1ST SUPPLEMENT SERVICE MANUAL D/GB 4TH SUPPLEMENT
		297040135200	X	CHASSIS-FS-STEREO CUC 2121 GB DOLBY KEIN E-TEIL X = SIEHE GESONDERTE E-LISTE	CHASSIS TV STEREO CUC 2121 GB DOLBY NO SPARE PART X = SEE SEPARATE PARTS LIST
		720100407100		ALLE WEITEREN TEILE SIEHE E-LISTE ST 55-934 GB/DOLBY MAT.-NR.: 921932639200 BESTELL-NR.: GCL3175 AUSGABE 3/2001 VERSION NR.: VNM SIEHE SERVICE MANUAL D/GB 1.ERG.	FOR ALL OTHER PARTS SEE ST 55-934 GB/DOLBY PART NO.: 921932639200 ORDER NO.: GCL3175 EDITION 3/2001 VERSION NO.: VNM SEE SERVICE MANUAL D/GB 1TH SUPPL.

Es gelten die Vorschriften und Sicherheitshinweise gemäß dem Service Manual "Sicherheit", Mat.-Nummer 720108000000, sowie zusätzlich die eventuell abweichenden, landesspezifischen Vorschriften!



The regulations and safety instructions shall be valid as provided by the "Safety" Service Manual, part number 720108000000, as well as the respective national deviations.

ÄNDERUNGEN VORBEHALTEN / SUBJECT TO ALTERATION

GRUNDIGErsatzteilliste
Spare Parts List**TV****3 / 2002****ST 55-934 GB/DOLBY**MATERIAL-NR. / PART NO.: 921932639200 BESTELL-NR. / ORDER NO.: GCL3175GB TITANE
VERSION NR./VERSION NO.: VNG

POS. NR. ABB. POS. NO. FIG.	MATERIAL-NR. PART NUMBER	ANZ. QTY.	BEZEICHNUNG (D)	DESCRIPTION (GB)
	921932639200		ST 55-934 GB/DOLBY TITANE KEIN E-TEIL	ST 55-934 GB/DOLBY TITANE NO SPARE PART
0320.000 0700.000	291101516601 092461287510	△	TYPENAUFKLEBER VNG ENTMAGNETISIERUNGSSPULE	TYPE LABEL SELF ADHESIVE VNG COIL DEGAUSSING
	219329410101 720100407000 720100407100 720100407400		BEDIENUNGSANLEITUNG GB SERVICE MANUAL D/GB SERVICE MANUAL D/GB 1.ERGAENZUNG SERVICE MANUAL D/GB 4.ERGAENZUNG	OPERATING INSTRUCTIONS GB SERVICE MANUAL D/GB SERVICE MANUAL D/GB 1ST SUPPLEMENT SERVICE MANUAL D/GB 4TH SUPPLEMENT
	297040137200	X	CHASSIS-FS-STEREO CUC 2121 GB DOLBY KEIN E-TEIL X = SIEHE GESONDERTE E-LISTE ALLE WEITEREN TEILE SIEHE E-LISTE ST 55-934 GB/DOLBY MAT.-NR.: 921932639200 BESTELL-NR.: GCL3175 AUSGABE 3/2001 VERSION NR.: VNM SIEHE SERVICE MANUAL D/GB 1.ERG.	CHASSIS TV STEREO CUC 2121 GB DOLBY NO SPARE PART X = SEE SEPARATE PARTS LIST FOR ALL OTHER PARTS SEE ST 55-934 GB/DOLBY PART NO.: 921932639200 ORDER NO.: GCL3175 EDITION 3/2001 VERSION NO.: VNM SEE SERVICE MANUAL D/GB 1TH SUPPL.
	720100407100			

Es gelten die Vorschriften und Sicherheitshinweise gemäß dem Service Manual "Sicherheit", Mat.-Nummer 720108000000, sowie zusätzlich die eventuell abweichenden, landesspezifischen Vorschriften!



The regulations and safety instructions shall be valid as provided by the "Safety" Service Manual, part number 720108000000, as well as the respective national deviations.

ÄNDERUNGEN VORBEHALTEN / SUBJECT TO ALTERATION

Ersatzteilliste Spare Parts List

12 / 2001

GRUNDIG

TV

CHASSIS-FS-MONO CUC 2103 INL CHASSIS TV MONO CUC 2103 INL

MATERIAL-NR. / PART NO.: 297040126500

POS. NR. POS. NO.	ABB. FIG.	MATERIAL-NR. PART NUMBER	ANZ. QTY.	BEZEICHNUNG (D)	DESCRIPTION (GB)
		297040126500		CHASSIS-FS-MONO CUC 2103 INL KEIN E-TEIL	CHASSIS TV MONO CUC 2103 INL NO SPARE PART
0100.000		295045010100		TUNER-PLL STEHEND	TUNER-PLL TOP ENTRY
0216.000		297033571100		TASTSCHALTER PROGRAMM+	KEY SWITCH PROGRAMME+
0216.000		297033571100		TASTSCHALTER PROGRAMM-	KEY SWITCH PROGRAMME-
0216.000		297033571100		TASTSCHALTER LAUTSTAERKE+	KEY SWITCH VOLUME+
0216.000		297033571100		TASTSCHALTER LAUTSTAERKE-	KEY SWITCH VOLUME-
0240.000		293033904300		KOPFHOERERBUCHSE 3,5 M.SCHALTER	HEADPHONE SOCKET 3,5 WITH SWITCH
0247.000		293031190603		EURO-AV BUCHSENLEISTE 21-POL SW	EURO-AV SOCKET STRIP 21 P BLACK
0910.000	△	292107030101		FOKUSLEITUNG	FOCUSING CABLE
1000.000	△	096211130206	2	SICHERUNGSHALTER SI62501	FUSE HOLDER SI62501
2000.000	△	297033910600		NETZSCHALTER O.WISCHER	POWER SWITCH W/O WISHER
2200.000	△	293033995100		NETZ EINBAUGERAETESTECKER	APPLIANCE COUPLER W.CABLE
2400.000	△	293031530208	2	MONTAGECLIP IC50010/T53001	MOUNTING CLIP IC50010/T53001
2410.000		293031531600		MONTAGECLIP T60506	MOUNTING CLIP T60506
2420.000		293031531605	3	MONTAGECLIP IC61040/61050/61060	MOUNTING CLIP IC61040/61050/61060
2450.000		293031562000	4	FOLIE WAERMELEITEND	FOIL HEAT CONDUCTING
				IC61040/61050/61060/T60506	IC61040/61050/61060/T60506
				WW.=WAHLWEISE	WW.=OPTIONAL

POS. NR. POS. NO.	MATERIAL-NR. PART NUMBER	BEZEICHNUNG DESCRIPTION	POS. NR. POS. NO.	MATERIAL-NR. PART NUMBER	BEZEICHNUNG DESCRIPTION
C 34026	845296706400	ELKO 1000UF +50-20% 10V	CT 34031	830100385800	SMD TRANS BC858B/ BC857B
C 50047	845299618700	ELKO 1000UF 20% 35V	CT 40581	830100385800	SMD TRANS BC858B/ BC857B
C 53002	851591167500	FOKO FKP1/4 7500PF 3,5% 1600V	CT 43010	830100385800	SMD TRANS BC858B/ BC857B
C 54011	865006704600	KERKO HV C 1000PF 20% 1KV	CT 43015	830100484800	SMD TRANS BC848B/ BC847B
C 60501	865008112500	KERKO HV C 1000PF 20% 1KV	CT 50005	830100484800	SMD TRANS BC848B/ BC847B
C 60509	851591104000	FOKO FKP1 220PF 10% 1600V	CT 50015	830100484800	SMD TRANS BC848B/ BC847B
C 60512	865008111100	KERKO HV C 270PF 20% 2KV	CT 50040	830100484800	SMD TRANS BC848B/ BC847B
C 60523	865008112500	KERKO HV C 1000PF 20% 1KV	CT 50050	830100484800	SMD TRANS BC848B/ BC847B
C 60524	865008112500	KERKO HV C 1000PF 20% 1KV	CT 50055	830100484800	SMD TRANS BC848B/ BC847B
C 60526	865008112500	KERKO HV C 1000PF 20% 1KV	CT 52260	830100385800	SMD TRANS BC858B/ BC857B
C 60527	865008112500	KERKO HV C 1000PF 20% 1KV	CT 57020	830100385800	SMD TRANS BC858B/ BC857B
C 61016	851591104000	FOKO FKP1 220PF 10% 1600V	CT 57021	830100385800	SMD TRANS BC858B/ BC857B
C 61036	865006704600	KERKO HV C 1000PF 20% 1KV	CT 57112	830100385800	SMD TRANS BC858B/ BC857B
C 61056	865006704600	KERKO HV C 1000PF 20% 1KV	CT 57113	830100385800	SMD TRANS BC858B/ BC857B
C 62501 △	851179301800	FOKO MP3 0,1UF 20% 275VW	CT 57124	830100484800	SMD TRANS BC848B/ BC847B
C 62503	856373242500	FOKO KF #25 0,1UF 20% 250VW	CT 61043	830100484800	SMD TRANS BC848B/ BC847B
C 62521 △	866009623800	KERKO SI 2200PF 20%	CT 61053	830100484800	SMD TRANS BC848B/ BC847B
C 62522 △	866009623800	KERKO SI 2200PF 20%	CT 81220	830100484800	SMD TRANS BC848B/ BC847B
C 62549 △	866009623400	KERKO SI 1000PF 20%	CT 81225	830100484800	SMD TRANS BC848B/ BC847B
C 81063	814054010400	EMIFIL 0,1 UF	CT 85502	830100385800	SMD TRANS BC858B/ BC857B
CD 80501	830940159200	SMD DIODE BA591/BA592/BA782S	D 40586	830921504500	DIODE 1N4148
CIC 80910	830581409400	SMD IC MC14094BD	D 43055	830921504500	DIODE 1N4148
CIC 80930	830595012900	SMD IC ST92R195C9Q1	D 43056	830921504500	DIODE 1N4148
CIC 82501	830596000800	SMD IC M24C08CM1TR	D 50023	830921502000	DIODE 1N4004
			D 50048	830970301400	Z-DIODE ZPY5,6 2%
			D 52001	830921504500	DIODE 1N4148
CT 32124	830100385800	SMD TRANS BC858B/ BC857B	D 53003	830920100500	DIODE BA157

ÄNDERUNGEN VORBEHALTEN / SUBJECT TO ALTERATION

POS. NR. POS. NO.	MATERIAL-NR. PART NUMBER	BEZEICHNUNG DESCRIPTION	POS. NR. POS. NO.	MATERIAL-NR. PART NUMBER	BEZEICHNUNG DESCRIPTION
D 54001	830920426800	DIODE BYV16	R 54022 △	870556110500	MOW 0617 22 KOHM 5% LI
D 54011	830920100500	DIODE BA157	R 60502	870006935600	KSW 0617 3 MOHM 2%
D 54022	830972033000	Z-DIODE 30 B 0,5W	R 60504	870006934700	KSW 0617 1,2 MOHM 2%
D 57013	830921504500	DIODE 1N4148	R 60508 △	870556110500	MOW 0617 22 KOHM 5% LI
D 57023	830921504500	DIODE 1N4148	R 60509 △	870556110500	MOW 0617 22 KOHM 5% LI
D 60506 △	830951685400	DIODE BYT 54 M	R 60516	879005004600	ESTR.SK10-A 4,7 KOHM LIN
D 60509 △	830966318000	Z-DIODE BZT03D180	R 61018 △	870552111900	MOW 0411 82 KOHM 5% LI
D 60512	830951675400	DIODE BYT53B	R 62501 △	831120001600	PTC DUO T251-A80-A10
D 60523	830856038400	GLR.SKB380C1500	R 62501 △	831120002000	PTC RM5 B59.250C1080
D 61016 △	830951717800	DIODE BYW178	R 62502	831100501700	NTC 4,7 OHM 30%
D 61036 △	830951717200	DIODE BYW172D	R 62549 △	876504916100	MSW SI 0414 4,7 MOHM VDE
D 61056 △	830951717200	DIODE BYW172D			
D 85001	830994460100	LE DIODE TLHR 4601	SI 62501 △	831561700600	SI 5X20 T2,5A L 250V
F 32109	860275652100	KERTRAP #521 5,5MHZ	T 52001	830328563700	TRANS.BC 637
F 32410	814110760100	SPULE 7X7 #601	T 53001	830290002000	TRANS S2055N/ BU508DF
F 32412	831900198400	OFWFL G1985M	T 60506	830226908900	TRANS BUZ90 TYPENGRUPPE B
F 34052	814111675000	FILTER 7X7 #750	TR 52001	092468680400	TRAFO TREIBER
IC 34015	830512524600	IC STV2246	TR 53000△	292016539702	DRIVER TRANSFORMER
IC 40560	830534726700	IC TDA7266L	TR 53000△	292016539702	DIODEN-SPLIT TRAFO
IC 50010	830533817500	IC TDA8174AW	TR 61000△	292015239701	DIODE SPLIT TRANSFORMER
IC 60510	830533464600	IC TDA16846			SPERRWANDLERTRAFO
IC 61040	830520431700	IC LM317T			REVERSE CONVERTER
IC 61050	830520431700	IC LM317T			TRANSFORMER
IC 61060	830520570300	IC MC7805CT			
IC 80500	830521006500	IC MC33164P-5RP			
IC 80920	297980210300	IC 27C020 PROG.KPL			
IC 81500	293052193300	PROZESSORPLATTE			
WW.	830415501300	IC ST92195C9B1-S213			
IC 84501	830546133000	IC TSOP1330			
L 31043	814052644000	DR ST 0411-GRP 8,2UH 10%			
L 32109	814052690600	DR 0309 4,7UH 10% ST			
L 41003	810498201400	DAEMPF-PERLE 433003038102 DAMPING BEAD			
L 52251	814051174900	DR AX 0411-GA 10UH 10%			
L 52256	814052632000	DR AX 0411-GA 3,3UH 10%			
L 53003	810498205600	FERRITPERLE HF70 BTL 3,5X6			
L 61016	810498200300	FERRITPERLE BL02RN2-R62			
L 61038	810498200300	FERRITPERLE BL02RN2-R62 FERRITE BEAD			
L 62501 △	295008269700	FUNKENTSTOERDROSSEL RK19 INTERFERENCE SUPPR. CHOKE			
L 81061	810498205100	FERRITPERLE HF55 BTL 3,5X4,5 FERRITE BEAD			
L 81062	814052636100	DR 0411 10UH 5%			
L 81064	814052636100	DR 0411 10UH 5%			
Q 34043	838212104400	QUARZ 4,433619 MHZ			
Q 80001	838208004000	QUARZ 4 MHZ			
Q 80951	838216204100	QUARZ 4 MHZ			
R 40553 △	870111901700	KSW SI B 4,7 OHM 5%			
R 43006	870001124600	KSW 0204 75 OHM 5%			
R 50047	876644260600	MSW 0207 1,6 OHM 1% ST			
R 50048 △	870552103300	MOW 0411 22 OHM 5% LI			
R 50050 △	870522705300	MOW 0411 150 OHM 5%			
R 52004 △	870552103500	MOW 0411 27 OHM 5% LI			
R 52006	870522699000	MOW 0411 0,47 OHM 5%			
R 53002 △	870042909700	KSW NB 0207 10 KOHM 5% ST			
R 53009	871033814500	MGW AX 1 MOHM 5%			
R 53016	873017922500	DRW 7 10 OHM 10% ST			
R 53033 △	870552101300	MOW 0411 3,3 OHM 5% LI			
R 54001 △	870552102500	MOW 0411 10 OHM 5% LI			
R 54006 △	870552100900	MOW 0411 2,2 OHM 5% LI			

Es gelten die Vorschriften und Sicherheitshinweise gemäß dem Service Manual "Sicherheit", Mat.-Nummer 720108000000, sowie zusätzlich die eventuell abweichenden, landesspezifischen Vorschriften!



The regulations and safety instructions shall be valid as provided by the "Safety" Service Manual, part number 720108000000, as well as the respective national deviations.

ÄNDERUNGEN VORBEHALTEN / SUBJECT TO ALTERATION

Ersatzteilliste
Spare Parts List

12 / 2001

CHASSIS-FS-MONO CUC 2103 M
CHASSIS TV MONO CUC 2103 M

MATERIAL-NR. / PART NO.: 297040126700

POS. NR. POS. NO.	ABB. FIG.	MATERIAL-NR. PART NUMBER	ANZ. QTY.	BEZEICHNUNG (D)	DESCRIPTION (GB)
		297040126700		CHASSIS-FS-MONO CUC 2103 M KEIN E-TEIL	CHASSIS TV MONO CUC 2103 M NO SPARE PART
0100.000		295045010100		TUNER-PLL STEHEND	TUNER-PLL TOP ENTRY
0216.000		297033571100		TASTSCHALTER PROGRAMM+	KEY SWITCH PROGRAMME+
0216.000		297033571100		TASTSCHALTER PROGRAMM-	KEY SWITCH PROGRAMME-
0216.000		297033571100		TASTSCHALTER LAUTSTAEERKE+	KEY SWITCH VOLUME+
0216.000		297033571100		TASTSCHALTER LAUTSTAEERKE-	KEY SWITCH VOLUME-
0240.000		293033904300		KOPFHOERERBUCHSE 3,5 M.SCHALTER	HEADPHONE SOCKET 3,5 WITH SWITCH
0247.000		293031190603		EURO-AV BUCHSENLEISTE 21-POL SW	EURO-AV SOCKET STRIP 21 P BLACK
0910.000	△	292107030101		FOKUSLEITUNG	FOCUSING CABLE
1000.000	△	096211130206	2	SICHERUNGSHALTER Si62501	FUSE HOLDER Si62501
2000.000	△	297033910600		NETZSCHALTER O.WISCHER	POWER SWITCH W/O WIPER
2200.000	△	293033995100		NETZ EINBAUGERAETESTECKER	APPLIANCE COUPLER W.CABLE
2400.000		293031530208	2	MONTAGECLIP IC50010/T53001	MOUNTING CLIP IC50010/T53001
2410.000		293031531600		MONTAGECLIP T60506	MOUNTING CLIP T60506
2420.000		293031531605	3	MONTAGECLIP IC61040/61050/61060	MOUNTING CLIP IC61040/61050/61060
2450.000		293031562000	4	FOLIE WAERMELEITEND IC61040/61050/61060/T60506	FOIL HEAT CONDUCTING IC61040/61050/61060/T60506
				WW.=WAHLWEISE	WW.=OPTIONAL

POS. NR. POS. NO.	MATERIAL-NR. PART NUMBER	BEZEICHNUNG DESCRIPTION	POS. NR. POS. NO.	MATERIAL-NR. PART NUMBER	BEZEICHNUNG DESCRIPTION
C 34026	845296706400	ELKO 1000UF +50-20% 10V	CIC 80930	830595012900	SMD IC ST92R195C9Q1
C 50047	845299618700	ELKO 1000UF 20% 35V	CIC 82501	830596000800	SMD IC M24C08CM1TR
C 53002	851591167500	FOKO FKP1/4 7500PF 3,5% 1600V	CT 32111	830100484800	SMD TRANS BC848B/ BC847B
C 54011	865006704600	KERKO HV C 1000PF 20% 1KV	CT 32122	830100385800	SMD TRANS BC858B/ BC857B
C 60501	865008112500	KERKO HV C 1000PF 20% 1KV	CT 32123	830100484800	SMD TRANS BC848B/ BC847B
C 60509	851591104000	FOKO FKP1 220PF 10% 1600V	CT 32124	830100385800	SMD TRANS BC858B/ BC857B
C 60512	865008111100	KERKO HV C 270PF 20% 2KV	CT 32132	830100484800	SMD TRANS BC848B/ BC847B
C 60523	865008112500	KERKO HV C 1000PF 20% 1KV	CT 32460	830100484800	SMD TRANS BC848B/ BC847B
C 60524	865008112500	KERKO HV C 1000PF 20% 1KV	CT 32470	830100484800	SMD TRANS BC848B/ BC847B
C 60526	865008112500	KERKO HV C 1000PF 20% 1KV	CT 32480	830100484800	SMD TRANS BC848B/ BC847B
C 60527	865008112500	KERKO HV C 1000PF 20% 1KV	CT 34031	830100385800	SMD TRANS BC858B/ BC857B
C 61016	851591104000	FOKO FKP1 220PF 10% 1600V	CT 40581	830100385800	SMD TRANS BC858B/ BC857B
C 61036	865006704600	KERKO HV C 1000PF 20% 1KV	CT 43010	830100385800	SMD TRANS BC858B/ BC857B
C 61056	865006704600	KERKO HV C 1000PF 20% 1KV	CT 43015	830100484800	SMD TRANS BC848B/ BC847B
C 62501	851179301800	FOKO MP3 0,1UF 20% 275VW	CT 50005	830100484800	SMD TRANS BC848B/ BC847B
C 62503	856373242500	FOKO KF #25 0,1UF 20% 250VW	CT 50015	830100484800	SMD TRANS BC848B/ BC847B
C 62521	866009623800	KERKO SI 2200PF 20%	CT 50040	830100484800	SMD TRANS BC848B/ BC847B
C 62522	866009623800	KERKO SI 2200PF 20%	CT 50050	830100484800	SMD TRANS BC848B/ BC847B
C 62549	866009623400	KERKO SI 1000PF 20%	CT 50055	830100484800	SMD TRANS BC848B/ BC847B
C 81063	814054010400	EMFIL 0,1 UF	CT 52260	830100385800	SMD TRANS BC858B/ BC857B
CD 32411	830940159200	SMD DIODE BA591/BA592/BA782S	CT 57020	830100385800	SMD TRANS BC858B/ BC857B
CD 32460	830940159200	SMD DIODE BA591/BA592/BA782S	CT 57021	830100385800	SMD TRANS BC858B/ BC857B
CD 32470	830940159200	SMD DIODE BA591/BA592/BA782S	CT 57112	830100385800	SMD TRANS BC858B/ BC857B
CD 34041	830940159200	SMD DIODE BA591/BA592/BA782S	CT 57113	830100385800	SMD TRANS BC858B/ BC857B
CD 80501	830940159200	SMD DIODE BA591/BA592/BA782S	CT 57114	830100484800	SMD TRANS BC848B/ BC847B
CIC 80910	830581409400	SMD IC MC14094BD	CT 61043	830100484800	SMD TRANS BC848B/ BC847B
			CT 61053	830100484800	SMD TRANS BC848B/ BC847B

ÄNDERUNGEN VORBEHALTEN / SUBJECT TO ALTERATION

GRUNDIG

TV

POS. NR. POS. NO.	MATERIAL-NR. PART NUMBER	BEZEICHNUNG DESCRIPTION
CT 81220	830100484800	SMD TRANS BC848B/ BC847B
CT 81225	830100484800	SMD TRANS BC848B/ BC847B
CT 85502	830100385800	SMD TRANS BC858B/ BC857B
D 40586	830921504500	DIODE 1N4148
D 43055	830921504500	DIODE 1N4148
D 43056	830921504500	DIODE 1N4148
D 50023	830921502000	DIODE 1N4004
D 50048	830970301400	Z-DIODE ZPY5,6 2%
D 52001	830921504500	DIODE 1N4148
D 53003	830920100500	DIODE BA157
D 54001	830920426800	DIODE BYV16
D 54011	830920100500	DIODE BA157
D 54022	830972033000	Z-DIODE 30 B 0,5W
D 57013	830921504500	DIODE 1N4148
D 57023	830921504500	DIODE 1N4148
D 60506	830951685400	DIODE BYT 54 M
D 60509	830966318000	Z-DIODE BZT03D180
D 60512	830951675400	DIODE BYT53B
D 60523	830856038400	GLR.SKB380C1500
D 61016	830951717800	DIODE BYW178
D 61036	830951717200	DIODE BYW172D
D 61056	830951717200	DIODE BYW172D
D 85001	830994460100	LE DIODE TLHR 4601
F 32109	860275506600	KERTRAP #66 5,5/6/6,5MHZ
F 32121	814111136000	FILTER 7X7 360
F 32410	814053445100	SPLULE 7X7 #451
F 32412	831900629000	OFWIFIL K6290K
F 32430	831900945300	OFW L9453
F 34052	814111675000	FILTER 7X7 #750
IC 34015	830512524800	IC STV2248
IC 40560	830534726700	IC TDA7266L
IC 50010	830533817500	IC TDA8174AW
IC 60510	830533464600	IC TDA16846
IC 61040	830520431700	IC LM317T
IC 61050	830520431700	IC LM317T
IC 61060	830520570300	IC MC7805CT
IC 80500	830521006500	IC MC33164P-5RP
IC 80920	297980210300	IC 27C020 PROG.KPL
IC 81500	293052193300	PROZESSORPLATTE
WW.	830415501300	IC ST92195C9B1-S213
IC 84501	830546133000	IC TSOP1330
L 31043	814052644000	DR ST 0411-GRP 8,2UH 10%
L 32109	814052690600	DR 0309 4,7UH 10% ST
L 41003	810498201400	DAEMPF-PERLE 433003038102 DAMPING BEAD
L 52251	814051174900	DR AX 0411-GA 10UH 10%
L 52256	814052632000	DR AX 0411-GA 3,3UH 10%
L 53003	810498205600	FERRITPERLE HF70 BTL 3,5X6
L 61016	810498200300	FERRITPERLE BL02RN2-R62
L 61038	810498200300	FERRITPERLE BL02RN2-R62
L 62501	295008269700	FUNKENTSTOERDROSSEL RK19 INTERFERENCE SUPPR. CHOKE
L 81061	810498205100	FERRITPERLE HF55 BTL 3,5X4,5 FERRITE BEAD
L 81062	814052636100	DR 0411 10UH 5%
L 81064	814052636100	DR 0411 10UH 5%
Q 34043	838212104400	QUARZ 4,433619 MHZ
Q 34044	838204900300	QUARZ 3,579545MHZ
Q 80001	838208004000	QUARZ 4 MHZ
Q 80951	838216204100	QUARZ 4 MHZ

Es gelten die Vorschriften und Sicherheitshinweise gemäß dem Service Manual "Sicherheit", Mat.-Nummer 720108000000, sowie zusätzlich die eventuell abweichenden, landesspezifischen Vorschriften!



The regulations and safety instructions shall be valid as provided by the "Safety" Service Manual, part number 720108000000, as well as the respective national deviations.

ÄNDERUNGEN VORBEHALTEN / SUBJECT TO ALTERATION

Ersatzteilliste
Spare Parts List

3 / 2002

CHASSIS-FS-MONO CUC 2105 M/BAT
CHASSIS TV MONO CUC 2105 M/BAT

MATERIAL-NR. / PART NO.: 297040125900

Table with 5 columns: POS. NR., ABB., MATERIAL-NR., ANZ., BEZEICHNUNG, DESCRIPTION. Lists various electronic components like tuners, switches, and cables.

Table with 5 columns: POS. NR., MATERIAL-NR., BEZEICHNUNG, POS. NR., MATERIAL-NR., BEZEICHNUNG. Lists components like capacitors, diodes, and transistors.

ÄNDERUNGEN VORBEHALTEN / SUBJECT TO ALTERATION

Table with 5 columns: POS. NR., MATERIAL-NR., BEZEICHNUNG, POS. NR., MATERIAL-NR., BEZEICHNUNG. Lists components like resistors, capacitors, and diodes.

Es gelten die Vorschriften und Sicherheitshinweise gemäß dem Service Manual "Sicherheit", Mat.-Nummer 720108000000, sowie zusätzlich die eventuell abweichenden, landesspezifischen Vorschriften!



The regulations and safety instructions shall be valid as provided by the "Safety" Service Manual, part number 720108000000, as well as the respective national deviations.

ÄNDERUNGEN VORBEHALTEN / SUBJECT TO ALTERATION

Ersatzteilliste
Spare Parts List

3 / 2002

CHASSIS-FS-MONO CUC 2105 M/BAT/SAT
CHASSIS TV MONO CUC 2105 M/BAT/SAT

MATERIAL-NR. / PART NO.: 297040126000

POS. NR. POS. NO.	ABB. FIG.	MATERIAL-NR. PART NUMBER	ANZ. QTY.	BEZEICHNUNG (D)	DESCRIPTION (GB)
		297040126000		CHASSIS-FS-MONO CUC 2105 M/BAT/SAT KEIN E-TEIL	CHASSIS TV MONO CUC 2105 M/BAT/SAT NO SPARE PART
0100.000		295045010100		TUNER-PLL STEHEND	TUNER-PLL TOP ENTRY
0216.000		297033571100		TASTSCHALTER PROGRAMM+	KEY SWITCH PROGRAMME+
0216.000		297033571100		TASTSCHALTER PROGRAMM-	KEY SWITCH PROGRAMME-
0216.000		297033571100		TASTSCHALTER LAUTSTAERKE+	KEY SWITCH VOLUME+
0216.000		297033571100		TASTSCHALTER LAUTSTAERKE-	KEY SWITCH VOLUME-
0240.000		293033904300		KOPFHOERERBUCHSE 3,5 M.SCHALTER	HEADPHONE SOCKET 3,5 WITH SWITCH
0247.000		293031196603		EURO-AV BUCHSENLEISTE 21-POL.SW	EURO-AV SOCKET STRIP 21 P BLACK
0312.000		297006432402		ABDECKUNG 12V/SAT	COVER 12V/SAT
0405.000		293050073400	X	BAUSTEIN NETZTEIL 12V	MODULE POWER SUPPLY 12V
0910.000	△	292107030100		FOKUSLEITUNG	FOCUSING CABLE
1000.000	△	096211130206	2	SICHERUNGSHALTER SI62501	FUSE HOLDER SI62501
1100.000		295041062900	X	BAUSTEIN SAT (SER 2001)	MODULE SAT (SER 2001)
2000.000	△	297033910900		NETZSCHALTER O.WISCHER	POWER SWITCH W/O WIPER
2400.000		293031530208	2	MONTAGECLIP IC50010/T53001	MOUNTING CLIP IC50010/T53001
2410.000		293031531600		MONTAGECLIP T60506	MOUNTING CLIP T60506
2420.000		293031531605	3	MONTAGECLIP IC61040/61050/61060	MOUNTING CLIP IC61040/61050/61060
2450.000		293031562000	4	FOLIE WAERMELEITEND IC61040/61050/61060/T60506	FOIL HEAT CONDUCTING IC61040/61050/61060/T60506
				WW.=WAHLWEISE X=SIEHE GESONDERTE E-LISTE	WW.=OPTIONAL X=SEE SEPARATE PARTS LIST

POS. NR. POS. NO.	MATERIAL-NR. PART NUMBER	BEZEICHNUNG DESCRIPTION	POS. NR. POS. NO.	MATERIAL-NR. PART NUMBER	BEZEICHNUNG DESCRIPTION
C 34026	845296706400	ELKO 1000UF +50-20% 10V	CIC 80910	830581409400	SMD IC MC14094BD
C 50047	845299868700	ELKO 1000UF 20% 35V	CIC 80930	830595012900	SMD IC ST92R195C9Q1
C 53002	851591167500	FOKO FKP1/4 7500PF 3,5% 1600V	CIC 82501	830596000800	SMD IC M24C08CM1TR
C 54011	865006704600	KERKO HV C 1000PF 20% 1KV	CL 40511	810498233100	SMD DAEMPF-PERLE 0805
C 60501	865008112500	KERKO HV C 1000PF 20% 1KV	CT 32111	830100484800	SMD TRANS BC848B/ BC847B
C 60509	851591104000	FOKO FKP1 220PF 10% 1600V	CT 32122	830100385800	SMD TRANS BC858B/ BC857B
C 60512	865008111100	KERKO HV C 270PF 20% 2KV	CT 32123	830100484800	SMD TRANS BC848B/ BC847B
C 60523	865008112500	KERKO HV C 1000PF 20% 1KV	CT 32124	830100385800	SMD TRANS BC858B/ BC857B
C 60524	865008112500	KERKO HV C 1000PF 20% 1KV	CT 32132	830100484800	SMD TRANS BC848B/ BC847B
C 60526	865008112500	KERKO HV C 1000PF 20% 1KV	CT 32133	830100484800	SMD TRANS BC848B/ BC847B
C 60527	865008112500	KERKO HV C 1000PF 20% 1KV	CT 32460	830100484800	SMD TRANS BC848B/ BC847B
C 60528	845209711500	ELKO SNT #40 150UF 385V/400V	CT 32470	830100484800	SMD TRANS BC848B/ BC847B
WW.	845199711500	ELKO 19 150UF 385V	CT 32480	830100484800	SMD TRANS BC848B/ BC847B
C 61016	851591104000	FOKO FKP1 220PF 10% 1600V	CT 34031	830100385800	SMD TRANS BC858B/ BC857B
C 61036	865006704600	KERKO HV C 1000PF 20% 1KV	CT 40581	830100385800	SMD TRANS BC858B/ BC857B
C 62501	851179301800	FOKO MP3 0,1UF 20% 275VW	CT 43010	830100385800	SMD TRANS BC858B/ BC857B
C 62502	851179301800	FOKO MP3 0,1UF 20% 275VW	CT 43015	830100484800	SMD TRANS BC848B/ BC847B
C 62521	866009623800	KERKO SI 2200PF 20%	CT 50005	830100484800	SMD TRANS BC848B/ BC847B
C 62522	866009623800	KERKO SI 2200PF 20%	CT 50015	830100484800	SMD TRANS BC848B/ BC847B
C 62549	866009623400	KERKO SI 1000PF 20%	CT 50040	830100484800	SMD TRANS BC848B/ BC847B
C 81063	814054010400	EMIFIL 0,1 UF	CT 50050	830100484800	SMD TRANS BC848B/ BC847B
CD 32411	830940159200	SMD DIODE BA591/BA592/BA782S	CT 50055	830100484800	SMD TRANS BC848B/ BC847B
CD 32460	830940159200	SMD DIODE BA591/BA592/BA782S	CT 52260	830100385800	SMD TRANS BC858B/ BC857B
CD 32470	830940159200	SMD DIODE BA591/BA592/BA782S	CT 57020	830100385800	SMD TRANS BC858B/ BC857B
CD 34041	830940159200	SMD DIODE BA591/BA592/BA782S	CT 57021	830100385800	SMD TRANS BC858B/ BC857B
CD 80501	830940159200	SMD DIODE BA591/BA592/BA782S	CT 57112	830100385800	SMD TRANS BC858B/ BC857B

GRUNDIG

TV

POS. NR. POS. NO.	MATERIAL-NR. PART NUMBER	BEZEICHNUNG DESCRIPTION
CT 57113	830100385800	SMD TRANS BC858B/ BC857B
CT 57124	830100484800	SMD TRANS BC848B/ BC847B
CT 61043	830100484800	SMD TRANS BC848B/ BC847B
CT 61053	830100484800	SMD TRANS BC848B/ BC847B
CT 81220	830100484800	SMD TRANS BC848B/ BC847B
CT 81225	830100484800	SMD TRANS BC848B/ BC847B
CT 85502	830100385800	SMD TRANS BC858B/ BC857B
D 40586	830921504500	DIODE 1N4148
D 43055	830921504500	DIODE 1N4148
D 43056	830921504500	DIODE 1N4148
D 50023	830921502000	DIODE 1N4004
D 50048	830970301400	Z-DIODE ZPY5,6 2%
D 52001	830921504500	DIODE 1N4148
D 53003	830920100500	DIODE BA157
D 54001	830920426800	DIODE BYV16
D 54011	830920100500	DIODE BA157
D 54022	830972033000	Z-DIODE 30 B 0,5W
D 57013	830921504500	DIODE 1N4148
D 57023	830921504500	DIODE 1N4148
D 60506	830951685400	DIODE BYT 54 M
D 60509	830966318000	Z-DIODE BZT03D180
D 60512	830951675400	DIODE BYT53B
D 60523	830856038400	GLR.SKB380C1500
D 61016	830951717800	DIODE BYW178
D 61037	830951710800	DIODE BYT108-400
D 85511	830994460100	LE DIODE TLHR 4601
F 32109	860275506600	KERTRAP #66 5,5/6/6,5MHZ
F 32121	814111136000	FILTER 7X7 360
F 32410	814053445100	SPLICE 7X7 #451
F 32412	831900629000	OFW/FIL K6290K
F 32430	831900945300	OFW L9453
F 34052	814111675000	FILTER 7X7 #750
IC 34015	830512524800	IC STV2248
IC 40560	830534726700	IC TDA7266L
IC 50010	830533817500	IC TDA8174AW
IC 60510	830533464600	IC TDA16846
IC 61040	830520431700	IC LM317T
IC 61050	830520431700	IC LM317T
IC 61060	830520570300	IC MC7805CT
IC 80500	830521006500	IC MC33164P-5RP
IC 80920	297980170400	297980170400
IC 81500	293052192100	PROZESSORPLATTE
IC 84501	830546133000	IC TSOP1330
L 31043	814052644000	DR ST 0411-GRP 8,2UH 10%
L 32109	814052690600	DR 0309 4,7UH 10% ST
L 40512	814050525900	DR A AX-GA 27UH 10%
L 41003	810498201400	DAEMPF-PERLE 433003038102 DAMPING BEAD
L 52251	814051174900	DR AX 0411-GA 10UH 10%
L 52256	814052632000	DR AX 0411-GA 3,3UH 10%
L 53003	810498205600	FERRITPERLE HF70 BTL 3,5X6
L 61016	810498200300	FERRITPERLE BL02RN2-R62
L 61038	810498200300	FERRITPERLE BL02RN2-R62 FERRITE BEAD
L 62501	295008269700	FUNKENTSTOERDROSSEL RK19 INTERFERENCE SUPPR. CHOKE
L 81061	810498205100	FERRITPERLE HF55 BTL 3,5X4,5 FERRITE BEAD
L 81062	814052636100	DR 0411 10UH 5%
L 81064	814052636100	DR 0411 10UH 5%
Q 34043	838212104400	QUARZ 4,433619 MHZ

POS. NR. POS. NO.	MATERIAL-NR. PART NUMBER	BEZEICHNUNG DESCRIPTION
Q 34044	838204900300	QUARZ 3,579545MHZ
Q 80001	838208004000	QUARZ 4 MHZ
Q 80951	838216204100	QUARZ 4 MHZ
R 40553	870111901700	KSW SI B 4,7 OHM 5% ST
R 43006	870001124600	KSW 0204 75 OHM 5%
R 50047	876642460600	MSW 0207 1,6 OHM 1% ST
R 50048	870552103300	MOW 0411 22 OHM 5% LI
R 50050	870522705300	MOW 0411 150 OHM 5%
R 52004	870552103500	MOW 0411 27 OHM 5% LI
R 52006	870522699000	MOW 0411 0,47 OHM 5%
R 53002	870042909700	KSW NB 0207 10 KOHM 5% ST
R 53009	871033814500	MGW AX 1 MOHM 5%
R 53016	873017922500	DRW 7 10 OHM 10% ST
R 53033	870552101300	MOW 0411 3,3 OHM 5% LI
R 54001	870552102500	MOW 0411 10 OHM 5% LI
R 54006	870552100900	MOW 0411 2,2 OHM 5% LI
R 54022	870556110500	MOW 0617 22 KOHM 5% LI
R 60502	870006935600	KSW 0617 3 MOHM 2%
R 60504	870006934700	KSW 0617 1,2 MOHM 2%
R 60508	870556110500	MOW 0617 22 KOHM 5% LI
R 60509	870556110500	MOW 0617 22 KOHM 5% LI
R 60516	870005004600	ESTR.SK10-A 4,7 KOHM LIN
R 61018	870552111900	MOW 0411 82 KOHM 5% LI
R 62502	831100501700	NTC 4,7 OHM 30%
R 62503	876504915700	MSW SI 0414 3,3 MOHM VDE
R 62549	876504916100	MSW SI 0414 4,7 MOHM VDE
SI 62501	831561700600	SI 5X20 T2,5A L 250V
T 52001	830328563700	TRANS.BC 637
T 53001	830290002000	TRANS S2055N/ BU508DF
T 60506	830226908900	TRANS BU290 TYPENGRUPPE B
TR 52001	092468680400	TRAFO TREIBER DRIVER TRANSFORMER
TR 53000	292016539702	DIODEN-SPLIT TRAFO DIODE SPLIT TRANSFORMER
TR 61000	292015239701	SPERRWANDLERTRAFO REVERSE CONVERTER TRANSFORMER

Es gelten die Vorschriften und Sicherheitshinweise gemäß dem Service Manual "Sicherheit", Mat.-Nummer 720108000000, sowie zusätzlich die eventuell abweichenden, landesspezifischen Vorschriften!



The regulations and safety instructions shall be valid as provided by the "Safety" Service Manual, part number 720108000000, as well as the respective national deviations.

ÄNDERUNGEN VORBEHALTEN / SUBJECT TO ALTERATION

ÄNDERUNGEN VORBEHALTEN / SUBJECT TO ALTERATION

Ersatzteilliste Spare Parts List

11 / 2000

CHASSIS-FS-STEREO CUC 2121/INL/DOLBY CHASSIS TV STEREO CUC 2121/INL/DOLBY

MATERIAL-NR. / PART NO.: 297040130100

POS. NR. POS. NO.	ABB. FIG.	MATERIAL-NR. PART NUMBER	ANZ. QTY.	BEZEICHNUNG (D)	DESCRIPTION (GB)
		297040130100		CHASSIS-FS-STEREO CUC 2121/INL/DOLBY KEIN E-TEIL	CHASSIS TV STEREO CUC 2121/INL/DOLBY NO SPARE PART
0100.000 0216.000 0216.000 0216.000 0216.000 0240.000 0241.000 0247.000 0312.000 0500.000 0910.000 1000.000 2000.000 2200.000 2410.000 2420.000 2440.000 2445.000 2470.000	△ △ △ △ △ △ △ △ △ △ △ △ △ △ △ △ △ △ △	295043010100 297033571100 297033571100 297033571100 297033571100 293033904200 293031680503 293031190602 297006430104 295041028300 292107030101 096211130206 297033910600 293033995100 293031530208 293031530304 293031531600 293031531605 293031562000	X 2 2 3 4	TUNER-GLOBAL (PLL) TASTSCHALTER PROGRAMM + TASTSCHALTER PROGRAMM - TASTSCHALTER LAUTSTÄERKE + TASTSCHALTER LAUTSTÄERKE - KOPFHÖRERBUCHSE 3,5mm O.SCHALTER CINCH-BUCHSE 3-FACH FBAS/NF L,R EURO-AV BUCHSENLEISTE 21-POL SW ABDECKUNG EURO-AV BAUSTEIN STEREO MODUL FOKUSLEITUNG 2 SICHERUNGSHALTER Si62501 NETZSCHALTER O.WISCHER NETZ EINBAUGERÄTESTECKER 2 MONTAGECLIP IC40550/TS3001 MONTAGECLIP IC50010 MONTAGECLIP T60506 3 MONTAGECLIP IC61040/61050/61060 4 FOLIE WAERMELEITEND IC61040/ 61050/61060/T60506	TUNER-GLOBAL (PLL) KEY SWITCH PROGRAMME + KEY SWITCH PROGRAMME - KEY SWITCH VOLUME + KEY SWITCH VOLUME - HEADPHONE SOCKET 3,5mm W/O SWITCH CINCH SOCKET 3 FOLD FBAS/AF L,R EURO-AV SOCKET STRIP 21 PIN BLACK COVER EURO AV MODULE STEREO FOCUSING CABLE FUSE HOLDER SI62501 POWER SWITCH W/O WIPER APPLIANCE COUPLER MOUNTING CLIP IC40550/TS3001 MOUNTING CLIP IC50010 MOUNTING CLIP T60506 MOUNTING CLIP IC61040/61050/61060 FOIL HEAT CONDUCTING IC61040/ 61050/61060/T60506

X = SIEHE GESONDERTE E-LISTE

X = SEE SEPARATE PARTS LIST

POS. NR. POS. NO.	MATERIAL-NR. PART NUMBER	BEZEICHNUNG DESCRIPTION	POS. NR. POS. NO.	MATERIAL-NR. PART NUMBER	BEZEICHNUNG DESCRIPTION
C 34026 C 40557 C 50047 C 53002 C 54011 C 54012 C 60501 C 60509 C 60512 C 60523 C 60524 C 60526 C 60527 C 61036 C 61056 C 62501 C 62521 C 62522 C 62548 C 81063 CD 80501	845296706400 845299610700 845299618700 851591111400 865006704600 845299618700 865008112500 851591104500 865008111100 865008112500 865008112500 865008112500 865008112500 865006704600 865006704600 851179301800 866009623800 866009623800 866009623400 814054010400 830940159200	ELKO 1000UF 10V ELKO 2200UF 20% 16V ELKO 1000UF 20% 35V FOKO KF #35 9000PF 3,5% 1500V KERKO HV C 100PF 20% 1KV ELKO 1000UF 20% 35V KERKO HV C 1000PF 20% 1KV FOKO FKP1 680PF 10% 1600V KERKO HV C 270PF 20% 2KV KERKO HV C 1000PF 20% 1KV KERKO HV C 1000PF 20% 1KV KERKO HV C 1000PF 20% 1KV KERKO HV C 1000PF 20% 1KV KERKO HV C 100PF 20% 1KV KERKO HV C 100PF 20% 1KV MP3 0,1UF 20% 250V KERKO SI 2200PF 20% KERKO SI 2200PF 20% KERKO SI 1000PF 20% EMIFIL 0,1 UF -GR SMD DIODE BA591	CIC82501 CT 32124 CT 34031 CT 40581 CT 43010 CT 43015 CT 50005 CT 50015 CT 50040 CT 50050 CT 50055 CT 52260 CT 57020 CT 57021 CT 57112 CT 57113 CT 57124 CT 61043 CT 61053 CT 81220 CT 81225	830596000800 830100385800 830100385800 830100385800 830100385800 830100484800 830100484800 830100484800 830100484800 830100484800 830100484800 830100385800 830100385800 830100385800 830100385800 830100385800 830100385800 830100484800 830100484800 830100484800 830100484800 830100484800 830100484800	SMD IC M24C08CM1TR SMD TRANS BC858B/BC857B SMD TRANS BC858B/BC857B SMD TRANS BC858B/BC857B SMD TRANS BC858B/BC857B SMD TRANS BC848B/BC847B SMD TRANS BC848B/BC847B SMD TRANS BC848B/BC847B SMD TRANS BC848B/BC847B SMD TRANS BC848B/BC847B SMD TRANS BC848B/BC847B SMD TRANS BC858B/BC857B SMD TRANS BC858B/BC857B SMD TRANS BC858B/BC857B SMD TRANS BC858B/BC857B SMD TRANS BC858B/BC857B SMD TRANS BC858B/BC857B SMD TRANS BC848B/BC847B SMD TRANS BC848B/BC847B SMD TRANS BC848B/BC847B SMD TRANS BC848B/BC847B SMD TRANS BC848B/BC847B SMD TRANS BC848B/BC847B

ÄNDERUNGEN VORBEHALTEN / SUBJECT TO ALTERATION

GRUNDIG

TV

POS. NR. POS. NO.	MATERIAL-NR. PART NUMBER	BEZEICHNUNG DESCRIPTION	POS. NR. POS. NO.	MATERIAL-NR. PART NUMBER	BEZEICHNUNG DESCRIPTION
CT 85502	830100385800	SMD TRANS BC858B/BC857B	Q 80001	838208004000	QUARZ 4 MHZ
D 40584 D 40586 D 43055 D 43056 D 50023 D 50048 D 52001 D 53003 D 54001 D 54011 D 54022 D 57013 D 57023 D 60506 D 60509 D 60512 D 60523 D 61016 D 61036 D 61056 D 85001	830921504500 830921504500 830921504500 830921502000 830970301600 830921504500 830920100500 830920426800 830920100500 830970713500 830921504500 830921504500 830951685400 830966318000 830951675400 830856038400 830951717800 830951710800 830951717200 830994460100	DIODE 1N4148 DIODE 1N4148 DIODE 1N4148 DIODE 1N4148 DIODE 1N4004 Z-DIODE ZPY6,2 2% DIODE 1N4148 DIODE BA157 DIODE BYV16 DIODE BA157 Z DIODE 33B 0,5W DIODE 1N4148 DIODE 1N4148 DIODE BYT54M Z-DIODE BZT03D180 DIODE BYT53B GLR.SKB380C1500 DIODE BYW178 DIODE BYT108-400 DIODE BYW172D LE DIODE TLHR4601	F 32109 F 32410 F 32412 F 34052	860275502100 814110760000 831900198400 814111675000	CER.TRAP 21 TPS 5,5MHZ SPULE 7X7 #600 FARBE342 OPFWIL G1985M FILTER 7X7 #750 SIGN11675
IC 34015 IC 40550 IC 50010 IC 60510 IC 61040 IC 61050 IC 61060 IC 80500 IC 81500 IC 81500 IC 84501	830512524600 830534726600 830533177100 830533464600 830520431700 830520431700 830520570300 830521006500 293052192500 830415506100 830536753000	IC STV2246 IC TDA7266B IC TDA1771 IC TDA16846 IC LM317T IC LM317T IC MC7805CT IC MC33164P-5RP PROZESSORPLATTE IC ST92195C9B1-S221 IC TFMS5300 STEHEND/TSOP	L 31043 L 32023 L 32026 L 32109 L 40512 L 52251 L 52256 L 53003	814052644000 814052653000 814052653000 814052690600 814050525900 814051174900 814052632000 810498205600	DR ST 0411-GRP 8,2UH 10% DR 0411 33UH 10% DR 0411 33UH 10% DR 0309 4,7UH 10% DR A AX-GA 27UH 10% DR AX 0411-GA 10UH 10% DR AX 0411-GA 3,3UH 10% FERRITPERLE HF70 BTL 3,5X FERRITE BEAD DR A AX-GA 10UH 10% LINEARITAETSREGLER LINEARITY CONTROL ZB-SPULE/ZB COIL FERRITPERLE 3,6UH 5720500 FERRITPERLE BL0R2N2-R62 FERRITE BEAD FUNKENTSTOERDROSSEL INTERFERENCE COIL FERRITPERLE HF55 BTL 3,5X FERRITE BEAD DR 0411 10UH 5% DR 0411 10UH 5%
L 53011 L 53021 L 53074 L 60506 L 61038 L 62501 L 81061 L 81062 L 81064 Q 34043	814050524900 292031149500 092468700101 810498205700 810498200300 295008269700 810498205100 814052636100 814052636100 838212104400	DR A AX-GA 10UH 10% LINEARITAETSREGLER LINEARITY CONTROL ZB-SPULE/ZB COIL FERRITPERLE 3,6UH 5720500 FERRITPERLE BL0R2N2-R62 FERRITE BEAD FUNKENTSTOERDROSSEL INTERFERENCE COIL FERRITPERLE HF55 BTL 3,5X FERRITE BEAD DR 0411 10UH 5% DR 0411 10UH 5%	Q 80001	838212104400	QUARZ 4,433619 MHZ
R 40551 R 43006 R 50050 R 53002 R 53009 R 53016 R 53021 R 53033 R 53033 R 54001 R 54006 R 60502 R 60504 R 60516 R 62501 R 62502 R 62549	873229240700 870001124600 870522705300 8700442909700 871033814500 873018942500 870522707100 870552101300 870552100500 870552102500 870552100900 870006935600 870006934700 879005004600 831120001600 831100501700 876504916100	DRW 4 1,8 OHM 10% KSW 0204 75 OHM 5% MOW 0411 150 OHM 5% KSW NB 0207 10 KOHM 5% MGW AX 1 MOHM 5% VR 37 DRW 9 10 OHM 10% 214-3 MOW 0411 820 OHM 5% MOW 0411 3,3 OHM 5% MOW 0411 1,5 OHM 5% MOW 0411 10 OHM 5% MOW 0411 2,2 OHM 5% KSW 0617 3 MOHM 2% KSW 0617 1,2 MOHM 2% ESTR.SK10-A 4,7 KOHM LIN PTC DUO T251-A80-A10 NTC 4,7 OHM 30% MSW SI 0414 4,7 MOHM VDE	SI 40551 SI 62501	831561902800 831561700600	SI LOET T1,6A 250V SI 5X20 T2,5A L 250V
T 52001 T 53001 T 60506	830328563700 830290002000 830280504000	TRANS BC637 TRANS S2055N TRANS IRFBC40	TR 52001 TR 53010 TR 53020 TR 61000	092468680400 292210315700 292016651101 292015219700	TRAFO TREIBER TRANSFORMER DRIVER TRAFO DIODEN-SPLIT 1,5 OHM TRANSFORMER DIODE SPLIT DIODEN-SPLIT TRAFO 3,3 OHM TRANSFORMER DIODE SPLIT SPERRWANDLERTRAFO B.O.TYPE CONVERTERV TRANSFORMER

Es gelten die Vorschriften und Sicherheitshinweise gemäß dem Service Manual "Sicherheit", Mat.-Nummer 720108000000, sowie zusätzlich die eventuell abweichenden, landesspezifischen Vorschriften!



The regulations and safety instructions shall be valid as provided by the "Safety" Service Manual, part number 720108000000, as well as the respective national deviations.

ÄNDERUNGEN VORBEHALTEN / SUBJECT TO ALTERATION

Ersatzteilliste
Spare Parts List

11 / 2000

CHASSIS-FS-STEREO CUC 2121 MULTI/DOLBY
CHASSIS TV STEREO CUC 2121 MULTI/DOLBY

MATERIAL-NR. / PART NO.: 297040130900

POS. NR. POS. NO.	ABB. FIG.	MATERIAL-NR. PART NUMBER	ANZ. QTY.	BEZEICHNUNG (D)	DESCRIPTION (GB)
		297040130900		CHASSIS-FS-STEREO CUC 2121 MUL/DOLBY KEIN E-TEIL	CHASSIS TV STEREO CUC 2121 MUL/DOLBY NO SPARE PART
0100.000		295043010100		TUNER-GLOBAL (PLL)	TUNER-GLOBAL (PLL)
0240.000		293033904200		KOPFHÖRERBUCHSE 3,5 O. SCHALTER	HEADPHONE SOCKET 3,5 W/O SWITCH
0241.000		293031680503		CINCH-BUCHSE 3-FACH FBAS/NF L,R	CINCH SOCKET 3 FOLD FBAS/NF L,R
0247.000		293031190602		EURO-AV BUCHSENLEISTE 21-POL SW	EURO-AV SOCKET STRIP 21 P BLACK
0300.000		293052192600		PROZESSORPLATTE	PROCESSOR BOARD
0312.000		297006430104		ABDECKUNG EURO-AV	COVER EURO AV
0451.000		295002410901		BAUSTEINSICHERUNG	MODULE LOCKING DEVICE
0500.000		295041028400	X	BAUSTEIN STEREO	STEREO MODULE
0910.000	△	292107030101		FOKUSLEITUNG	FOCUSING CABLE
1000.000	△	096211130206	2	SICHERUNGSHALTER Si62501	FUSE HOLDER Si62501
1310.000		297033571100		TASTSCHALTER PROGRAMM +	KEY SWITCH PROGRAMME +
1320.000		297033571100		TASTSCHALTER PROGRAMM -	KEY SWITCH PROGRAMME -
1330.000		297033571100		TASTSCHALTER LAUTSTÄRKE +	KEY SWITCH VOLUME +
1340.000		297033571100		TASTSCHALTER LAUTSTÄRKE -	KEY SWITCH VOLUME -
2000.000	△	297033910600		NETZSCHALTER O.WISCHER	POWER SWITCH W/O WIPER
2200.000	△	293033995100		NETZ EINBAUGERÄTESTECKER	APPLIANCE COUPLER
2410.000		293031530208	2	MONTAGECLIP IC40550/T53001	MOUNTING CLIP IC40550/T53001
2420.000		293031530304		MONTAGECLIP IC50010	MOUNTING CLIP IC50010
2430.000		293031531600		MONTAGECLIP T60020	MOUNTING CLIP T60020
2440.000		293031531605	3	MONTAGECLIP IC61040/61050/61060	MOUNTING CLIP IC61040/61050/61060
2470.000		293031562000	4	FOLIE WÄRMELEITEND T60020 IC61040/61050/61060	FOIL HEAT CONDUCTING T60020 IC61040/61050/61060

X = SIEHE GESONDERT E-LISTE

X = SEE SEPARATE PARTS LIST

POS. NR. POS. NO.	MATERIAL-NR. PART NUMBER	BEZEICHNUNG DESCRIPTION	POS. NR. POS. NO.	MATERIAL-NR. PART NUMBER	BEZEICHNUNG DESCRIPTION
C 34026	845296706400	ELKO 1000UF +50-20% 10V	C 81063	814054010400	EMIFIL 0,1 UF
C 40557	845299610700	ELKO 2200UF 20% 16V	CD 32411	830940159200	SMD DIODE BA591/BA592
C 50047	845299618700	ELKO 1000UF 20% 35V	CD 32460	830940159200	SMD DIODE BA591/BA592
C 50048	845299664700	ELKO 1000UF 20% 25V	CD 32470	830940159200	SMD DIODE BA591/BA592
C 53002	851591111400	FOKO KF #35 9000PF 3,5% 1500V	CD 80501	830940159200	SMD DIODE BA591/BA592
C 54011	865006704600	KERKO HV C 100PF 20% 1KV	CIC80910	830581409400	SMD IC MC14094BD
C 54012	845299618700	ELKO 1000UF 20% 35V	CIC80930	830595012900	SMD IC ST92R195C9Q1
C 60501	865008112500	KERKO HV C 1000PF 20% 1KV	CIC82501	830596000800	SMD IC M24C08CM1TR
C 60512	865008111100	KERKO HV C 270PF 20% 2KV	CT 32111	830100484800	SMD TRANS BC848B/ BC847B
C 60523	865008112500	KERKO HV C 1000PF 20% 1KV	CT 32122	830100385800	SMD TRANS BC858B/ BC857B
C 60524	865008112500	KERKO HV C 1000PF 20% 1KV	CT 32123	830100484800	SMD TRANS BC848B/ BC847B
C 60526	865008112500	KERKO HV C 1000PF 20% 1KV	CT 32124	830100385800	SMD TRANS BC858B/ BC857B
C 60527	865008112500	KERKO HV C 1000PF 20% 1KV	CT 32132	830100484800	SMD TRANS BC848B/ BC847B
C 60528	845209711500	KERKO SNT #40 150UF 385V/400V	CT 32460	830100484800	SMD TRANS BC848B/ BC847B
C 60529	845199711500	ELKO 19 150UF 385V	CT 32470	830100484800	SMD TRANS BC848B/ BC847B
C 61017	845209713100	KERKO #31 100UF 250V	CT 32480	830100484800	SMD TRANS BC848B/ BC847B
C 61036	865006704600	KERKO HV C 100PF 20% 1KV	CT 34031	830100385800	SMD TRANS BC858B/ BC857B
C 61056	865006704600	KERKO HV C 100PF 20% 1KV	CT 40581	830100385800	SMD TRANS BC858B/ BC857B
C 62501	851179301800	MP3 0,1UF 20% 250V	CT 43010	830100385800	SMD TRANS BC858B/ BC857B
C 62521	866009623800	KERKO SI 2200PF 20%			
C 62522	866009623800	KERKO SI 2200PF 20%			
C 62548	866009623400	KERKO SI 1000PF 20%			

ÄNDERUNGEN VORBEHALTEN / SUBJECT TO ALTERATION

GRUNDIG

TV

POS. NR. MATERIAL-NR. BEZEICHNUNG
POS. NO. PART NUMBER DESCRIPTION

CT 43015	830100484800	SMD TRANS BC848B/ BC847B
CT 50005	830100484800	SMD TRANS BC848B/ BC847B
CT 50015	830100484800	SMD TRANS BC848B/ BC847B
CT 50040	830100484800	SMD TRANS BC848B/ BC847B
CT 50050	830100484800	SMD TRANS BC848B/ BC847B
CT 50055	830100484800	SMD TRANS BC848B/ BC847B
CT 52260	830100385800	SMD TRANS BC858B/ BC857B
CT 57020	830100385800	SMD TRANS BC858B/ BC857B
CT 57021	830100385800	SMD TRANS BC858B/ BC857B
CT 57112	830100385800	SMD TRANS BC858B/ BC857B
CT 57113	830100385800	SMD TRANS BC858B/ BC857B
CT 57124	830100484800	SMD TRANS BC848B/ BC847B
CT 61043	830100484800	SMD TRANS BC848B/ BC847B
CT 61053	830100484800	SMD TRANS BC848B/ BC847B
CT 81220	830100484800	SMD TRANS BC848B/ BC847B
CT 81225	830100484800	SMD TRANS BC848B/ BC847B
CT 85502	830100385800	SMD TRANS BC858B/ BC857B
D 1806	830994460100	LE DIODE TLHR 4601
D 40584	830921504500	DIODE 1N4148
D 40586	830921504500	DIODE 1N4148
D 43055	830921504500	DIODE 1N4148
D 43056	830921504500	DIODE 1N4148
D 50023	830921502000	DIODE 1N 4004
D 50048	830970301400	Z-DIODE ZPY5,6 2%
D 52001	830921504500	DIODE 1N4148
D 53003	830920100500	DIODE BA157
D 54001	830920426800	DIODE BYV16/ BYV96E
D 54011	830920100500	DIODE BA157
D 54022	830970713500	Z DIODE 33 B 0,5W
D 57013	830921504500	DIODE 1N4148
D 57023	830921504500	DIODE 1N4148
D 60506	830951685400	DIODE BYT 54 M
D 60509	830966318000	Z-DIODE BZT03D180
D 60512	830951675400	DIODE BYT53B/ EGP10B
D 60523	830856038400	GLR.SK8380C1500/ FBI2L52-4
D 61016	830951717800	DIODE BYW178 TEMIC/ FUF5407
D 61036	830951710800	DIODE BYT108-400
D 61056	830951717200	DIODE BYW172D/ FUF5402
F 32109	860275506600	KERTRAP #66 5,5/6/6,5MHZ
F 32121	814111136000	FILTER 7X7 360 SIGN 11136
F 32410	814053445100	SPULE 7X7 #451 SIGN534451
F 32412	831900395300	OFWFL K395530
F 32430	831900465400	OFWFL K4654K
F 34052	814111675000	FILTER 7X7 #750 SIGN11675
IC 34015	830512524800	IC STV2248
IC 40550	830534726600	IC TDA7266B
IC 50010	830533177100	IC TDA1771
IC 60510	830533464600	IC TDA16846
IC 61040	830520431700	IC LM317T
IC 61050	830520431700	IC LM317T
IC 61060	830520570300	IC MC7805CT
IC 80500	830521006500	IC MC33164P-5RP/ TS831-5I
IC 80920	297980200100	IC 27C020-15NS PROG.KPL
IC 81500	830415507100	IC ST92195C9B1-S231
IC 84501	830536753000	IC TFM5300 STEHEND
L 31043	814052644000	DR ST 0411-GRP 8,2UH 10%
L 32109	814052696000	DR 0309 4,7UH 10%
L 40512	814050525900	DR A AX-GA 27UH 10%
L 52251	814051174900	DR AX 0411-GA 10UH 10%
L 52256	814052632000	DR AX 0411-GA 3,3UH 10%
L 53003	810498205600	FERRITPERLE HF70 BTL 3,5X FERRITE BEAD

Es gelten die Vorschriften und Sicherheitshinweise gemäß dem Service Manual "Sicherheit", Mat.-Nummer 720108000000, sowie zusätzlich die eventuell abweichenden, landesspezifischen Vorschriften!



The regulations and safety instructions shall be valid as provided by the "Safety" Service Manual, part number 720108000000, as well as the respective national deviations.

ÄNDERUNGEN VORBEHALTEN / SUBJECT TO ALTERATION

Ersatzteilliste
Spare Parts List

12 / 2000

CHASSIS-FS-STEREO CUC 2121/INL/DOLBY
CHASSIS TV STEREO CUC 2121/INL/DOLBY

MATERIAL-NR. / PART NO.: 297040131000

POS. NR. POS. NO.	ABB. FIG.	MATERIAL-NR. PART NUMBER	ANZ. QTY.	BEZEICHNUNG (D)	DESCRIPTION (GB)
		297040131000		CHASSIS-FS-STEREO CUC 2121/INL/DOLBY KEIN E-TEIL	CHASSIS TV STEREO CUC 2121/INL/DOLBY NO SPARE PART
0100.000		295043010100		TUNER-GLOBAL (PLL)	TUNER-GLOBAL (PLL)
0216.000		297033571100		TASTSCHALTER PROGRAMM +	KEY SWITCH PROGRAMME +
0216.000		297033571100		TASTSCHALTER PROGRAMM -	KEY SWITCH PROGRAMME -
0216.000		297033571100		TASTSCHALTER LAUTSTÄRKE +	KEY SWITCH VOLUME +
0216.000		297033571100		TASTSCHALTER LAUTSTÄRKE -	KEY SWITCH VOLUME -
0240.000		293033904200		KOPFHOERERBUCHSE 3,5mm O.SCHALTER	HEADPHONE SOCKET 3,5mm W/O SWITCH
0241.000		293031680503		CINCH-BUCHSE 3-FACH FBAS/NF L,R	CINCH SOCKET 3 FOLD FBAS/AF L,R
0247.000		293031190602		EURO-AV BUCHSENLEISTE 21-POL SW	EURO-AV SOCKET STRIP 21 PIN BLACK
0312.000		297006430104		ABDECKUNG EURO-AV	COVER EURO AV
0500.000		295041028400	X	BAUSTEIN STEREO	STEREO MODULE
0910.000	△	292107030101		FOKUSLEITUNG	FOCUSING CABLE
1000.000	△	096211130206	2	SICHERUNGSHALTER SI62501	FUSE HOLDER SI62501
2000.000	△	297033910600		NETZSCHALTER O.WISCHER	POWER SWITCH W/O WIPER
2200.000	△	293033995100		NETZ EINBAUGERÄTESTECKER	APPLIANCE COUPLER
2410.000		293031530208	2	MONTAGECLIP IC40550/T53001	MOUNTING CLIP IC40550/T53001
2420.000		293031530304		MONTAGECLIP IC50010	MOUNTING CLIP IC50010
2440.000		293031531600		MONTAGECLIP T60506	MOUNTING CLIP T60506
2445.000		293031531605	3	MONTAGECLIP IC61040/61050/61060	MOUNTING CLIP IC61040/61050/61060
2470.000		293031562000	4	FOLIE WAERMELEITEND IC61040/ 61050/61060/T60506	FOIL HEAT CONDUCTING IC61040/ 61050/61060/T60506

X = SIEHE GESONDERTE E-LISTE
WW. = WAHLWEISEX = SEE SEPARATE PARTS LIST
WW. = OPTIONAL

POS. NR. POS. NO.	MATERIAL-NR. PART NUMBER	BEZEICHNUNG DESCRIPTION	POS. NR. POS. NO.	MATERIAL-NR. PART NUMBER	BEZEICHNUNG DESCRIPTION
C 34026	845296706400	ELKO 1000UF +50-20% 10V	CD 80501	830940159200	SMD DIODE BA591
C 40557	845299610700	ELKO 2200UF 20% 16V			
C 50047	845299618700	ELKO 1000UF 20% 35V	CIC82501	830596000800	SMD IC M24C08CM1TR
C 50048	845299864700	ELKO 1000UF 20% 25V			
C 53002	851591111400	FOKO KF #35 9000PF 3,5% 1500V	CT 32124	830100385800	SMD TRANS BC858B/BC857B
C 54011	865006704600	KERKO HV C 100PF 20% 1KV	CT 34031	830100385800	SMD TRANS BC858B/BC857B
C 54012	845299618700	ELKO 1000UF 20% 35V	CT 40581	830100385800	SMD TRANS BC858B/BC857B
C 60501	865008112500	KERKO HV C 1000PF 20% 1KV	CT 43010	830100385800	SMD TRANS BC858B/BC857B
C 60509	851591104500	FOKO FKP1 680PF 10% 1600V	CT 43015	830100484800	SMD TRANS BC848B/BC847B
C 60512	865008111100	KERKO HV C 270PF 20% 2KV	CT 50005	830100484800	SMD TRANS BC848B/BC847B
C 60523	865008112500	KERKO HV C 1000PF 20% 1KV	CT 50015	830100484800	SMD TRANS BC848B/BC847B
C 60524	865008112500	KERKO HV C 1000PF 20% 1KV	CT 50040	830100484800	SMD TRANS BC848B/BC847B
C 60526	865008112500	KERKO HV C 1000PF 20% 1KV	CT 50050	830100484800	SMD TRANS BC848B/BC847B
C 60527	865008112500	KERKO HV C 1000PF 20% 1KV	CT 50055	830100484800	SMD TRANS BC848B/BC847B
C 61016	851591104000	FOKO FKP1 220PF 10% 1600V	CT 52260	830100385800	SMD TRANS BC858B/BC857B
C 61036	865006704600	KERKO HV C 100PF 20% 1KV	CT 57020	830100385800	SMD TRANS BC858B/BC857B
C 61056	865006704600	KERKO HV C 100PF 20% 1KV	CT 57021	830100385800	SMD TRANS BC858B/BC857B
C 62501	851179301800	MP3 0,1UF 20% 250V	CT 57112	830100385800	SMD TRANS BC858B/BC857B
C 62521	866009623800	KERKO SI 2200PF 20% 400V	CT 57113	830100385800	SMD TRANS BC858B/BC857B
C 62522	866009623800	KERKO SI 2200PF 20% 400V	CT 57124	830100484800	SMD TRANS BC848B/BC847B
C 62548	866009623400	KERKO SI 1000PF 20% 400V	CT 61043	830100484800	SMD TRANS BC848B/BC847B
C 81063	814054010400	EMIFIL 0,1 UF -GR	CT 61053	830100484800	SMD TRANS BC848B/BC847B
			CT 81220	830100484800	SMD TRANS BC848B/BC847B

ÄNDERUNGEN VORBEHALTEN / SUBJECT TO ALTERATION

POS. NR. POS. NO.	MATERIAL-NR. PART NUMBER	BEZEICHNUNG DESCRIPTION	POS. NR. POS. NO.	MATERIAL-NR. PART NUMBER	BEZEICHNUNG DESCRIPTION
CT 81225	830100484800	SMD TRANS BC848B/BC847B	F 32109	860275502100	CER.TRAP 21 TPS 5,5MHZ
CT 85502	830100385800	SMD TRANS BC858B/BC857B	F 32410	814110760000	SPULE 7X7 #600 FARBE342
D 40584	830921504500	DIODE 1N4148	F 32412	831900198400	OPFWIL G1985M
D 40586	830921504500	DIODE 1N4148	F 34052	814111675000	FILTER 7X7 #750 SIGN11675
D 43055	830921504500	DIODE 1N4148	IC 34015	830512524600	IC STV2246
D 43056	830921504500	DIODE 1N4148	IC 40550	830534726600	IC TDA7266B
D 50023	830921502000	DIODE 1N4004	IC 50010	830533177100	IC TDA1771
D 50048	830970301400	Z-DIODE ZPY5,6 2%	IC 60510	830533464600	IC TDA16846
D 52001	830921504500	DIODE 1N4148	IC 61040	830520431700	IC LM317T
D 53003	830920100500	DIODE BA157	IC 61050	830520431700	IC LM317T
D 54001	830920426800	DIODE BYV16	IC 61060	830520570300	IC MC7805CT
D 54011	830920100500	DIODE BA157	IC 80500	830521006500	IC MC33164P-5RP
D 54022	830970713500	Z DIODE 33B 0,5W	IC 81500	830415506100	IC ST92195C9B1-S221
D 57013	830921504500	DIODE 1N4148	WW.	293052192500	PROZESSORPLATTE CUC2121
D 57023	830921504500	DIODE 1N4148	IC 84501	830536753000	IC TFMS5300 STEHEND/T SOP
D 60506	830951685400	DIODE BYT 54M	L 31043	814052644000	DR ST 0411-GRP 8,2UH 10%
D 60509	830966318000	Z-DIODE BZT03D180	L 32023	814052653000	DR 0411 33UH 10%
D 60512	830951675400	DIODE BYT53B	L 32026	814052653000	DR 0411 33UH 10%
D 60523	830856038400	GLR.SKB380C1500	L 32109	814052690600	DR 0309 4,7UH 10%
D 61016	△ 830951717800	DIODE BYW178	L 40512	814050525900	DR A AX-GA 27UH 10%
D 61036	△ 830951710800	DIODE BYT 108-400	L 52251	814051174900	DR AX 0411-GA 10UH 10%
D 61056	△ 830951717200	DIODE BYW172D	L 52256	814052632000	DR AX 0411-GA 3,3UH 10%
D 85001	830994460100	LE DIODE TLHR4601	L 53003	810498205600	FERRITPERLE HF70 BTL 3,5X FERRITE BEAD
F 32109	860275502100	CER.TRAP 21 TPS 5,5MHZ	L 53011	814050524900	DR A AX-GA 10UH 10%
F 32410	814110760000	SPULE 7X7 #600 FARBE342	L 53021	292031149500	LINEARITAETSREGLER LINEARITY CONTROL
F 32412	831900198400	OPFWIL G1985M	L 53074	092468700101	ZB-SPULE/ZB COIL
F 34052	814111675000	FILTER 7X7 #750 SIGN11675	L 60506	810498205700	FERRITPERLE 3,6UH 5720500
IC 34015	830512524600	IC STV2246	L 61038	810498200300	FERRITPERLE BL02RN2-R62 FERRITE BEAD
IC 40550	830534726600	IC TDA7266B	L 62501	△ 295008269700	FUNKENTSTOERDROSSEL INTERFERENCE CHOKE
IC 50010	830533177100	IC TDA1771	L 81061	810498205100	FERRITPERLE HF55 BTL 3,5X FERRITE BEAD
IC 60510	830533464600	IC TDA16846	L 81062	814052636100	DR 0411 10UH 5%
IC 61040	830520431700	IC LM317T	L 81064	814052636100	DR 0411 10UH 5%
IC 61050	830520431700	IC LM317T	Q 34043	838212104400	QUARZ 4,433619 MHZ
IC 61060	830520570300	IC MC7805CT			
IC 80500	830521006500	IC MC33164P-5RP			
IC 81500	830415506100	IC ST92195C9B1-S221			
WW.	293052192500	PROZESSORPLATTE CUC2121			
IC 84501	830536753000	IC TFMS5300 STEHEND/T SOP			

Es gelten die Vorschriften und Sicherheitshinweise gemäß dem Service Manual "Sicherheit", Mat.-Nummer 720108000000, sowie zusätzlich die eventuell abweichenden, landesspezifischen Vorschriften!



The regulations and safety instructions shall be valid as provided by the "Safety" Service Manual, part number 720108000000, as well as the respective national deviations.

ÄNDERUNGEN VORBEHALTEN / SUBJECT TO ALTERATION

Ersatzteilliste
Spare Parts List

3 / 2001

CHASSIS-FS-STEREO CUC 2121 INL/DOLBY
CHASSIS TV STEREO CUC 2121 INL/DOLBY

MATERIAL-NR. / PART NO.: 297040132100

POS. NR. POS. NO.	ABB. FIG.	MATERIAL-NR. PART NUMBER	ANZ. QTY.	BEZEICHNUNG (D)	DESCRIPTION (GB)
		297040132100		CHASSIS-FS-STEREO CUC 2121 INL/DOLBY KEIN E-TEIL	CHASSIS TV STEREO CUC 2121 INL/DOLBY NO SPARE PART
0100.000		295043010100		TUNER-GLOBAL (PLL)	TUNER-GLOBAL (PLL)
0206.000		297006430104		ABDECKUNG EURO-AV	COVER EURO AV
0216.000		297033571100		TASTSCHALTER PROGRAMM +	KEY SWITCH PROGRAMME +
0216.000		297033571100		TASTSCHALTER PROGRAMM -	KEY SWITCH PROGRAMME -
0216.000		297033571100		TASTSCHALTER LAUTSTAERKE +	KEY SWITCH VOLUME +
0216.000		297033571100		TASTSCHALTER LAUTSTAERKE -	KEY SWITCH VOLUME -
0241.000		293031680503		CINCH-BUCHSE 3-FACH FBAS/NF L,R	CINCH SOCKET 3 FOLD FBAS/AF L,R
0242.000		293033904200		KOPFHÖRERBUCHSE 3,5mm O.SCHALTER	HEADPHONE SOCKET 3,5mm W/O SWITCH
0247.000		293031190602		EURO-AV BUCHSENLEISTE 21-POL SW	EURO-AV SOCKET STRIP 21 PIN BLACK
0400.000		295041028300	X	BAUSTEIN STEREO MODUL	MODULE STEREO
0910.000	△	292107030101		FOKUSLEITUNG	FOCUSING CABLE
1000.000	△	096211130206	2	SICHERUNGSHALTER SI62501	FUSE HOLDER SI62501
2000.000	△	297033910600		NETZSCHALTER O.WISCHER	POWER SWITCH W/O WIPER
2200.000	△	293033995100		NETZ EINBAUGERÄTESTECKER	APPLIANCE COUPLER
2410.000		293031530208	2	MONTAGECLIP IC40550/T53001	MOUNTING CLIP IC40550/T53001
2420.000		293031530304		MONTAGECLIP IC50010	MOUNTING CLIP IC50010
2440.000		293031531600		MONTAGECLIP T60506	MOUNTING CLIP T60506
2445.000		293031531605	3	MONTAGECLIP IC61040/61050/61060	MOUNTING CLIP IC61040/61050/61060
2470.000		293031562000	4	FOLIE WAERMELEITEND IC61040/ 61050/61060/T60506	FOIL HEAT CONDUCTING IC61040/ 61050/61060/T60506
				X = SIEHE GESONDERTE E-LISTE WW. = WAHLWEISE	X = SEE SEPARATE PARTS LIST WW. = OPTIONAL

POS. NR. POS. NO.	MATERIAL-NR. PART NUMBER	BEZEICHNUNG DESCRIPTION	POS. NR. POS. NO.	MATERIAL-NR. PART NUMBER	BEZEICHNUNG DESCRIPTION
C 34026	845296706400	ELKO 1000UF +50-20% 10V	CD 80501	830940159200	SMD DIODE BA591
C 40557	845299610700	ELKO 2200UF 20% 16V	CIC80910	830581409400	SMD IC MC14094BD
C 50047	845299618700	ELKO 1000UF 20% 35V	CIC80930	830595012900	SMD IC ST92R195C9Q1
C 50048	845299664700	ELKO 1000UF 20% 25V	CIC82501	830596008000	SMD IC M24C08CM1TR
C 53002	851591110200	FOKO FKP1/4 8500PF 1500V	CL 40511	810498233100	SMD DAEMPF-LEISTE 0805 BLM SMD DAMPING BEAD
C 54011	865006704600	KERKO HV C 100PF 20% 1KV	CT 32124	830100385800	SMD TRANS BC858B/BC857B
C 54012	865006704600	KERKO HV C 100PF 20% 2KV	CT 34031	830100385800	SMD TRANS BC858B/BC857B
C 54023	845299618700	ELKO 1000UF 20% 35V	CT 40581	830100385800	SMD TRANS BC858B/BC857B
C 60501	865008112500	KERKO HV C 1000PF 20% 1KV	CT 43010	830100385800	SMD TRANS BC858B/BC857B
C 60509	851591104500	FOKO FKP1 680PF 10% 1600V	CT 43015	830100484800	SMD TRANS BC848B/BC847B
C 60512	865008111100	KERKO HV C 270PF 20% 2KV	CT 50005	830100484800	SMD TRANS BC848B/BC847B
C 60523	865008112500	KERKO HV C 1000PF 20% 1KV	CT 50015	830100484800	SMD TRANS BC848B/BC847B
C 60524	865008112500	KERKO HV C 1000PF 20% 1KV	CT 50040	830100484800	SMD TRANS BC848B/BC847B
C 60526	865008112500	KERKO HV C 1000PF 20% 1KV	CT 50050	830100484800	SMD TRANS BC848B/BC847B
C 60527	865008112500	KERKO HV C 1000PF 20% 1KV	CT 50055	830100484800	SMD TRANS BC848B/BC847B
C 61016	851591104000	FOKO FKP1 220PF 10% 1600V	CT 52260	830100385800	SMD TRANS BC858B/BC857B
C 61036	865006704600	KERKO HV C 100PF 20% 1KV	CT 57020	830100385800	SMD TRANS BC858B/BC857B
C 61056	865006704600	KERKO HV C 100PF 20% 1KV	CT 57021	830100385800	SMD TRANS BC858B/BC857B
C 62501	△ 851179301800	MP3 0,1UF 20% 250V			
C 62521	△ 866009623800	KERKO SI 2200PF 20% 400V			
C 62522	△ 866009623800	KERKO SI 2200PF 20% 400V			
C 62548	△ 866009623400	KERKO SI 1000PF 20% 400V			
C 81063	814054010400	EMIFIL 0,1 UF -GR			

ÄNDERUNGEN VORBEHALTEN / SUBJECT TO ALTERATION

GRUNDIG

TV

POS. NR. POS. NO.	MATERIAL-NR. PART NUMBER	BEZEICHNUNG DESCRIPTION	POS. NR. POS. NO.	MATERIAL-NR. PART NUMBER	BEZEICHNUNG DESCRIPTION
CT 57112	830100385800	SMD TRANS BC858B/BC857B	L 61038	810498200300	FERRITPERLE BL02RN2-R62
CT 57113	830100385800	SMD TRANS BC858B/BC857B	L 62501	△ 295008269700	FERRITE BEAD FUNKTENTSTOERDRÖSSEL INTERFERENCE COIL
CT 57124	830100484800	SMD TRANS BC848B/BC847B	L 81061	810498205100	FERRITPERLE HF55 BTL 3,5X FERRITE BEAD
CT 61043	830100484800	SMD TRANS BC848B/BC847B	L 81062	814052636100	DR 0411 10UH 5%
CT 61053	830100484800	SMD TRANS BC848B/BC847B	L 81064	814052636100	DR 0411 10UH 5%
CT 81220	830100484800	SMD TRANS BC848B/BC847B	Q 34043	838212104400	QUARZ 4,433619 MHZ
CT 81225	830100484800	SMD TRANS BC848B/BC847B	Q 80001	838208004000	QUARZ 4 MHZ
CT 85502	830100385800	SMD TRANS BC858B/BC857B	Q 80951	838216204100	QUARZ 4 MHZ
D 40584	830921504500	DIODE 1N4148	R 40551	873229240700	DRW 4 1,8 OHM 10%
D 40586	830921504500	DIODE 1N4148	R 43006	870001124600	KSW 0204 75 OHM 5%
D 43055	830921504500	DIODE 1N4148	R 50048	△ 870552103300	MOW 0411 22 OHM 5%
D 43056	830921504500	DIODE 1N4148	R 50050	△ 870522705300	MOW 0411 150 OHM 5%
D 50023	830921504500	DIODE 1N4148	R 52004	△ 870552105300	MOW 0411 150 OHM 5%
D 50048	830970301400	Z-DIODE ZPV5,6 2%	R 53002	△ 870042909700	KSW NB 0207 10 KOHM 5%
D 52001	830921504500	DIODE 1N4148	R 53009	871033814500	MGW AX 1 MOHM 5%
D 53003	830920100500	DIODE BA157	R 53011	△ 870552102100	MOW 0411 6,8 OHM 5%
D 54001	830920426800	DIODE BYV16	R 53016	873018942500	DRW 9 10 OHM 10%
D 54011	830920100500	DIODE BA157	R 53021	△ 870522707100	MOW 0411 820 OHM 5%
D 54022	830972033000	Z-DIODE 30 B 0,5W	R 53033	△ 870552098500	MOW 0411 0,22 OHM 5%
D 57013	830921504500	DIODE 1N4148	R 53033	△ 870552100300	MOW 0411 1,2 OHM 5%
D 57023	830921504500	DIODE 1N4148	R 54001	△ 870552102500	MOW 0411 10 OHM 5%
D 60506	△ 830951685400	DIODE BYT54M	R 54006	△ 870552100900	MOW 0411 2,2 OHM 5%
D 60509	△ 830966318000	Z-DIODE BZT03D180	R 54022	△ 870556111100	MOW 0617 39 KOHM 5%
D 60512	830951675400	DIODE BYT53B	R 60502	870006935600	KSW 0617 3 MOHM 2%
D 60523	830856038400	GLR.SKB380C1500	R 60504	870006934700	KSW 0617 1,2 MOHM 2%
D 61016	△ 830951717800	DIODE BYW178	R 60508	△ 870556110500	MOW 0617 22 KOHM 5%
D 61037	△ 830951710800	DIODE BYW178-400	R 60509	△ 870556110500	MOW 0617 22 KOHM 5%
D 61056	△ 830951712200	DIODE BYW1102	R 60516	879005004600	ESTR.SK10-A 4,7 KOHM LIN
D 85001	830994460100	LE DIODE TLHR4601	R 62501	△ 831120001800	PTC DUO B59709-T60-A110
F 32109	860275502100	CER.TRAP 21 TPS 5,5MHZ	R 62502	831100501700	NTC 4,7 OHM 30%
F 32410	814110760100	SPLFUE 7X7 #601 SIGN107601	R 62549	△ 876504916100	MSW SI 0414 4,7 MOHM VDE
F 32412	8311900198400	OPWFL G1985M	SI 40551	△ 831561902800	SI LOET T1,6A 250V
F 34052	814111675000	FILTER 7X7 #750 SIGN11675	SI 62501	△ 831561700600	SI 5X20 T2,5A L 250V
IC 34015	830512524600	IC STV2246	T 50506	830280504000	TRANS IRFBC40
IC 40550	830534726600	IC TDA7266B	T 52001	830328563700	TRANS BC637
IC 50010	830533177100	IC TDA1771	T 53001	830290002200	TRANS S2055N
IC 60510	830533464600	IC TDA16846	TR 52001	092468680400	TRAF0 TREIBER TRANSFORMER DRIVER
IC 61040	830520431700	IC LM317T	TR 53010	△ 292210315700	TRAF0 DIODEN-SPLIT BEI R 53033 = 0,22 OHM TRANSFORMER DIODE SPLIT FOR R 53033 = 0,22 OHM
IC 61050	830520431700	IC LM317T	TR 53020	△ 292016651101	TRAF0 DIODEN-SPLIT BEI R 53033 = 1,2 OHM TRANSFORMER DIODE SPLIT FOR R 53033 = 1,2 OHM
IC 61060	830520570300	IC MC7805CT	TR 61000	△ 292015219700	SPERRWANDLERTRAF0 B.O.TYPE CONVERTER TRANSFORMER
IC 80500	830521006500	IC MC33164P-SRP			
IC 80920	297980190300	IC 27C020 PROG.KPL			
IC 81500	830415506200	IC ST92195C9B1-S222			
IC 81500	293052192700	PROZESSORPLATTE			
WW.	293052192500	PROZESSORPLATTE			
WW.	830415506100	IC ST92195C9B1-S221			
IC 84501	830536753000	IC TFM53300 STEHEND/TSOP			
L 31043	814052644000	DR ST 0411-GRP 8,2UH 10%			
L 32023	814052653000	DR 0411 33UH 10%			
L 32026	814052653000	DR 0411 33UH 10%			
L 32109	814052690600	DR 0309 4,7UH 10%			
L 40512	814050525900	DR A AX-GA 27UH 10%			
L 52251	814051174900	DR AX 0411-GA 10UH 10%			
L 52256	814052632000	DR AX 0411-GA 3,3UH 10% CHOKE			
L 53003	810498205600	FERRITPERLE HF70 BTL 3,5X FERRITE BEAD			
L 53011	814050524900	DR A AX-GA 10UH 10%/CHOKE			
L 53021	292031149500	LINEARITÄTREGLER LINEARITY CONTROL			
L 53074	092468700101	ZB-SPULE/ZB COIL			
L 60506	810498205700	FERRITPERLE 3,6UH 5720500			

Es gelten die Vorschriften und Sicherheitshinweise gemäß dem Service Manual "Sicherheit", Mat.-Nummer 720108000000, sowie zusätzlich die eventuell abweichenden, landesspezifischen Vorschriften!



The regulations and safety instructions shall be valid as provided by the "Safety" Service Manual, part number 720108000000, as well as the respective national deviations.

ÄNDERUNGEN VORBEHALTEN / SUBJECT TO ALTERATION



Ersatzteilliste Spare Parts List

5 / 2001

CHASSIS-FS-STEREO CUC 2121 GB/DOLBY CHASSIS TV STEREO CUC 2121 GB/DOLBY

MATERIAL-NR. / PART NO.: 297040133100

POS. NR. POS. NO.	ABB. FIG.	MATERIAL-NR. PART NUMBER	ANZ. QTY.	BEZEICHNUNG (D)	DESCRIPTION (GB)
		297040133100		CHASSIS-FS-STEREO CUC 2121 GB/DOLBY KEIN E-TEIL	CHASSIS TV STEREO CUC 2121 GB/DOLBY NO SPARE PART
0100.000	△	295043010100		TUNER-GLOBAL (PLL)	TUNER-GLOBAL (PLL)
0206.000		297006430104		ABDECKUNG EURO-AV	COVER EURO AV
0216.000		297033571100		TASTSCHALTER PROGRAMM +	KEY SWITCH PROGRAMME +
0216.000		297033571100		TASTSCHALTER PROGRAMM -	KEY SWITCH PROGRAMME -
0216.000		297033571100		TASTSCHALTER LAUTSTAERKE +	KEY SWITCH VOLUME +
0216.000		297033571100		TASTSCHALTER LAUTSTAERKE -	KEY SWITCH VOLUME -
0240.000		293033904200		KOPFHÖRERBUCHSE 3,5mm O.SCHALTER	HEADPHONE SOCKET 3,5mm W/O SWITCH
0241.000		293031680503		CINCH-BUCHSE 3-FACH FBAS/NF L,R	CINCH SOCKET 3 FOLD FBAS/AF L,R
0247.000		293031190603		EURO-AV BUCHSENLEISTE 21-POL SW	EURO-AV SOCKET STRIP 21 PIN BLACK
0500.000		295041028400	X	BAUSTEIN STEREO	STEREO MODULE
0910.000	△	292107030101		FOKUSLEITUNG	FOCUSING CABLE
1000.000	△	096221130206	2	SICHERUNGSHALTER SI62501	FUSE HOLDER SI62501
2000.000	△	297033910600		NETZSCHALTER O.WISCHER	POWER SWITCH W/O WIPER
2200.000	△	293033995100		NETZ EINBAUGERÄTESTECKER	APPLIANCE COUPLER
2410.000		293031530208	2	MONTAGECLIP IC40550/T53001	MOUNTING CLIP IC40550/T53001
2420.000		293031530304		MONTAGECLIP IC50010	MOUNTING CLIP IC50010
2440.000		293031531360		MONTAGECLIP T60506	MOUNTING CLIP T60506
2445.000		293031531605	3	MONTAGECLIP IC61040/61050/61060	MOUNTING CLIP IC61040/61050/61060
2470.000		293031562000	4	FOLIE WAERMELEITEND IC61040/ 61050/61060/T60506	FOIL HEAT CONDUCTING IC61040/ 61050/61060/T60506
				X = SIEHE GESONDERTE E-LISTE WW. = WAHLWEISE	X = SEE SEPARATE PARTS LIST WW. = OPTIONAL

POS. NR. POS. NO.	MATERIAL-NR. PART NUMBER	BEZEICHNUNG DESCRIPTION	POS. NR. POS. NO.	MATERIAL-NR. PART NUMBER	BEZEICHNUNG DESCRIPTION
C 34026	845296706400	ELKO 1000UF +50-20% 10V	CIC80910	830581409400	SMD IC MC14094BD
C 40557	845299610700	ELKO 2200UF 20% 18V	CIC80930	830595012900	SMD IC ST92R195C9Q1
C 50047	845299618700	ELKO 1000UF 20% 35V	CIC82501	830596000800	SMD IC M24C08CM1TR
C 50048	845299864700	ELKO 1000UF 20% 25V			
C 53002	851591111400	FOKO KF #35 9000PF 3,5% 1500V	CL 40511	810498233100	SMD DAEMPF-PERLE 0805 BLM
C 54011	865006704600	KERKO HV C 100PF 20% 1KV			
C 54012	845299618700	ELKO 1000UF 20% 35V	CT 32124	830100385800	SMD TRANS BC858B/BC857B
C 60501	865008112500	KERKO HV C 1000PF 20% 1KV	CT 34031	830100385800	SMD TRANS BC858B/BC857B
C 60509	851591104500	FOKO FKP1 680PF 10% 1600V	CT 40581	830100385800	SMD TRANS BC858B/BC857B
C 60512	865008111100	KERKO HV C 270PF 20% 2KV	CT 43010	830100385800	SMD TRANS BC858B/BC857B
C 60523	865008112500	KERKO HV C 1000PF 20% 1KV	CT 43015	830100484800	SMD TRANS BC848B/BC847B
C 60524	865008112500	KERKO HV C 1000PF 20% 1KV	CT 50005	830100484800	SMD TRANS BC848B/BC847B
C 60526	865008112500	KERKO HV C 1000PF 20% 1KV	CT 50015	830100484800	SMD TRANS BC848B/BC847B
C 60527	865008112500	KERKO HV C 1000PF 20% 1KV	CT 50040	830100484800	SMD TRANS BC848B/BC847B
C 61016	851591104000	FOKO FKP1 220PF 10% 1800V	CT 50050	830100484800	SMD TRANS BC848B/BC847B
C 61036	865006704600	KERKO HV C 100PF 20% 1KV	CT 50055	830100484800	SMD TRANS BC848B/BC847B
C 61056	865006704600	KERKO HV C 270PF 20% 1KV	CT 52260	830100385800	SMD TRANS BC858B/BC857B
C 62501	△ 851179301800	MP3 0,1UF 20% 250V	CT 57020	830100385800	SMD TRANS BC858B/BC857B
C 62521	△ 866009623800	KERKO SI 2200PF 20% 400V	CT 57021	830100385800	SMD TRANS BC858B/BC857B
C 62522	△ 866009623800	KERKO SI 2200PF 20% 400V	CT 57112	830100385800	SMD TRANS BC858B/BC857B
C 62548	△ 866009623400	KERKO SI 1000PF 20% 400V	CT 57113	830100385800	SMD TRANS BC858B/BC857B
C 81063	814054010400	EMIFIL 0,1 UF -GR	CT 57124	830100484800	SMD TRANS BC848B/BC847B
CD 80501	830940159200	SMD DIODE BA591	CT 61043	830100484800	SMD TRANS BC848B/BC847B
CT 61053	830100484800	SMD TRANS BC848B/BC847B			

ÄNDERUNGEN VORBEHALTEN / SUBJECT TO ALTERATION

POS. NR. POS. NO.	MATERIAL-NR. PART NUMBER	BEZEICHNUNG DESCRIPTION	POS. NR. POS. NO.	MATERIAL-NR. PART NUMBER	BEZEICHNUNG DESCRIPTION
CT 81220	830100484800	SMD TRANS BC848B/BC847B	L 81061	810498205100	FERRITPERLE HF55 BTL 3,5X FERRITE BEAD
CT 81225	830100484800	SMD TRANS BC848B/BC847B	L 81062	814052636100	DR 0411 10UH 5%
CT 85502	830100385800	SMD TRANS BC858B/BC857B	L 81064	814052636100	DR 0411 10UH 5% CHOKE
D 40584	830921504500	DIODE 1N4148	Q 34043	838212104400	QUARZ 4,433619 MHZ
D 40586	830921504500	DIODE 1N4148	Q 80001	838208004000	QUARZ 4 MHZ
D 43055	830921504500	DIODE 1N4148	Q 80951	838216204100	QUARZ 4 MHZ
D 43056	830921504500	DIODE 1N4148	R 40551	873229240700	DRW 4 1,8 OHM 10%
D 50023	830921502000	DIODE 1N4004	R 43006	870001124600	KSW 0204 75 OHM 5%
D 50048	830970301400	Z-DIODE ZPY5,6 2%	R 50048	△ 870552103300	MOW 0411 22 OHM 5%
D 52001	830921504500	DIODE 1N4148	R 50050	△ 870522705300	MOW 0411 150 OHM 5%
D 53003	830920100500	DIODE BA157	R 52004	△ 870552105300	MOW 0411 150 OHM 5%
D 54001	830920426800	DIODE BYV16	R 53002	△ 870042909700	KSW NB 0207 10 KOHM 5%
D 54011	830920100500	DIODE BA157	R 53009	871033814500	MGW AX 1 MOHM 5%
D 54022	830927033000	Z-DIODE 30B 0,5W	R 53011	△ 870552102100	MOW 0411 6,8 OHM 5%
D 57013	830921504500	DIODE 1N4148	R 53016	873018942500	DRW 9 10 OHM 10%
D 57023	830921504500	DIODE 1N4148	R 53021	△ 870522707100	MOW 0411 820 OHM 5%
D 60506	△ 830951685400	DIODE BYT54M	R 53033	△ 870552100500	MOW 0411 1,5 OHM 5%
D 60509	△ 830966318000	Z-DIODE BZT03D180	R 53033	△ 870552101300	MOW 0411 3,3 OHM 5%
D 60512	830951675400	DIODE BYT53B	R 53074	△ 870556107100	MOW 0617 820 OHM 5%
D 60523	830856038400	GLR.SKB380C1500	R 54001	△ 870552102500	MOW 0411 10 OHM 5%
D 61016	△ 830951717800	DIODE BYW178	R 54006	△ 870552100900	MOW 0411 2,2 OHM 5%
D 61036	△ 830951710800	DIODE BYT108-400	R 54022	△ 870556111100	MOW 0617 39 KOHM 5%
D 61056	△ 830951717200	DIODE BYW172D	R 60502	870006935600	KSW 0617 3 MOHM 2%
D 85001	830994460100	LE DIODE TLHR4601	R 60504	870006934700	KSW 0617 1,2 MOHM 2%
F 32109	860275504200	CER.TRAP 42	R 60508	△ 870556110500	MOW 0617 22 KOHM 5%
F 32410	814110760100	SPULE 7X7 #601 SIGN107601	R 60509	870556110500	MOW 0617 22 KOHM 5%
F 32412	831900198000	OFWFL J1980	R 60516	879005004600	ESTR.SK10-A 4,7 KOHM LIN
F 34052	814111675000	FILTER 7X7 #750 SIGN11675	R 61018	△ 870552111900	MOW 0411 82 KOHM 5%
IC 34015	830512524600	IC STV2246	R 62501	△ 831120001600	PTC DUO T251-A80-A10
IC 40550	830534726600	IC TDA7266B	R 62502	831100501700	NTC 4,7 OHM 30%
IC 50010	830533817500	IC TDA8174AW	R 62549	△ 876504916100	MSW SI 0414 4,7 MOHM VDE
IC 60510	830533464600	IC TDA16846	SI 40551	△ 831561902800	SI LOET T1,6A 250V
IC 61040	830520431700	IC LM317T	SI 62501	△ 831561700600	SI 5X20 T2,5A L 250V
IC 61050	830520431700	IC LM317T	T 52001	830328563700	TRANS BC637
IC 61060	830520570300	IC MC7805CT	T 53001	830290002000	TRANS S2055N
IC 80500	830521006500	IC MC33164P-SRP	T 60506	830280504000	TRANS IRFBC40
IC 80920	297980190100	IC 27C020 PROG.KPL	TR 52001	092468680400	TRAFO TREIBER TRANSFORMER DRIVER
WW.	297980190400	IC 27C020 PROG.KPL	TR 53010	△ 292210315700	TRAFO DIODEN-SPLIT 1,5 OHM TRANSFORMER DIODE SPLIT
IC 81500	830415506100	IC ST92195C9B1-S221	TR 53020	△ 292016651101	TRAFO DIODEN-SPLIT 3,3 OHM TRANSFORMER DIODE SPLIT
WW.	830415506200	IC ST92195C9B1-S222	TR 61000	△ 292015219700	SPERRWANDLERTRAFO B.O.TYPE CONVERTER TRANSFORMER
WW.	293052192500	PROZESSORPLATTE			
WW.	293052192700	PROZESSORPLATTE			
IC 84501	830536753000	IC TFM55300	L 31043	814052644000	DR ST 0411-GRP 8,2UH 10%
L 31043	814052644000	DR ST 0411-GRP 8,2UH 10%	L 32023	814052653000	DR 0411 33UH 10%
L 32023	814052653000	DR 0411 33UH 10%	L 32026	814052653000	DR 0411 33UH 10%
L 32026	814052653000	DR 0411 33UH 10%	L 32109	814052690600	DR 0309 4,7UH 10%
L 32109	814052690600	DR 0309 4,7UH 10%	L 40512	814050525900	DR A AX-GA 27UH 10%
L 40512	814050525900	DR A AX-GA 27UH 10%	L 52251	814051174900	DR AX 0411-GA 10UH 10%
L 52251	814051174900	DR AX 0411-GA 10UH 10%	L 52256	814052632000	DR AX 0411-GA 3,3UH 10% CHOKE
L 52256	814052632000	DR AX 0411-GA 3,3UH 10% CHOKE	L 53003	810498205600	FERRITPERLE HF70 BTL 3,5X FERRITE BEAD
L 53003	810498205600	FERRITPERLE HF70 BTL 3,5X FERRITE BEAD	L 53011	814050524900	DR A AX-GA 10UH 10%/CHOKE
L 53011	814050524900	DR A AX-GA 10UH 10%/CHOKE	L 53021	292031149500	LINEARITAETSREGLER LINEARITY CONTROL
L 53021	292031149500	LINEARITAETSREGLER LINEARITY CONTROL	L 53074	092468700101	ZB-SPULE/ZB COIL
L 53074	092468700101	ZB-SPULE/ZB COIL	L 60506	810498205700	FERRITPERLE 3,6UH 5720500
L 60506	810498205700	FERRITPERLE 3,6UH 5720500	L 61038	810498200300	FERRITPERLE BL02RN2-R62 FERRITE BEAD
L 61038	810498200300	FERRITPERLE BL02RN2-R62 FERRITE BEAD	L 62501	△ 295008269700	FUNKTENTSTOERDROSSEL INTERFERENCE CHOKE

Es gelten die Vorschriften und Sicherheitshinweise gemäß dem Service Manual "Sicherheit", Mat.-Nummer 720108000000, sowie zusätzlich die eventuell abweichenden, landesspezifischen Vorschriften!



The regulations and safety instructions shall be valid as provided by the "Safety" Service Manual, part number 720108000000, as well as the respective national deviations.

ÄNDERUNGEN VORBEHALTEN / SUBJECT TO ALTERATION

Ersatzteilliste
Spare Parts List

6 / 2001

CHASSIS-FS-STEREO CUC 2121 MULTI/DOLBY
CHASSIS TV STEREO CUC 2121 MULTI/DOLBY

MATERIAL-NR. / PART NO.: 297040133600

POS. NR. POS. NO.	ABB. FIG.	MATERIAL-NR. PART NUMBER	ANZ. QTY.	BEZEICHNUNG (D)	DESCRIPTION (GB)
		297040133600		CHASSIS-FS-STEREO CUC 2121 MULTI/DOLBY KEIN E-TEIL	CHASSIS TV STEREO CUC 2121 MULTI/DOLBY NO SPARE PART
0100.000		295043010100		TUNER-GLOBAL (PLL)	TUNER-GLOBAL (PLL)
0206.000		297006430104		ABDECKUNG EURO AV	COVER EURO AV
0216.000		297033571100		TASTSCHALTER PROGRAMM +	KEY SWITCH PROGRAMME +
0216.000		297033571100		TASTSCHALTER PROGRAMM -	KEY SWITCH PROGRAMME -
0216.000		297033571100		TASTSCHALTER LAUTSTAEKKE +	KEY SWITCH VOLUME +
0216.000		297033571100		TASTSCHALTER LAUTSTAEKKE -	KEY SWITCH VOLUME -
0240.000		293033904200		KOPFHOERERBUCHSE 3,5 O.SCHALTER	HEADPHONE SOCKET 3,5 W/O SWITCH
0241.000		293031680503		CINCH-BUCHSE 3-FACH FBAS/NF L,R	CINCH SOCKET 3 FOLD FBAS/AF L,R
0247.000		293031190603		EURO-AV BUCHSENLEISTE 21-POL SW	EURO-AV SOCKET STRIP 21 PIN BLACK
0500.000		295041028400	X	BAUSTEIN STEREO MODUL	STEREO MODULE
0910.000	△	292107030101		FOKUSLEITUNG	FOCUSING CABLE
1000.000	△	096211130206	2	SICHERUNGSHALTER Si62501	FUSE HOLDER Si62501
2000.000	△	297033910600		NETZSCHALTER O.WISCHER	POWER SWITCH W/O WIPER
2200.000	△	293033995100		NETZ EINBAUGERAETESTECKER	APPLIANCE COUPLER
2400.000		293031530107		MONTAGECLIP IC40550	MOUNTING CLIP IC40550
2410.000		293031530208	2	MONTAGECLIP IC50010/T53001	MOUNTING CLIP IC50010/T53001
2420.000		293031531600		MONTAGECLIP T60506	MOUNTING CLIP T60506
2430.000		293031531605	3	MONTAGECLIP IC61040/61050/61060	MOUNTING CLIP IC61040/61050/61060
2450.000		293031562000	4	FOLIE WAERMELEITEND IC61040/61050/61060/T60506	FOIL HEAT CONDUCTING IC61040/61050/61060/T60506
				X = SIEHE GESONDERTE E-LISTE WW. = WAHLWEISE	X = SEE SEPARATE PARTS LIST WW. = OPTIONAL

POS. NR. POS. NO.	MATERIAL-NR. PART NUMBER	BEZEICHNUNG DESCRIPTION	POS. NR. POS. NO.	MATERIAL-NR. PART NUMBER	BEZEICHNUNG DESCRIPTION
C 34026	845296706400	ELKO 1000UF 10V	CD 34041	830940159200	SMD DIODE BA591
C 40557	845299610700	ELKO 2200UF 20% 16V	CD 80501	830940159200	SMD DIODE BA591
C 50047	845299618700	ELKO 1000UF 20% 35V			
C 50048	845299864700	ELKO 1000UF 20% 25V	CIC80910	830581409400	SMD IC MC14094BD
C 53002	851591111400	FOKO KF #35 9000PF 3,5% 1500V	CIC80930	830595012900	SMD IC ST92R195C9Q1
C 54011	865006704600	KERKO HV C 100PF 20% 1KV	CIC82501	830596000800	SMD IC M24C08CM1TR
C 54012	845299618700	ELKO 1000UF 20% 35V			
C 60501	865008112500	KERKO HV C 1000PF 20% 1KV	CL 40511	810498233100	SMD DAEMPF-PERLE 0805 BLM
C 60509	851591104500	FOKO FKP1 680PF 10% 1600V			
C 60512	865008111100	KERKO HV C 270PF 20% 2KV	CT 32111	830100484800	SMD TRANS BC848B/BC847B
C 60523	865008112500	KERKO HV C 1000PF 20% 1KV	CT 32122	830100385800	SMD TRANS BC858B/BC857B
C 60524	865008112500	KERKO HV C 1000PF 20% 1KV	CT 32123	830100484800	SMD TRANS BC848B/BC847B
C 60526	865008112500	KERKO HV C 1000PF 20% 1KV	CT 32124	830100385800	SMD TRANS BC858B/BC857B
C 60527	865008112500	KERKO HV C 1000PF 20% 1KV	CT 32132	830100484800	SMD TRANS BC848B/BC847B
C 61036	865006704600	KERKO HV C 100PF 20% 1KV	CT 32460	830100484800	SMD TRANS BC848B/BC847B
C 61056	865006704600	KERKO HV C 100PF 20% 1KV	CT 32470	830100484800	SMD TRANS BC848B/BC847B
C 62501	△ 851179301800	MP3 0,1UF 20% 250V	CT 32480	830100484800	SMD TRANS BC848B/BC847B
C 62521	△ 866009623800	KERKO SI 2200PF 20% 400V	CT 34031	830100385800	SMD TRANS BC858B/BC857B
C 62522	△ 866009623800	KERKO SI 2200PF 20% 400V	CT 40581	830100385800	SMD TRANS BC858B/BC857B
C 62548	△ 866009623400	KERKO SI 1000PF 20% 400V	CT 43010	830100385800	SMD TRANS BC858B/BC857B
C 81063	814054010400	EMFIFIL 0,1 UF -GR	CT 43015	830100484800	SMD TRANS BC848B/BC847B
			CT 50005	830100484800	SMD TRANS BC848B/BC847B
CD 32411	830940159200	SMD DIODE BA591	CT 50015	830100484800	SMD TRANS BC848B/BC847B
CD 32460	830940159200	SMD DIODE BA591	CT 50040	830100484800	SMD TRANS BC848B/BC847B
CD 32470	830940159200	SMD DIODE BA591	CT 50050	830100484800	SMD TRANS BC848B/BC847B

ÄNDERUNGEN VORBEHALTEN / SUBJECT TO ALTERATION

GRUNDIG

TV

POS. NR. POS. NO.	MATERIAL-NR. PART NUMBER	BEZEICHNUNG DESCRIPTION	POS. NR. POS. NO.	MATERIAL-NR. PART NUMBER	BEZEICHNUNG DESCRIPTION
CT 50055	830100484800	SMD TRANS BC848B/BC847B	L 53021	292031149500	LINEARITAETSREGLER
CT 52260	830100385800	SMD TRANS BC858B/BC857B			LINEARITY CONTROL
CT 57020	830100385800	SMD TRANS BC858B/BC857B	L 53074	092468700101	ZB-SPULE
CT 57021	830100385800	SMD TRANS BC858B/BC857B			ZB COIL
CT 57112	830100385800	SMD TRANS BC858B/BC857B	L 60506	810498205700	FERRITPERLE 3,6UH
CT 57113	830100385800	SMD TRANS BC858B/BC857B	L 61038	810498200300	FERRITPERLE BL02RN2-R62
CT 57124	830100484800	SMD TRANS BC848B/BC847B			FERRITE BEAD
CT 61043	830100484800	SMD TRANS BC848B/BC847B	L 62501	△ 295008269700	FUNKTENTSTOERDROSSEL
CT 61053	830100484800	SMD TRANS BC848B/BC847B			INTRFERENCE CHOKE
CT 81220	830100484800	SMD TRANS BC848B/BC847B	L 81061	810498205100	FERRITPERLE HF55 BTL 3,5X4,5
CT 81225	830100484800	SMD TRANS BC848B/BC847B			FERRITE BEAD
CT 85502	830100385800	SMD TRANS BC858B/BC857B	L 81062	814052636100	DR 0411 10UH 5%
			L 81064	814052636100	DR 0411 10UH 5% CHOKE
D 40584	830921504500	DIODE 1N4148	Q 34043	838212104400	QUARZ 4,433619 MHZ
D 40586	830921504500	DIODE 1N4148	Q 34044	838204900300	QUARZ 3,579545MHZ
D 43055	830921504500	DIODE 1N4148	Q 80001	838208004000	QUARZ 4 MHZ
D 43056	830921504500	DIODE 1N4148	Q 80951	838216204100	QUARZ 4 MHZ
D 50023	830921502000	DIODE 1N4004			
D 50048	830970301400	Z-DIODE ZPY5,6 2%	R 40551	873229240700	DRW 4 1,8 OHM 10%
D 52001	830921504500	DIODE 1N4148	R 43006	870001124600	KSW 0204 75 OHM 5%
D 53003	830920100500	DIODE BA157	R 50048	△ 870552103300	MOW 0411 22 OHM 5%
D 54001	830920426800	DIODE BYV16	R 52004	△ 870552105300	MOW 0411 150 OHM 5%
D 54011	830920100500	DIODE BA157	R 53002	△ 870042909700	KSW NB 0207 10 KOHM 5%
D 54022	830972033000	Z-DIODE 30B 0,5W	R 53009	871033814500	MGW AX 1 MOHM 5%
D 57013	830921504500	DIODE 1N4148	R 53011	△ 870552102100	MOW 0411 6,8 OHM 5%
D 57023	830921504500	DIODE 1N4148	R 53016	873018942500	DRW 9 10 OHM 10%
D 60506	△ 830951685400	DIODE BYT54M	R 53021	△ 870522707100	MOW 0411 820 OHM 5%
D 60509	△ 830966318000	Z-DIODE BZT03D180	R 53033	△ 870552101300	MOW 0411 3,3 OHM 5%
D 60512	830951675400	DIODE BYT53B	R 53033	△ 870552100500	MOW 0411 1,5 OHM 5%
D 60523	830856038400	GLR.SKB380C1500	R 53074	△ 870556107100	MOW 0617 820 OHM 5%
D 61016	△ 830951717800	DIODE BYW178	R 54001	△ 870552102500	MOW 0411 10 OHM 5%
D 61036	△ 830951710800	DIODE BYT108-400	R 54022	△ 870556111100	MOW 0617 39 KOHM 5%
D 61056	△ 830951717200	DIODE BYW172D	R 60502	870006935600	KSW 0617 3 MOHM 2%
D 85001	830994460100	LE DIODE TLHM4601	R 60504	870006934700	KSW 0617 1,2 MOHM 2%
F 32109	860275506600	KERTRAP #66 5,5/6,6,5MHZ	R 60508	△ 870556110500	MOW 0617 22 KOHM 5%
F 32121	814111136000	FILTER 7X7 360	R 60509	△ 870556110500	MOW 0617 22 KOHM 5%
F 32410	814053445100	SPULE 7X7 #451	R 60516	879005004600	ESTR.SK10-A 4,7 KOHM LIN
F 32412	831900395300	OFWFL K3953M	R 61018	△ 870552111900	MOW 0411 82 KOHM 5%
F 32430	831900465400	OFWFL K4654K	R 62501	△ 831120001600	PTC DUO T251-A80-A10
F 34052	814111675000	FILTER 7X7 #750	R 62502	△ 831100501700	NTC 4,7 OHM 30%
			R 62549	△ 876504916100	MSW SI 0414 4,7 MOHM VDE
IC 34015	830512524800	IC STV2248	SI 40551	△ 831561902800	SI LOET T1,6A 250V
IC 40550	830534726600	IC TDA7266B	SI 62501	△ 831561700600	SI 5X20 T2,5A L 250V
IC 50010	830533817500	IC TDA8174AW	T 52001	830328563700	TRANS BC637
IC 60510	830533464600	IC TDA16846	T 53001	830290002000	TRANS S2055N
IC 61040	830520431700	IC LM317T	T 60506	830280504000	TRANS IRFBC40
IC 61050	830520431700	IC LM317T			
IC 61060	830520570300	IC MC7805CT	TR 52001	092468680400	TRAFO TREIBER
IC 80500	830521006500	IC MC33164P-5RP			TRANSFORMER DRIVER
IC 81500	293052193000	PROZESSORPLATTE 7-S. TEXT	TR 53010	△ 292210315700	TRAFO DIODEN-SPLIT
WW.	830415507200	IC ST92195C9B1-S232 7-S. TEXT			TRANSFORMER DIODE SPLIT
IC 80920	297980200400	IC 27C020 PROG.KPL 7-S. TEXT			TRANSFORMER DIODE SPLIT
IC 81500	293052192600	PROZESSORPLATTE 8-S. TEXT			TRAFO DIODEN-SPLIT
WW.	830415507100	IC ST92195C9B1-S231 8-S. TEXT			TRANSFORMER DIODE SPLIT
IC 80920	297980200200	IC 27C020 PROG.KPL 8-S. TEXT	TR 53020	△ 292016651101	TRAFO DIODEN-SPLIT
IC 84501	8305461133000	IC TSOP11330			TRANSFORMER DIODE SPLIT
L 31043	814052644000	DR ST 0411-GRP 8,2UH 10%			R 53033 = 3,3 OHM
L 32109	814052690600	DR 0309 4,7UH 10%	TR 61000	△ 292015219700	SPERRWANDLERTRAFO
L 40512	814050525900	DR AX AX 6,7UH 10%			B.O.TYPE CONVERTER
L 52251	814051174900	DR AX 0411-GA 10UH 10%			TRANSFORMER
L 52256	814052632000	DR AX 0411-GA 3,3UH 10%/CHOKE			
L 53003	810498205600	FERRITPERLE HF70 BTL 3,5X6			
		FERRITE BEAD			
L 53011	814050524900	DR A AX-GA 10UH 10% CHOKE			

Es gelten die Vorschriften und Sicherheitshinweise gemäß dem Service Manual "Sicherheit", Mat.-Nummer 720108000000, sowie zusätzlich die eventuell abweichenden, landesspezifischen Vorschriften!



The regulations and safety instructions shall be valid as provided by the "Safety" Service Manual, part number 720108000000, as well as the respective national deviations.

ÄNDERUNGEN VORBEHALTEN / SUBJECT TO ALTERATION

Ersatzteilliste Spare Parts List

3 / 2002

CHASSIS-FS-STEREO CUC 2121 GB DOLBY CHASSIS TV STEREO CUC 2121 GB DOLBY

MATERIAL-NR. / PART NO.: 297040133700

POS. NR. POS. NO.	ABB. FIG.	MATERIAL-NR. PART NUMBER	ANZ. QTY.	BEZEICHNUNG (D)	DESCRIPTION (GB)
		297040133700		CHASSIS-FS-STEREO CUC 2121 GB DOLBY KEIN E-TEIL	CHASSIS TV STEREO CUC 2121 GB DOLBY NO SPARE PART
0100.000		295043010400		TUNER-GLOBAL (PLL)	TUNER-GLOBAL (PLL)
0215.000		297033571100		TASTSCHALTER PROGRAMM +	KEY SWITCH PROGRAMME +
0215.000		297033571100		TASTSCHALTER PROGRAMM -	KEY SWITCH PROGRAMME -
0215.000		297033571100		TASTSCHALTER LAUTSTAERKE +	KEY SWITCH VOLUME +
0215.000		297033571100		TASTSCHALTER LAUTSTAERKE -	KEY SWITCH VOLUME -
0240.000		293033904200		KOPFHÖRERBUCHSE 3,5mm O.SCHALTER	HEADPHONE SOCKET 3,5mm W/O SWITCH
0241.000		293031680503		CINCH-BUCHSE 3-FACH FBAS/NF L,R	CINCH SOCKET 3 FOLD FBAS/AF L,R
0247.000		293031190603		EURO-AV BUCHSENLEISTE 21-POL SW	EURO-AV SOCKET STRIP 21 PIN BLACK
0312.000		297006430104		ABDECKUNG EURO-AV	COVER EURO AV
0500.000		295041028400	X	BAUSTEIN STEREO	STEREO MODULE
0910.000	△	292107030100		FOKUSLEITUNG	FOCUSING CABLE
1000.000	△	096211130206	2	SICHERUNGSHALTER S162501	FUSE HOLDER S162501
2000.000	△	297033910600		NETZSCHALTER O.WISCHER	POWER SWITCH W/O WIPER
2200.000	△	293033995100		NETZ EINBAUGERAETESTECKER	APPLIANCE COUPLER
2400.000		293031530107		MONTAGECLIP IC40550	MOUNTING CLIP IC40550
2410.000		293031530208	2	MONTAGECLIP T53001/IC50010	MOUNTING CLIP T53001/IC50010
2440.000		293031531600		MONTAGECLIP T60506	MOUNTING CLIP T60506
2445.000		293031531605	3	MONTAGECLIP IC61040/61050/61060	MOUNTING CLIP IC61040/61050/61060
2470.000		293031562000	4	FOLIE WAERMELEITEND T60506/ IC61040/61050/61060	FOIL HEAT CONDUCTING T60506/ IC61040/61050/61060
				X = SIEHE GESONDERTE E-LISTE WW. = WAHLWEISE	X = SEE SEPARATE PARTS LIST WW. = OPTIONAL

POS. NR. POS. NO.	MATERIAL-NR. PART NUMBER	BEZEICHNUNG DESCRIPTION	POS. NR. POS. NO.	MATERIAL-NR. PART NUMBER	BEZEICHNUNG DESCRIPTION
C 34026	845296706400	ELKO 1000UF +50-20% 10V	CIC 80910	830581409400	SMD IC MC14094BD
C 40557	845299610700	ELKO 2200UF 20% 16V	CIC 80930	830595012900	SMD IC ST92R195C9Q1
C 50047	845299618700	ELKO 1000UF 20% 35V	CIC 82501	830596000800	SMD IC M24C08CM1TR
C 50048	845299664700	ELKO 1000UF 20% 25V			
C 53002	851591111400	FOKO KF #35 9000PF 3,5% 1500V	CL 40511	810498233100	SMD DAEMPF-PERLE 0805 BLM
C 54011	865006704600	KERKO HV C 100PF 20% 1KV			
C 54012	845299618700	ELKO 1000UF 20% 35V			
C 60501	865008112500	KERKO HV C 1000PF 20% 1KV	CT 32124	830100385800	SMD TRANS BC858B/BC857B
C 60509	851591104500	FOKO FKP1 680PF 10% 1600V	CT 34031	830100385800	SMD TRANS BC858B/BC857B
C 60512	865008111100	KERKO HV C 270PF 20% 2KV	CT 40581	830100385800	SMD TRANS BC858B/BC857B
C 60523	865008112500	KERKO HV C 1000PF 20% 1KV	CT 43010	830100385800	SMD TRANS BC858B/BC857B
C 60524	865008112500	KERKO HV C 1000PF 20% 1KV	CT 43015	830100484800	SMD TRANS BC848B/BC847B
C 60526	865008112500	KERKO HV C 1000PF 20% 1KV	CT 50005	830100484800	SMD TRANS BC848B/BC847B
C 60527	865008112500	KERKO HV C 1000PF 20% 1KV	CT 50015	830100484800	SMD TRANS BC848B/BC847B
C 61016	851591104000	FOKO FKP1 220PF 10% 1600V	CT 50040	830100484800	SMD TRANS BC848B/BC847B
C 61036	865006704600	KERKO HV C 100PF 20% 1KV	CT 50050	830100484800	SMD TRANS BC848B/BC847B
C 61056	865006704600	KERKO HV C 100PF 20% 1KV	CT 50055	830100484800	SMD TRANS BC848B/BC847B
C 62501	851179301800	FOKO MP3 0,1UF 20% 275V	CT 52260	830100385800	SMD TRANS BC858B/BC857B
C 62521	866009623800	KERKO SI 2200PF 20% 400V	CT 57020	830100385800	SMD TRANS BC858B/BC857B
C 62522	866009623800	KERKO SI 2200PF 20% 400V	CT 57021	830100385800	SMD TRANS BC858B/BC857B
C 62549	866009623400	KERKO SI 1000PF 20% 400V	CT 57112	830100385800	SMD TRANS BC858B/BC857B
C 81063	814054010400	EMIFIL 0,1 UF -GR	CT 57113	830100385800	SMD TRANS BC858B/BC857B
CD 80501	830940159200	SMD DIODE BA591	CT 57124	830100484800	SMD TRANS BC848B/BC847B
			CT 61043	830100484800	SMD TRANS BC848B/BC847B

ÄNDERUNGEN VORBEHALTEN / SUBJECT TO ALTERATION

GRUNDIG

TV

POS. NR. POS. NO.	MATERIAL-NR. PART NUMBER	BEZEICHNUNG DESCRIPTION	POS. NR. POS. NO.	MATERIAL-NR. PART NUMBER	BEZEICHNUNG DESCRIPTION
CT 61053	830100484800	SMD TRANS BC848B/BC847B	L 81061	810498205100	FERRITPERLE HF55 BTL 3,5X FERRITE BEAD
CT 81220	830100484800	SMD TRANS BC848B/BC847B	L 81062	814052636100	DR 0411 10UH 5%
CT 81225	830100484800	SMD TRANS BC848B/BC847B	L 81064	814052636100	DR 0411 10UH 5% CHOKE
CT 85502	830100385800	SMD TRANS BC858B/BC857B			
D 40584	830921504500	DIODE 1N4148	Q 34043	838212104400	QUARZ 4,433619MHZ
D 40586	830921504500	DIODE 1N4148	Q 80001	838208004000	QUARZ 4MHZ
D 43055	830921504500	DIODE 1N4148	Q 80951	838216204100	QUARZ 4MHZ
D 43056	830921504500	DIODE 1N4148			
D 50023	830921502000	DIODE 1N4004	R 40551	873229240700	DRW 4 1,8 OHM 10%
D 50048	830970301400	Z-DIODE ZPY5,6 2%	R 43006	870001124600	KSW 0204 7,5 OHM 5%
D 52001	830921504500	DIODE 1N4148	R 50047	876642460200	MSW 0207 1,1 OHM 1%
D 53003	830920100500	DIODE BA157	R 50048	870552103300	MOW 0411 22 OHM 5%
D 54001	830920426800	DIODE BYV16	R 50050	870522705300	MOW 0411 150 OHM 5%
D 54011	830920100500	DIODE BA157	R 52004	870552105300	MOW 0411 150 OHM 5%
D 54022	830972033000	Z-DIODE 30B 0,5W	R 53002	870042909700	KSW NE 0207 1,0 KOHM 5%
D 57013	830921504500	DIODE 1N4148	R 53009	871033814500	MGW AX 1 MOHM 5%
D 57023	830921504500	DIODE 1N4148	R 53011	870552102100	MOW 0411 6,8 OHM 5%
D 60506	830951685400	DIODE BYT54M	R 53016	873018942500	DRW 9 10 OHM 10%
D 60509	830966318000	Z-DIODE BZT03D180	R 53021	870522707100	MOW 0411 820 OHM 5%
D 60512	830951675400	DIODE BYT53B	R 53033	870552100500	MOW 0411 1,5 OHM 5%
D 60523	830856038400	GLR.SKB380C1500	R 53074	870556107100	MOW 0617 820 OHM 5%
D 61016	830951717800	DIODE BYW178	R 54001	870552102500	MOW 0411 10 OHM 5%
D 61036	830951710800	DIODE BYE1108-400	R 54006	870552100900	MOW 0411 2,2 OHM 5%
D 61056	830951717200	DIODE BYW172D	R 54022	870556111100	MOW 0617 39 KOHM 5%
D 85001	830994460100	LE DIODE TLHR4601	R 60502	870006935600	KSW 0617 3 MOHM 2%
F 32109	860275654200	KERTRAP #542 6MHZ	R 60504	870006934700	KSW 0617 1,2 MOHM 2%
F 32410	814110760100	SPULE 7X7 #601 SIGN107601	R 60508	870556110500	MOW 0617 22 KOHM 5%
F 32412	831900198000	OFWFIL J1980 SIE	R 60509	870556110500	MOW 0617 22 KOHM 5%
F 34052	814111675000	FILTER 7X7 #750 SIGN11675	R 60516	879005004600	ESTR.SK10-A 4,7 KOHM LIN
IC 34015	830512524600	IC STV2246	R 61018	870552111900	MOW 0411 82 KOHM 5%
IC 40550	830534726600	IC TDA7266B	R 62501	831120001600	PTC DUO T251-A80-A10
IC 50010	830533817500	IC TDA8174AW	R 62502	831100501700	NTC 4,7 OHM 30%
IC 60510	830533464600	IC TDA16846	R 62549	876504916100	MSW SI 0414 0,7 MOHM
IC 61040	830520431700	IC LM317T	SI 40551	831561902800	SI LOET T1,6A 250V
IC 61050	830520431700	IC LM317T	SI 62501	831561700600	SI 5X20 T2,5A L 250V
IC 61060	830520570300	IC MC7805CT	T 52001	830328563700	TRANS BC637
IC 80500	830521006500	IC MC33164P-5RP	T 53001	830290002000	TRANS S2055N
IC 80920	297980190400	IC 27C020 PROG.KPL	T 60506	830280504000	TRANS IRFBC40
IC 81500	293052192700	PROZESSORPLATTE			
WW.	830415506200	IC ST92195C9B1-S222	TR 52001	092468680400	TRAFO TREIBER TRANSFORMER DRIVER
IC 84501	830546133000	IC TSOP1330	TR 53010	292210315700	TRAFO DIODEN-SPLIT TRAFO DIODEN-SPLIT
			WW. △	292016651101	TRAFO DIODEN-SPLIT TRANSFORMER DIODE SPLIT
L 31043	814052644000	DR ST 0411-GRP 8,2UH 10%	TR 61000	292015219703	SPERRWANDLERTRAFO B.O.TYPER CONVERTER
L 32023	814052653000	DR 0411 33UH 10%			
L 32026	814052653000	DR 0411 33UH 10%			
L 32109	814052690600	DR 0309 4,7UH 10%			
L 40512	814050525900	DR A AX-GA 27UH 10%			
L 52251	814051174900	DR AX 0411-GA 10UH 10%			
L 52256	814052632000	DR AX 0411-GA 3,3UH 10% CHOKE			
L 53003	810498205600	FERRITPERLE HF70 BTL 3,5X FERRITE BEAD			
L 53011	814050524900	DR A AX-GA 10UH 10% CHOKE			
L 53021	292031149500	LINEARITAETSREGLER LINEARITY CONTROL			
L 53074	092468700101	ZB-SPULE ZB COIL			
L 60506	810498205700	FERRITPERLE 3,6UH 5720500			
L 61038	810498200300	FERRITPERLE BL02RN2-R62 FERRITE BEAD			
L 62501	295008269700	FUNKENTSTOERDROSSEL INTERFERENCE CHOKE			

Es gelten die Vorschriften und Sicherheitshinweise gemäß dem Service Manual "Sicherheit", Mat.-Nummer 720108000000, sowie zusätzlich die eventuell abweichenden, landesspezifischen Vorschriften!



The regulations and safety instructions shall be valid as provided by the "Safety" Service Manual, part number 720108000000, as well as the respective national deviations.

ÄNDERUNGEN VORBEHALTEN / SUBJECT TO ALTERATION

Ersatzteilliste
Spare Parts List

12 / 2001

CHASSIS-FS-STEREO CUC 2121 MULTI/DOLBY
CHASSIS TV STEREO CUC 2121 MULTI/DOLBY

MATERIAL-NR. / PART NO.: 297040133800

POS. NR. POS. NO.	ABB. FIG.	MATERIAL-NR. PART NUMBER	ANZ. QTY.	BEZEICHNUNG (D)	DESCRIPTION (GB)
		297040133800		CHASSIS-FS-STEREO CUC 2121 MULTI/DOLBY KEIN E-TEIL	CHASSIS TV STEREO CUC 2121 MULTI/DOLBY NO SPARE PART
0100.000		295043010100		TUNER-GLOBAL (PLL)	TUNER GLOBAL (PLL)
0206.000		297006430104		ABDECKUNG EURO-AV	COVER EURO AV
0216.000		297033571100		TASTSCHALTER PROGRAMM +	KEY SWITCH PROGRAMME +
0216.000		297033571100		TASTSCHALTER PROGRAMM -	KEY SWITCH PROGRAMME -
0216.000		297033571100		TASTSCHALTER LAUTSTÄERKE +	KEY SWITCH VOLUME +
0216.000		297033571100		TASTSCHALTER LAUTSTÄERKE -	KEY SWITCH VOLUME -
0240.000		293033904200		KOPFHOERERBUCHSE 3,5mm O.SCHALTER	HEADPHONE SOCKET 3,5mm W/O SWITCH
0241.000		293031680503		CINCH-BUCHSE 3-FACH FBAS/NF L,R	CINCH SOCKET 3 FOLD FBAS/AF L,R
0247.000		293031190603		EURO-AV BUCHSENLEISTE 21-POL SW	EURO-AV SOCKET STRIP 21 PIN BLACK
0500.000		295041028400	X	BAUSTEIN STEREO	STEREO MODULE
0910.000	△	292107030100		FOKUSLEITUNG	FOCUSING CABLE
1000.000	△	096211130206	2	SICHERUNGSHALTER SI62501	FUSE HOLDER SI62501
2000.000	△	297033910600		NETZSCHALTER O.WISCHER	POWER SWITCH W/O WIPER
2200.000	△	293033995100		NETZ EINBAUGERAETESTECKER	APPLIANCE COUPLER
2400.000		293031530107		MONTAGECLIP IC40550	MOUNTING CLIP IC40550
2410.000		293031530208	2	MONTAGECLIP T53001/IC50010	MOUNTING CLIP T53001/IC50010
2440.000		293031531600		MONTAGECLIP T60506	MOUNTING CLIP T60506
2445.000		293031531605	3	MONTAGECLIP IC61040/61050/61060	MOUNTING CLIP IC61040/61050/61060
2470.000		293031562000	4	FOLIE WAERMELEITEND IC61040/61050/61060/T60506	FOIL HEAT CONDUCTING IC61040/61050/61060/T60506
				X = SIEHE GESONDERTE E-LISTE WW. = WAHLWEISE	X = SEE SEPARATE PARTS LIST WW. = OPTIONAL

POS. NR. POS. NO.	MATERIAL-NR. PART NUMBER	BEZEICHNUNG DESCRIPTION	POS. NR. POS. NO.	MATERIAL-NR. PART NUMBER	BEZEICHNUNG DESCRIPTION
C 34026	845296706400	ELKO 1000UF +50-20% 10V	CD 32460	830940159200	SMD DIODE BA591
C 40557	845299610700	ELKO 2200UF 20% 16V	CD 32470	830940159200	SMD DIODE BA591
C 50047	845299618700	ELKO 1000UF 20% 35V	CD 34041	830940159200	SMD DIODE BA591
C 50048	845299684700	ELKO 1000UF 20% 25V	CD 80501	830940159200	SMD DIODE BA591
C 83002	851591111400	FOKO KF #35 9000PF 3,5% 1500V			
C 54011	865006704600	KERKO HV C 100PF 20% 1KV	CIC 80910	830581409400	SMD IC MC14094BD
C 54012	845299618700	ELKO 1000UF 20% 35V CB	CIC 80930	830595012900	SMD IC ST92R195C9Q1
C 60501	865008112500	KERKO HV C 1000PF 20% 1K	CIC 82501	830596000800	SMD IC M24C08CM1TR
C 60509	851591104500	FOKO FKP1 680PF 10% 1600V			
C 60512	865008111100	KERKO HV C 270PF 20% 2KV	CL 40511	810498233100	SMD DAEMPF-PERLE 0805 BLM
C 60523	865008112500	KERKO HV C 1000PF 20% 1KV			
C 60524	865008112500	KERKO HV C 1000PF 20% 1KV	CT 32111	830100484800	SMD TRANS BC848B/BC847B
C 60526	865008112500	KERKO HV C 1000PF 20% 1KV	CT 32122	830100385800	SMD TRANS BC858B/BC857B
C 60527	865008112500	KERKO HV C 1000PF 20% 1KV	CT 32123	830100484800	SMD TRANS BC848B/BC847B
C 61016	851591104000	FOKO FKP1 220PF 10% 1600V	CT 32124	830100385800	SMD TRANS BC858B/BC857B
C 61036	865006704600	KERKO HV C 100PF 20% 1KV	CT 32132	830100484800	SMD TRANS BC848B/BC847B
C 61056	865006704600	KERKO HV C 100PF 20% 1KV	CT 32460	830100484800	SMD TRANS BC848B/BC847B
C 62501 △	851179301800	FOKO MP3 0,1UF 20% 275V	CT 32470	830100484800	SMD TRANS BC848B/BC847B
C 62521 △	866009623800	KERKO SI 2200PF 20% 400V	CT 32480	830100484800	SMD TRANS BC848B/BC847B
C 62522 △	866009623800	KERKO SI 2200PF 20% 400V	CT 34031	830100385800	SMD TRANS BC858B/BC857B
C 62549 △	866009623400	KERKO SI 1000PF 20% 400V	CT 40581	830100385800	SMD TRANS BC858B/BC857B
C 81063	814054010400	EMIFIL 0,1 UF -GR	CT 43010	830100385800	SMD TRANS BC858B/BC857B
			CT 43015	830100484800	SMD TRANS BC848B/BC847B
CD 32411	830940159200	SMD DIODE BA591	CT 50005	830100484800	SMD TRANS BC848B/BC847B

ÄNDERUNGEN VORBEHALTEN / SUBJECT TO ALTERATION

POS. NR. POS. NO.	MATERIAL-NR. PART NUMBER	BEZEICHNUNG DESCRIPTION	POS. NR. POS. NO.	MATERIAL-NR. PART NUMBER	BEZEICHNUNG DESCRIPTION
CT 50015	830100484800	SMD TRANS BC848B/BC847B	L 53003	810498205600	FERRITERPERLE HF70 BTL 3,5X
CT 50040	830100484800	SMD TRANS BC848B/BC847B			FERRITE BEAD
CT 50050	830100484800	SMD TRANS BC848B/BC847B	L 53011	814050524900	DR A AX-GA 10UH 10%
CT 50055	830100484800	SMD TRANS BC848B/BC847B			CHOKE
CT 52260	830100385800	SMD TRANS BC858B/BC857B	L 53021	292031149500	LINEARITAETSREGLER
CT 57020	830100385800	SMD TRANS BC858B/BC857B			LINEARITY CONTROL
CT 57021	830100385800	SMD TRANS BC858B/BC857B	L 53074	092468700101	ZB-SPULE/ZB COIL
CT 57112	830100385800	SMD TRANS BC858B/BC857B	L 60506	810498205700	FERRITERPERLE 3,6UH 5720500
CT 57113	830100385800	SMD TRANS BC858B/BC857B	L 61038	810498200300	FERRITERPERLE BL02RN2-R62
CT 57124	830100484800	SMD TRANS BC848B/BC847B			FERRITE BEAD
CT 61043	830100484800	SMD TRANS BC848B/BC847B	L 62501 △	295008269700	FUNKENTSTOERDROSSEL
CT 61053	830100484800	SMD TRANS BC848B/BC847B			INTERFERENCE CHOKE
CT 81220	830100484800	SMD TRANS BC848B/BC847B	L 81061	810498205100	FERRITERPERLE HF55 BTL 3,5X
CT 81225	830100484800	SMD TRANS BC848B/BC847B			FERRITE BEAD
CT 85502	830100385800	SMD TRANS BC858B/BC857B	L 81062	814052636100	DR 0411 10UH 5%
			L 81064	814052636100	DR 0411 10UH 5%
D 40584	830921504500	DIODE 1N4148			CHOKE
D 40586	830921504500	DIODE 1N4148			
D 43055	830921504500	DIODE 1N4148	Q 34043	838212104400	QUARZ 4,433619MHZ
D 43056	830921504500	DIODE 1N4148	Q 34044	838204900300	QUARZ 3,579545MHZ
D 50023	830921502000	DIODE 1N4004	Q 80001	838208004000	QUARZ 4MHZ
D 50048	830970301400	Z-DIODE ZPY5,6 2%	Q 80951	838216204100	QUARZ 4MHZ LING8-638
D 52001	830921504500	DIODE 1N4148			
D 53003	830920100500	DIODE BA157	R 40551	873229240700	DRW 4 1,8 OHM 10%
D 54001	830920426800	DIODE BYV16	R 43006	870001124600	KSW 0204 75 OHM 5%
D 54011	830920100500	DIODE BA157	R 50047	876642460200	MSW 0207 1,1 OHM 1%
D 54022	830972033000	Z-DIODE 30B 0,5W	R 50048 △	870552103300	MOW 0411 820 OHM 5%
D 57013	830921504500	DIODE 1N4148	R 50050 △	870522705300	MOW 0411 150 OHM 5%
D 57023	830921504500	DIODE 1N4148	R 52004 △	870552105300	MOW 0411 150 OHM 5%
D 60506 △	830951685400	DIODE BYT54M	R 53002 △	870042909700	KSW NB 0207 10 KOHM 5%
D 60509 △	830966318000	Z-DIODE BZT03D180	R 53009	871033814500	MGW AX 1 MOHM 5%
D 60512	830951675400	DIODE BYT53B	R 53011 △	870552102100	MOW 0411 6,8 OHM 5%
D 60523	830856038400	GLR.SK3B30C1500	R 53016	873018942500	DRW 9 10 OHM 10%
D 61016 △	830951717800	DIODE BYW170	R 53021 △	870522707100	MOW 0411 820 OHM 5%
D 61036 △	830951710800	DIODE BYT108-400	R 53033 △	870552100500	MOW 0411 1,5 OHM 5%
D 61056 △	830951717200	DIODE BYW172D	R 53074 △	870556107100	MOW 0617 820 OHM 5%
D 85001 △	830994460100	LE DIODE TLH4601	R 54001 △	870552102500	MOW 0411 10 OHM 5%
			R 54006 △	870552100900	MOW 0411 2,2 OHM 5%
F 32109	860275506600	KERTRAP #66 5,5/6,5MHZ	R 54022 △	870556111100	MOW 0617 39 KOHM 5%
F 32121	814111136000	FILTER 7X7 360 SIGN 11136	R 60502	870006935600	KSW 0617 3 MOHM 2%
F 32410	814053445100	SPULE 7X7 #451 SIGN534451	R 60504	870006934700	KSW 0617 1,2 MOHM 2%
F 32412	831900395300	OFWFL K3953M	R 60508 △	870556110500	MOW 0617 22 KOHM 5%
F 32430	831900465400	OFWFL K4654K	R 60509 △	870556110500	MOW 0617 22 KOHM 5%
F 34052	814111675000	FILTER 7X7 #750 SIGN11675	R 60516	879005004600	ESTR.SK10-A 4,7 KOHM LIN
IC 34015	830512524800	IC STV2248	R 61018 △	870552111900	MOW 0411 82 KOHM 5%
IC 40550	830534726600	IC TDA7266B	R 62501 △	831120001600	PTC DUO T251-A80-A10
IC 50010	830533817500	IC TDA8174AW	R 62502	831100501700	NTC 4,7 OHM 30%
IC 60510	830533464600	IC TDA16846	R 62549 △	876504916100	MSW SI 0414 4,7 MOHM VDE
IC 61040	830520431700	IC LM317T	SI 40551 △	831561902800	SI LOET T1,6A 250V
IC 61050	830520431700	IC LM317T	SI 62501 △	831561700600	SI 5200 T2,5A L250V
IC 61060	830520570300	IC MC7805CT			
IC 80500	830521006500	IC MC33164P-5RP	T 52001	830328563700	TRANS BC637
IC 80920	297980200200	IC 27C020 PROG.KPL	T 53001	830290002000	TRANS S2055N
WW.	297980200400	IC 27C020 PROG.KPL	T 60506	830280504000	TRANS IRFB6C40
IC 81500	293052192600	PROZESSORPLATTE			
WW.	293052193000	PROZESSORPLATTE	TR 52001	092468680400	TRAFO TREIBER
WW.	830415507100	IC ST92195C9B1-S231			TRANSFORMER DRIVER
WW.	830415507200	IC ST92195C9B1-S232	TR 53010 △	292210315700	TRAFO DIODEN-SPLIT
IC 84501	830546133000	IC TSOP1330			R53033 = 1,5 OHM
L 31043	814052644000	DR ST 0411-GRP 8,2UH 10%	WW. △	292016651101	TRAFO DIODEN-SPLIT
L 32109	814052690600	DR 0309 4,7UH 10% ST			R53033 = 1,5 OHM
L 40512	814050525900	DR A AX-GA 27UH 10%	TR 61000 △	292015219703	TRANSFORMER DIODE SPLIT
L 52251	814051174900	DR AX 0411-GA 10UH 10%			SPERRWANDLERTRAFO
L 52256	814052632000	DR AX 0411-GA 3,3UH 10%			B.O.TYPE CONVERTER
		CHOKE			TRANSFORMER

Es gelten die Vorschriften und Sicherheitshinweise gemäß dem Service Manual "Sicherheit", Mat.-Nummer 720108000000, sowie zusätzlich die eventuell abweichenden, landesspezifischen Vorschriften!



The regulations and safety instructions shall be valid as provided by the "Safety" Service Manual, part number 720108000000, as well as the respective national deviations.

ÄNDERUNGEN VORBEHALTEN / SUBJECT TO ALTERATION

Ersatzteilliste Spare Parts List

1 / 2002

GRUNDIG

TV

CHASSIS-FS-STEREO CUC 2121 MUL/DOLBY CHASSIS TV STEREO CUC 2121 MUL/DOLBY

MATERIAL-NR. / PART NO.: 297040133900

POS. NR. POS. NO.	ABB. FIG.	MATERIAL-NR. PART NUMBER	ANZ. QTY.	BEZEICHNUNG (D)	DESCRIPTION (GB)
		297040133900		CHASSIS-FS-STEREO CUC 2121 MUL/DOLBY KEIN E-TEIL	CHASSIS TV STEREO CUC 2121 MUL/DOLBY NO SPARE PART
0100.000		295043010100		TUNER-GLOBAL (PLL)	TUNER GLOBAL (PLL)
0216.000		297033571100		TASTSCHALTER PROGRAMM+	KEY SWITCH PROGRAMM+
0216.000		297033571100		TASTSCHALTER PROGRAMM-	KEY SWITCH PROGRAMM-
0216.000		297033571100		TASTSCHALTER LAUTSTAERKE+	KEY SWITCH VOLUME+
0216.000		297033571100		TASTSCHALTER LAUTSTAERKE-	KEY SWITCH VOLUME-
0240.000		293033904200		KOPFHUERERBUCHSE 3,5 O.SCHALTER	HEADPHONE SOCKET 3,5 W/O SWITCH
0241.000		293031680503		CINCH-BUCHSE 3-FACH FBAS/NF L,R	CINCH SOCKET 3 FOLD FBAS/AF L,R
0247.000		293031190603		EURO-AV BUCHSENLEISTE 21-POL SW	EURO-AV SOCKET STRIP 21 P BLACK
0312.000		297006430104		ABDECKUNG EURO-AV	COVER EURO AV
0500.000		295041028400		BAUSTEIN STEREO MODUL	STEREO MODULE
0910.000	△	292107030101		FOKUSLEITUNG	FOCUSING CABLE
1000.000	△	096211130206	2	SICHERUNGSHALTER SI62501	FUSE HOLDER SI62501
2000.000	△	297033910600		NETZSCHALTER O.WISCHER	POWER SWITCH W/O WIPER
2200.000	△	293033995100		NETZ EINBAUGERAETESTECKER	APPLIANCE COUPLER W.CABLE
2400.000		293031530107		MONTAGECLIP IC40550	MOUNTING CLIP IC40550
2410.000		293031530208	2	MONTAGECLIP IC50010/T53001	MOUNTING CLIP IC50010/T53001
2420.000		293031531600		MONTAGECLIP T60506	MOUNTING CLIP T60506
2430.000		293031531605	3	MONTAGECLIP IC61040/61050/61060	MOUNTING CLIP IC61040/61050/61060
2450.000		293031562000	4	FOLIE WAERMELEITEND	FOIL HEAT CONDUCTING
				IC61040/61050/61060/T60506	IC61040/61050/61060/T60506

 WW = WAHLWEISE
X = SIEHE GESONDERTE E-LISTE

 WW = OPTIONAL
X = SEE SEPARATE PARTS LIST

POS. NR. POS. NO.	MATERIAL-NR. PART NUMBER	BEZEICHNUNG DESCRIPTION	POS. NR. POS. NO.	MATERIAL-NR. PART NUMBER	BEZEICHNUNG DESCRIPTION
C 34026	845296706400	ELKO 1000UF +50-20% 10V	CD 32411	830940159200	SMD DIODE BA591/BA592/BA782S
C 40557	845299610700	ELKO 2200UF 20% 16V	CD 32460	830940159200	SMD DIODE BA591/BA592/BA782S
C 50047	845299618700	ELKO 1000UF 20% 35V	CD 32470	830940159200	SMD DIODE BA591/BA592/BA782S
C 50048	845299864700	ELKO 1000UF 20% 25V	CD 34041	830940159200	SMD DIODE BA591/BA592/BA782S
C 53002	851591111400	FOKO KF #35 9000PF 3,5% 1500V	CD 80501	830940159200	SMD DIODE BA591/BA592/BA782S
C 54011	865006704600	KERKO HV C 100PF 20% 1KV			
C 54012	845299618700	ELKO 1000UF 20% 35V	CIC 80910	830581409400	SMD IC MC14094BD
C 60501	865008112500	KERKO HV C 1000PF 20% 1KV	CIC 80930	830595012900	SMD IC ST92R195C9Q1
C 60509	851591104500	FOKO FKP1 680PF 10% 1600V	CIC 82501	830596000800	SMD IC M24C08CM1TR
C 60512	865008111100	KERKO HV C 270PF 20% 2KV			
C 60523	865008112500	KERKO HV C 1000PF 20% 1KV	CL 40511	810498233100	SMD DAEMPF-PERLE 0805
C 60524	865008112500	KERKO HV C 1000PF 20% 1KV			
C 60526	865008112500	KERKO HV C 1000PF 20% 1KV	CT 32111	830100484800	SMD TRANS BC848B/ BC847B
C 60527	865008112500	KERKO HV C 1000PF 20% 1KV	CT 32122	830100385800	SMD TRANS BC858B/ BC857B
C 60528	845209711500	ELKO SNT #40 150UF 385V/400V	CT 32123	830100484800	SMD TRANS BC848B/ BC847B
WW.	845199711500	ELKO 19 150UF 385V	CT 32124	830100385800	SMD TRANS BC858B/ BC857B
C 61016	851591104000	FOKO FKP1 220PF 10% 1600V	CT 32132	830100484800	SMD TRANS BC848B/ BC847B
C 61036	865006704600	KERKO HV C 100PF 20% 1KV	CT 32460	830100484800	SMD TRANS BC848B/ BC847B
C 61056	865006704600	KERKO HV C 100PF 20% 1KV	CT 32470	830100484800	SMD TRANS BC848B/ BC847B
C 62501	851179301800	FOKO MP3 0,1UF 20% 275VW	CT 32480	830100484800	SMD TRANS BC848B/ BC847B
C 62521	866009623800	KERKO SI 2200PF 20%	CT 34031	830100385800	SMD TRANS BC858B/ BC857B
C 62522	866009623800	KERKO SI 2200PF 20%	CT 40581	830100385800	SMD TRANS BC858B/ BC857B
C 62549	866009623400	KERKO SI 1000PF 20%	CT 43010	830100385800	SMD TRANS BC858B/ BC857B
C 81063	814054010400	EMIFIL 0,1 UF	CT 43015	830100484800	SMD TRANS BC848B/ BC847B

ÄNDERUNGEN VORBEHALTEN / SUBJECT TO ALTERATION

POS. NR. POS. NO.	MATERIAL-NR. PART NUMBER	BEZEICHNUNG DESCRIPTION	POS. NR. POS. NO.	MATERIAL-NR. PART NUMBER	BEZEICHNUNG DESCRIPTION
CT 50005	830100484800	SMD TRANS BC848B/ BC847B	L 52256	814052632000	DR AX 0411-GA 3,3UH 10%
CT 50015	830100484800	SMD TRANS BC848B/ BC847B	L 53003	810498205600	FERRITPERLE HF70 BTL 3,5X6
CT 50040	830100484800	SMD TRANS BC848B/ BC847B			FERRITE BEAD
CT 50050	830100484800	SMD TRANS BC848B/ BC847B	L 53011	814050524900	DR A AX-GA 10UH 10%
CT 50055	830100484800	SMD TRANS BC848B/ BC847B	L 53021	292031149500	LINEARITAETSREGLER
CT 52260	830100385800	SMD TRANS BC858B/ BC857B			LINEARITY CONTROL
CT 57020	830100385800	SMD TRANS BC858B/ BC857B	L 53074	092468700101	ZB-SPULE/ZB COIL
CT 57021	830100385800	SMD TRANS BC858B/ BC857B	L 60506	810498205700	FERRITPERLE 3,6UH
CT 57112	830100385800	SMD TRANS BC858B/ BC857B	L 61038	810498200300	FERRITPERLE BL02RN2-R62
CT 57113	830100385800	SMD TRANS BC858B/ BC857B			FERRITE BEAD
CT 57124	830100484800	SMD TRANS BC848B/ BC847B	L 62501	295008269700	FUNKENTSTOERDROSSEL RK19
CT 61043	830100484800	SMD TRANS BC848B/ BC847B			INTERFERENCE SUPPR. CHOKE
CT 61053	830100484800	SMD TRANS BC848B/ BC847B	L 81061	810498205100	FERRITPERLE HF55 BTL 3,5X4,5
CT 81220	830100484800	SMD TRANS BC848B/ BC847B			FERRITE BEAD
CT 81225	830100484800	SMD TRANS BC848B/ BC847B	L 81062	814052636100	DR 0411 10UH 5%
CT 85502	830100385800	SMD TRANS BC858B/ BC857B	L 81064	814052636100	DR 0411 10UH 5%
D 40584	830921504500	DIODE 1N4148	Q 34043	838212104400	QUARZ 4,433619 MHZ
D 40586	830921504500	DIODE 1N4148	Q 34044	838204900300	QUARZ 3,579545MHZ
D 43055	830921504500	DIODE 1N4148	Q 80001	838208004000	QUARZ 4 MHZ
D 43056	830921504500	DIODE 1N4148	Q 80951	838216204100	QUARZ 4 MHZ
D 50023	830921502000	DIODE 1N4004			
D 50048	830970301400	Z-DIODE 2PZY5,6 2%	R 40551	873229240700	DRW 4 1,8 OHM 10%
D 52001	830921504500	DIODE 1N4148	R 43006	870001124600	KSW 0204 75 OHM 5%
D 53003	830920100500	DIODE BA157	R 50047	876642460200	MSW 0207 1,1 OHM 1% ST
D 54001	830920426800	DIODE BYV16	R 50048	870552103300	MOW 0411 22 OHM 5% LI
D 54011	830920100500	DIODE BA157	R 50050	870522705300	MOW 0411 150 OHM 5%
D 54022	830972033000	Z-DIODE 30 B 0,5W	R 52004	870552105300	MOW 0411 150 OHM 5% LI
D 57013	830921504500	DIODE 1N4148	R 53002	870042909700	KSW NB 0207 10 KOHM 5% ST
D 57023	830921504500	DIODE 1N4148	R 53009	871033814500	MGW AX 1 MOHM 5%
D 60506	830951685400	DIODE BYT 54 M	R 53011	870552102100	MOW 0411 6,8 OHM 5% LI
D 60509	830966318000	Z-DIODE BZT03D180	R 53016	873018942500	DRW 9 10 OHM 10%
D 60512	830951675400	DIODE BYT53B	R 53021	870522707100	MOW 0411 820 OHM 5%
D 60523	830856038400	GLR.SKB380C1500	R 53033	870552098500	MOW 0411 0,22 OHM 5% LI
D 61016	830951717800	DIODE BYW178	R 53074	870556107100	MOW 0617 820 OHM 5% LI
D 61037	830951710800	DIODE BYT108-400	R 54001	870552102500	MOW 0411 10 OHM 5% LI
D 61056	830951717200	DIODE BYW172D	R 54006	870552100900	MOW 0411 2,2 OHM 5% LI
D 85511	830994460100	LE DIODE TLHR 4601	R 54022	870556111100	MOW 0617 39 KOHM 5% LI
F 32109	860275506600	KERTRAP #66 5,5/6/6,5MHZ	R 60502	870006935600	KSW 0617 3 MOHM 2%
F 32121	814111360000	FILTER 7X7 360	R 60504	870006934700	KSW 0617 1,2 MOHM 2%
F 32410	814053445100	SPULE 7X7 #451	R 60508	870556110500	MOW 0617 22 KOHM 5% LI
F 32412	831900395300	OFWFIL K3953M	R 60509	870556110500	MOW 0617 22 KOHM 5% LI
F 32430	831900465400	OFWFIL K4654K	R 60516	879005004600	ESTR.SK10-A 4,7 KOHM LIN
F 34052	814111675000	FILTER 7X7 #750	R 61018	870552111900	MOW 0411 82 KOHM 5% LI
IC 34015	830512524800	IC STV2248	R 62501	831120001800	PTC DUO B59709-T60-A110
IC 40550	830534726600	IC TDA7266B	R 62502	831100501700	NTC 4,7 OHM 30%
IC 50010	830533817500	IC TDA8174AW	R 62549	876504916100	MSW SI 0414 4,7 MOHM VDE
IC 60510	830533464600	IC TDA16846	SI 40551	831561902800	SI LOET T1,6A 250V
IC 61040	830520431700	IC LM317T	SI 62501	831561700600	SI 5X20 T2,5A L 250V
IC 61050	830520431700	IC LM317T	T 52001	830328563700	TRANS.BC 637
IC 61060	830520570300	IC MC7805CT	T 53001	830290002000	TRANS S2055N/ BU508DF
IC 80500	830521006500	IC MC33164P-5RP	T 60506	830280504000	TRANS.IRF BC 40 IOR ZNG.2
IC 81500	293052193000	PROZESSORPLATTE 7-SEITEN TEXT			
IC 81500	830415507200	IC ST92195C9B1-S232 7-SEITEN TEXT	TR 52001	092468680400	TRAFO TREIBER
IC 80920	297980200400	IC 27C020 PROG.KPL 7-SEITEN TEXT			DRIVER TRANSFORMER
IC 81500	293052192600	PROZESSORPLATTE 8-SEITEN TEXT	TR 53010	292210315700	TRAFO DIODEN-SPLIT KPL
WW.	830415507100	IC ST92195C9B1-S231 8-SEITEN TEXT			DIODE SPLIT TRANSFORMER CPL
IC 80920	297980200200	IC 27C020 PROG.KPL 8-SEITEN TEXT	TR 53020	292016651101	DIODEN-SPLIT TRAFO
IC 84501	830546133000	IC TSOP1330			DIODE SPLIT TRANSFORMER
L 31043	814052644000	DR ST 0411-GRP 8,2UH 10%	TR 61000	292015219703	SPERRWANDLERTRAFO
L 32109	814052690600	DR 0309 4,7UH 10% ST			REVERSE CONVERTER
L 40512	814050525900	DR A AX-GA 27UH 10%			TRANSFORMER
L 52251	814051174900	DR AX 0411-GA 10UH 10%			

Es gelten die Vorschriften und Sicherheitshinweise gemäß dem Service Manual "Sicherheit", Mat.-Nummer 720108000000, sowie zusätzlich die eventuell abweichenden, landesspezifischen Vorschriften!



The regulations and safety instructions shall be valid as provided by the "Safety" Service Manual, part number 720108000000, as well as the respective national deviations.

ÄNDERUNGEN VORBEHALTEN / SUBJECT TO ALTERATION

Ersatzteilliste
Spare Parts List

1 / 2002

CHASSIS-FS-STEREO CUC 2121 MUL/DOLBY
CHASSIS TV STEREO CUC 2121 MUL/DOLBY

MATERIAL-NR. / PART NO.: 297040134600

POS. NR. POS. NO.	ABB. FIG.	MATERIAL-NR. PART NUMBER	ANZ. QTY.	BEZEICHNUNG (D)	DESCRIPTION (GB)
		297040134600		CHASSIS-FS-STEREO CUC 2121 MUL/DOLBY KEIN E-TEIL	CHASSIS TV STEREO CUC 2121 MUL/DOLBY NO SPARE PART
0100.000		295043010100		TUNER-GLOBAL (PLL)	TUNER GLOBAL (PLL)
0216.000		297033571100		TASTSCHALTER PROGRAMM+	KEY SWITCH PROGRAMME+
0216.000		297033571100		TASTSCHALTER PROGRAMM-	KEY SWITCH PROGRAMME-
0216.000		297033571100		TASTSCHALTER LAUTSTAERKE+	KEY SWITCH VOLUME+
0216.000		297033571100		TASTSCHALTER LAUTSTAERKE-	KEY SWITCH VOLUME-
0240.000		293033904200		KOPFHOERERBUCHSE 3,5 O.SCHALTER	HEADPHONE SOCKET 3,5 W/O SWITCH
0241.000		293031680503		CINCH-BUCHSE 3-FACH FBAS/NF L,R	CINCH SOCKET 3 FOLD FBAS/AF L,R
0247.000		293031196603		EURO-AV BUCHSENLEISTE 21-POL SW	EURO-AV SOCKET STRIP 21 P BLACK
0312.000		297006430104		ABDECKUNG EURO-AV	COVER EURO AV
0500.000		295041028400	X	BAUSTEIN STEREO MODUL	STEREO MODULE
0910.000	△	292107030101		FOKUSLEITUNG	FOCUSING CABLE
1000.000	△	096211130206	2	SICHERUNGSHALTER SI62501	FUSE HOLDER SI62501
2000.000	△	297033910600		NETZSCHALTER O.WISCHER	POWER SWITCH W/O WIPER
2200.000	△	293033995100		NETZ EINBAUGERAETESTECKER	APPLIANCE COUPLER W.CABLE
2400.000		293031530107		MONTAGECLIP IC40550	MOUNTING CLIP IC40550
2410.000		293031530208	2	MONTAGECLIP IC50010/T53001	MOUNTING CLIP IC50010/T53001
2420.000		293031531600		MONTAGECLIP T60506	MOUNTING CLIP T60506
2430.000		293031531605	3	MONTAGECLIP IC61040/61050/61060	MOUNTING CLIP IC61040/61050/61060
2450.000		293031562000	4	FOIL WAEARMELEITEND	FOIL HEAT CONDUCTING
				IC61040/61050/61060/T60506	IC61040/61050/61060/T60506
				WW.=WAHLWEISE X=SIEHE GESONDERTE E-LISTE	WW.=OPTIONAL X=SEE SEPARATE PARTS LIST

POS. NR. POS. NO.	MATERIAL-NR. PART NUMBER	BEZEICHNUNG DESCRIPTION	POS. NR. POS. NO.	MATERIAL-NR. PART NUMBER	BEZEICHNUNG DESCRIPTION
C 34026	845296706400	ELKO 1000UF +50-20% 10V	C 81063	814054010400	EMIFIL 0,1 UF
C 40557	845299610700	ELKO 2200UF 20% 16V	CD 32411	830940159200	SMD DIODE BA591/BA592/BA782S
C 50047	845299618700	ELKO 1000UF 20% 35V	CD 32460	830940159200	SMD DIODE BA591/BA592/BA782S
C 50048	845299864700	ELKO 1000UF 20% 25V	CD 32470	830940159200	SMD DIODE BA591/BA592/BA782S
C 53002	851591110200	FOKO FKP1/4 8500PF 3,5% 1500V	CD 34041	830940159200	SMD DIODE BA591/BA592/BA782S
C 54011	865006704600	KERKO HV C 100PF 20% 1KV	CD 80501	830940159200	SMD DIODE BA591/BA592/BA782S
C 54012	845299618700	ELKO 1000UF 20% 35V			
C 60501	865008112500	KERKO HV C 1000PF 20% 1KV	CIC 80910	830581409400	SMD IC MC14094BD
C 60509	851591104500	FOKO FKP1 680PF 10% 1600V	CIC 80930	830595012900	SMD IC ST92R195C9Q1
C 60512	865008111100	KERKO HV C 270PF 20% 2KV	CIC 82501	830596000800	SMD IC M24C08CM1TR
C 60523	865008112500	KERKO HV C 1000PF 20% 1KV			
C 60524	865008112500	KERKO HV C 1000PF 20% 1KV			
C 60526	865008112500	KERKO HV C 1000PF 20% 1KV	CL 40511	810498233100	SMD DAEMPF-PERLE 0805
C 60527	865008112500	KERKO HV C 1000PF 20% 1KV			
C 60528	845209711500	ELKO SNT #40 150UF 385V/400V	CT 32111	830100484800	SMD TRANS BC848B/ BC847B
WW.	845199711500	ELKO 19 150UF 385V	CT 32122	830100385800	SMD TRANS BC858B/ BC857B
C 61016	851591104000	FOKO FKP1 220PF 10% 1600V	CT 32123	830100484800	SMD TRANS BC848B/ BC847B
C 61036	865006704600	KERKO HV C 100PF 20% 1KV	CT 32124	830100385800	SMD TRANS BC858B/ BC857B
C 61056	865006704600	KERKO HV C 100PF 20% 1KV	CT 32132	830100484800	SMD TRANS BC848B/ BC847B
C 62501	851179301800	FOKO MP3 0,1UF 20% 275VW	CT 32460	830100484800	SMD TRANS BC848B/ BC847B
C 62521	866009623800	KERKO SI 2200PF 20%	CT 32470	830100484800	SMD TRANS BC848B/ BC847B
C 62522	866009623800	KERKO SI 2200PF 20%	CT 32480	830100484800	SMD TRANS BC848B/ BC847B
C 62549	866009623400	KERKO SI 1000PF 20%	CT 34031	830100385800	SMD TRANS BC858B/ BC857B

ÄNDERUNGEN VORBEHALTEN / SUBJECT TO ALTERATION

GRUNDIG

TV

POS. NR. MATERIAL-NR. BEZEICHNUNG
POS. NO. PART NUMBER DESCRIPTION

CT 40581	830100385800	SMD TRANS BC858B/ BC857B
CT 43010	830100385800	SMD TRANS BC858B/ BC857B
CT 43015	830100484800	SMD TRANS BC848B/ BC847B
CT 50005	830100484800	SMD TRANS BC848B/ BC847B
CT 50015	830100484800	SMD TRANS BC848B/ BC847B
CT 50040	830100484800	SMD TRANS BC848B/ BC847B
CT 50050	830100484800	SMD TRANS BC848B/ BC847B
CT 50055	830100484800	SMD TRANS BC848B/ BC847B
CT 52260	830100385800	SMD TRANS BC858B/ BC857B
CT 57020	830100385800	SMD TRANS BC858B/ BC857B
CT 57021	830100385800	SMD TRANS BC858B/ BC857B
CT 57112	830100385800	SMD TRANS BC858B/ BC857B
CT 57113	830100385800	SMD TRANS BC858B/ BC857B
CT 57124	830100484800	SMD TRANS BC848B/ BC847B
CT 61043	830100484800	SMD TRANS BC848B/ BC847B
CT 61053	830100484800	SMD TRANS BC848B/ BC847B
CT 81220	830100484800	SMD TRANS BC848B/ BC847B
CT 81225	830100484800	SMD TRANS BC848B/ BC847B
CT 85502	830100385800	SMD TRANS BC858B/ BC857B

D 40584	830921504500	DIODE 1N4148
D 40586	830921504500	DIODE 1N4148
D 43055	830921504500	DIODE 1N4148
D 43056	830921504500	DIODE 1N4148
D 50023	830921502000	DIODE 1N4004
D 50048	830970301400	Z-DIODE ZPZY5.6 2%
D 52001	830921504500	DIODE 1N4148
D 53003	830920100500	DIODE BA157
D 54001	830920426800	DIODE BYV16
D 54011	830920100500	DIODE BA157
D 54022	830972033000	Z-DIODE 30 B 0,5W
D 57013	830921504500	DIODE 1N4148
D 57023	830921504500	DIODE 1N4148
D 60506	830951685400	DIODE BYT 54 M
D 60509	830966318000	Z-DIODE BZT03D180
D 60512	830951675400	DIODE EYT753B
D 60523	830850630800	GLR.SKB380C1500
D 61016	830951717800	DIODE BYW178
D 61037	830951710800	DIODE BYT108-2D
D 61056	830951717200	DIODE BYW172D
D 85511	830994460100	LE DIODE TLHR 4601

F 32109	860275506600	KERTRAP #66 5,5/6/6,5MHZ
F 32121	814111136000	FILTER 7X7 360
F 32410	814053445100	SPULE 7X7 #451
F 32412	831900395300	OFWFIL K3953M
F 32430	831900465400	OFWFIL K4654K
F 34052	814111675000	FILTER 7X7 #750

IC 34015	830512524800	IC STV2248
IC 40550	830534726600	IC TDA7266B
IC 50010	830533817500	IC TDA8174AW
IC 60510	830533464000	IC TDA16846
IC 61040	830520431700	IC LM317T
IC 61050	830520431700	IC LM317T
IC 61060	830520570300	IC MC7805CT
IC 80500	830521006500	IC MC33164P-5RP
IC 81500	293052193000	PROZESSORPLATTE 7-SEITEN TEXT
WW.	830415507200	IC ST92195C9B1-S232 7-SEITEN TEXT
IC 80920	297980200400	IC 27C020 PROG.KPL 7-SEITEN TEXT
IC 81500	293052192600	PROZESSORPLATTE 8-SEITEN TEXT
WW.	830415507100	IC ST92195C9B1-S231 8-SEITEN TEXT
IC 80920	297980200200	IC 27C020 PROG.KPL 8-SEITEN TEXT
IC 84501	830546133000	IC TSOP1330

L 31043	814052644000	DR ST 0411-GRP 8,2UH 10%
---------	--------------	--------------------------

Es gelten die Vorschriften und Sicherheitshinweise gemäß dem Service Manual "Sicherheit", Mat.-Nummer 720108000000, sowie zusätzlich die eventuell abweichenden, landesspezifischen Vorschriften!



The regulations and safety instructions shall be valid as provided by the "Safety" Service Manual, part number 720108000000, as well as the respective national deviations.

ÄNDERUNGEN VORBEHALTEN / SUBJECT TO ALTERATION

Ersatzteilliste Spare Parts List

6 / 2001

CHASSIS-FS-STEREO CUC 2121 MULTI/DOLBY CHASSIS TV STEREO CUC 2121 MULTI/DOLBY

MATERIAL-NR. / PART NO.: 297040135000

POS. NR. POS. NO.	ABB. FIG.	MATERIAL-NR. PART NUMBER	ANZ. QTY.	BEZEICHNUNG (D)	DESCRIPTION (GB)
		297040135000		CHASSIS-FS-STEREO CUC 2121 MULTI/DOLBY KEIN E-TEIL	CHASSIS TV STEREO CUC 2121 MULTI/DOLBY NO SPARE PART
0100.000		295043010100		TUNER-GLOBAL (PLL)	TUNER-GLOBAL (PLL)
0206.000		297006430104		ABDECKUNG EURO AV	COVER EURO AV
0216.000		297033571100		TASTSCHALTER PROGRAMM +	KEY SWITCH PROGRAMME +
0216.000		297033571100		TASTSCHALTER PROGRAMM -	KEY SWITCH PROGRAMME -
0216.000		297033571100		TASTSCHALTER LAUTSTAERKE +	KEY SWITCH VOLUME +
0216.000		297033571100		TASTSCHALTER LAUTSTAERKE -	KEY SWITCH VOLUME -
0240.000		293033904200		KOPFHÖRERBUCHSE 3,5MM O.SCHALTER	HEADPHONE SOCKET 3,5MM W/O SWITCH
0241.000		293031680503		CINCH-BUCHSE 3-FACH FBAS/NF L,R	CINCH SOCKET 3 FOLD FBAS/AC L,R
0247.000		293031190603		EURO-AV BUCHSENLEISTE 21-POL SW	EURO-AV SOCKET STRIP 21 PIN BLACK
0500.000		295041028400	X	BAUSTEIN STEREO MODUL	STEREO MODULE
0910.000	Δ	292107030101		FOKUSLEITUNG	FOCUSING CABLE
1000.000	Δ	096211130206	2	SICHERUNGSHALTER SI62501	FUSE HOLDER SI62501
1360.000	Δ	297033910600		NETZSCHALTER O.WISCHER	POWER SWITCH W/O WIPER
2200.000	Δ	293033995100		NETZ EINBAUGERÄTESTECKER	APPLIANCE COUPLER
2400.000		293031530107		MONTAGECLIP IC40550	MOUNTING CLIP IC40550
2410.000		293031530208	2	MONTAGECLIP IC50010/T53001	MOUNTING CLIP IC50010/T53001
2420.000		293031531600		MONTAGECLIP T60506	MOUNTING CLIP T60506
2430.000		293031531605	3	MONTAGECLIP IC61040/61050/61060	MOUNTING CLIP IC61040/61050/61060
2450.000		293031562000	4	FOLIE WÄRMELEITEND IC61040/61050/61060/T60506	FOIL HEAT CONDUCTING IC61040/61050/61060/T60506

 X = SIEHE GESONDERTE E-LISTE
WW. = WAHLWEISE

 X = SEE SEPARATE PARTS LIST
WW. = OPTIONAL

POS. NR. POS. NO.	MATERIAL-NR. PART NUMBER	BEZEICHNUNG DESCRIPTION	POS. NR. POS. NO.	MATERIAL-NR. PART NUMBER	BEZEICHNUNG DESCRIPTION
C 34026	845296706400	ELKO 1000UF +50-20% 10V	CIC82501	830596000800	SMD IC M24C08CM1TR
C 40557	845299610700	ELKO 2200UF 20% 16V			
C 50047	845299618700	ELKO 1000UF 20% 35V	CL 40511	810498233100	SMD DAEMPF-PERLE 0805 BLM SMD DAMPING BEAD
C 50048	845299864700	ELKO 1000UF 20% 25V			
C 53002	851591111400	FOKO KF #35 9000PF 3,5% 1500V			
C 54011	865006704600	KERKO HV C 100PF 20% 1KV	CT 32111	830100484800	SMD TRANS BC848B/BC847B
C 54012	845299618700	ELKO 1000UF 20% 35V	CT 32122	830100385800	SMD TRANS BC858B/BC857B
C 60501	865008112500	KERKO HV C 1000PF 20% 1KV	CT 32123	830100484800	SMD TRANS BC848B/BC847B
C 60509	851591104500	FOKO FKP1 680PF 10% 1600V	CT 32124	830100385800	SMD TRANS BC858B/BC847B
C 60512	865008111100	KERKO HV C 270PF 20% 2KV	CT 32125	830100484800	SMD TRANS BC848B/BC847B
C 60523	865008112500	KERKO HV C 1000PF 20% 1KV	CT 32460	830100484800	SMD TRANS BC848B/BC847B
C 60524	865008112500	KERKO HV C 1000PF 20% 1KV	CT 32470	830100484800	SMD TRANS BC848B/BC847B
C 60526	865008112500	KERKO HV C 1000PF 20% 1KV	CT 32480	830100484800	SMD TRANS BC848B/BC847B
C 60527	865008112500	KERKO HV C 1000PF 20% 1KV	CT 34031	830100385800	SMD TRANS BC858B/BC857B
C 61016	851591104000	FOKO FKP1 220PF 10% 1600V	CT 40581	830100385800	SMD TRANS BC858B/BC857B
C 61036	865006704600	KERKO HV C 100PF 20% 1KV	CT 43010	830100385800	SMD TRANS BC858B/BC857B
C 61056	865006704600	KERKO HV C 100PF 20% 1KV	CT 43015	830100484800	SMD TRANS BC848B/BC847B
C 62501	851179301800	MP3 0,1UF 20% 250V	CT 50005	830100484800	SMD TRANS BC848B/BC847B
C 62521	866009623800	KERKO SI 2200PF 20% 400V	CT 50015	830100484800	SMD TRANS BC848B/BC847B
C 62522	866009623800	KERKO SI 2200PF 20% 400V	CT 50040	830100484800	SMD TRANS BC848B/BC847B
C 62548	866009623400	KERKO SI 1000PF 20% 400V	CT 50050	830100484800	SMD TRANS BC848B/BC847B
C 81063	814054010400	EMFIL 0,1 UF -GR	CT 50055	830100484800	SMD TRANS BC848B/BC847B
CIC80910	830581409400	SMD IC MC14094BD	CT 52260	830100385800	SMD TRANS BC858B/BC857B
CIC80930	830595012900	SMD IC ST92R195C9Q1	CT 57020	830100385800	SMD TRANS BC858B/BC857B
			CT 57021	830100385800	SMD TRANS BC858B/BC857B

ÄNDERUNGEN VORBEHALTEN / SUBJECT TO ALTERATION

GRUNDIG

TV

POS. NR. POS. NO.	MATERIAL-NR. PART NUMBER	BEZEICHNUNG DESCRIPTION
CT 57112	830100385800	SMD TRANS BC858B/BC857B
CT 57113	830100385800	SMD TRANS BC858B/BC857B
CT 57124	830100484800	SMD TRANS BC848B/BC847B
CT 61043	830100484800	SMD TRANS BC848B/BC847B
CT 61053	830100484800	SMD TRANS BC848B/BC847B
CT 81220	830100484800	SMD TRANS BC848B/BC847B
CT 81225	830100484800	SMD TRANS BC848B/BC847B
CT 85502	830100385800	SMD TRANS BC858B/BC857B
D 40584	830921504500	DIODE 1N4148
D 40586	830921504500	DIODE 1N4148
D 43055	830921504500	DIODE 1N4148
D 43056	830921504500	DIODE 1N4148
D 50023	830921502000	DIODE 1N4004
D 50048	830970301400	Z-DIODE ZPY5,6 2%
D 52001	830921504500	DIODE 1N4148
D 53003	830920100500	DIODE BA157
D 54001	830920426800	DIODE BYV16
D 54011	830920100500	DIODE BA157
D 54022	830972033000	Z-DIODE 30B 0,5W
D 57013	830921504500	DIODE 1N4148
D 57023	830921504500	DIODE 1N4148
D 60506	830951685400	DIODE BYT54M
D 60509	830966318000	Z-DIODE BZT03D180
D 60512	830951675400	DIODE BYT53B
D 60523	830856038400	GLR.SKB380C1500
D 61016	830951717800	DIODE BYW178
D 61036	830951710800	DIODE BYT108-400
D 61056	830951717200	DIODE BYW172D
D 85001	830994460100	LE DIODE TLHR4601
F 32109	860275506600	KERTRAP #66 5,5/6,6,5MHZ
F 32121	814111136000	FILTER 7X7 360
F 32410	814053445100	SPLULE 7X7 #451
F 32412	831900395300	OFWFIL K3953M
F 32430	831900465400	OFWFIL K4654K
F 34250	814111675000	FILTER 7X7 #750
IC 34015	830512524800	IC STV2248
IC 40550	830534726600	IC TDA7266B
IC 50010	830533817500	IC TDA817AAW
IC 60510	830533464600	IC TDA16846
IC 61040	830520431700	IC LM317T
IC 61050	830520431700	IC LM317T
IC 61060	830520570300	IC MC7805CT
IC 80500	830521006500	IC MC33164P-5RP
IC 81500	293052193000	PROZESSORPLATTE 7-S. TEXT
WW.	830415507200	IC ST92195C9B1-S232 7-S. TEXT
IC 80920	297980200400	IC 27C020 PROG.KPL 7-S. TEXT
IC 81500	293052192600	PROZESSORPLATTE 8-S. TEXT
WW.	830415507100	IC ST92195C9B1-S231 8-S. TEXT
IC 80920	297980200200	IC 27C020 PROG.KPL 8-S. TEXT
IC 84501	830546133000	IC TSOP1330
L 31043	814052644000	DR ST 0411-GRP 8,2UH 10%
L 32109	814052690600	DR 0309 4,7UH 10%
L 40512	814050525900	DR AX-GA 27UH 10%
L 52251	814051174900	DR AX 0411-GA 1,0UH 10%
L 52256	814052632000	DR AX 0411-GA 3,3UH 10% CHOKE
L 53003	810498205600	FERRITPERLE HF70 BTL 3,5X6 FERRITE BEAD
L 53011	814050524900	DR AX-GA 10UH 10% CHOKE
L 53021	292031149500	LINEARITAETSREGLER LINEARITY CONTROL
L 53074	092468700101	ZB-SPLULE/ZB COIL

Es gelten die Vorschriften und Sicherheitshinweise gemäß dem Service Manual "Sicherheit", Mat.-Nummer 720108000000, sowie zusätzlich die eventuell abweichenden, landesspezifischen Vorschriften!



POS. NR. POS. NO.	MATERIAL-NR. PART NUMBER	BEZEICHNUNG DESCRIPTION
L 60506	810498205700	FERRITPERLE 3,6UH 5720500
L 61038	810498200300	FERRITPERLE BL02RN2-R62 FERRITE BEAD
L 62501	295008269700	FUNKTENTSTOERDROSSEL INTERFERENCE CHOKE
L 81061	810498205100	FERRITPERLE HF55 BTL 3,5X4,5 FERRITE BEAD
L 81062	814052636100	DR 0411 10UH 5%
L 81064	814052636100	DR 0411 10UH 5%
Q 34043	838212104400	QUARZ 4,433619 MHZ
Q 34044	838204900300	QUARZ 3,579545MHZ
Q 80001	838208004000	QUARZ 4 MHZ
Q 80951	838216204100	QUARZ 4 MHZ
R 40551	873229240700	DRW 4 1,8 OHM 10%
R 50047	876642460100	MSW 0207 1 OHM 1%
R 50048	870552103300	MOW 0411 22 OHM 5%
R 50050	870522705300	MOW 0411 150 OHM 5%
R 52004	870552105300	MOW 0411 150 OHM 5%
R 53009	871033814500	MGW AX 1 MOHM 5%
R 53011	870552102100	MOW 0411 1,6 OHM 5%
R 53016	873018942500	DRW 9 10 OHM 10%
R 53021	870522707100	MOW 0411 820 OHM 5%
R 53033	870552098500	MOW 0411 0,22 OHM 5%
R 53033	870552100300	MOW 0411 1,2 OHM 5%
R 53074	870556107100	MOW 0617 820 OHM 5%
R 54001	870552102500	MOW 0411 10 OHM 5%
R 54006	870552100900	MOW 0411 2,2 OHM 5%
R 54022	870556111100	MOW 0617 39 KOHM 5%
R 60502	870006935600	KSW 0617 3 MOHM 2%
R 60504	870006934700	KSW 0617 1,2 MOHM 2%
R 60508	870556110500	MOW 0617 22 KOHM 5%
R 60509	870556110500	MOW 0617 22 KOHM 5%
R 60516	879005004600	ESTR.SK10-A-4,7 KOHM LIN
R 61018	870552111900	MOW 0411 82 KOHM 5%
R 62501	831120001800	PTC DUO B59709-T60-A110
R 62502	831100501700	NTC 4,7 OHM 30%
R 62549	876504916100	MSW SI 0414 4,7 MOHM VDE
SI 40551	831561902800	SI LQET T1,6A 250V
SI 62501	831561700600	SI 5X20 T2,5A L 250V
T 52001	830328563700	TRANS BC637
T 53001	830290002000	TRANS S2055N
T 60506	830280504000	TRANS IRFBC40
TR 52001	092468680400	TRAFO TREIBER TRANSFORMER DRIVER
TR 53010	292210315700	TRAFO DIODEN-SPLIT BEI R 53033 = 0,22 OHM TRANSFORMER DIODE SPLIT FOR R 53033 = 0,22 OHM
TR 53020	292016651101	TRAFO DIODEN-SPLIT BEI R 53033 = 1,2 OHM TRANSFORMER DIODE SPLIT FOR R 53033 = 1,2 OHM
TR 61000	292015219700	SPERRWÄNDLERTRAFO B.O.TYPE CONVERTER TRANSFORMER

The regulations and safety instructions shall be valid as provided by the "Safety" Service Manual, part number 720108000000, as well as the respective national deviations.

ÄNDERUNGEN VORBEHALTEN / SUBJECT TO ALTERATION

Ersatzteilliste
Spare Parts List**3 / 2002****CHASSIS-FS-STEREO CUC 2121 GB DOLBY
CHASSIS TV STEREO CUC 2121 GB DOLBY**

MATERIAL-NR. / PART NO.: 297040135200

POS. NR. POS. NO.	ABB. FIG.	MATERIAL-NR. PART NUMBER	ANZ. QTY.	BEZEICHNUNG (D)	DESCRIPTION (GB)
		297040135200		CHASSIS-FS-STEREO CUC 2121 GB DOLBY KEIN E-TEIL	CHASSIS TV STEREO CUC 2121 GB DOLBY NO SPARE PART
0100.000		295043010100		TUNER-GLOBAL (PLL)	TUNER GLOBAL (PLL)
0215.000		297033571100		TASTSCHALTER PROGRAMM +	KEY SWITCH PROGRAMME +
0215.000		297033571100		TASTSCHALTER PROGRAMM -	KEY SWITCH PROGRAMME -
0215.000		297033571100		TASTSCHALTER LAUTSTAERKE +	KEY SWITCH VOLUME +
0215.000		297033571100		TASTSCHALTER LAUTSTAERKE -	KEY SWITCH VOLUME -
0240.000		293033904200		KOPPHOERERBUCHSE 3,5mm O.SCHALTER	HEADPHONE SOCKET 3,5mm W/O SWITCH
0241.000		293031180503		CINCH-BUCHSE 3-FACH FBAS/NF L,R	CINCH SOCKET 3 FOLD FBAS/AF L,R
0247.000		293031190603		EURO-AV BUCHSENLEISTE 21-POL SW	EURO-AV SOCKET STRIP 21 PIN BLACK
0312.000		297006430104		ABDECKUNG EURO-AV	COVER EURO AV
0500.000		295041028400	X	BAUSTEIN STEREO	STEREO MODULE
0910.000	△	292107030100		FOKUSLEITUNG	FOCUSING CABLE
1000.000	△	096211130206	2	SICHERUNGSHALTER SI62501	FUSE HOLDER SI62501
2000.000	△	297033910600		NETZSCHALTER O.WISCHER	POWER SWITCH W/O WIPER
2200.000	△	293033995100		NETZ EINBAUGERAETESTECKER	APPLIANCE COUPLER
2400.000		293031530107		MONTAGECLIP IC40550	MOUNTING CLIP IC40550
2410.000		293031530208	2	MONTAGECLIP T53001/IC50010	MOUNTING CLIP T53001/IC50010
2440.000		293031531600		MONTAGECLIP T60506	MOUNTING CLIP T60506
2445.000		293031531605	3	MONTAGECLIP IC61040/61050/61060	MOUNTING CLIP IC61040/61050/61060
2470.000		293031562000	4	FOLIE WAERMELEITEND T60506/ IC61040/61050/61060	FOIL HEAT CONDUCTING T60506/ IC61040/61050/61060
				X = SIEHE GESONDERTE E-LISTE WW. = WAHLWEISE	X = SEE SEPARATE PARTS LIST WW. = OPTIONAL

POS. NR. POS. NO.	MATERIAL-NR. PART NUMBER	BEZEICHNUNG DESCRIPTION	POS. NR. POS. NO.	MATERIAL-NR. PART NUMBER	BEZEICHNUNG DESCRIPTION
C 34026	845296706400	ELKO 1000UF +50-20% 10V	CIC 80910	830581409400	SMD IC MC14094BD
C 40557	845299610700	ELKO 2200UF 20% 16V	CIC 80930	830595012900	SMD IC ST92R195C9Q1
C 50047	845299618700	ELKO 1000UF 20% 35V	CIC 82501	830596000800	SMD IC M24C08CM1TR
C 50048	845299864700	ELKO 1000UF 20% 25V			
C 53002	851591111400	FOKO KF #35 9000PF 3,5% 1500V	CL 40511	810498233100	SMD DAEMPF-PERLE 0805 BLM
C 54011	865006704600	KERKO HV C 100PF 20% 1KV			SMD DAMPING BEAD
C 54012	845299618700	ELKO 1000UF 20% 35V			
C 60501	865008112500	KERKO HV C 1000PF 20% 1KV	CT 32124	830100385800	SMD TRANS BC858B/BC857B
C 60509	851591104500	FOKO FKP1 680PF 10% 1600V	CT 34031	830100385800	SMD TRANS BC858B/BC857B
C 60512	865008111100	KERKO HV C 270PF 20% 2KV	CT 40581	830100385800	SMD TRANS BC858B/BC857B
C 60523	865008112500	KERKO HV C 1000PF 20% 1KV	CT 43010	830100385800	SMD TRANS BC858B/BC857B
C 60524	865008112500	KERKO HV C 1000PF 20% 1KV	CT 43015	830100484800	SMD TRANS BC848B/BC847B
C 60526	865008112500	KERKO HV C 1000PF 20% 1KV	CT 50005	830100484800	SMD TRANS BC848B/BC847B
C 60527	865008112500	KERKO HV C 1000PF 20% 1KV	CT 50015	830100484800	SMD TRANS BC848B/BC847B
C 61016	851591104000	FOKO FKP1 220PF 10% 1600V	CT 50040	830100484800	SMD TRANS BC848B/BC847B
C 61036	865006704600	KERKO HV C 100PF 20% 1KV	CT 50050	830100484800	SMD TRANS BC848B/BC847B
C 61056	865006704600	KERKO HV C 100PF 20% 1KV	CT 50055	830100484800	SMD TRANS BC848B/BC847B
C 62501 △	851179301800	FOKO MP3 0,1UF 20% 275V	CT 52260	830100385800	SMD TRANS BC858B/BC857B
C 62521 △	866009623800	KERKO SI 2200PF 20% 400V	CT 57020	830100385800	SMD TRANS BC858B/BC857B
C 62522 △	866009623800	KERKO SI 2200PF 20% 400V	CT 57021	830100385800	SMD TRANS BC858B/BC857B
C 62549 △	866009623400	KERKO SI 1000PF 20% 400V	CT 57112	830100385800	SMD TRANS BC858B/BC857B
C 81063	814054010400	EMIFIL 0,1 UF -GR	CT 57113	830100385800	SMD TRANS BC858B/BC857B
			CT 57124	830100484800	SMD TRANS BC848B/BC847B
CD 80501	830940159200	SMD DIODE BA591	CT 61043	830100484800	SMD TRANS BC848B/BC847B

ÄNDERUNGEN VORBEHALTEN / SUBJECT TO ALTERATION

GRUNDIG**TV**

POS. NR. POS. NO.	MATERIAL-NR. PART NUMBER	BEZEICHNUNG DESCRIPTION	POS. NR. POS. NO.	MATERIAL-NR. PART NUMBER	BEZEICHNUNG DESCRIPTION
CT 61053	830100484800	SMD TRANS BC848B/BC847B	L 81061	810498205100	FERRITPERLE HF55 BTL 3,5X
CT 81220	830100484800	SMD TRANS BC848B/BC847B			FERRITE BEAD
CT 81225	830100484800	SMD TRANS BC848B/BC847B	L 81062	814052636100	DR 0411 10UH 5%
CT 85502	830100385800	SMD TRANS BC858B/BC857B	L 81064	814052636100	DR 0411 10UH 5% CHOKE
D 40584	830921504500	DIODE 1N4148	Q 34043	838212104400	QUARZ 4,433619MHZ
D 40586	830921504500	DIODE 1N4148	Q 34044	838204900300	QUARZ 3,579545MHZ
D 43055	830921504500	DIODE 1N4148	Q 80001	838208004000	QUARZ 4MHZ
D 43056	830921504500	DIODE 1N4148	Q 80951	838216204100	QUARZ 4MHZ
D 50023	830921502000	DIODE 1N4004	R 40551	873229240700	DRW 4 1,8 OHM 10%
D 50048	830970301400	Z-DIODE ZPY5,6 2%	R 43006	870001124600	KSW 0204 75 OHM 5%
D 52001	830921504500	DIODE 1N4148	R 50047	876642460200	MSW 0207 1,1 OHM 1%
D 53003	830920100500	DIODE BA157	R 50048 △	870552103300	MOW 0411 22 OHM 5%
D 54001	830920426800	DIODE BYV16	R 50050 △	870522705300	MOW 0411 150 OHM 5%
D 54011	830920100500	DIODE BA157	R 52004 △	870552105300	MOW 0411 150 OHM 5%
D 54022	830972033000	Z-DIODE 30B 0,5W	R 53002 △	870042909700	KSW NB 0207 10 KOHM 5%
D 57013	830921504500	DIODE 1N4148	R 53009	871033814500	MGW AX 1 MOHM 5%
D 57023	830921504500	DIODE 1N4148	R 53011 △	870552102100	MOW 0411 6,8 OHM 5%
D 60506 △	830951685400	DIODE BYT53B	R 53016	873018942500	DRW 9 10 OHM 10%
D 60509 △	830966318000	Z-DIODE BZT03D180	R 53021 △	870522707100	MOW 0411 820 OHM 5%
D 60512	830951675400	DIODE BYT53B	R 53033 △	870552100500	MOW 0411 1,5 OHM 5%
D 60523	830856038400	GLR.SKB380C1500	R 53074 △	870556107200	MOW 0617 820 OHM 5%
D 61016 △	830951717800	DIODE BYW178	R 54001 △	870552102500	MOW 0411 10 OHM 5%
D 61036 △	830951710800	DIODE BYT108-400	R 54006 △	870552100900	MOW 0411 2,2 OHM 5%
D 61056 △	830951717200	DIODE BYW172D	R 54022 △	870556111100	MOW 0617 38 KOHM 5%
D 85001	830994460100	LE DIODE TLHR4601	R 60502	870006935600	KSW 0617 3 MOHM 2%
F 32109	860275654200	KERTRAP #542 6MHZ	R 60504	870006934700	KSW 0617 1,2 MOHM 2%
F 32410	814110760100	SPULLE 7X7 #601 SIGN107601	R 60508 △	870556110500	MOW 0617 22 KOHM 5%
F 32412	831900198000	OPFWIL J1980 SIE	R 60509 △	870556110500	MOW 0617 22 KOHM 5%
F 34052	814111675000	FILTER 7X7 #750 SIGN11675	R 60516	879005004600	ESTR.SK10-A 4,7 KOHM LIN
IC 34015	830512524800	IC STV2248	R 61018 △	870552111900	MOW 0411 82 KOHM 5%
IC 40550	830534726600	IC TDA7266B	R 62501 △	831120001600	PTC DUO T251-A80-A10
IC 50010	830533817400	IC TDA8174AW	R 62502	831100501700	NTC 4,7 OHM 30%
IC 60510	830533464600	IC TDA16846	R 62549 △	876504916100	MSW SI 0414 4,7 MOHM
IC 61040	830520431700	IC LM317T	SI 40551 △	831561902800	SI LOET T1,6A 250V
IC 61050	830520431700	IC LM317T	SI 62501 △	831561700600	SI SX20 T2,5A L 250V
IC 61060	830520570300	IC MC7805CT	T 52001	830328563700	TRANS BC637
IC 80500	830521006500	IC MC33164P-5RP	T 53001	830290002000	TRANS S2055N
IC 80920	297980200400	IC Z7C020 PROG.KPL	T 60506	830280504000	TRANS IRFBC40
IC 81500	293052193000	PROZESSORPLATTE			
WW.	830415507200	IC ST92195C9B1-S232	TR 52001	092468680400	TRAFO TREIBER TRANSFORMER DRIVER
IC 84501	830546133000	IC TSOP1330	TR53010 △	292210315700	TRAFO DIODEN-SPLIT
			WW. △	292016651101	TRAFO DIODEN-SPLIT
L 31043	814052644000	DR ST 0411-GRP 8,2UH 10%	TR61000 △	292015219703	TRANSFORMER DIODE SPLIT SPERRWANDLERTRAFO B.O.TYPE CONVERTER TRANSFORMER
L 32023	814052655300	DR 0411 33UH 10%			
L 32026	814052655300	DR 0411 33UH 10%			
L 32109	814052690600	DR 0309 4,7UH 10%			
L 40512	814050525900	DR A AX-GA 27UH 10%			
L 52251	814051174900	DR AX 0411-GA 10UH 10%			
L 52256	814052632000	DR AX 0411-GA 3,3UH 10% CHOKE			
L 53003	810498205600	FERRITPERLE HF70 BTL 3,5X FERRITE BEAD			
L 53011	814050524900	DR A AX-GA 10UH 10% CHOKE			
L 53021	292031149500	LINEARITAETSREGLER LINEARITY CONTROL			
L 53074	092468700101	ZB-SPULLE ZB COIL			
L 60506	810498205700	FERRITPERLE 3,6UH 5720500			
L 61038	810498200300	FERRITPERLE BL02RN2-R62 FERRITE BEAD			
L 62501 △	295008269700	FUNKENTSTOERDROSSEL INTERFERENCE CHOKE			

Es gelten die Vorschriften und Sicherheitshinweise gemäß dem Service Manual "Sicherheit", Mat.-Nummer 720108000000, sowie zusätzlich die eventuell abweichenden, landesspezifischen Vorschriften!



The regulations and safety instructions shall be valid as provided by the "Safety" Service Manual, part number 720108000000, as well as the respective national deviations.

ÄNDERUNGEN VORBEHALTEN / SUBJECT TO ALTERATION

Ersatzteilliste Spare Parts List

11 / 2001

GRUNDIG

TV

CHASSIS-FS-STEREO CUC 2121 INL/DOLBY CHASSIS TV STEREO CUC 2121 INL/DOLBY

MATERIAL-NR. / PART NO.: 297040135400

POS. NR. POS. NO.	ABB. FIG.	MATERIAL-NR. PART NUMBER	ANZ. QTY.	BEZEICHNUNG (D)	DESCRIPTION (GB)
		297040135400		CHASSIS-FS-STEREO CUC 2121 INL/DOLBY KEIN E-TEIL	CHASSIS TV STEREO CUC 2121 INL/DOLBY NO SPARE PART
0100.000		295045010100		TUNER-PLL STEHEND	TUNER-PLL TOP ENTRY
0216.000		297033571100		TASTSCHALTER PROGRAMM+	KEY SWITCH PROGRAMME+
0216.000		297033571100		TASTSCHALTER PROGRAMM-	KEY SWITCH PROGRAMME-
0216.000		297033571100		TASTSCHALTER LAUTSTAERKE+	KEY SWITCH VOLUME+
0216.000		297033571100		TASTSCHALTER LAUTSTAERKE-	KEY SWITCH VOLUME-
0240.000		293033904200		KOPFHOERERBUCHSE 3,5 O.SCHALTER	HEADPHONE SOCKET 3,5 W/O SWITCH
0241.000		293031680503		CINCH-BUCHSE 3-FACH FBAS/NF L,R	CINCH SOCKET 3 FOLD FBAS/AF L,R
0247.000		293031196003		EURO-AV BUCHSENLEISTE 21-POL.SW	EURO-AV SOCKET STRIP 21 P BLACK
0312.000		297006430104		ABDECKUNG EURO-AV	COVER EURO AV
0500.000		295041028300	X	BAUSTEIN STEREO MODUL	MODULE STEREO
0910.000		292107030101		FOKUSLEITUNG	FOCUSING CABLE
1000.000	△	096211130206	2	SICHERUNGSHALTER SI62501	FUSE HOLDER SI62501
2000.000	△	297033910600		NETZSCHALTER O.WISCHER	POWER SWITCH W/O WIPER
2200.000	△	293033995100		NETZ EINBAUGERAETESTECKER	APPLIANCE COUPLER W.CABLE
2400.000		293031530107		MONTAGECLIP IC40550	MOUNTING CLIP IC40550
2410.000		293031530208	2	MONTAGECLIP IC50010/T53001	MOUNTING CLIP IC50010/T53001
2420.000		293031531600		MONTAGECLIP T60506	MOUNTING CLIP T60506
2430.000		293031531605	3	MONTAGECLIP IC61040/61050/61060	MOUNTING CLIP IC61040/61050/61060
2450.000		293031562000	4	FOLIE WAERMELEITEND	FOIL HEAT CONDUCTING
				IC61040/61050/61060/T60506	IC61040/61050/61060/T60506
				WW.=WAHLWEISE X=SIEHE GESONDERTE E-LISTE	WW.=OPTIONAL X=SEE SEPARATE PARTS LIST

POS. NR. POS. NO.	MATERIAL-NR. PART NUMBER	BEZEICHNUNG DESCRIPTION	POS. NR. POS. NO.	MATERIAL-NR. PART NUMBER	BEZEICHNUNG DESCRIPTION
C 34026	845296706400	ELKO 1000UF +50-20% 10V	C 81063	814054010400	EMIFIL 0,1 UF
C 40557	845299610700	ELKO 2200UF 20% 16V	CD 80501	830940159200	SMD DIODE BA591/BA592/BA782S
C 50047	845299618700	ELKO 1000UF 20% 35V	CIC 80910	830581409400	SMD IC MC14094BD
C 50048	845299864700	ELKO 1000UF 20% 25V	CIC 80930	830595012900	SMD IC ST92R195C9Q1
C 53002	851591111400	FOKO KF #35 9000PF 3,5% 1500V	CIC 82501	830596000800	SMD IC M24C08CM1TR
C 54011	865006704600	KERKO HV C 100PF 20% 1KV	CL 40511	810498233100	SMD DAEMPF-PERLE 0805
C 54012	845299618700	ELKO 1000UF 20% 35V	CT 32124	830100385800	SMD TRANS BC858B/ BC857B
C 60501	865008112500	KERKO HV C 1000PF 20% 1KV	CT 34031	830100385800	SMD TRANS BC858B/ BC857B
C 60509	851591104500	FOKO FKP1 680PF 10% 1600V	CT 40581	830100385800	SMD TRANS BC858B/ BC857B
C 60512	865008111100	KERKO HV C 270PF 20% 2KV	CT 43010	830100385800	SMD TRANS BC858B/ BC857B
C 60523	865008112500	KERKO HV C 1000PF 20% 1KV	CT 43015	830100484800	SMD TRANS BC848B/ BC847B
C 60524	865008112500	KERKO HV C 1000PF 20% 1KV	CT 50005	830100484800	SMD TRANS BC848B/ BC847B
C 60526	865008112500	KERKO HV C 1000PF 20% 1KV	CT 50015	830100484800	SMD TRANS BC848B/ BC847B
C 60527	865008112500	KERKO HV C 1000PF 20% 1KV	CT 50040	830100484800	SMD TRANS BC848B/ BC847B
C 60528	845209711550	ELKO SNT #40 150UF 385V/400V	CT 50050	830100484800	SMD TRANS BC848B/ BC847B
WW.	845199711550	ELKO 19 150UF 385V	CT 50055	830100484800	SMD TRANS BC848B/ BC847B
C 61016	851591104000	FOKO FKP1 220PF 10% 1600V	CT 50055	830100484800	SMD TRANS BC848B/ BC847B
C 61036	865006704600	KERKO HV C 100PF 20% 1KV	CT 52260	830100385800	SMD TRANS BC858B/ BC857B
C 61056	865006704600	KERKO HV C 100PF 20% 1KV	CT 57020	830100385800	SMD TRANS BC858B/ BC857B
C 62501	851179301800	FOKO MP3 0,1UF 20% 275VW	CT 57021	830100385800	SMD TRANS BC858B/ BC857B
C 62521	866009623800	KERKO SI 2200PF 20%			
C 62522	866009623800	KERKO SI 2200PF 20%			
C 62549	866009623400	KERKO SI 1000PF 20%			

ÄNDERUNGEN VORBEHALTEN / SUBJECT TO ALTERATION

POS. NR. POS. NO.	MATERIAL-NR. PART NUMBER	BEZEICHNUNG DESCRIPTION	POS. NR. POS. NO.	MATERIAL-NR. PART NUMBER	BEZEICHNUNG DESCRIPTION
CT 57112	830100385800	SMD TRANS BC858B/ BC857B	L 62501	295008269700	FUNKENTSTOERDROSSEL RK19 INTERFERENCE SUPPR. CHOKE
CT 57113	830100385800	SMD TRANS BC858B/ BC857B	L 81061	810498205100	FERRITPERLE HF55 BTL 3,5X4,5 FERRITE BEAD
CT 57124	830100484800	SMD TRANS BC848B/ BC847B	L 81062	814052636100	DR 0411 10UH 5%
CT 61043	830100484800	SMD TRANS BC848B/ BC847B	L 81064	814052636100	DR 0411 10UH 5%
CT 61053	830100484800	SMD TRANS BC848B/ BC847B	Q 34043	838212104400	QUARZ 4.433619 MHZ
CT 81220	830100484800	SMD TRANS BC848B/ BC847B	Q 80001	838208004000	QUARZ 4 MHZ
CT 81225	830100484800	SMD TRANS BC848B/ BC847B	Q 80951	838216204100	QUARZ 4 MHZ
CT 85502	830100385800	SMD TRANS BC858B/ BC857B	R 40551	873229240700	DRW 4 1,8 OHM 10%
D 40584	830921504500	DIODE 1N4148	R 43006	870001124600	KSW 0204 75 OHM 5%
D 40586	830921504500	DIODE 1N4148	R 50047	876642460200	MSW 0207 1,1 OHM 1% ST
D 43055	830921504500	DIODE 1N4148	R 50048	870552103300	MOW 0411 22 OHM 5% LI
D 43056	830921504500	DIODE 1N4148	R 50050	870522705300	MOW 0411 150 OHM 5% LI
D 50023	830921502000	DIODE 1N4004	R 52004	870552105300	MOW 0411 150 OHM 5% LI
D 50048	830970301400	Z-DIODE ZPY5,6 2%	R 53002	870042909700	KSW NB 0207 10 KOHM 5% ST
D 52001	830921504500	DIODE 1N4148	R 53009	871033814500	MGW AX 1 MOHM 5%
D 53003	830920100500	DIODE BA157	R 53011	870552102100	MOW 0411 6,8 OHM 5% LI
D 54001	830920426800	DIODE BYV16	R 53016	873018942500	DRW 9 10 OHM 10%
D 54011	830920100500	DIODE BA157	R 53021	870522707100	MOW 0411 820 OHM 5%
D 54022	830972033000	Z-DIODE 30 B 0,5W	R 53033	870552100500	MOW 0411 1,5 OHM 5% LI
D 57013	830921504500	DIODE 1N4148	R 53074	870556107100	MOW 0411 820 OHM 5% LI
D 57023	830921504500	DIODE 1N4148	R 54001	870552102500	MOW 0411 10 OHM 5% LI
D 60506	830951685400	DIODE BYT 54 M	R 54006	870552100900	MOW 0411 2,2 OHM 5% LI
D 60509	830966318000	Z-DIODE BZT03D180	R 54022	870556111100	MOW 0617 39 KOHM 5% LI
D 60512	830951675400	DIODE BYT53B	R 60502	870006934700	KSW 0617 3 MOHM 2%
D 60523	830856038400	GLR.SKB380C1500	R 60504	870006934700	KSW 0617 1,2 MOHM 2%
D 61016	830951717800	DIODE BYW178	R 60508	870556110500	MOW 0617 22 KOHM 5% LI
D 61037	830951710800	DIODE BYT108-400	R 60509	870556110500	MOW 0617 22 KOHM 5% LI
D 61056	830951717200	DIODE BYW172D	R 60516	879005004600	ESTR.SK10-A 4,7 KOHM LIN
D 85511	830994460100	LE DIODE TLHR 4601	R 61018	870552111900	MOW 0411 82 KOHM 5% LI
F 32109	860275652100	KERTRAP #521 5,5MHZ	R 62501	831120001600	PTC DUO T251-A80-A10
F 32410	814110760100	SPULE 7X7 #601	R 62502	831100501700	NTC 4,7 OHM 30%
F 32412	831900198400	OFFFIL G1985M	R 62549	876504916100	MSW SI 0414 4,7 MOHM VDE
F 34052	814111675000	FILTER 7X7 #750	SI 40551	831561902800	SI LOET T1,6A 250V
IC 34015	830512524600	IC STV2246	SI 62501	831561700600	SI 5X20 T2,5A L 250V
IC 40550	830534726600	IC TDA7266B	T 52001	830328563700	TRANS.BC 637
IC 50010	830533817500	IC TDA8174AW	T 53001	830290002000	TRANS S2055N/ BU508DF
IC 60510	830533464600	IC TDA16846	T 60506	830280504000	TRANS.IRF BC 40 IOR ZNG.2
IC 61040	830520431700	IC LM317T	TR 52001	092468680400	TRAFO TREIBER DRIVER TRANSFORMER
IC 61050	830520431700	IC LM317T	TR 53010	292210315700	TRAFO DIODEN-SPLIT KPL DIODE DIODEN-TRANSFORMER CPL
IC 61060	830520570300	IC MC7805CT	TR 53020	292016651101	DIODEN-SPLIT TRAFO DIODE SPLIT TRANSFORMER
IC 80500	830521006500	IC MC33164P-5RP	TR 61000	292015219703	DIODE SPLIT TRANSFORMER SPERRWANDLERTRAFO REVERSE CONVERTER TRANSFORMER
IC 80920	297980310100	IC 27C020 PROG.KPL			
IC 81500	293052194100	PROZESSORPLATTE			
WW.	830415512200	IC ST92195C9B1-S242			
IC 84501	830546133000	IC TSOP1330			
L 31043	814052644000	DR ST 0411-GRP 8,2UH 10%			
L 32023	814052653000	DR 0411 33UH 10%			
L 32026	814052653000	DR 0411 33UH 10%			
L 32109	814052696000	DR 0309 4,7UH 10% ST			
L 40512	814050525900	DR A AX-GA 27UH 10%			
L 52251	814051174900	DR AX 0411-GA 10UH 10%			
L 52256	814052632000	DR AX 0411-GA 3,3UH 10%			
L 53003	810498205600	FERRITPERLE HF70 BTL 3,5X6 FERRITE BEAD			
L 53011	814050524900	DR A AX-GA 10UH 10%			
L 53021	292031149500	LINEARITAETSREGLER LINEARITY CONTROL			
L 53074	092468700101	ZB-SPULE/ZB COIL			
L 60506	810498205700	FERRITPERLE 3,6UH FERRITE BEAD			
L 61038	810498200300	FERRITPERLE BL02RN2-R62			

Es gelten die Vorschriften und Sicherheitshinweise gemäß dem Service Manual "Sicherheit", Mat.-Nummer 720108000000, sowie zusätzlich die eventuell abweichenden, landesspezifischen Vorschriften!



The regulations and safety instructions shall be valid as provided by the "Safety" Service Manual, part number 720108000000, as well as the respective national deviations.

ÄNDERUNGEN VORBEHALTEN / SUBJECT TO ALTERATION

Ersatzteilliste
Spare Parts List

11 / 2001

CHASSIS-FS-STEREO CUC 2121 INL/DOLBY
CHASSIS TV STEREO CUC 2121 INL/DOLBY

MATERIAL-NR. / PART NO.: 297040135500

POS. NR. POS. NO.	ABB. FIG.	MATERIAL-NR. PART NUMBER	ANZ. QTY.	BEZEICHNUNG (D)	DESCRIPTION (GB)
		297040135500		CHASSIS-FS-STEREO CUC 2121 INL/DOLBY KEIN E-TEIL	CHASSIS TV STEREO CUC 2121 INL/DOLBY NO SPARE PART
0100.000		295045010100		TUNER-PLL STEHEND	TUNER-PLL TOP ENTRY
0216.000		297033571100		TASTSCHALTER PROGRAMM+	KEY SWITCH PROGRAMME+
0216.000		297033571100		TASTSCHALTER PROGRAMM-	KEY SWITCH PROGRAMME-
0216.000		297033571100		TASTSCHALTER LAUTSTAERKE+	KEY SWITCH VOLUME+
0216.000		297033571100		TASTSCHALTER LAUTSTAERKE-	KEY SWITCH VOLUME-
0240.000		293033904200		KOPFHOERERBUCHSE 3,5 O.SCHALTER	HEADPHONE SOCKET 3,5 W/O SWITCH
0241.000		293031680503		CINCH-BUCHSE 3-FACH FBAS/NF L,R	CINCH SOCKET 3 FOLD FBAS/AF L,R
0247.000		293031190603		EURO-AV BUCHSENLEISTE 21-POL.SW	EURO-AV SOCKET STRIP 21 P BLACK
0312.000		297006430104		ABDECKUNG EURO-AV	COVER EURO AV
0500.000		295041028300	X	BAUSTEIN STEREO MODUL	MODULE STEREO
0910.000	△	292107030101		FOKUSLEITUNG	FOCUSING CABLE
1000.000	△	096211130206	2	SICHERUNGSHALTER SI62501	FUSE HOLDER SI62501
2000.000	△	297030391060		NETZSCHALTER O.WISCHER	POWER SWITCH W/O WIPER
2200.000	△	293033995100		NETZ EINBAUGERAETESTECKER	APPLIANCE COUPLER W.CABLE
2400.000		293031530107		MONTAGECLIP IC40550	MOUNTING CLIP IC40550
2410.000		293031530208	2	MONTAGECLIP IC50010/T53001	MOUNTING CLIP IC50010/T53001
2420.000		293031531600		MONTAGECLIP T60506	MOUNTING CLIP T60506
2430.000		293031531605	3	MONTAGECLIP IC61040/61050/61060	MOUNTING CLIP IC61040/61050/61060
2450.000		293031562000	4	FOLIE WAERMELEITEND	FOIL HEAT CONDUCTING
				IC61040/61050/61060/T60506	IC61040/61050/61060/T60506
				WW.=WAHLWEISE X=SIEHE GESONDERTE E-LISTE	WW.=OPTIONAL X=SEE SEPARATE PARTS LIST

POS. NR. POS. NO.	MATERIAL-NR. PART NUMBER	BEZEICHNUNG DESCRIPTION	POS. NR. POS. NO.	MATERIAL-NR. PART NUMBER	BEZEICHNUNG DESCRIPTION
C 34026	845296706400	ELKO 1000UF +50-20% 10V	CD 80501	830940159200	SMD DIODE BA591/BA592/BA782S
C 40557	845299610700	ELKO 2200UF 20% 16V	CIC 80910	830581409400	SMD IC MC14094BD
C 50047	845299618700	ELKO 1000UF 20% 35V	CIC 80930	830595012900	SMD IC ST92R195C9Q1
C 50048	845299864700	ELKO 1000UF 20% 25V	CIC 82501	830596000800	SMD IC M24C08CM1TR
C 53002	851591111400	FOKO KF #35 9000PF 3,5% 1500V	CL 40511	810498233100	SMD DAEMPF-PERLE 0805
C 54011	865006704600	KERKO HV C 100PF 20% 1KV	CT 32124	830100385800	SMD TRANS BC858B/ BC857B
C 54012	845299618700	ELKO 1000UF 20% 35V	CT 34031	830100385800	SMD TRANS BC858B/ BC857B
C 60501	865008112500	KERKO HV C 1000PF 20% 1KV	CT 40581	830100385800	SMD TRANS BC858B/ BC857B
C 60509	851591104500	FOKO FKP1 680PF 10% 1600V	CT 43010	830100385800	SMD TRANS BC858B/ BC857B
C 60512	865008111100	KERKO HV C 270PF 20% 2KV	CT 43015	830100484800	SMD TRANS BC848B/ BC847B
C 60523	865008112500	KERKO HV C 1000PF 20% 1KV	CT 50005	830100484800	SMD TRANS BC848B/ BC847B
C 60524	865008112500	KERKO HV C 1000PF 20% 1KV	CT 50015	830100484800	SMD TRANS BC848B/ BC847B
C 60526	865008112500	KERKO HV C 1000PF 20% 1KV	CT 50040	830100484800	SMD TRANS BC848B/ BC847B
C 60527	865008112500	KERKO HV C 1000PF 20% 1KV	CT 50050	830100484800	SMD TRANS BC848B/ BC847B
C 60528	845209711500	ELKO SNT #40 150UF 385V/400V	CT 50055	830100484800	SMD TRANS BC848B/ BC847B
WW.	845199711550	ELKO 19 150UF 385V	CT 50505	830100484800	SMD TRANS BC848B/ BC847B
C 61016	851591104000	FOKO FKP1 220PF 10% 1600V	CT 50555	830100484800	SMD TRANS BC848B/ BC847B
C 61036	865006704600	KERKO HV C 100PF 20% 1KV	CT 52260	830100385800	SMD TRANS BC858B/ BC857B
C 61056	865006704600	KERKO HV C 100PF 20% 1KV	CT 57020	830100385800	SMD TRANS BC858B/ BC857B
C 62501	851179301800	FOKO MP3 0,1UF 20% 275VWV	CT 57021	830100385800	SMD TRANS BC858B/ BC857B
C 62521	866009623800	KERKO SI 2200PF 20%	CT 57112	830100385800	SMD TRANS BC858B/ BC857B
C 62522	866009623800	KERKO SI 2200PF 20%	CT 57113	830100385800	SMD TRANS BC858B/ BC857B
C 62549	866009623400	KERKO SI 1000PF 20%	CT 57124	830100484800	SMD TRANS BC848B/ BC847B
C 81063	814054010400	EMIFIL 0,1 UF			

ÄNDERUNGEN VORBEHALTEN / SUBJECT TO ALTERATION

GRUNDIG

TV

POS. NR. POS. NO.	MATERIAL-NR. PART NUMBER	BEZEICHNUNG DESCRIPTION
CT 61043	830100484800	SMD TRANS BC848B/ BC847B
CT 61053	830100484800	SMD TRANS BC848B/ BC847B
CT 81220	830100484800	SMD TRANS BC848B/ BC847B
CT 81225	830100484800	SMD TRANS BC848B/ BC847B
CT 85502	830100385800	SMD TRANS BC858B/ BC857B

D 40584	830921504500	DIODE 1N4148
D 40586	830921504500	DIODE 1N4148
D 43055	830921504500	DIODE 1N4148
D 43056	830921504500	DIODE 1N4148
D 50023	830921502000	DIODE 1N4004
D 50048	830970301400	Z-DIODE ZPY5.6 2%
D 52001	830921504500	DIODE 1N4148
D 53003	830920100500	DIODE BA157
D 54001	830920426800	DIODE BYV16
D 54011	830920100500	DIODE BA157
D 54022	830972033000	Z-DIODE 30 B 0,5W
D 57013	830921504500	DIODE 1N4148
D 57023	830921504500	DIODE 1N4148
D 60506	830951685400	DIODE BYT 54 M
D 60509	830966318000	Z-DIODE BZT03D180
D 60512	830951675400	DIODE BYT53B
D 60523	830856038400	GLR.SK380C1500
D 61016	830951717800	DIODE BYW178
D 61037	830951710800	DIODE BYT108-400
D 61056	830951717200	DIODE BYW172D
D 85511	830994460100	LE DIODE TLHR 4601

F 32109	860275652100	KERTRAP #521 5,5MHZ
F 32410	814110760100	SPULE 7X7 #601
F 32412	831900198400	OFWFIL G1985M
F 34052	814111675000	FILTER 7X7 #750

IC 34015	830512524600	IC STV2246
IC 40550	830534726600	IC TDA7266B
IC 50010	830533817500	IC TDA8174AW
IC 60510	830533464600	IC TDA16846
IC 61040	830520431700	IC LM317T
IC 61050	830520431700	IC LM317T
IC 61060	830520570300	IC MC7805CT
IC 80500	830521006500	IC MC33164P-5RP
IC 80920	297980310100	IC 27C020 PROG.KPL
IC 81500	293052194100	PROZESSORPLATTE
WW.	830415512200	IC ST92195C9B1-S242
IC 84501	830546133000	IC TSOP1330

L 31043	814052644000	DR ST 0411-GRP 8,2UH 10%
L 32023	814052653000	DR 0411 33UH 10%
L 32026	814052653000	DR 0411 33UH 10%
L 32109	814052690600	DR 0309 4,7UH 10% ST
L 40512	814050525900	DR A AX-GA 27UH 10%
L 52251	814051174900	DR AX 0411-GA 10UH 10%
L 52256	814052632000	DR AX 0411-GA 3,3UH 10%
L 53003	810498205600	FERRITPERLE HF70 BTL 3,5X6
L 53011	814050524900	DR A AX-GA 10UH 10%
L 53021	292031149500	LINEARITÄTSREGLER LINEARITY CONTROL
L 53074	092468700101	ZB-SPULE/ZB COIL
L 60506	810498205700	FERRITPERLE 3,6UH
L 61038	810498200300	FERRITPERLE BL02RN2-R62
L 62501	295008269700	FERRITE BEAD FUNKENTSTOERDROSSEL RK19 INTERFERENCE SUPPR. CHOKE
L 81061	810498205100	FERRITPERLE HF55 BTL 3,5X4,5 FERRITE BEAD

Es gelten die Vorschriften und Sicherheitshinweise gemäß dem Service Manual "Sicherheit", Mat.-Nummer 720108000000, sowie zusätzlich die eventuell abweichenden, landesspezifischen Vorschriften!



The regulations and safety instructions shall be valid as provided by the "Safety" Service Manual, part number 720108000000, as well as the respective national deviations.

ÄNDERUNGEN VORBEHALTEN / SUBJECT TO ALTERATION

Ersatzteilliste
Spare Parts List

11 / 2001

CHASSIS-FS-STEREO CUC 2121 INL/DOLBY
CHASSIS TV STEREO CUC 2121 INL/DOLBY

MATERIAL-NR. / PART NO.: 297040135600

POS. NR. POS. NO.	ABB. FIG.	MATERIAL-NR. PART NUMBER	ANZ. QTY.	BEZEICHNUNG (D)	DESCRIPTION (GB)
		297040135600		CHASSIS-FS-STEREO CUC 2121 INL/DOLBY KEIN E-TEIL	CHASSIS TV STEREO CUC 2121 INL/DOLBY NO SPARE PART
0100.000		295045010100		TUNER-PLL STEHEND	TUNER-PLL TOP ENTRY
0216.000		297033571100		TASTSCHALTER PROGRAMM+	KEY SWITCH PROGRAMME+
0216.000		297033571100		TASTSCHALTER PROGRAMM-	KEY SWITCH PROGRAMME-
0216.000		297033571100		TASTSCHALTER LAUTSTAERKE+	KEY SWITCH VOLUME+
0216.000		297033571100		TASTSCHALTER LAUTSTAERKE-	KEY SWITCH VOLUME-
0240.000		293033904200		KOPFHOERERBUCHSE 3,5 O.SCHALTER	HEADPHONE SOCKET 3,5 W/O SWITCH
0241.000		293031680503		CINCH-BUCHSE 3-FACH FBAS/NF L,R	CINCH SOCKET 3 FOLD FBAS/AF L,R
0247.000		293031196603		EURO-AV BUCHSENLEISTE 21-POL.SW	EURO-AV SOCKET STRIP 21 P BLACK
0312.000		297006430104		ABDECKUNG EURO-AV	COVER EURO AV
0500.000		295041028300		BAUSTEIN STEREO MODUL	MODULE STEREO
0910.000	△	292107030101		FOKUSLEITUNG	MODULING CABLE
1000.000	△	098211130206	2	SICHERUNGSHALTER SI62501	FUSE HOLDER SI62501
2000.000	△	297033910600		NETZSCHALTER O.WISCHER	POWER SWITCH W/O WIPER
2200.000	△	293033995100		NETZ EINBAUGERAETESTECKER	APPLIANCE COUPLER W.CABLE
2400.000		293031530107		MONTAGECLIP IC40550	MOUNTING CLIP IC40550
2410.000		293031530208	2	MONTAGECLIP IC50010/T53001	MOUNTING CLIP IC50010/T53001
2420.000		293031531600		MONTAGECLIP T60506	MOUNTING CLIP T60506
2430.000		293031531605	3	MONTAGECLIP IC61040/61050/61060	MOUNTING CLIP IC61040/61050/61060
2450.000		293031562000	4	FOIL WAERMELEITEND	FOIL HEAT CONDUCTING
				IC61040/61050/61060/T60506	IC61040/61050/61060/T60506
				WW.=WAHLWEISE	WW.=OPTIONAL
				X=SIEHE GESONDERTE E-LISTE	X=SEE SEPARATE PARTS LIST

POS. NR. POS. NO.	MATERIAL-NR. PART NUMBER	BEZEICHNUNG DESCRIPTION	POS. NR. POS. NO.	MATERIAL-NR. PART NUMBER	BEZEICHNUNG DESCRIPTION
C 34026	845296706400	ELKO 1000UF +50-20% 10V	CD 80501	830940159200	SMD DIODE BA591/BA592/BA782S
C 40557	845299610700	ELKO 2200UF 20% 16V			
C 50047	845299618700	ELKO 1000UF 20% 35V	CIC 80910	830581409400	SMD IC MC14094BD
C 50048	845299664700	ELKO 1000UF 20% 25V	CIC 80930	830595012900	SMD IC ST92R195C9Q1
C 53002	851591110200	FOKO FKP1/4 8500PF 3,5% 1500V	CIC 82501	830596000800	SMD IC M24C08CM1TR
C 54011	865006704600	KERKO HV C 100PF 20% 1KV			
C 54012	845299618700	ELKO 1000UF 20% 35V	CL 40511	810498233100	SMD DAEMPF-PERLE 0805
C 60501	865008112500	KERKO HV C 1000PF 20% 1KV			
C 60509	851591104500	FOKO FKP1 680PF 10% 1600V	CT 32124	830100385800	SMD TRANS BC858B/ BC857B
C 60512	865008111100	KERKO HV C 270PF 20% 2KV	CT 34031	830100385800	SMD TRANS BC858B/ BC857B
C 60523	865008112500	KERKO HV C 1000PF 20% 1KV	CT 40581	830100385800	SMD TRANS BC858B/ BC857B
C 60524	865008112500	KERKO HV C 1000PF 20% 1KV	CT 43010	830100385800	SMD TRANS BC858B/ BC857B
C 60526	865008112500	KERKO HV C 1000PF 20% 1KV	CT 43015	830100484800	SMD TRANS BC848B/ BC847B
C 60527	865008112500	KERKO HV C 1000PF 20% 1KV	CT 50005	830100484800	SMD TRANS BC848B/ BC847B
C 60528	845209711500	ELKO SNT #40 150UF 385V/400V	CT 50015	830100484800	SMD TRANS BC848B/ BC847B
WW.	845199711500	ELKO 19 150UF 385V	CT 50040	830100484800	SMD TRANS BC848B/ BC847B
C 61016	851591104000	FOKO FKP1 220PF 10% 1600V	CT 50050	830100484800	SMD TRANS BC848B/ BC847B
C 61036	865006704600	KERKO HV C 100PF 20% 1KV	CT 50055	830100484800	SMD TRANS BC848B/ BC847B
C 61056	865006704600	KERKO HV C 100PF 20% 1KV	CT 52260	830100385800	SMD TRANS BC858B/ BC857B
C 62501 △	851179301800	FOKO MP3 0,1UF 20% 275VW	CT 57020	830100385800	SMD TRANS BC858B/ BC857B
C 62521 △	866009623800	KERKO SI 2200PF 20%	CT 57021	830100385800	SMD TRANS BC858B/ BC857B
C 62522 △	866009623800	KERKO SI 2200PF 20%	CT 57112	830100385800	SMD TRANS BC858B/ BC857B
C 62549 △	866009623400	KERKO SI 1000PF 20%	CT 57113	830100385800	SMD TRANS BC858B/ BC857B
C 81063	814054010400	EMIFIL 0,1 UF	CT 57124	830100484800	SMD TRANS BC848B/ BC847B

ÄNDERUNGEN VORBEHALTEN / SUBJECT TO ALTERATION

GRUNDIG



POS. NR. POS. NO.	MATERIAL-NR. PART NUMBER	BEZEICHNUNG DESCRIPTION
CT 61043	830100484800	SMD TRANS BC848B/ BC847B
CT 61053	830100484800	SMD TRANS BC848B/ BC847B
CT 81220	830100484800	SMD TRANS BC848B/ BC847B
CT 81225	830100484800	SMD TRANS BC848B/ BC847B
CT 85502	830100385800	SMD TRANS BC858B/ BC857B
D 40584	830921504500	DIODE 1N4148
D 40586	830921504500	DIODE 1N4148
D 43055	830921504500	DIODE 1N4148
D 43056	830921504500	DIODE 1N4148
D 50023	830921502000	DIODE 1N4004
D 50048	830970301400	Z-DIODE ZPY5.6 2%
D 52001	830921504500	DIODE 1N4148
D 53003	830920100500	DIODE BA157
D 54001	830920426800	DIODE BYV16
D 54011	830920100500	DIODE BA157
D 54022	830972033000	Z-DIODE 30 B 0,5W
D 57013	830921504500	DIODE 1N4148
D 57023	830921504500	DIODE 1N4148
D 60506 △	830951685400	DIODE BYT 54 M
D 60509 △	830966318000	Z-DIODE BZT03D180
D 60512	830951675400	DIODE BYT53B
D 60523	830856038400	GLR.SK8380C1500
D 61016 △	830951717800	DIODE BYW178
D 61037 △	830951710800	DIODE BYT108-400
D 61056 △	830951717200	DIODE BYW172D
D 85511	830994460100	LE DIODE TLHR 4601
F 32109	860275652100	KERTRAP #521 5,5MHZ
F 32410	814110760100	SPULE 7X7 #601
F 32412	831900198400	OPFWIL G1985M
F 34052	814111675000	FILTER 7X7 #750
IC 34015	830512524600	IC STV2246
IC 40550	830534726600	IC TDA7266B
IC 50010	830533817500	IC TDA8174AW
IC 60510	830533464600	IC TDA16846
IC 61040	830520431700	IC LM317T
IC 61050	830520431700	IC LM317T
IC 61060	830520570300	IC MC7805CT
IC 80500	830521006500	IC MC33164P-5RP
IC 80920	297980310100	IC 27C020 PROG.KPL
IC 81500	293052194100	PROZESSORPLATTE
WW.	830415512200	IC ST92195C9B1-S242
IC 84501	830546133000	IC TSOP1330
L 31043	814052644000	DR ST 0411-GRP 8,2UH 10%
L 32023	814052653000	DR 0411 33UH 10%
L 32026	814052653000	DR 0411 33UH 10%
L 32109	814052690600	DR 0309 4,7UH 10% ST
L 40512	814050525900	DR A AX-GA 27UH 10%
L 52251	814051174900	DR AX 0411-GA 10UH 10%
L 52256	814052632000	DR AX 0411-GA 3,3UH 10%
L 53003	810498205600	FERRITPERLE HF70 BTL 3,5X6
		FERRITE BEAD
L 53011	814050524900	DR A AX-GA 10UH 10%
L 53021	292031149500	LINEARITAETSREGLER
		LINEARITY CONTROL
L 53074	092468700101	ZB-SPULE/ZB COIL
L 60506	810498205700	FERRITPERLE 3,6UH
L 61038	810498200300	FERRITPERLE BL02RN2-R62
		FERRITE BEAD
L 62501 △	295008269700	FUNKENTSTOERDROSSEL RK19
		INTERFERENCE SUPPR. CHOKE
L 81061	810498205100	FERRITPERLE HF55 BTL 3,5X4,5
		FERRITE BEAD

Es gelten die Vorschriften und Sicherheitshinweise gemäß dem Service Manual "Sicherheit", Mat.-Nummer 720108000000, sowie zusätzlich die eventuell abweichenden, landesspezifischen Vorschriften!



The regulations and safety instructions shall be valid as provided by the "Safety" Service Manual, part number 720108000000, as well as the respective national deviations.

ÄNDERUNGEN VORBEHALTEN / SUBJECT TO ALTERATION

GRUNDIG**TV**Ersatzteilliste
Spare Parts List**2 / 2002****CHASSIS-FS-STEREO CUC 2121 MUL/DOLBY
CHASSIS TV STEREO CUC 2121 MUL/DOLBY**

MATERIAL-NR. / PART NO.: 297040135700

POS. NR. POS. NO.	ABB. FIG.	MATERIAL-NR. PART NUMBER	ANZ. QTY.	BEZEICHNUNG (D)	DESCRIPTION (GB)
		297040135700		CHASSIS-FS-STEREO CUC 2121 MUL/DOLBY KEIN E-TEIL	CHASSIS TV STEREO CUC 2121 MUL/DOLBY NO SPARE PART
0100.000		295045010100		TUNER-PLL STEHEND	TUNER-PLL TOP ENTRY
0216.000		297033571100		TASTSCHALTER PROGRAMM+	KEY SWITCH PROGRAMME+
0216.000		297033571100		TASTSCHALTER PROGRAMM-	KEY SWITCH PROGRAMME-
0216.000		297033571100		TASTSCHALTER LAUTSTAERKE+	KEY SWITCH VOLUME+
0216.000		297033571100		TASTSCHALTER LAUTSTAERKE-	KEY SWITCH VOLUME-
0240.000		293033904200		KOPFHÖRERBUCHSE 3,5 O.SCHALTER	HEADPHONE SOCKET 3,5 W/O SWITCH
0241.000		293031680503		CINCH-BUCHSE 3-FACH FBAS/NF L,R	CINCH SOCKET 3 FOLD FBAS/AF L,R
0247.000		293031196603		EURO-AV BUCHSENLEISTE 21-POL SW	EURO-AV SOCKET STRIP 21 P BLACK
0312.000		297006430104		ABDECKUNG EURO-AV	COVER EURO AV
0500.000		295041028400	X	BAUSTEIN STEREO MODUL	STEREO MODULE
0910.000	△	292107030100		FOKUSLEITUNG	FOCUSING CABLE
1000.000	△	096211130206	2	SICHERUNGSHALTER SI62501	FUSE HOLDER SI62501
2000.000	△	297033910600		NETZSCHALTER O.WISCHER	POWER SWITCH W/O WIPER
2200.000	△	293033995100		NETZ EINBAUGERÄTESTECKER	APPLIANCE COUPLER W.CABLE
2400.000		293031530107		MONTAGECLIP IC40550	MOUNTING CLIP IC40550
2410.000		293031530208	2	MONTAGECLIP IC50010/T53001	MOUNTING CLIP IC50010/T53001
2420.000		293031531600		MONTAGECLIP T60506	MOUNTING CLIP T60506
2430.000		293031531605	3	MONTAGECLIP IC61040/61050/61060	MOUNTING CLIP IC61040/61050/61060
2450.000		293031562000	4	FOLIE WÄRMELEITEND	FOIL HEAT CONDUCTING
				IC61040/61050/61060/T60506	IC61040/61050/61060/T60506
				WW.=WAHLWEISE	WW.=OPTIONAL
				X=SIEHE GESONDERT E-LISTE	X=SEE SEPARATE PARTS LIST

POS. NR. POS. NO.	MATERIAL-NR. PART NUMBER	BEZEICHNUNG DESCRIPTION	POS. NR. POS. NO.	MATERIAL-NR. PART NUMBER	BEZEICHNUNG DESCRIPTION
C 34026	845296706400	ELKO 1000UF +50-20% 10V	C 81063	814054010400	EMIFIL 0,1 UF
C 40557	845299610700	ELKO 2200UF 20% 16V	CD 32411	830940159200	SMD DIODE BA591/BA592/BA782S
C 50047	845299618700	ELKO 1000UF 20% 35V	CD 32460	830940159200	SMD DIODE BA591/BA592/BA782S
C 50048	845299664700	ELKO 1000UF 20% 25V	CD 32470	830940159200	SMD DIODE BA591/BA592/BA782S
C 53002	851591111400	FOKO KF #35 9000PF 3,5% 1500V	CD 34041	830940159200	SMD DIODE BA591/BA592/BA782S
C 54011	865006704600	KERKO HV C 100PF 20% 1KV	CD 80501	830940159200	SMD DIODE BA591/BA592/BA782S
C 54012	845299618700	ELKO 1000UF 20% 35V	CIC 80910	830581409400	SMD IC MC14094BD
C 60501	865008112500	KERKO HV C 1000PF 20% 1KV	CIC 80930	830595012900	SMD IC ST92R195C9Q1
C 60509	851591104500	FOKO FKP1 680PF 10% 1600V	CIC 82501	830596000800	SMD IC M24C08CM1TR
C 60512	865008111100	KERKO HV C 270PF 20% 2KV	CL 40511	810498233100	SMD DAEMPF-PERLE 0805
C 60523	865008112500	KERKO HV C 1000PF 20% 1KV	CT 32111	830100484800	SMD TRANS BC848B/ BC847B
C 60524	865008112500	KERKO HV C 1000PF 20% 1KV	CT 32122	830100385800	SMD TRANS BC858B/ BC857B
C 60526	865008112500	KERKO HV C 1000PF 20% 1KV	CT 32123	830100484800	SMD TRANS BC848B/ BC847B
C 60527	865008112500	KERKO HV C 1000PF 20% 1KV	CT 32124	830100385800	SMD TRANS BC858B/ BC857B
C 60528	845209711500	ELKO SNT #40 150UF 385V/400V	CT 32132	830100484800	SMD TRANS BC848B/ BC847B
WW.	845199711500	ELKO 19 150UF 385V	CT 32460	830100484800	SMD TRANS BC848B/ BC847B
C 61016	851591104000	FOKO FKP1 220PF 10% 1600V	CT 32470	830100484800	SMD TRANS BC848B/ BC847B
C 61036	865006704600	KERKO HV C 100PF 20% 1KV	CT 32480	830100484800	SMD TRANS BC848B/ BC847B
C 61056	865006704600	KERKO HV C 100PF 20% 1KV	CT 34031	830100385800	SMD TRANS BC858B/ BC857B
C 62501 △	851179301800	FOKO MP3 0,1UF 20% 275VVV			
C 62521 △	866009623800	KERKO SI 2200PF 20%			
C 62522 △	866009623800	KERKO SI 2200PF 20%			
C 62549 △	866009623400	KERKO SI 1000PF 20%			

ÄNDERUNGEN VORBEHALTEN / SUBJECT TO ALTERATION

POS. NR. POS. NO.	MATERIAL-NR. PART NUMBER	BEZEICHNUNG DESCRIPTION	POS. NR. POS. NO.	MATERIAL-NR. PART NUMBER	BEZEICHNUNG DESCRIPTION
CT 40581	830100385800	SMD TRANS BC858B/ BC857B	L 52256	814052632000	DR AX 0411-GA 3,3UH 10%
CT 43010	830100385800	SMD TRANS BC858B/ BC857B	L 53003	810498205600	FERRITPERLE HF70 BTL 3,5X6
CT 43015	830100484800	SMD TRANS BC848B/ BC847B			FERRITE BEAD
CT 50005	830100484800	SMD TRANS BC848B/ BC847B	L 53011	814050524900	DR A AX-GA 10UH 10%
CT 50015	830100484800	SMD TRANS BC848B/ BC847B	L 53021	292031149500	LINEARITÄTSREGLER
CT 50040	830100484800	SMD TRANS BC848B/ BC847B			LINEARITY CONTROL
CT 50050	830100484800	SMD TRANS BC848B/ BC847B	L 53074	092468700101	ZB-SPULE/ZB COIL
CT 50055	830100484800	SMD TRANS BC848B/ BC847B	L 60506	810498205700	FERRITPERLE 3,6UH
CT 52260	830100385800	SMD TRANS BC858B/ BC857B	L 61038	810498200300	FERRITPERLE BL02RN2-R62
CT 57020	830100385800	SMD TRANS BC858B/ BC857B			FERRITE BEAD
CT 57021	830100385800	SMD TRANS BC858B/ BC857B	L 62501 △	295008269700	FUNKENTSTÖRERDROSSEL RK19
CT 57112	830100385800	SMD TRANS BC858B/ BC857B			INTERFERENCE SUPPR. CHOKE
CT 57113	830100385800	SMD TRANS BC858B/ BC857B	L 81061	810498205100	FERRITPERLE HF55 BTL 3,5X4,5
CT 57124	830100484800	SMD TRANS BC848B/ BC847B			FERRITE BEAD
CT 61043	830100484800	SMD TRANS BC848B/ BC847B	L 81062	814052636100	DR 0411 10UH 5%
CT 61053	830100484800	SMD TRANS BC848B/ BC847B	L 81064	814052636100	DR 0411 10UH 5%
CT 81220	830100484800	SMD TRANS BC848B/ BC847B			
CT 81225	830100484800	SMD TRANS BC848B/ BC847B	Q 34043	838212104400	QUARZ 4,433619 MHZ
CT 85502	830100385800	SMD TRANS BC858B/ BC857B	Q 34044	838204900300	QUARZ 3,579545MHZ
			Q 80001	838208004000	QUARZ 4 MHZ
			Q 80951	838216204100	QUARZ 4 MHZ
D 40584	830921504500	DIODE 1N4148	R 40551	873229240700	DRW 4 1,8 OHM 10%
D 40586	830921504500	DIODE 1N4148	R 43006	870001124600	KSW 0204 7,5 OHM 5%
D 43055	830921504500	DIODE 1N4148	R 50047	876642460200	MSW 0207 1,1 OHM 1% ST
D 43056	830921504500	DIODE 1N4148	R 50048 △	870552103300	MOW 0411 22 OHM 5% LI
D 50023	830921502000	DIODE 1N4A004	R 50050 △	870522705300	MOW 0411 1,5 OHM 5% LI
D 50048	830970301400	Z-DIODE ZPY5,6 2%	R 52004 △	870552105300	MOW 0411 150 OHM 5% LI
D 52001	830921504500	DIODE 1N4148	R 53002 △	870042909700	KSW NB 0207 10 KOHM 5% ST
D 53003	830920100500	DIODE BA157	R 53009	871033814500	MGW AX 1 MOHM 5%
D 54001	830920426800	DIODE BYV16	R 53011 △	870552102100	MOW 0411 6,8 OHM 5% LI
D 54011	830920100500	DIODE BA157	R 53016	873018942500	DRW 9 10 OHM 10%
D 54022	830972033000	Z-DIODE 30 B 0,5W	R 53021 △	870522707100	MOW 0411 820 OHM 5%
D 57013	830921504500	DIODE 1N4148	R 53033 △	870552100500	MOW 0411 1,5 OHM 5% LI
D 57023	830921504500	DIODE 1N4148	R 53074 △	870556107100	MOW 0617 820 OHM 5% LI
D 60506 △	830951685400	DIODE BYT 54 M	R 54001 △	870552102500	MOW 0411 2,2 OHM 5% LI
D 60509 △	830966318000	Z-DIODE BZT03D180	R 54006 △	870552100900	MOW 0411 2,2 OHM 5% LI
D 60512	830951675400	DIODE BYT53B	R 54022 △	870556111100	MOW 0617 1,2 MOHM 2%
D 60523	830856038400	GLR.SKB380C1500	R 60502	870006935600	KSW 0617 3 MOHM 2%
D 61016 △	830951717800	DIODE BYW178	R 60504	870006934700	KSW 0617 1,2 MOHM 2%
D 61037 △	830951710800	DIODE BYT108-400	R 60508 △	870556110500	MOW 0617 22 KOHM 5% LI
D 61056 △	830951717200	DIODE BYW172D	R 60509 △	870556110500	MOW 0617 22 KOHM 5% LI
D 85511	830994460100	LE DIODE TLHR 4601	R 60516	879005004600	ESTR.SK10-A 4,7 KOHM LIN
F 32109	860275506600	KERTRAP #66 5,5/6,6,5MHZ	R 61018 △	870552111900	MOW 0411 82 KOHM 5% LI
F 32121	814111136000	FILTER 7X7 360	R 62501 △	831120001600	PTC DUO T251-A80-A10
F 32410	8140534445100	SPULE 7X7 #451	R 62502 △	831100501700	NTC 4,7 OHM 30%
F 32412	831900395300	OFWFL K3953M	R 62549 △	876504916100	MSW SI 0414 4,7 MOHM VDE
F 32430	831900465400	OFWFL K4654K	SI 40551 △	831561902800	SI LOET T1,6A 250V
F 34052	814111675000	FILTER 7X7 #750	SI 62501 △	831561700600	SI 5X20 T2,5A L 250V
IC 34015	830512524800	IC STV2248	T 52001	830328563700	TRANS.BC 637
IC 40550	830534726600	IC TDA7266B	T 53001	830290002000	TRANS.S2055N BU508DF
IC 50010	830533817500	IC TDA8174AW	T 60506	830280504000	TRANS.IRF BC 40 IOR ZNG.2
IC 60510	830533464600	IC TDA16846	TR 52001	092468880400	TRAFO TREIBER
IC 61040	830520431700	IC LM317T	TR 53010 △	292210315700	TRAFO DIODEN-SPLIT KPL
IC 61050	830520431700	IC LM317T	TR 53020 △	292016651101	DIODE SPLIT TRANSFORMER CPL
IC 61060	830520570300	IC MC7805CT	TR 53020 △	292016651101	DIODEN-SPLIT TRAFO
IC 80500	830521006500	IC MC33164P-5RP	TR 61000 △	292015219703	DIODE SPLIT TRANSFORMER SPERRWÄNDLERTRAFO
IC 80920	297980320100	IC 27C020 PROG.KPL			REVERSE CONVERTER
IC 81500	293052194200	PROZESSORPLATTE			
WW.	830415513200	IC ST92195C9B1-S252			
IC 84501	830546133000	IC TSOP1330			
L 31043	814052644000	DR ST 0411-GRP 8,2UH 10%			
L 32109	814052690600	DR 0309 4,7UH 10% ST			
L 40512	814050525900	DR A AX-GA 27UH 10%			
L 52251	814051174900	DR AX 0411-GA 10UH 10%			

Es gelten die Vorschriften und Sicherheitshinweise gemäß dem Service Manual "Sicherheit", Mat.-Nummer 720108000000, sowie zusätzlich die eventuell abweichenden, landesspezifischen Vorschriften!



The regulations and safety instructions shall be valid as provided by the "Safety" Service Manual, part number 720108000000, as well as the respective national deviations.

ÄNDERUNGEN VORBEHALTEN / SUBJECT TO ALTERATION

Ersatzteilliste
Spare Parts List

3 / 2002

GRUNDIG

TV

CHASSIS-FS-STEREO CUC 2121 INL DOLBY
CHASSIS TV STEREO CUC 2121 INL DOLBY

MATERIAL-NR. / PART NO.: 297040135800

Table with 4 columns: POS. NR. ABB. MATERIAL-NR. ANZ. BEZEICHNUNG, POS. NO. FIG. PART NUMBER QTY., (D) DESCRIPTION, (GB) DESCRIPTION. Includes parts like CHASSIS-FS-STEREO, TUNER-PLL STEHEND, and various electronic components.

Table with 4 columns: POS. NR. MATERIAL-NR. BEZEICHNUNG, POS. NR. MATERIAL-NR. BEZEICHNUNG, POS. NO. PART NUMBER DESCRIPTION, POS. NO. PART NUMBER DESCRIPTION. Lists electronic components such as ELKO capacitors, FOKO resistors, and SMD diodes.

ÄNDERUNGEN VORBEHALTEN / SUBJECT TO ALTERATION

Table with 4 columns: POS. NR. MATERIAL-NR. BEZEICHNUNG, POS. NR. MATERIAL-NR. BEZEICHNUNG, POS. NO. PART NUMBER DESCRIPTION, POS. NO. PART NUMBER DESCRIPTION. Lists electronic components such as SMD TRANS, DIODE, and FERRITE BEAD.

Es gelten die Vorschriften und Sicherheitshinweise gemäß dem Service Manual "Sicherheit", Mat.-Nummer 720108000000, sowie zusätzlich die eventuell abweichenden, landesspezifischen Vorschriften!



The regulations and safety instructions shall be valid as provided by the "Safety" Service Manual, part number 720108000000, as well as the respective national deviations.

ÄNDERUNGEN VORBEHALTEN / SUBJECT TO ALTERATION

Ersatzteilliste
Spare Parts List

3 / 2002

CHASSIS-FS-STEREO CUC 2121 INL DOLBY
CHASSIS TV STEREO CUC 2121 INL DOLBY

MATERIAL-NR. / PART NO.: 297040135900

POS. NR. POS. NO.	ABB. FIG.	MATERIAL-NR. PART NUMBER	ANZ. QTY.	BEZEICHNUNG (D)	DESCRIPTION (GB)
		297040135900		CHASSIS-FS-STEREO CUC 2121 INL DOLBY KEIN E-TEIL	CHASSIS TV STEREO CUC 2121 INL DOLBY NO SPARE PART
0100.000		295045010100		TUNER-PLL STEHEND	TUNER-PLL TOP ENTRY
0215.000		297033571100		TASTSCHALTER PROGRAMM +	KEY SWITCH PROGRAMME +
0215.000		297033571100		TASTSCHALTER PROGRAMM -	KEY SWITCH PROGRAMME -
0215.000		297033571100		TASTSCHALTER LAUTSTAERKE +	KEY SWITCH VOLUME +
0215.000		297033571100		TASTSCHALTER LAUTSTAERKE -	KEY SWITCH VOLUME -
0240.000		293033904200		KOPFHÖRERBUCHSE 3,5mm O.SCHALTER	HEADPHONE SOCKET 3,5mm W/O SWITCH
0241.000		293031680503		CINCH-BUCHSE 3-FACH FBAS/NF L,R	CINCH SOCKET 3 FOLD FBAS/AF L,R
0247.000		293031190603		EURO-AV BUCHSENLEISTE 21-POL SW	EURO-AV SOCKET STRIP 21 PIN BLACK
0312.000		297006430104		ABDECKUNG EURO-AV	COVER EURO AV
0500.000		295041028300	X	BAUSTEIN STEREO	MODULE STEREO
0910.000	△	292107030100		FOKUSLEITUNG	FOCUSING CABLE
1000.000	△	096211130206	2	SICHERUNGSHALTER SI62501	FUSE HOLDER SI62501
2000.000	△	297033910600		NETZSCHALTER O.WISCHER	POWER SWITCH W/O WIPER
2200.000	△	293033995100		NETZ EINBAUGERAETESTECKER	APPLIANCE COUPLER
2400.000		293031530107		MONTAGECLIP IC40550	MOUNTING CLIP IC40550
2410.000		293031530208	2	MONTAGECLIP IC50010/T53001	MOUNTING CLIP IC50010/T53001
2440.000		293031531600		MONTAGECLIP T60506	MOUNTING CLIP T60506
2445.000		293031531605	3	MONTAGECLIP IC61040/61050/61060	MOUNTING CLIP IC61040/61050/61060
2470.000		293031562000	4	FOLIE WAERMELEITEND IC61040/ 61050/61060/T60506	FOIL HEAT CONDUCTING IC61040/ 61050/61060/T60506
				X = SIEHE GESONDERTE E-LISTE WW. = WAHLWEISE	X = SEE SEPARATE PARTS LIST WW. = OPTIONAL

POS. NR. POS. NO.	MATERIAL-NR. PART NUMBER	BEZEICHNUNG DESCRIPTION	POS. NR. POS. NO.	MATERIAL-NR. PART NUMBER	BEZEICHNUNG DESCRIPTION
C 34026	845296706400	ELKO 1000UF +50-20% 10V	CD 80501	830940159200	SMD DIODE BA591
C 40557	845299610700	ELKO 2200UF 20% 16V	CIC 80910	830581409400	SMD IC MC14094BD
C 50047	845299618700	ELKO 1000UF 20% 35V	CIC 80930	830595012900	SMD IC ST92R195C9Q1
C 50048	845299864700	ELKO 1000UF 20% 25V	CL 40511	810498233100	SMD DAEMPF-PERLE 0805 BLM SMD DAMPING BEAD
C 53002	851591111400	FOKO KF #35 9000PF 3,5% 1500V	CT 32124	830100385800	SMD TRANS BC858B/BC857B
C 54011	865006704600	KERKO HV C 100PF 20% 1KV	CT 34031	830100385800	SMD TRANS BC858B/BC857B
C 54012	845299618700	ELKO 1000UF 20% 35V	CT 40581	830100385800	SMD TRANS BC858B/BC857B
C 60501	865008112500	KERKO HV C 1000PF 20% 1KV	CT 43010	830100385800	SMD TRANS BC858B/BC857B
C 60509	851591104500	FOKO FKP1 680PF 10% 1800V	CT 43015	830100484800	SMD TRANS BC848B/BC847B
C 60512	865008111100	KERKO HV C 270PF 20% 2KV	CT 50005	830100484800	SMD TRANS BC848B/BC847B
C 60523	865008112500	KERKO HV C 1000PF 20% 1KV	CT 50015	830100484800	SMD TRANS BC848B/BC847B
C 60524	865008112500	KERKO HV C 1000PF 20% 1KV	CT 50040	830100484800	SMD TRANS BC848B/BC847B
C 60526	865008112500	KERKO HV C 1000PF 20% 1KV	CT 50050	830100484800	SMD TRANS BC848B/BC847B
C 60527	865008112500	KERKO HV C 1000PF 20% 1KV	CT 50055	830100484800	SMD TRANS BC848B/BC847B
C 61016	851591104000	FOKO FKP1 220PF 10% 1600V	CT 52260	830100385800	SMD TRANS BC858B/BC857B
C 61036	865006704600	KERKO HV C 100PF 20% 1KV	CT 52620	830100385800	SMD TRANS BC858B/BC857B
C 61056	865006704600	KERKO HV C 100PF 20% 1KV	CT 57020	830100385800	SMD TRANS BC858B/BC857B
C 62501 △	851179301800	FOKO MP3 0,1UF 20% 275V	CT 57021	830100385800	SMD TRANS BC858B/BC857B
C 62521 △	866009623800	KERKO SI 2200PF 20% 400V	CT 57112	830100385800	SMD TRANS BC858B/BC857B
C 62522 △	866009623800	KERKO SI 2200PF 20% 400V	CT 57113	830100385800	SMD TRANS BC858B/BC857B
C 62549 △	866009623400	KERKO SI 1000PF 20% 400V			
C 81063	814054010400	EMIFIL 0,1 UF -GR			

ÄNDERUNGEN VORBEHALTEN / SUBJECT TO ALTERATION

GRUNDIG

TV

POS. NR. POS. NO.	MATERIAL-NR. PART NUMBER	BEZEICHNUNG DESCRIPTION	POS. NR. POS. NO.	MATERIAL-NR. PART NUMBER	BEZEICHNUNG DESCRIPTION
CT 57124	830100484800	SMD TRANS BC848B/BC847B	L 62501 △	295008269700	FUNKENTSTOERDROSSEL INTERFERENCE CHOKE
CT 61043	830100484800	SMD TRANS BC848B/BC847B	L 81061	810498205100	FERRITPEARLE HF55 BTL 3,5X FERRITE BEAD
CT 61053	830100484800	SMD TRANS BC848B/BC847B	L 81062	814052636100	DR 0411 10UH 5%
CT 81220	830100484800	SMD TRANS BC848B/BC847B	L 81064	814052636100	DR 0411 10UH 5% CHOKE
CT 81225	830100484800	SMD TRANS BC848B/BC847B	Q 34043	838212104400	QUARZ 4,433619MHZ
CT 85502	830100385800	SMD TRANS BC858B/BC857B	Q 80001	838208004000	QUARZ 4MHZ
			Q 80951	838216204100	QUARZ 4MHZ
D 40584	830921504500	DIODE 1N4148	R 40551	873229240700	DRW 4 1,8 OHM 10%
D 40586	830921504500	DIODE 1N4148	R 43006	870001124600	KSW 0204 75 OHM 5%
D 43055	830921504500	DIODE 1N4148	R 50047	876642460200	MSW 0207 1,1 OHM 1%
D 43056	830921504500	DIODE 1N4148	R 50048 △	870552103300	MOW 0411 22 OHM 5%
D 50023	830921502000	DIODE 1N4004	R 50050 △	870522705300	MOW 0411 6,8 OHM 5%
D 50048	830970301400	Z-DIODE ZPY5,6 2%	R 52004 △	870552105300	MOW 0411 150 OHM 5%
D 52001	830921504500	DIODE 1N4148	R 53002 △	870042909700	KSW NB 0207 10 KOHM 5%
D 53003	830920100500	DIODE BA157	R 53009	871033814500	MGW AX 1 MOHM 5%
D 54001	830920426800	DIODE BYV16	R 53011 △	870552102100	MOW 0411 6,8 OHM 5%
D 54011	830920100500	DIODE BA157	R 53016	873018942500	DRW 9 10 OHM 10%
D 54022	830972033000	Z-DIODE 30B 0,5W	R 53021 △	870522707100	MOW 0411 820 OHM 5%
D 57013	830921504500	DIODE 1N4148	R 53033 △	870552100500	MOW 0411 1,5 OHM 5%
D 57023	830921504500	DIODE 1N4148	R 53074 △	870556107100	MOW 0617 820 OHM 5%
D 60506 △	830951685400	DIODE BYT54M	R 54001 △	870552102500	MOW 0411 10 OHM 5%
D 60509 △	830966318000	Z-DIODE BZT03D180	R 54006 △	870552100900	MOW 0411 2,2 OHM 5%
D 60512	830951675400	DIODE BYT53B	R 54022 △	870556111100	MOW 0617 39 KOHM 5%
D 60523	830856038400	GLR.SKB380C1500	R 60502	870006935600	KSW 0617 3 MOHM 2%
D 61016 △	830951717800	DIODE BYW17C	R 60504	870006934700	KSW 0617 1,2 MOHM 2%
D 61036 △	830951710800	DIODE BYT108-400	R 60508 △	870556110500	MOW 0617 22 KOHM 5%
D 61056 △	830951717200	DIODE BYW17ZD	R 60509 △	870556110500	MOW 0617 22 KOHM 5%
D 85001	830996610000	LE-DIODE TLDRA4100	R 60516	879005004600	ESTR.SK10-A 4,7 KOHM LIN
F 32109	860275652100	KERTRAP #521 5,5MHZ	R 61018 △	870552111900	MOW 0411 82 KOHM 5%
F 32410	814110760100	SPLULE 7X7 #601 SIGN107601	R 62501 △	831120001600	PTC DUO T251-A80-A10
F 32412	831900198400	OFWFL G1985M	R 62502	831100501700	NTC 4,7 OHM 30%
F 34052	814111675000	FILTER 7X7 #750 SIGN11675	R 62549 △	876504916100	MSW SI 0414 4,7 MOHM
IC 34015	830512524600	IC STV2246	SI 40551 △	831561902800	SI LOET T1,6A 250V
IC 40550	830534726600	IC TDA7266B	SI 62501 △	831561700600	SI X2 250,2A L 250V
IC 50010	830533817500	IC TDA8174AW	T 52001	830328563700	TRANS BC637
IC 60510	830533464600	IC TDA16846	T 53001	830290002000	TRANS S2055N
IC 61040	830520431700	IC LM317T	T 60506	830280504000	TRANS IRFBC40
IC 61050	830520431700	IC LM317T	TR 52001	0924686880400	TRAFO TREIBER TRANSFORMER DRIVER
IC 61060	830520570300	IC MC7805CT	TR 53010 △	292210315700	TRAFO DIODEN-SPLIT TRAFO DIODEN-SPLIT
IC 80500	830521006500	IC MC33164P-5RP	WW. △	292016651101	TRANSFORMER DIODE SPLIT TRANSFORMER DIODE SPLIT
IC 80920	297980310100	IC 27C200 PROG.KPL	TR 61000 △	292015219703	SPERRWANDLERTRAFO B.O.TYPE CONVERTER TRANSFORMER
IC 81500	293052194100	PROZESSORPLATTE			
WW.	830415512200	IC ST92195C9B1-S242			
IC 84501	830546133000	IC TSOP1330			
L 31043	814052644000	DR ST 0411-GRP 8,2UH 10%			
L 32023	814052653000	DR 0411 33UH 10%			
L 32026	814052653000	DR 0411 33UH 10%			
L 32109	814052690600	DR 0309 4,7UH 10%			
L 40512	814050525900	DR A AX-GA 27UH 10%			
L 52251	814051174900	DR AX 0411-GA 10UH 10%			
L 52256	814052632000	DR AX 0411-GA 3,3UH 10% CHOKE			
L 53003	810498205600	FERRITPEARLE HF70 BTL 3,5X FERRITE BEAD			
L 53011	814050524900	DR A AX-GA 10UH 10% CHOKE			
L 53021	292031149500	LINEARITAETSREGLER LINEARITY CONTROL			
L 53074	092468700101	ZB-SPULE ZB COIL			
L 60506	810498205700	FERRITPEARLE 3,6UH 5720500			
L 61038	810498200300	FERRITPEARLE BL02RN2-R62 FERRITE BEAD			

Es gelten die Vorschriften und Sicherheitshinweise gemäß dem Service Manual "Sicherheit", Mat.-Nummer 720108000000, sowie zusätzlich die eventuell abweichenden, landesspezifischen Vorschriften!



The regulations and safety instructions shall be valid as provided by the "Safety" Service Manual, part number 720108000000, as well as the respective national deviations.

ÄNDERUNGEN VORBEHALTEN / SUBJECT TO ALTERATION

Ersatzteilliste Spare Parts List

3 / 2002

GRUNDIG

TV

CHASSIS-FS-STEREO CUC 2121 INL DOLBY CHASSIS TV STEREO CUC 2121 INL DOLBY

MATERIAL-NR. / PART NO.: 297040136000

POS. NR. POS. NO.	ABB. FIG.	MATERIAL-NR. PART NUMBER	ANZ. QTY.	BEZEICHNUNG (D)	DESCRIPTION (GB)
		297040136000		CHASSIS-FS-STEREO CUC 2121 INL DOLBY KEIN E-TEIL	CHASSIS TV STEREO CUC 2121 INL DOLBY NO SPARE PART
0100.000		295045010100		TUNER-PLL STEHEND	TUNER-PLL TOP ENTRY
0215.000		297033571100		TASTSCHALTER PROGRAMM +	KEY SWITCH PROGRAMME +
0215.000		297033571100		TASTSCHALTER PROGRAMM -	KEY SWITCH PROGRAMME -
0215.000		297033571100		TASTSCHALTER LAUTSTAERKE +	KEY SWITCH VOLUME +
0215.000		297033571100		TASTSCHALTER LAUTSTAERKE -	KEY SWITCH VOLUME -
0240.000		293033904200		KOPFHUERERBUCHSE 3,5mm O.SCHALTER	HEADPHONE SOCKET 3,5mm W/O SWITCH
0241.000		293031680503		CINCH-BUCHSE 3-FACH FBAS/NF L,R	CINCH SOCKET 3 FOLD FBAS/AF L,R
0247.000		293031190603		EURO-AV BUCHSENLEISTE 21-POL SW	EURO-AV SOCKET STRIP 21 PIN BLACK
0312.000		297006430104		ABDECKUNG EURO-AV	COVER EURO AV
0500.000		295041028300	X	BAUSTEIN STEREO	MODULE STEREO
0910.000	△	292107030100		FOKUSLEITUNG	FOCUSING CABLE
1000.000	△	096211130206	2	SICHERUNGSHALTER Si62501	FUSE HOLDER Si62501
2000.000	△	297033910600		NETZSCHALTER O.WISCHER	POWER SWITCH W/O WIPER
2200.000	△	293033995100		NETZ EINBAUGERAETESTECKER	APPLIANCE COUPLER
2400.000		293031530107		MONTAGECLIP IC40550	MOUNTING CLIP IC40550
2410.000		293031530208	2	MONTAGECLIP IC50010/T53001	MOUNTING CLIP IC50010/T53001
2440.000		293031531600		MONTAGECLIP T60506	MOUNTING CLIP T60506
2445.000		293031531605	3	MONTAGECLIP IC61040/61050/61060	MOUNTING CLIP IC61040/61050/61060
2470.000		293031562000	4	FOLIE WAERMELEITEND IC61040/ 61050/61060/T60506	FOIL HEAT CONDUCTING IC61040/ 61050/61060/T60506
				X = SIEHE GESONDERTE E-LISTE WW. = WAHLWEISE	X = SEE SEPARATE PARTS LIST WW. = OPTIONAL

POS. NR. POS. NO.	MATERIAL-NR. PART NUMBER	BEZEICHNUNG DESCRIPTION	POS. NR. POS. NO.	MATERIAL-NR. PART NUMBER	BEZEICHNUNG DESCRIPTION
C 34026	845296706400	ELKO 1000UF +50-20% 10V	CD 80501	830940159200	SMD DIODE BA591
C 40557	845299610700	ELKO 2200UF 20% 16V	CIC 80910	830581409400	SMD IC MC14094BD
C 50047	845299618700	ELKO 1000UF 20% 35V	CIC 80930	830595012900	SMD IC ST92R195C9Q1
C 50048	845299664700	ELKO 1000UF 20% 25V	CIC 82501	830596000800	SMD IC M24C08CM1TR
C 53002	851591111400	FOKO KF #35 9000PF 3,5% 1500V	CL 40511	810498233100	SMD DAEMPF-PERLE 0805 BLM SMD DAMPING BEAD
C 54011	865006704600	KERKO HV C 100PF 20% 1KV	CT 32124	830100385800	SMD TRANS BC858B/BC857B
C 54012	845299618700	ELKO 1000UF 20% 35V	CT 34031	830100385800	SMD TRANS BC858B/BC857B
C 60501	865008112500	KERKO HV C 1000PF 20% 1KV	CT 40581	830100385800	SMD TRANS BC858B/BC857B
C 60509	851591104500	FOKO FKP1 680PF 10% 1600V	CT 43010	830100385800	SMD TRANS BC858B/BC857B
C 60512	865008111100	KERKO HV C 270PF 20% 2KV	CT 43015	830100484800	SMD TRANS BC848B/BC847B
C 60523	865008112500	KERKO HV C 1000PF 20% 1KV	CT 50005	830100484800	SMD TRANS BC848B/BC847B
C 60524	865008112500	KERKO HV C 1000PF 20% 1KV	CT 50015	830100484800	SMD TRANS BC848B/BC847B
C 60526	865008112500	KERKO HV C 1000PF 20% 1KV	CT 50040	830100484800	SMD TRANS BC848B/BC847B
C 60527	865008112500	KERKO HV C 1000PF 20% 1KV	CT 50050	830100484800	SMD TRANS BC848B/BC847B
C 61016	851591104000	FOKO FKP1 220PF 10% 1600V	CT 50055	830100484800	SMD TRANS BC848B/BC847B
C 61036	865006704600	KERKO HV C 100PF 20% 1KV	CT 52260	830100385800	SMD TRANS BC858B/BC857B
C 61056	865006704600	KERKO HV C 100PF 20% 1KV	CT 57020	830100385800	SMD TRANS BC858B/BC857B
C 62501 △	851179301800	FOKO MP3 0,1UF 20% 275V	CT 57021	830100385800	SMD TRANS BC858B/BC857B
C 62521 △	866009623800	KERKO SI 2200PF 20% 400V			
C 62522 △	866009623800	KERKO SI 2200PF 20% 400V			
C 62549 △	866009623400	KERKO SI 1000PF 20% 400V			
C 81063	814054010400	EMIFIL 0,1 UF -GR			

ÄNDERUNGEN VORBEHALTEN / SUBJECT TO ALTERATION

POS. NR. POS. NO.	MATERIAL-NR. PART NUMBER	BEZEICHNUNG DESCRIPTION	POS. NR. POS. NO.	MATERIAL-NR. PART NUMBER	BEZEICHNUNG DESCRIPTION
CT 57112	830100385800	SMD TRANS BC858B/BC857B	L 61038	810498200300	FERRITPERLE BL02RN2-R62 FERRITE BEAD
CT 57113	830100385800	SMD TRANS BC858B/BC857B	L 62501 △	295008269700	FUNKENTSTOERDROSSEL INTERFERENCE CHOKE
CT 57124	830100484800	SMD TRANS BC848B/BC847B	L 81061	810498205100	FERRITPERLE HF55 BTL 3,5X FERRITE BEAD
CT 61043	830100484800	SMD TRANS BC848B/BC847B	L 81062	814052636100	DR 0411 10UH 5%
CT 61053	830100484800	SMD TRANS BC848B/BC847B	L 81064	814052636100	DR 0411 10UH 5% CHOKE
CT 81220	830100484800	SMD TRANS BC848B/BC847B	Q 34043	838212104400	QUARZ 4,433619MHZ
CT 81225	830100484800	SMD TRANS BC848B/BC847B	Q 80001	838208004000	QUARZ 4MHZ
CT 85502	830100385800	SMD TRANS BC858B/BC857B	Q 80951	838216204100	QUARZ 4MHZ
D 40584	830921504500	DIODE 1N4148	R 40551	873229240700	DRW 4 1,8 OHM 10%
D 40586	830921504500	DIODE 1N4148	R 43006	870001124600	KSW 0204 75 OHM 5%
D 43055	830921504500	DIODE 1N4148	R 50047	876642460200	MSW 0207 1,1 OHM 1%
D 43056	830921504500	DIODE 1N4148	R 50048	870552103300	MOW 0411 2,2 OHM 5%
D 50023	830921502000	DIODE 1N4004	R 50050 △	870522705300	MOW 0411 150 OHM 5%
D 50048	830970301400	Z-DIODE ZPY5,6 2%	R 52004 △	870552105300	MOW 0411 150 OHM 5%
D 52001	830921504500	DIODE 1N4148	R 53002 △	870042909700	KSW NB 0207 10 KOHM 5%
D 53003	830920100500	DIODE BA157	R 53009	871033814500	MGW AX 1 MOHM 5%
D 54001	830920426800	DIODE BYV16	R 53011 △	870552102100	MOW 0411 6,8 OHM 5%
D 54011	830920100500	DIODE BA157	R 53016	873018942500	DRW 9 10 OHM 10%
D 54022	830972033000	Z-DIODE 30X0,5W	R 53021 △	870522707100	MOW 0411 820 OHM 5%
D 57013	830921504500	DIODE 1N4148	R 53033 △	870552098500	MOW 0411 0,22 OHM 5%
D 57023	830921504500	DIODE 1N4148	R 53074 △	870556107100	MOW 0617 2,2 OHM 5%
D 60506 △	830951685400	DIODE BYT54M	R 54001 △	870552102500	MOW 0411 10 OHM 5%
D 60509 △	830966318000	Z-DIODE BZT03D180	R 54006 △	870552100900	MOW 0411 2,2 OHM 5%
D 60512	830951675400	DIODE BYT53B	R 54022 △	870556111100	MOW 0617 39 KOHM 5%
D 60523	830856038400	GLR.SKB380C1500	R 60502	870006935600	KSW 0617 3 MOHM 2%
D 61016 △	830951717800	DIODE BYW178	R 60504	870006934700	KSW 0617 1,2 MOHM 2%
D 61036 △	830951710800	DIODE BYT108-400	R 60508 △	870556110500	MOW 0617 22 KOHM 5%
D 61056 △	830951717200	DIODE BYW172D	R 60509 △	870556110500	MOW 0617 22 KOHM 5%
D 85001	830996610000	LE-DIODE TLDR4100	R 60516	879005004600	ESTR.SK10-A 4,7 KOHM LIN
F 32109	860275652100	KERTRAP #521 5,5MHZ	R 61018 △	870552111900	MOW 0411 82 KOHM 5%
F 32410	814110760100	SPULE 7X7 #601 SIGN107601	R 62501 △	831120001800	PTC DUO B59709-T60-A110
F 32412	831900198400	OFFWFL G1985M	R 62502	831100501700	NTC 4,7 OHM 30%
F 34052	814111675000	FILTER 7X7 #750 SIGN11675	R 62549 △	876504916100	MSW SI 0414 4,7 MOHM
IC 34015	830512524600	IC STV2246	SI 40551 △	831561902800	SI LOET T1 6A 250V
IC 40550	830534726600	IC TDA7266B	SI 62501 △	831561700600	SI 5X20 T2,5A L 250V
IC 50010	830533817500	IC TDA8174AW	T 52001	830328563700	TRANS BC637
IC 60510	830533464600	IC TDA16846	T 53001	830290002000	TRANS S2055N
IC 61040	830520431700	IC LM317T	T 60506	830280504000	TRANS IRFB4C40
IC 61050	830520431700	IC LM317T	TR 52001	092468680400	TRAFO TREIBER TRANSFORMER DRIVER
IC 61060	830520570300	IC MC7805CT	TR53010 △	292210315700	TRAFO DIODEN-SPLIT TRAFO DIODEN-SPLIT
IC 80500	830521006500	IC MC33164P-5RP	WW. △	292016651101	TRANSFORMER DIODE SPLIT
IC 80920	297980310100	IC 27C020 PROG.KPL	TR 61000 △	292015219703	SPERRWANDLERTRAFO B.O.TYPE CONVERTER TRANSFORMER
IC 81500	293052194100	PROZESSORPLATTE			
WW.	830415512200	IC ST92195C9B1-S242			
IC 84501	830546133000	IC TSOP1330	L 31043	814052644000	DR ST 0411-GRP 8,2UH 10%
L 31043	814052644000	DR ST 0411-GRP 8,2UH 10%	L 32023	814052653000	DR 0411 33UH 10%
L 32023	814052653000	DR 0411 33UH 10%	L 32026	814052653000	DR 0411 33UH 10%
L 32026	814052653000	DR 0411 33UH 10%	L 32109	814052690600	DR 0309 4,7UH 10%
L 32109	814052690600	DR 0309 4,7UH 10%	L 40512	814050525900	DR A AX-GA 27UH 10%
L 40512	814050525900	DR A AX-GA 27UH 10%	L 52251	814051174900	DR AX 0411-GA 10UH 10%
L 52251	814051174900	DR AX 0411-GA 10UH 10%	L 52256	814052632000	DR AX 0411-GA 3,3UH 10% CHOKE
L 52256	814052632000	DR AX 0411-GA 3,3UH 10% CHOKE	L 53003	810498205600	FERRITPERLE HF70 BTL 3,5X FERRITE BEAD
L 53003	810498205600	FERRITPERLE HF70 BTL 3,5X FERRITE BEAD	L 53011	814050524900	DR A AX-GA 10UH 10% CHOKE
L 53011	814050524900	DR A AX-GA 10UH 10% CHOKE	L 53021	292031149500	LINEARITAETSREGLER LINEARITY CONTROL
L 53021	292031149500	LINEARITAETSREGLER LINEARITY CONTROL	L 53074	092468700101	ZB-SPULE ZB COIL
L 53074	092468700101	ZB-SPULE ZB COIL	L 60506	810498205700	FERRITPERLE 3,6UH 5720500

Es gelten die Vorschriften und Sicherheitshinweise gemäß dem Service Manual "Sicherheit", Mat.-Nummer 720108000000, sowie zusätzlich die eventuell abweichenden, landesspezifischen Vorschriften!



The regulations and safety instructions shall be valid as provided by the "Safety" Service Manual, part number 720108000000, as well as the respective national deviations.

ÄNDERUNGEN VORBEHALTEN / SUBJECT TO ALTERATION

Ersatzteilliste
Spare Parts List

3 / 2002

CHASSIS-FS-STEREO CUC 2121 INL DOLBY
CHASSIS TV STEREO CUC 2121 INL DOLBY

MATERIAL-NR. / PART NO.: 297040136100

POS. NR. POS. NO.	ABB. FIG.	MATERIAL-NR. PART NUMBER	ANZ. QTY.	BEZEICHNUNG (D)	DESCRIPTION (GB)
		297040136100		CHASSIS-FS-STEREO CUC 2121 INL DOLBY KEIN E-TEIL	CHASSIS TV STEREO CUC 2121 INL DOLBY NO SPARE PART
0100.000		295045010100		TUNER-PLL STEHEND	TUNER-PLL TOP ENTRY
0215.000		297033571100		TASTSCHALTER PROGRAMM +	KEY SWITCH PROGRAMME +
0215.000		297033571100		TASTSCHALTER PROGRAMM -	KEY SWITCH PROGRAMME -
0215.000		297033571100		TASTSCHALTER LAUTSTAERKE +	KEY SWITCH VOLUME +
0215.000		297033571100		TASTSCHALTER LAUTSTAERKE -	KEY SWITCH VOLUME -
0240.000		293033904200		KOPFHOERERBUCHSE 3,5mm O.SCHALTER	HEADPHONE SOCKET 3,5mm W/O SWITCH
0241.000		293031680503		CINCH-BUCHSE 3-FACH FBAS/NF L,R	CINCH SOCKET 3 FOLD FBAS/AF L,R
0247.000		293031190603		EURO-AV BUCHSENLEISTE 21-POL SW	EURO-AV SOCKET STRIP 21 PIN BLACK
0312.000		297006430104		ABDECKUNG EURO-AV	COVER EURO AV
0500.000		295041028300	X	BAUSTEIN STEREO	MODULE STEREO
0910.000	△	292107030100		FOKUSLEITUNG	FOCUSING CABLE
1000.000	△	096211130206	2	SICHERUNGSHALTER SI62501	FUSE HOLDER SI62501
2000.000	△	297033910600		NETZSCHALTER O.WISCHER	POWER SWITCH W/O WIPER
2200.000	△	293033995100		NETZ EINBAUGERAETESTECKER	APPLIANCE COUPLER
2400.000		293031530107		MONTAGECLIP IC40550	MOUNTING CLIP IC40550
2410.000		293031530208	2	MONTAGECLIP IC50010/T53001	MOUNTING CLIP IC50010/T53001
2440.000		293031531600		MONTAGECLIP T60506	MOUNTING CLIP T60506
2445.000		293031531605	3	MONTAGECLIP IC61040/61050/61060	MOUNTING CLIP IC61040/61050/61060
2470.000		293031562000	4	FOLIE WAERMELEITEND IC61040/ 61050/61060/T60506	FOIL HEAT CONDUCTING IC61040/ 61050/61060/T60506
				X = SIEHE GESONDERTE E-LISTE WW. = WAHLWEISE	X = SEE SEPARATE PARTS LIST WW. = OPTIONAL

POS. NR. POS. NO.	MATERIAL-NR. PART NUMBER	BEZEICHNUNG DESCRIPTION	POS. NR. POS. NO.	MATERIAL-NR. PART NUMBER	BEZEICHNUNG DESCRIPTION
C 34026	845296706400	ELKO 1000UF +50-20% 10V	CD 80501	830940159200	SMD DIODE BA591
C 40557	845299610700	ELKO 2200UF 20% 16V	CIC 80910	830581409400	SMD IC MC14094BD
C 50047	845299618700	ELKO 1000UF 20% 35V	CIC 80930	830595012900	SMD IC ST92R195C901
C 50048	845299864700	ELKO 1000UF 20% 25V	CIC 82501	830596000800	SMD IC M24C08CM1TR
C 53002	851591110200	FOKO FKP1/4 8500PF 3,5% 1500V			
C 54011	865006704600	KERKO HV C 100PF 20% 1KV	CL 40511	810498233100	SMD DAEMPF-PERLE 0805 BLM SMD DAMPING BEAD
C 54012	845299618700	ELKO 1000UF 20% 35V			
C 60501	865008112500	KERKO HV C 1000PF 20% 1KV	CT 32124	830100385800	SMD TRANS BC858B/BC857B
C 60509	851591104500	FOKO FKP1 680PF 10% 1600V	CT 34031	830100385800	SMD TRANS BC858B/BC857B
C 60512	865008111100	KERKO HV C 270PF 20% 2KV	CT 40581	830100385800	SMD TRANS BC858B/BC857B
C 60523	865008112500	KERKO HV C 1000PF 20% 1KV	CT 43010	830100385800	SMD TRANS BC858B/BC857B
C 60524	865008112500	KERKO HV C 1000PF 20% 1KV	CT 43015	830100484800	SMD TRANS BC848B/BC847B
C 60526	865008112500	KERKO HV C 1000PF 20% 1KV	CT 50005	830100484800	SMD TRANS BC848B/BC847B
C 60527	865008112500	KERKO HV C 1000PF 20% 1KV	CT 50015	830100484800	SMD TRANS BC848B/BC847B
C 61016	851591104000	FOKO FKP1 220PF 10% 1600V	CT 50040	830100484800	SMD TRANS BC848B/BC847B
C 61036	865006704600	KERKO HV C 100PF 20% 1KV	CT 50050	830100484800	SMD TRANS BC848B/BC847B
C 61056	865006704600	KERKO HV C 100PF 20% 1KV	CT 50055	830100484800	SMD TRANS BC848B/BC847B
C 62501 △	851179301800	FOKO MP3 0,1UF 20% 275V	CT 52260	830100385800	SMD TRANS BC858B/BC857B
C 62521 △	866009623800	KERKO SI 2200PF 20% 400V	CT 52265	830100385800	SMD TRANS BC858B/BC857B
C 62522 △	866009623800	KERKO SI 2200PF 20% 400V	CT 57020	830100385800	SMD TRANS BC858B/BC857B
C 62549 △	866009623400	KERKO SI 1000PF 20% 400V	CT 57021	830100385800	SMD TRANS BC858B/BC857B
C 81063	814054010400	EMIFIL 0,1 UF -GR			

ÄNDERUNGEN VORBEHALTEN / SUBJECT TO ALTERATION

POS. NR. POS. NO.	MATERIAL-NR. PART NUMBER	BEZEICHNUNG DESCRIPTION	POS. NR. POS. NO.	MATERIAL-NR. PART NUMBER	BEZEICHNUNG DESCRIPTION
CT 57112	830100385800	SMD TRANS BC858B/BC857B	L 61038	810498200300	FERRITPERLE BL02RN2-R62
CT 57113	830100385800	SMD TRANS BC858B/BC857B			FERRITE BEAD
CT 57124	830100484800	SMD TRANS BC848B/BC847B	L 62501 △	295008269700	FUNKENTSTOERDROSSEL INTERFERENCE CHOKE
CT 61043	830100484800	SMD TRANS BC848B/BC847B			
CT 61053	830100484800	SMD TRANS BC848B/BC847B	L 81061	810498205100	FERRITPERLE HF55 BTL 3,5X
CT 81220	830100484800	SMD TRANS BC848B/BC847B			FERRITE BEAD
CT 81225	830100484800	SMD TRANS BC848B/BC847B	L 81062	814052636100	DR 0411 10UH 5%
CT 85502	830100385800	SMD TRANS BC858B/BC857B	L 81064	814052636100	DR 0411 10UH 5% CHOK
D 40584	830921504500	DIODE 1N4148	Q 34043	838212104400	QUARZ 4.433619MHZ
D 40586	830921504500	DIODE 1N4148	Q 80001	838208004000	QUARZ 4MHZ
D 43055	830921504500	DIODE 1N4148	Q 80951	838216204100	QUARZ 4MHZ
D 43056	830921504500	DIODE 1N4148			
D 50023	830921502000	DIODE 1N4004	R 40551	873229240700	DRW 4 1,8 OHM 10%
D 50048	830970301400	Z-DIODE ZPY5,6 2%	R 43006	870001124600	KSW 0204 75 OHM 5%
D 52001	830921504500	DIODE 1N4148	R 50047	876642460200	MSW 0207 1,1 OHM 1%
D 53003	830920100500	DIODE BA157	R 50048 △	870552103300	MOW 0411 22 OHM 5%
D 54001	830920426800	DIODE BYV16	R 50050 △	870522705300	MOW 0411 150 OHM 5%
D 54011	830920100500	DIODE BA157	R 52004 △	870552105300	MOW 0411 150 OHM 5%
D 54022	830927033000	Z-DIODE 30B 0,5W	R 53002 △	870042909700	KSW NB 0207 10 KOHM 5%
D 57013	830921504500	DIODE 1N4148	R 53009	871033814500	MGW AX 1 MOHM 5%
D 57023	830921504500	DIODE 1N4148	R 53011 △	870552102100	MOW 0411 6,8 OHM 5%
D 60506 △	830951685400	DIODE BYT54M	R 53016	873018942500	DRW 9 10 OHM 10%
D 60509 △	830966318000	Z-DIODE BZT03D180	R 53021 △	870522707100	MOW 0411 820 OHM 5%
D 60512	830951675400	DIODE BYT53B	R 53033 △	870552098500	MOW 0411 0,22 OHM 5%
D 60523	830856038400	GLR,SKB380C1500	R 53074 △	870556107100	MOW 0617 820 OHM 5%
D 61016 △	830951717800	DIODE BYW178	R 54001 △	870552102500	MOW 0411 10 OHM 5%
D 61036 △	830951710800	DIODE BYT108-400	R 54006 △	870552100900	MOW 0411 2,2 OHM 5%
D 61056 △	830951717200	DIODE BYW172	R 54022 △	870556111100	MOW 0617 39 KOHM 5%
D 85001	830996610000	LE-DIODE TLDR4100	R 60502	870006935600	KSW 0617 3 MOHM 2%
F 32109	860275652100	KERTRAP #521 5,5MHZ	R 60504	870006934700	KSW 0617 1,2 MOHM 2%
F 32410	814110760100	SPLULE 7X7 #601 SIGN107601	R 60508 △	870556110500	MOW 0617 22 KOHM 5%
F 32412	831900198400	OFWFL G1985M	R 60509 △	870556110500	MOW 0617 22 KOHM 5%
F 34052	814111675000	FILTER 7X7 #750 SIGN11675	R 60516	879005004600	ESTR.SK10-A 4,7 KOHM LIN
IC 34015	830512524600	IC STV2246	R 61018 △	870552111900	MOW 0411 82 KOHM 5%
IC 40550	830534726600	IC TDA7266B	R 62501 △	831120001800	PTC DUO B59709-T60-A110
IC 50010	830533817500	IC TDA8174AW	R 62502	831100501700	NTC 4,7 OHM 30%
IC 60510	830533464600	IC TDA16846	R 62549 △	876504916100	MSW SI 0414 4,7 MOHM
IC 61040	830520431700	IC LM317T	SI 40551 △	831561902800	SI LOET T1,6A 250V
IC 61050	830520431700	IC LM317T	SI 62501 △	831561700600	SI 5X20 T2,5A 1250V
IC 61060	830520570300	IC MC7805CT	T 52001	830328563700	TRANS BC637
IC 80500	830521006500	IC MC33164P-5RP	T 53001	830290002000	TRANS S2055N
IC 80920	297980310100	IC 27C020 PROG.KPL	T 60506	830280504000	TRANS IRFBC40
IC 81500	293052194100	PROZESSORPLATTE			
WW.	830415512200	IC ST92195C9B1-S242			
IC 84501	830546133000	IC TSOP1330	TR 52001	092468680400	TRAFO TREIBER TRANSFORMER DRIVER
L 31043	814052644000	DR ST 0411-GRP 8,2UH 10%	TR53010 △	292210315700	TRAFO DIODEN-SPLIT
L 32023	814052653000	DR 0411 33UH 10%	WW. △	292016651101	TRAFO DIODEN-SPLIT
L 32026	814052653000	DR 0411 33UH 10%			TRANSFORMER DIODE SPLIT
L 32109	814052690600	DR 0309 4,7UH 10%	TR 61000 △	292015219703	SPERRWANDLERTRAFO B.O.TYPE CONVERTER TRANSFORMER
L 40512	814050525900	DR A AX-GA 27UH 10%			
L 52251	814051174900	DR AX 0411-GA 10UH 10%			
L 52256	814052632000	DR AX 0411-GA 3,3UH 10% CHOK			
L 53003	810498205600	FERRITPERLE HF70 BTL 3,5X FERRITE BEAD			
L 53011	814050524900	DR A AX-GA 10UH 10% CHOK			
L 53021	292031149500	LINEARITAETSREGLER LINEARITY CONTROL			
L 53074	092468700101	ZB-SPLULE ZB COIL			
L 60506	810498205700	FERRITPERLE 3,6UH 5720500			

Es gelten die Vorschriften und Sicherheitshinweise gemäß dem Service Manual "Sicherheit", Mat.-Nummer 720108000000, sowie zusätzlich die eventuell abweichenden, landesspezifischen Vorschriften!



The regulations and safety instructions shall be valid as provided by the "Safety" Service Manual, part number 720108000000, as well as the respective national deviations.

ÄNDERUNGEN VORBEHALTEN / SUBJECT TO ALTERATION

Ersatzteilliste
Spare Parts List

1 / 2002

CHASSIS-FS-STEREO CUC 2121 MUL/DOLBY
CHASSIS TV STEREO CUC 2121 MUL/DOLBY

MATERIAL-NR. / PART NO.: 297040136200

Table with 4 columns: POS. NR./POS. NO., ABB./FIG., MATERIAL-NR./PART NUMBER, ANZ./QTY., BEZEICHNUNG/DESCRIPTION.

Main parts list table containing various electronic components like capacitors, diodes, and transistors.

WW.=WAHLWEISE X = SIEHE GESONDERTE E-LISTE WW.=OPTIONAL X = SEE SEPARATE PARTS LIST

Table with 4 columns: POS. NR./POS. NO., MATERIAL-NR./PART NUMBER, BEZEICHNUNG/DESCRIPTION.

ÄNDERUNGEN VORBEHALTEN / SUBJECT TO ALTERATION

Table with 3 columns: POS. NR./POS. NO., MATERIAL-NR./PART NUMBER, BEZEICHNUNG/DESCRIPTION.

Es gelten die Vorschriften und Sicherheitshinweise gemäß dem Service Manual "Sicherheit", Mat.-Nummer 720108000000, sowie zusätzlich die eventuell abweichenden, landesspezifischen Vorschriften!

Table with 3 columns: POS. NR./POS. NO., MATERIAL-NR./PART NUMBER, BEZEICHNUNG/DESCRIPTION.



The regulations and safety instructions shall be valid as provided by the "Safety" Service Manual, part number 720108000000, as well as the respective national deviations.

ÄNDERUNGEN VORBEHALTEN / SUBJECT TO ALTERATION

Ersatzteilliste
Spare Parts List

1 / 2002

CHASSIS-FS-STEREO CUC 2121 MUL/DOLBY
CHASSIS-FS-STEREO CUC 2121 MUL/DOLBY

MATERIAL-NR. / PART NO.: 297040136300

POS. NR. POS. NO.	ABB. FIG.	MATERIAL-NR. PART NUMBER	ANZ. QTY.	BEZEICHNUNG ①	DESCRIPTION ②
		297040136300		CHASSIS-FS-STEREO CUC 2121 MUL/DOLBY KEIN E-TEIL	CHASSIS TV STEREO CUC 2121 MUL/DOLBY NO SPARE PART
0100.000		295045010100		TUNER-PLL STEHEND	TUNER-PLL TOP ENTRY
0216.000		297033571100		TASTSCHALTER PROGRAMM+	KEY SWITCH PROGRAMME+
0216.000		297033571100		TASTSCHALTER PROGRAMM-	KEY SWITCH PROGRAMME-
0216.000		297033571100		TASTSCHALTER LAUTSTAERKE+	KEY SWITCH VOLUME+
0216.000		297033571100		TASTSCHALTER LAUTSTAERKE-	KEY SWITCH VOLUME-
0240.000		293033904200		KOPFHÖRERBUCHSE 3,5 O.SCHALTER	HEADPHONE SOCKET 3,5 W/O SWITCH
0241.000		293031180503		CINCH-BUCHSE 3-FACH FBAS/NF L,R	CINCH SOCKET 3 FOLD FBAS/AF L,R
0247.000		293031190603		EURO-AV BUCHSENLEISTE 21-POL SW	EURO-AV SOCKET STRIP 21 P BLACK
0312.000		297006430104		ABDECKUNG EURO-AV	COVER EURO AV
0500.000		295041028400	X	BAUSTEIN STEREO MODUL	STEREO MODULE
0910.000	△	292107030100		FOKUSLEITUNG	FOCUSING CABLE
1000.000	△	096211130206	2	SICHERUNGSHALTER SI62501	FUSE HOLDER SI62501
2000.000	△	297033910600		NETZSCHALTER O.WISCHER	POWER SWITCH W/O WIPER
2200.000	△	293033995100		NETZ EINBAUGERAETESTECKER	APPLIANCE COUPLER W.CABLE
2400.000		293031530107		MONTAGECLIP IC40550	MOUNTING CLIP IC40550
2410.000		293031530208	2	MONTAGECLIP IC50010/T53001	MOUNTING CLIP IC50010/T53001
2420.000		293031531600		MONTAGECLIP T60506	MOUNTING CLIP T60506
2430.000		293031531605	3	MONTAGECLIP IC61040/61050/61060	MOUNTING CLIP IC61040/61050/61060
2450.000		293031562000	4	FOLIE WÄRMELEITEND IC61040/61050/61060/T60506	FOIL HEAT CONDUCTING IC61040/61050/61060/T60506
				WW.=WAHLWEISE X=SIEHE GESONDERTE E-LISTE	WW.=OPTIONAL X=SEE SEPARATE PARTS LIST

POS. NR. POS. NO.	MATERIAL-NR. PART NUMBER	BEZEICHNUNG DESCRIPTION	POS. NR. POS. NO.	MATERIAL-NR. PART NUMBER	BEZEICHNUNG DESCRIPTION
C 34026	845296706400	ELKO 1000UF +50-20% 10V	C 81063	814054010400	EMIFIL 0,1 UF
C 40557	845299610700	ELKO 2200UF 20% 16V	CD 32411	830940159200	SMD DIODE BA591/BA592/BA782S
C 50047	845299618700	ELKO 1000UF 20% 35V	CD 32460	830940159200	SMD DIODE BA591/BA592/BA782S
C 50048	845299864700	ELKO 1000UF 20% 25V	CD 32470	830940159200	SMD DIODE BA591/BA592/BA782S
C 53002	851591111400	FOKO KF #35 9000PF 3,5% 1500V	CD 34041	830940159200	SMD DIODE BA591/BA592/BA782S
C 54011	865006704600	KERKO HV C 100PF 20% 1KV	CD 80501	830940159200	SMD DIODE BA591/BA592/BA782S
C 54012	845299618700	ELKO 1000UF 20% 35V	CIC 80910	830581409400	SMD IC MC14094BD
C 60501	865008112500	KERKO HV C 1000PF 20% 1KV	CIC 80930	830595012900	SMD IC ST92R195C9Q1
C 60509	851591104500	FOKO FKP1 680PF 10% 1600V	CIC 82501	830596000800	SMD IC M24C08CM1TR
C 60512	865008111100	KERKO HV C 270PF 20% 2KV	CL 40511	810498233100	SMD DAEMPF-PERLE 0805
C 60523	865008112500	KERKO HV C 1000PF 20% 1KV	CT 32111	830100484800	SMD TRANS BC848B/ BC847B
C 60524	865008112500	KERKO HV C 1000PF 20% 1KV	CT 32122	830100385800	SMD TRANS BC858B/ BC857B
C 60526	865008112500	KERKO HV C 1000PF 20% 1KV	CT 32123	830100484800	SMD TRANS BC848B/ BC847B
C 60527	865008112500	KERKO HV C 1000PF 20% 1KV	CT 32124	830100385800	SMD TRANS BC858B/ BC857B
C 60528	845209711500	ELKO SNT #40 150UF 385V/400V	CT 32132	830100484800	SMD TRANS BC848B/ BC847B
WW.	845199711500	ELKO 19 150UF 385V	CT 32460	830100484800	SMD TRANS BC848B/ BC847B
C 61016	851591104000	FOKO FKP1 220PF 10% 1600V	CT 32470	830100484800	SMD TRANS BC848B/ BC847B
C 61036	865006704600	KERKO HV C 100PF 20% 1KV	CT 32480	830100484800	SMD TRANS BC848B/ BC847B
C 61056	865006704600	KERKO HV C 100PF 20% 1KV	CT 34031	830100385800	SMD TRANS BC858B/ BC857B
C 62501	851179301800	FOKO MP3 0,1UF 20% 275VW			
C 62521	866009623800	KERKO SI 2200PF 20%			
C 62522	866009623800	KERKO SI 2200PF 20%			
C 62549	866009623400	KERKO SI 1000PF 20%			

ÄNDERUNGEN VORBEHALTEN / SUBJECT TO ALTERATION

GRUNDIG

TV

POS. NR. POS. NO.	MATERIAL-NR. PART NUMBER	BEZEICHNUNG DESCRIPTION	POS. NR. POS. NO.	MATERIAL-NR. PART NUMBER	BEZEICHNUNG DESCRIPTION
CT 40581	830100385800	SMD TRANS BC858B/ BC857B	L 52256	814052632000	DR AX 0411-GA 3,3UH 10%
CT 43010	830100385800	SMD TRANS BC858B/ BC857B	L 53003	810498205600	FERRITPERLE HF70 BTL 3,5X6 FERRITE BEAD
CT 43015	830100484800	SMD TRANS BC848B/ BC847B	L 53011	814050524900	DR A AX-GA 10UH 10%
CT 50005	830100484800	SMD TRANS BC848B/ BC847B	L 53021	292031149500	LINEARITÄTSREGLER
CT 50015	830100484800	SMD TRANS BC848B/ BC847B			
CT 50040	830100484800	SMD TRANS BC848B/ BC847B	L 53074	092468700101	ZB-SPULE/ZB COIL
CT 50050	830100484800	SMD TRANS BC848B/ BC847B	L 60506	810498205700	FERRITPERLE 3,6UH
CT 50055	830100484800	SMD TRANS BC848B/ BC847B	L 61038	810498200300	FERRITPERLE BL02RN2-R62 FERRITE BEAD
CT 52260	830100385800	SMD TRANS BC858B/ BC857B	L 62501	295008269700	FUNKENTSTÖRERDROSSEL RK19 INTERFERENCE SUPPR. CHOKE
CT 57020	830100385800	SMD TRANS BC858B/ BC857B	L 81061	810498205100	FERRITPERLE HF55 BTL 3,5X4,5 FERRITE BEAD
CT 57021	830100385800	SMD TRANS BC858B/ BC857B	L 81062	814052636100	DR 0411 10UH 5%
CT 57112	830100385800	SMD TRANS BC858B/ BC857B	L 81064	814052636100	DR 0411 10UH 5%
CT 57113	830100385800	SMD TRANS BC858B/ BC857B			
CT 57124	830100484800	SMD TRANS BC848B/ BC847B			
CT 61043	830100484800	SMD TRANS BC848B/ BC847B	Q 34043	838212104400	QUARZ 4,433619 MHZ
CT 61053	830100484800	SMD TRANS BC848B/ BC847B	Q 34044	838204900300	QUARZ 3,579545MHZ
CT 81220	830100484800	SMD TRANS BC848B/ BC847B	Q 80001	838208004000	QUARZ 4 MHZ
CT 81225	830100484800	SMD TRANS BC848B/ BC847B	Q 80951	838216204100	QUARZ 4 MHZ
CT 85502	830100385800	SMD TRANS BC858B/ BC857B			
D 40584	830921504500	DIODE 1N4148	R 40551	873229240700	DRW 4 1,8 OHM 10%
D 40586	830921504500	DIODE 1N4148	R 43006	870001124600	KSW 0204 75 OHM 5%
D 43055	830921504500	DIODE 1N4148	R 50047	876642460200	MSW 0207 1,1 OHM 1% ST
D 43056	830921504500	DIODE 1N4148	R 50048	870552103300	MOW 0411 22 OHM 5% LI
D 50023	830921502000	DIODE 1N4A04	R 50050	870522705300	MOW 0411 150 OHM 5% LI
D 50048	830970301400	Z-DIODE ZPZY5,6 2%	R 52004	870552105300	MOW 0411 150 OHM 5% LI
D 52001	830921504500	DIODE 1N4148	R 53002	870042909700	KSW NB 0207 10 KOHM 5% ST
D 53003	830920100500	DIODE BA157	R 53009	871033814500	MGW AX 1 MOHM 5%
D 54001	830920426800	DIODE BYV16	R 53011	870552102100	MOW 0411 6,8 OHM 5% LI
D 54011	830920100500	DIODE BA157	R 53016	873018942500	DRW 9 10 OHM 10%
D 54022	830927033000	Z-DIODE 30 B 0,5W	R 53021	870522707100	MOW 0411 820 OHM 5%
D 57013	830921504500	DIODE 1N4148	R 53033	870552100500	MOW 0411 1,5 OHM 5% LI
D 57023	830921504500	DIODE 1N4148	R 53074	870556107100	MOW 0617 820 OHM 5% LI
D 60506	830951685400	DIODE BYT 54 M	R 54001	870552102500	MOW 0411 10 OHM 5% LI
D 60509	830966318000	Z-DIODE BZT03D180	R 54006	870552100900	MOW 0411 2,2 OHM 5% LI
D 60512	830951675400	DIODE BYT53B	R 54022	870556111100	MOW 0617 39 KOHM 5% LI
D 60523	830856038400	GLR.SKB380C1500	R 60502	870006934700	KSW 0617 3 MOHM 2%
D 61016	830951717800	DIODE BYW178	R 60504	870006934700	KSW 0617 1,2 MOHM 2%
D 61037	830951710800	DIODE BYT108-400	R 60508	870556110500	MOW 0617 22 KOHM 5% LI
D 61056	830951717200	DIODE BYW172D	R 60509	870556110500	MOW 0617 22 KOHM 5% LI
D 85511	830994460100	LE DIODE TLHR 4601	R 60516	879005004600	ESTR.SK10-A 4,7 KOHM LIN
F 32109	860275506600	KERTRAP #66 5,5/6/6,5MHZ	R 61018	870552111900	MOW 0411 82 KOHM 5% LI
F 32121	814111136000	FILTER 7X7 360	R 62501	831120001600	PTC DUO T251-A80-A10
F 32410	814053445100	SPULE 7X7 #451	R 62502	831100501700	NTC 4,7 OHM 30%
F 32412	831900395300	OFWFL K3953M	R 62549	876504916100	MSW SI 0414 4,7 MOHM VDE
F 32430	831900465400	OFWFL K4654K	SI 40551	831561902800	SI LOET T1,6A 250V
F 34052	814111675000	FILTER 7X7 #750	SI 62501	831561700600	SI 5X20 T2,5A L 250V
IC 34015	830512524800	IC STV2248	T 52001	830328563700	TRANS.BC 637
IC 40550	830534726600	IC TDA7266B	T 53001	830290002000	TRANS.S2055N BU508DF
IC 50010	830533817500	IC TDA8174AW	T 60506	830280504000	TRANS.IRF BC 40 IOR ZNG.2
IC 60510	830533464600	IC TDA16846	TR 52001	092468680400	TRAFO TREIBER
IC 61040	830520431700	IC LM317T	TR 53010	292210315700	DIODE DIODEN-SPLIT KPL TRAFO SPLIT TRANSFORMER CPL
IC 61050	830520431700	IC LM317T	TR 53020	292016651101	DIODEN-SPLIT TRAFO DIODE SPLIT TRANSFORMER
IC 61060	830520570300	IC MC7805CT	TR 61000	292015219703	SPERRWANDLERTRAFO REVERSE CONVERTER
IC 80500	830521006500	IC MC33164P-5RP			
IC 80920	297980320100	IC 27C020 PROG.KPL			
IC 81500	293052194200	PROZESSORPLATTE			
WW.	830415513200	IC ST92195C9B1-S252			
IC 84501	830546133000	IC TSOP1330			
L 31043	814052644000	DR ST 0411-GRP 8,2UH 10%			
L 32109	814052690600	DR 0309 4,7UH 10% ST			
L 40512	814050525900	DR A AX-GA 27UH 10%			
L 52251	814051174900	DR AX 0411-GA 10UH 10%			

Es gelten die Vorschriften und Sicherheitshinweise gemäß dem Service Manual "Sicherheit", Mat.-Nummer 720108000000, sowie zusätzlich die eventuell abweichenden, landesspezifischen Vorschriften!



The regulations and safety instructions shall be valid as provided by the "Safety" Service Manual, part number 720108000000, as well as the respective national deviations.

ÄNDERUNGEN VORBEHALTEN / SUBJECT TO ALTERATION

Ersatzteilliste Spare Parts List

1 / 2002

CHASSIS-FS-STEREO CUC 2121 MUL/DOLBY CHASSIS-FS-STEREO CUC 2121 MUL/DOLBY

MATERIAL-NR. / PART NO.: 297040136400

POS. NR. POS. NO.	ABB. FIG.	MATERIAL-NR. PART NUMBER	ANZ. QTY.	BEZEICHNUNG (D)	DESCRIPTION (GB)
		297040136400		CHASSIS-FS-STEREO CUC 2121 MUL/DOLBY KEIN E-TEIL	CHASSIS TV STEREO CUC 2121 MUL/DOLBY NO SPARE PART
0100.000		295045010100		TUNER-PLL STEHEND	TUNER-PLL TOP ENTRY
0216.000		297033571100		TASTSCHALTER PROGRAMM+	KEY SWITCH PROGRAMM+
0216.000		297033571100		TASTSCHALTER PROGRAMM-	KEY SWITCH PROGRAMM-
0216.000		297033571100		TASTSCHALTER LAUTSTAERKE+	KEY SWITCH VOLUME+
0216.000		297033571100		TASTSCHALTER LAUTSTAERKE-	KEY SWITCH VOLUME-
0240.000		293033904200		KOPFHÖRERBUCHSE 3,5 O.SCHALTER	HEADPHONE SOCKET 3,5 W/O SWITCH
0241.000		293031680503		CINCH-BUCHSE 3-FACH FBAS/NF L,R	CINCH SOCKET 3 FOLD FBAS/AF L,R
0247.000		293031190603		EURO-AV BUCHSENLEISTE 21-POL SW	EURO-AV SOCKET STRIP 21 P BLACK
0312.000		297006430104		ABDECKUNG EURO-AV	COVER EURO AV
0500.000		295041028400	X	BLAUSTEIN STEREO MODUL	STEREO MODULE
0910.000	Δ	292107030100		FOKUSLEITUNG	FOCUSING CABLE
1000.000	Δ	096211130206	2	SICHERUNGSHALTER Si62501	FUSE HOLDER Si62501
2000.000	Δ	297033910600		NETZSCHALTER O.WISCHER	POWER SWITCH W/O WIPER
2200.000	Δ	293033995100		NETZ EINBAUGERAETESTECKER	APPLIANCE COUPLER W.CABLE
2400.000		293031530107		MONTAGECLIP IC40550	MOUNTING CLIP IC40550
2410.000		293031530208	2	MONTAGECLIP IC50010/T53001	MOUNTING CLIP IC50010/T53001
2420.000		293031531600		MONTAGECLIP T60506	MOUNTING CLIP T60506
2430.000		293031531605	3	MONTAGECLIP IC61040/61050/61060	MOUNTING CLIP IC61040/61050/61060
2450.000		293031562000	4	FOLIE WAEERMELEITEND	FOIL HEAT CONDUCTING
				IC61040/61050/61060/T60506	IC61040/61050/61060/T60506
				WW.=WAHLWEISE	WW.=OPTIONAL
				X=SIEMENS GESONDERTE E-LISTE	X=SEE SEPARATE PARTS LIST

POS. NR. POS. NO.	MATERIAL-NR. PART NUMBER	BEZEICHNUNG DESCRIPTION	POS. NR. POS. NO.	MATERIAL-NR. PART NUMBER	BEZEICHNUNG DESCRIPTION
C 34026	845296706400	ELKO 1000UF +50-20% 10V	C 81063	814054010400	EMIFIL 0,1 UF
C 40557	845299610700	ELKO 2200UF 20% 16V	CD 32411	830940159200	SMD DIODE BA591/BA592/BA782S
C 50047	845299618700	ELKO 1000UF 20% 35V	CD 32460	830940159200	SMD DIODE BA591/BA592/BA782S
C 50048	845299664700	ELKO 1000UF 20% 25V	CD 32470	830940159200	SMD DIODE BA591/BA592/BA782S
C 53002	851591111400	FOKO KF #35 9000PF 3,5% 1500V	CD 34041	830940159200	SMD DIODE BA591/BA592/BA782S
C 54011	865006704600	KERKO HV C 100PF 20% 1KV	CD 80501	830940159200	SMD DIODE BA591/BA592/BA782S
C 54012	845299618700	ELKO 1000UF 20% 35V	CIC 80910	830581409400	SMD IC MC14094BD
C 60501	865008112500	KERKO HV C 1000PF 20% 1KV	CIC 80930	830595012900	SMD IC ST92R195C9Q1
C 60509	851591104500	FOKO FKP1 680PF 10% 1600V	CIC 82501	830596000800	SMD IC M24C08CM1TR
C 60512	865008111100	KERKO HV C 270PF 20% 2KV	CL 40511	810498233100	SMD DAEMPF-PERLE 0805
C 60523	865008112500	KERKO HV C 1000PF 20% 1KV	CT 32111	830100484800	SMD TRANS BC848B/ BC847B
C 60524	865008112500	KERKO HV C 1000PF 20% 1KV	CT 32122	830100385800	SMD TRANS BC858B/ BC857B
C 60526	865008112500	KERKO HV C 1000PF 20% 1KV	CT 32123	830100484800	SMD TRANS BC848B/ BC847B
C 60527	865008112500	KERKO HV C 1000PF 20% 1KV	CT 32124	830100385800	SMD TRANS BC858B/ BC857B
C 60528	845209711500	ELKO SNT #40 150UF 385V/400V	CT 32132	830100484800	SMD TRANS BC848B/ BC847B
WW.	845199711500	ELKO 19 150UF 385V	CT 32460	830100484800	SMD TRANS BC848B/ BC847B
C 61016	851591104000	FOKO FKP1 220PF 10% 1600V	CT 32470	830100484800	SMD TRANS BC848B/ BC847B
C 61036	865006704600	KERKO HV C 100PF 20% 1KV	CT 32480	830100484800	SMD TRANS BC848B/ BC847B
C 61056	865006704600	KERKO HV C 100PF 20% 1KV	CT 34031	830100385800	SMD TRANS BC858B/ BC857B
C 62501 Δ	851179301800	FOKO MP3 0,1UF 20% 275VW			
C 62521 Δ	866009623800	KERKO SI 2200PF 20%			
C 62522 Δ	866009623800	KERKO SI 2200PF 20%			
C 62549 Δ	866009623400	KERKO SI 1000PF 20%			

ÄNDERUNGEN VORBEHALTEN / SUBJECT TO ALTERATION

GRUNDIG

TV

POS. NR. POS. NO.	MATERIAL-NR. PART NUMBER	BEZEICHNUNG DESCRIPTION	POS. NR. POS. NO.	MATERIAL-NR. PART NUMBER	BEZEICHNUNG DESCRIPTION
CT 40581	830100385800	SMD TRANS BC858B/ BC857B	L 52256	814052632000	DR AX 0411-GA 3,3UH 10%
CT 43010	830100385800	SMD TRANS BC858B/ BC857B	L 53003	810498205600	FERRITPERLE HF70 BTL 3,5X6
CT 43015	830100484800	SMD TRANS BC848B/ BC847B			FERRITE BEAD
CT 50005	830100484800	SMD TRANS BC848B/ BC847B	L 53011	814050524900	DR A AX-GA 10UH 10%
CT 50015	830100484800	SMD TRANS BC848B/ BC847B	L 53021	292031149500	LINEARITAETSREGLER LINEARITY CONTROL
CT 50040	830100484800	SMD TRANS BC848B/ BC847B			ZB-SPULE/ZB COIL
CT 50050	830100484800	SMD TRANS BC848B/ BC847B	L 53074	092468700101	FERRITPERLE 3.6UH
CT 50055	830100484800	SMD TRANS BC848B/ BC847B	L 60506	810498205700	FERRITPERLE HF55 BTL 3,5X4,5
CT 52260	830100385800	SMD TRANS BC858B/ BC857B	L 61038	810498200300	FERRITPERLE BL02RN2-R62
CT 57020	830100385800	SMD TRANS BC858B/ BC857B			FERRITE BEAD
CT 57021	830100385800	SMD TRANS BC858B/ BC857B	L 62501 Δ	295008269700	FUNKENTSTOERDROSSEL RK19
CT 57112	830100385800	SMD TRANS BC858B/ BC857B			INTERFERENCE SUPPR. CHOKE
CT 57113	830100385800	SMD TRANS BC858B/ BC857B	L 81061	810498205100	FERRITPERLE HF55 BTL 3,5X4,5
CT 57124	830100484800	SMD TRANS BC848B/ BC847B			FERRITE BEAD
CT 61043	830100484800	SMD TRANS BC848B/ BC847B	L 81062	814052636100	DR 0411 10UH 5%
CT 61053	830100484800	SMD TRANS BC848B/ BC847B	DR 10164	814052636100	DR 0411 10UH 5%
CT 81220	830100484800	SMD TRANS BC848B/ BC847B			
CT 81225	830100484800	SMD TRANS BC848B/ BC847B	Q 34043	838212104400	QUARZ 4,433619 MHZ
CT 85502	830100385800	SMD TRANS BC858B/ BC857B	Q 34044	838204900300	QUARZ 3,579545MHZ
			Q 80001	838208004000	QUARZ 4 MHZ
			Q 80951	838216204100	QUARZ 4 MHZ
D 40584	830921504500	DIODE 1N4148	R 40551	873229240700	DRW 4 1,8 OHM 10%
D 40586	830921504500	DIODE 1N4148	R 43006	870001124600	KSW 0204 75 OHM 5%
D 43055	830921504500	DIODE 1N4148	R 50047	876642460200	MSW 0207 1,1 OHM 1% ST
D 43056	830921504500	DIODE 1N4148	R 50048 Δ	870552103300	MOW 0411 22 OHM 5% LI
D 50023	830921502000	DIODE 1N4004	R 50050 Δ	870522705300	MOW 0411 150 OHM 5% LI
D 50048	830970301400	Z-DIODE ZPY5 6,2%	R 52004 Δ	870552105300	MOW 0411 150 OHM 5% LI
D 52001	830921504500	DIODE 1N4148	R 53002 Δ	870552102100	MOW 0411 6,8 OHM 5% LI
D 53003	830920100500	DIODE BA157	R 53009	871033814500	MGW AX 1 MOHM 5%
D 54001	830920426800	DIODE BYV16	R 53011 Δ	870552102100	MOW 0411 6,8 OHM 5% LI
D 54011	830920100500	DIODE BA157	R 53016	873018942500	DRW 9 10 OHM 10%
D 54022	830972033000	Z-DIODE 30 B 0,5W	R 53021 Δ	870522707100	MOW 0411 820 OHM 5%
D 57013	830921504500	DIODE 1N4148	R 53033 Δ	870552098500	MOW 0411 0,22 OHM 5% LI
D 57023	830921504500	DIODE 1N4148	R 53074 Δ	870556107100	MOW 0617 820 OHM 5% LI
D 60506 Δ	830951685400	DIODE BYT 54 M	R 54001 Δ	870552102500	MOW 0411 10 OHM 5% LI
D 60509 Δ	830966318000	Z-DIODE BTZ03D180	R 54006 Δ	870552100900	MOW 0411 2,2 OHM 5% LI
D 60512	830951675400	DIODE BYT53B	R 54022 Δ	870556111100	MOW 0617 39 KOHM 5% LI
D 60523	830856038400	GLR.SKB380C1500	R 60502	870008935600	KSW 0617 3 MOHM 2%
D 61016 Δ	830951717800	DIODE BYW178	R 60504	870008934700	KSW 0617 1,2 MOHM 2%
D 61037 Δ	830951710800	DIODE BYT108-400	R 60508 Δ	870556110500	MOW 0617 22 KOHM 5% LI
D 61056 Δ	830951717200	DIODE BYW172D	R 60509 Δ	870556110500	MOW 0617 22 KOHM 5% LI
D 85511	830994460100	LE DIODE TLHR 4601	R 60516	879005004600	ESTR.SK10-A 4,7 KOHM LIN
F 32109	860275506600	KERTRAP #66 5,6/6,6MHZ	R 61018 Δ	870552111900	MOW 0411 82 KOHM 5% LI
F 32121	814111138000	FILTER 7X7 360	R 62501 Δ	831120001800	PTC DUO B59709-T60-A110
F 32410	814053445100	SUPLU 7X7 #451	R 62502	831100501700	NTC 4,7 OHM 30%
F 32412	831900395300	OPFWIL K3953M	R 62549 Δ	876504916100	MSW SI 0414 4,7 MOHM VDE
F 32430	831900465400	OPFWIL K4654K	SI 40551 Δ	831561902800	SI LOET T1,6A 250V
F 34052	814111675000	FILTER 7X7 #750	SI 62501 Δ	831561700600	SI 5X20 T2,5A L 250V
IC 34015	830512524800	IC STV2248	T 52001	830328563700	TRANS.BC 637
IC 40550	830534726600	IC TDA7266B	T 53001	830290002000	TRANS.S2055M/ BU508DF
IC 50010	830533817500	IC TDA8174AW	T 60506	830280504000	TRANS.IRF BC 40 IOR ZNG.2
IC 60510	830533464600	IC TDA16846	TR 52001	092468680400	TRAF0 TREIBER
IC 61040	830520431700	IC LM317T	TR 53010 Δ	292210315700	TRAF0 DIODEN-SPLIT KPL
IC 61050	830520431700	IC LM317T			TRAF0 DIODEN-SPLIT KPL
IC 61060	830520570300	IC MC7805CT	TR 53020 Δ	292016651101	TRAF0 SPLIT TRANSFORMER CPL
IC 80500	830521006500	IC MC33164P-5RP	TR 53020 Δ	292016651101	DIODEN-SPLIT TRAF0
IC 80920	297980320100	IC 27C020 PROG.KPL	TR 61000 Δ	292015219703	DIODE SPLIT TRANSFORMER SPERRWANDLETRAF0
IC 81500	293052194200	PROZESSORPLATTE			REVERSE CONVERTER TRANSFORMER
WW.	830415513200	IC ST92195C9B1-S252			
IC 84501	830546133000	IC TSOP1330			
L 31043	814052644000	DR ST 0411-GRP 8,2UH 10%			
L 32109	814052690600	DR 0309 4,7UH 10% ST			
L 40512	814050525900	DR A AX-GA 27UH 10%			
L 52251	814051174900	DR AX 0411-GA 10UH 10%			

Es gelten die Vorschriften und Sicherheitshinweise gemäß dem Service Manual "Sicherheit", Mat.-Nummer 720108000000, sowie zusätzlich die eventuell abweichenden, landesspezifischen Vorschriften!



The regulations and safety instructions shall be valid as provided by the "Safety" Service Manual, part number 720108000000, as well as the respective national deviations.

ÄNDERUNGEN VORBEHALTEN / SUBJECT TO ALTERATION

Ersatzteilliste
Spare Parts List

1 / 2002

CHASSIS-FS-STEREO CUC 2121 MUL/DOLBY
CHASSIS-FS-STEREO CUC 2121 MUL/DOLBY

MATERIAL-NR. / PART NO.: 297040136500

POS. NR. POS. NO.	ABB. FIG.	MATERIAL-NR. PART NUMBER	ANZ. QTY.	BEZEICHNUNG (D)	DESCRIPTION (GB)
		297040136500		CHASSIS-FS-STEREO CUC 2121 MUL/DOLBY KEIN E-TEIL	CHASSIS TV STEREO CUC 2121 MUL/DOLBY NO SPARE PART
0100.000		295045010100		TUNER-PLL STEHEND	TUNER-PLL TOP ENTRY
0216.000		297033571100		TASTSCHALTER PROGRAMM+	KEY SWITCH PROGRAMME+
0216.000		297033571100		TASTSCHALTER PROGRAMM-	KEY SWITCH PROGRAMME-
0216.000		297033571100		TASTSCHALTER LAUTSTAERKE+	KEY SWITCH VOLUME+
0216.000		297033571100		TASTSCHALTER LAUTSTAERKE-	KEY SWITCH VOLUME-
0240.000		293033904200		KOPFHOERERBUCHSE 3,5 O.SCHALTER	HEADPHONE SOCKET 3,5 W/O SWITCH
0241.000		293031180503		CINCH-BUCHSE 3-FACH FBAS/NF L,R	CINCH SOCKET 3 FOLD FBAS/AF L,R
0247.000		293031190603		EURO-AV BUCHSENLEISTE 21-POL SW	EURO-AV SOCKET STRIP 21 P BLACK
0312.000		297006430104		ABDECKUNG EURO-AV	COVER EURO AV
0500.000		295041028400		BAUSTEIN STEREO MODUL	STEREO MODULE
0910.000	△	292107030100		FOKUSLEITUNG	FOCUSING CABLE
1000.000	△	096211130206	2	SICHERUNGSHALTER SI62501	FUSE HOLDER SI62501
2000.000	△	297033910600		NETZSCHALTER O.WISCHER	POWER SWITCH W/O WIPER
2200.000	△	293033995100		NETZ EINBAUGERAETESTECKER	APPLIANCE COUPLER W.CABLE
2400.000		293031530107		MONTAGECLIP IC40550	MOUNTING CLIP IC40550
2410.000		293031530208	2	MONTAGECLIP IC50010/T53001	MOUNTING CLIP IC50010/T53001
2420.000		293031531600		MONTAGECLIP T60506	MOUNTING CLIP T60506
2430.000		293031531605	3	MONTAGECLIP IC61040/61050/61060	MOUNTING CLIP IC61040/61050/61060
2450.000		293031562000	4	FOLIE WAERMELEITEND IC61040/61050/61060/T60506	FOIL HEAT CONDUCTING IC61040/61050/61060/T60506
				WW.=WAHLWEISE X=SIEHE GESONDERTE E-LISTE	WW.=OPTIONAL X=SEE SEPARATE PARTS LIST

POS. NR. POS. NO.	MATERIAL-NR. PART NUMBER	BEZEICHNUNG DESCRIPTION	POS. NR. POS. NO.	MATERIAL-NR. PART NUMBER	BEZEICHNUNG DESCRIPTION
C 34026	845296706400	ELKO 1000UF +50-20% 10V	C 81063	814054010400	EMIFIL 0,1 UF
C 40557	845299610700	ELKO 2200UF 20% 16V	CD 32411	830940159200	SMD DIODE BA591/BA592/BA782S
C 50047	845299618700	ELKO 1000UF 20% 35V	CD 32460	830940159200	SMD DIODE BA591/BA592/BA782S
C 50048	845299684700	ELKO 1000UF 20% 25V	CD 32470	830940159200	SMD DIODE BA591/BA592/BA782S
C 53002	851591110200	FOKO FKP1/4 8500PF 3,5% 1500V	CD 34041	830940159200	SMD DIODE BA591/BA592/BA782S
C 54011	865006704600	KERKO HV C 100PF 20% 1KV	CD 80501	830940159200	SMD DIODE BA591/BA592/BA782S
C 54012	845299618700	ELKO 1000UF 20% 35V			
C 60501	865008112500	KERKO HV C 1000PF 20% 1KV	CIC 80910	830581409400	SMD IC MC14094BD
C 60509	851591104500	FOKO FKP1 680PF 10% 1600V	CIC 80930	830595012900	SMD IC ST92R195C9D1
C 60512	865008111100	KERKO HV C 270PF 20% 2KV	CIC 82501	830596000800	SMD IC M24C08CM1TR
C 60523	865008112500	KERKO HV C 1000PF 20% 1KV			
C 60524	865008112500	KERKO HV C 1000PF 20% 1KV			
C 60526	865008112500	KERKO HV C 1000PF 20% 1KV	CL 40511	810498233100	SMD DAEMPF-PERLE 0805
C 60527	865008112500	KERKO HV C 1000PF 20% 1KV			
C 60528	845209711500	ELKO SNT #40 150UF 385V/400V	CT 32111	830100484800	SMD TRANS BC848B/ BC847B
WW.	845199711500	ELKO 19 150UF 385V	CT 32122	830100385800	SMD TRANS BC858B/ BC857B
C 61016	851591104000	FOKO FKP1 220PF 10% 1600V	CT 32123	830100484800	SMD TRANS BC848B/ BC847B
C 61036	865006704600	KERKO HV C 100PF 20% 1KV	CT 32124	830100385800	SMD TRANS BC858B/ BC857B
C 61056	865006704600	KERKO HV C 100PF 20% 1KV	CT 32132	830100484800	SMD TRANS BC848B/ BC847B
C 62501	851179301800	FOKO MP3 0,1UF 20% 275VW	CT 32460	830100484800	SMD TRANS BC848B/ BC847B
C 62521	866009623800	KERKO SI 2200PF 20%	CT 32470	830100484800	SMD TRANS BC848B/ BC847B
C 62522	866009623800	KERKO SI 2200PF 20%	CT 32480	830100484800	SMD TRANS BC848B/ BC847B
C 62549	866009623400	KERKO SI 1000PF 20%	CT 34031	830100385800	SMD TRANS BC858B/ BC857B

ÄNDERUNGEN VORBEHALTEN / SUBJECT TO ALTERATION

GRUNDIG

TV

POS. NR. POS. NO.	MATERIAL-NR. PART NUMBER	BEZEICHNUNG DESCRIPTION
CT 40581	830100385800	SMD TRANS BC858B/ BC857B
CT 43010	830100385800	SMD TRANS BC858B/ BC857B
CT 43015	830100484800	SMD TRANS BC848B/ BC847B
CT 50005	830100484800	SMD TRANS BC848B/ BC847B
CT 50015	830100484800	SMD TRANS BC848B/ BC847B
CT 50040	830100484800	SMD TRANS BC848B/ BC847B
CT 50050	830100484800	SMD TRANS BC848B/ BC847B
CT 50055	830100484800	SMD TRANS BC848B/ BC847B
CT 52260	830100385800	SMD TRANS BC858B/ BC857B
CT 57020	830100385800	SMD TRANS BC858B/ BC857B
CT 57021	830100385800	SMD TRANS BC858B/ BC857B
CT 57112	830100385800	SMD TRANS BC858B/ BC857B
CT 57113	830100385800	SMD TRANS BC858B/ BC857B
CT 57124	830100484800	SMD TRANS BC848B/ BC847B
CT 61043	830100484800	SMD TRANS BC848B/ BC847B
CT 61053	830100484800	SMD TRANS BC848B/ BC847B
CT 81220	830100484800	SMD TRANS BC848B/ BC847B
CT 81225	830100484800	SMD TRANS BC848B/ BC847B
CT 85502	830100385800	SMD TRANS BC858B/ BC857B
D 40584	830921504500	DIODE 1N4148
D 40586	830921504500	DIODE 1N4148
D 43055	830921504500	DIODE 1N4148
D 43056	830921504500	DIODE 1N4148
D 50023	830921502000	DIODE 1N4A04
D 50048	830970301400	Z-DIODE ZP2Y5,6 2%
D 52001	830921504500	DIODE 1N4148
D 53003	830920100500	DIODE BA157
D 54001	830920426800	DIODE BYV16
D 54011	830920100500	DIODE BA157
D 54022	830927033000	Z-DIODE 30 B 0,5W
D 57013	830921504500	DIODE 1N4148
D 57023	830921504500	DIODE 1N4148
D 60506	830951685400	DIODE BYT 54 M
D 60509	830966318000	Z-DIODE BZT03D180
D 60512	830951675400	DIODE BYT53B
D 60523	830856038400	GLR.SKB380C1500
D 61016	830951717800	DIODE BYW178
D 61037	830951710800	DIODE BYT108-400
D 61056	830951717200	DIODE BYW172D
D 85511	830994460100	LE DIODE TLHR 4601
F 32109	860275506600	KERTRAP #66 5,5/6/6,5MHZ
F 32121	814111136000	FILTER 7X7 360
F 32410	814053445100	SPULE 7X7 #451
F 32412	831900395300	OFWFL K3953M
F 32430	831900465400	OFWFL K4654K
F 34052	814111675000	FILTER 7X7 #750
IC 34015	830512524800	IC STV2248
IC 40550	830534726600	IC TDA7266B
IC 50010	830533817500	IC TDA8174AW
IC 60510	830533464600	IC TDA16846
IC 61040	830520431700	IC LM317T
IC 61050	830520431700	IC LM317T
IC 61060	830520570300	IC MC7805CT
IC 80500	830521006500	IC MC33164P-SRP
IC 80920	297980320100	IC 27C020 PROG.KPL
IC 81500	293052194200	PROZESSORPLATTE
WW.	830415513200	IC ST92195C9B1-S252
IC 84501	830546133000	IC TSOP1330
L 31043	814052644000	DR ST 0411-GRP 8,2UH 10%
L 32109	814052690600	DR 0309 4,7UH 10% ST
L 40512	814050525900	DR A AX-GA 27UH 10%
L 52251	814051174900	DR AX 0411-GA 10UH 10%

Es gelten die Vorschriften und Sicherheitshinweise gemäß dem Service Manual "Sicherheit", Mat.-Nummer 720108000000, sowie zusätzlich die eventuell abweichenden, landesspezifischen Vorschriften!



The regulations and safety instructions shall be valid as provided by the "Safety" Service Manual, part number 720108000000, as well as the respective national deviations.

ÄNDERUNGEN VORBEHALTEN / SUBJECT TO ALTERATION

Ersatzteilliste Spare Parts List

2 / 2002

GRUNDIG

TV

CHASSIS-FS-STEREO CUC 2121 INL DOLBY CHASSIS TVSTEREO CUC 2121 INL DOLBY

MATERIAL-NR. / PART NO.: 297040136600

POS. NR. POS. NO.	ABB. FIG.	MATERIAL-NR. PART NUMBER	ANZ. QTY.	BEZEICHNUNG (D)	DESCRIPTION (GB)
		297040136600		CHASSIS-FS-STEREO CUC 2121 INL DOLBY KEIN E-TEIL	CHASSIS TV STEREO CUC 2121 INL DOLBY NO SPARE PART
0100.000		295045010100		TUNER-PLL STEHEND	TUNER-PLL TOP ENTRY
0215.000		297033571100		TASTSCHALTER PROGRAMM +	KEY SWITCH PROGRAMME +
0215.000		297033571100		TASTSCHALTER PROGRAMM -	KEY SWITCH PROGRAMME -
0215.000		297033571100		TASTSCHALTER LAUTSTAERKE +	KEY SWITCH VOLUME +
0215.000		297033571100		TASTSCHALTER LAUTSTAERKE -	KEY SWITCH VOLUME -
0240.000		293033904200		KOPFHOERERBUCHSE 3,5mm O.SCHALTER	HEADPHONE SOCKET 3.5mm W/O SWITCH
0241.000		293031680503		CINCH-BUCHSE 3-FACH FBAS/NF L,R	CINCH SOCKET 3 FOLD FBAS/AF L,R
0247.000		293031190603		EURO-AV BUCHSENLEISTE 21-POL SW	EURO-AV SOCKET STRIP 21 PIN BLACK
0312.000		297006430104		EURO-AV ABDECKUNG	EURO-AV COVER
0500.000		295041028300	X	BAUSTEIN STEREO	MODULE STEREO
0910.000	△	292107030100		FOKUSLEITUNG	FOCUSING CABLE
1000.000	△	096211130206	2	SICHERUNGSHALTER Si62501	FUSE HOLDER Si62501
2000.000	△	297033910600		NETZSCHALTER O.WISCHER	POWER SWITCH W/O WIPER
2200.000	△	293033995100		NETZ EINBAUGERAETESTECKER	APPLIANCE CLOOPER
2400.000		293031530107		MONTAGECLIP IC40550	MOUNTING CLIP IC40550
2410.000		293031530208	2	MONTAGECLIP T53001/IC50010	MOUNTING CLIP T53001/IC50010
2440.000		293031531600		MONTAGECLIP T60506	MOUNTING CLIP T60506
2445.000		293031531605	3	MONTAGECLIP IC61040/61050/61060	MOUNTING CLIP IC61040/61050/61060
2470.000		293031562000	4	FOLIE WAERMELEITEND	FOIL HEAT CONDUCTING
				T60506/IC61040/61050/61060	T60506/IC61040/61050/61060
				X = SIEHE GESONDERTE E-LISTE WW. = WAHLWEISE	X = SEE SEPARATE PARTS LIST WW. = OPTIONAL

POS. NR. POS. NO.	MATERIAL-NR. PART NUMBER	BEZEICHNUNG DESCRIPTION	POS. NR. POS. NO.	MATERIAL-NR. PART NUMBER	BEZEICHNUNG DESCRIPTION
C 34026	845296706400	ELKO 1000UF +50-20% 10V	CD 80501	830940159200	SMD DIODE BA591
C 40557	845299610700	ELKO 2200UF 20% 16V			
C 50047	845299618700	ELKO 1000UF 20% 35V	CIC 80910	830581409400	SMD IC MC14094BD
C 50048	845299864700	ELKO 1000UF 20% 25V	CIC 80930	830595012900	SMD IC ST92R195C9Q1
C 53002	851591111400	FOKO KF #35 9000PF 3,5% 1500V	CIC 82501	830596000800	SMD IC M24C08CM1TR
C 54011	865006704600	KERKO HV C 100PF 20% 1KV			
C 54012	845299618700	ELKO 1000UF 20% 35V	CL 40511	810498233100	SMD DAEMPF-PERLE 0805 BLM SMD DAMPING BEAD
C 60501	865008112500	KERKO HV C 1000PF 20% 1KV			
C 60509	851591104500	FOKO FKP1 680PF 10% 1600V			
C 60512	865008111100	KERKO HV C 270PF 20% 2KV	CT 32124	830100385800	SMD TRANS BC858B/BC857B
C 60523	865008112500	KERKO HV C 1000PF 20% 1KV	CT 34031	830100385800	SMD TRANS BC858B/BC857B
C 60524	865008112500	KERKO HV C 1000PF 20% 1KV	CT 40581	830100385800	SMD TRANS BC858B/BC857B
C 60526	865008112500	KERKO HV C 1000PF 20% 1KV	CT 43010	830100385800	SMD TRANS BC858B/BC857B
C 60527	865008112500	KERKO HV C 1000PF 20% 1KV	CT 43015	830100484800	SMD TRANS BC848B/BC847B
C 61016	851591104000	FOKO FKP1 220PF 10% 1600V	CT 50005	830100484800	SMD TRANS BC848B/BC847B
C 61036	865006704600	KERKO HV C 1000PF 20% 1KV	CT 50015	830100484800	SMD TRANS BC848B/BC847B
C 61056	865006704600	KERKO HV C 100PF 20% 1KV	CT 50040	830100484800	SMD TRANS BC848B/BC847B
C 62501 △	851179301800	FOKO MP3 0,1UF 20% 275V	CT 50050	830100484800	SMD TRANS BC848B/BC847B
C 62521 △	866009623800	KERKO SI 2200PF 20% 400V	CT 50055	830100484800	SMD TRANS BC848B/BC847B
C 62522 △	866009623800	KERKO SI 2200PF 20% 400V	CT 52260	830100385800	SMD TRANS BC858B/BC857B
C 62549 △	866009623400	KERKO SI 1000PF 20% 400V	CT 57020	830100385800	SMD TRANS BC858B/BC857B
C 81063	814054010400	EMIFIL 0,1 UF -GR	CT 57021	830100385800	SMD TRANS BC858B/BC857B

ÄNDERUNGEN VORBEHALTEN / SUBJECT TO ALTERATION

POS. NR. POS. NO.	MATERIAL-NR. PART NUMBER	BEZEICHNUNG DESCRIPTION	POS. NR. POS. NO.	MATERIAL-NR. PART NUMBER	BEZEICHNUNG DESCRIPTION
CT 57112	830100385800	SMD TRANS BC858B/BC857B	L 60506	810498205700	FERRITPERLE 3,6UH 5720500
CT 57113	830100385800	SMD TRANS BC858B/BC857B	L 61038	810498200300	FERRITPERLE BL02RN2
CT 57124	830100484800	SMD TRANS BC848B/BC847B			FERRITE BEAD
CT 61043	830100484800	SMD TRANS BC848B/BC847B	L 62501 △	295008269700	FUNKENTSTOERDROSSEL INTERFERENCE CHOKE
CT 61053	830100484800	SMD TRANS BC848B/BC847B	L 81061	810498205100	FERRITPERLE HF55 BTL 3,5X FERRITE BEAD
CT 81220	830100484800	SMD TRANS BC848B/BC847B	L 81062	814052636100	DR 0411 10UH 5%
CT 81225	830100484800	SMD TRANS BC848B/BC847B	L 81064	814052636100	DR 0411 10UH 5% CHOKE
CT 85502	830100385800	SMD TRANS BC858B/BC857B			
D 40584	830921504500	DIODE 1N4148			
D 40586	830921504500	DIODE 1N4148			
D 43055	830921504500	DIODE 1N4148	Q 34043	838212104400	QUARZ 4,433619MHZ
D 43056	830921504500	DIODE 1N4148	Q 80001	838208004000	QUARZ 4MHZ
D 50023	830921502000	DIODE 1N4004	Q 80951	838216204100	QUARZ 4MHZ
D 50048	830970301400	Z-DIODE ZPY5,6 2%			
D 52001	830921504500	DIODE 1N4148	R 40551	873229240700	DRW 4 1,8 OHM 10%
D 53003	830920100500	DIODE BA157	R 43006	870001124600	KSW 0204 75 OHM 5%
D 54001	830920426800	DIODE BYV16	R 50047	876642460200	MSW 0207 1,1 OHM 1%
D 54011	830920100500	DIODE BA157	R 50048 △	870552103300	MOW 0411 22 OHM 5%
D 54022	830972033000	Z-DIODE 30B 0,5W	R 50050 △	870522705300	MOW 0411 150 OHM 5%
D 57013	830921504500	DIODE 1N4148	R 52004 △	870552105300	MOW 0411 150 OHM 5%
D 57023	830921504500	DIODE 1N4148	R 53002 △	870042909700	KSW NB 0207 10 KOHM 5%
D 60506 △	830951685400	DIODE BYT54M	R 53009	871033814500	MGW AX 1 MOHM 5%
D 60509 △	830966318000	Z-DIODE BZT03D180	R 53011 △	870552102100	MOW 0411 6,8 OHM 5%
D 60512	830951675400	DIODE BYT53B	R 53016	873018942500	DRW 9 10 OHM 10%
D 60523	830856038400	GLR.SKB380C1500	R 53021 △	870522707100	MOW 0411 8,2 OHM 5%
D 61016 △	830951717800	DIODE BYW178	R 53033 △	870552100500	MOW 0411 1,5 OHM 5%
D 61036 △	830951710800	DIODE BYT108-400	R 53074 △	870556107100	MOW 0617 10 OHM 5%
D 61056 △	830951717200	DIODE BYW172D	R 54001 △	870552102500	MOW 0411 20 OHM 5%
D 85001	830994460100	LE DIODE TLHR 4601	R 54006 △	870552100900	MOW 0411 2,2 OHM 5%
			R 54022 △	870556111100	MOW 0617 39 KOHM 5%
F 32109	860275652100	KERTRAP #521 5,5MHZ TPSRA	R 60502	870006933500	KSW 0617 3 MOHM 2%
F 32410	814110760100	SPULE 7X7 #601 SIGN107601	R 60504	870006934700	KSW 0617 1,2 MOHM 2%
			R 60508 △	870556110500	MOW 0617 22 KOHM 5%
F 2412	831900198400	OFWFL G1985M	R 60509 △	870556110500	MOW 0617 22 KOHM 5%
F 34052	814111675000	FILTER 7X7 #750 SIGN11675	R 60516	879005004600	ESTR.SK10-A 4,7 KOHM LIN
			R 61018 △	870552119100	MOW 0411 82 KOHM 5%
IC 34015	830512524600	IC STV2246	R 62501 △	831120001600	PTC DUO T251-A80-A10
IC 40550	830534726600	IC TDA7266B	R 62502	831100501700	NTC 4,7 OHM 30%
IC 50010	830533817500	IC TDA8174AW	R 62549 △	876504916100	MSW SI 0414 4,7 MOHM VDE
IC 60510	830533464600	IC TDA16846			
IC 61040	830520431700	IC LM317T	SI 40551 △	831561902800	SI LOET T1,6A 250V
IC 61050	830520431700	IC LM317T	SI 62501 △	831561700600	SI 5X20 T2,5A L 250V
IC 61060	830520570300	IC MC7805CT			
IC 80500	830521006500	IC MC33164P-5RP	T 52001	830328563700	TRANS BC637
IC 80920	297980310100	IC 27C020 PROG.KPL	T 53001	830290002000	TRANS S2055N
IC 81500	293052194100	PROZESSORPLATTE	T 60506	830280504000	TRANS IRBC40
WW.	830415512200	IC ST92195C9B1-S242			
IC 84501	830546133000	IC TSOP1330	TR 52001	092468680400	TRAFO TREIBER TRANSFORMER DRIVER
L 31043	814052644000	DR ST 0411-GRP 8,2UH 10%	TR 53010 △	292210315700	TRAFO DIODEN-SPLIT TRANSFORMER DIODE SPLIT
L 32023	814052653000	DR 0411 33UH 10%	WW. △	292016651101	TRAFO DIODEN-SPLIT TRANSFORMER DIODE SPLIT
L 32026	814052653000	DR 0411 33UH 10%			
L 32109	814052690600	DR 0309 4,7UH 10%	TR 61000 △	292015219703	SPERRWANDLERTRAFO B.O.TYPE CONVERTER TRANSFORMER
L 40512	814050525900	DR A-AX-GA 27UH 10%			
L 52251	814051174900	DR AX 0411-GA 10UH 10%			
L 52256	814052632000	DR AX 0411-GA 3,3UH 10% CHOKE			
L 53003	810498205600	FERRITPERLE HF70 BTL 3,5X FERRITE BEAD			
L 53011	814050524900	DR A-AX-GA 10UH 10% CHOKE			
L 53021	292031149500	LINEARITAETSREGLER LINEARITY CONTROL			
L 53074	092468700101	ZB-SPULE ZB COIL			

Es gelten die Vorschriften und Sicherheitshinweise gemäß dem Service Manual "Sicherheit", Mat.-Nummer 720108000000, sowie zusätzlich die eventuell abweichenden, landesspezifischen Vorschriften!



The regulations and safety instructions shall be valid as provided by the "Safety" Service Manual, part number 720108000000, as well as the respective national deviations.

ÄNDERUNGEN VORBEHALTEN / SUBJECT TO ALTERATION

Ersatzteilliste
Spare Parts List

2 / 2002

CHASSIS-FS-STEREO CUC 2121 INL DOLBY
CHASSIS TV STEREO CUC 2121 INL DOLBY

MATERIAL-NR. / PART NO.: 297040136700

POS. NR. POS. NO.	ABB. FIG.	MATERIAL-NR. PART NUMBER	ANZ. QTY.	BEZEICHNUNG ①	DESCRIPTION ②
		297040136700		CHASSIS-FS-STEREO CUC 2121 INL DOLBY KEIN E-TEIL	CHASSIS TV STEREO CUC 2121 INL DOLBY NO SPARE PART
0100.000		295045010100		TUNER-PLL STEHEND	TUNER-PLL TOP ENTRY
0215.000		297033571100		TASTSCHALTER PROGRAMM +	KEY SWITCH PROGRAMME +
0215.000		297033571100		TASTSCHALTER PROGRAMM -	KEY SWITCH PROGRAMME -
0215.000		297033571100		TASTSCHALTER LAUTSTÄRKE +	KEY SWITCH VOLUME +
0215.000		297033571100		TASTSCHALTER LAUTSTÄRKE -	KEY SWITCH VOLUME -
0240.000		293033904200		KOPFHÖRERBUCHSE 3,5mm O.SCHALTER	HEADPHONE SOCKET 3,5mm W/O SWITCH
0241.000		293031680503		CINCH-BUCHSE 3-FACH FBAS/NF L,R	CINCH SOCKET 3 FOLD FBAS/AF L,R
0247.000		293031196603		EURO-AV BUCHSENLEISTE 21-POL SW	EURO-AV SOCKET STRIP 21 PIN BLACK
0312.000		297006430104		ABDECKUNG EURO-AV	COVER EURO AV
0500.000		295041028300	X	BAUSTEIN STEREO	MODULE STEREO
0910.000	△	292107030100		FOKUSLEITUNG	FOCUSING CABLE
1000.000	△	096211130206	2	SICHERUNGSHALTER SI62501	FUSE HOLDER SI62501
1110.000		293031531605		MONTAGECLIP	MOUNTING CLIP
2400.000		293031530107		MONTAGECLIP IC40550	MOUNTING CLIP IC40550
2410.000		293031530208	2	MONTAGECLIP T53001/IC50010	MOUNTING CLIP T53001/IC50010
2440.000		293031531600		MONTAGECLIP T60506	MOUNTING CLIP T60506
2445.000		293031531605	3	MONTAGECLIP IC61040/61050/61060	MOUNTING CLIP IC61040/61050/61060
2470.000		293031562000	4	FOLIE WAERMELEITEND T60506/ IC61040/61050/61060	FOIL HEAT CONDUCTING T60506/ IC61040/61050/61060
				X = SIEHE GESONDERTE E-LISTE WW. = WAHLWEISE	X = SEE SEPARATE PARTS LIST WW. = OPTIONAL

POS. NR. POS. NO.	MATERIAL-NR. PART NUMBER	BEZEICHNUNG DESCRIPTION	POS. NR. POS. NO.	MATERIAL-NR. PART NUMBER	BEZEICHNUNG DESCRIPTION
C 34026	845296706400	ELKO 1000UF +50-20% 10V	CIC 80910	830581409400	SMD IC MC14094BD
C 40557	845299610700	ELKO 2200UF 20% 16V	CIC 80930	830595012900	SMD IC ST92R195C9Q1
C 50047	845299618700	ELKO 1000UF 20% 35V	CIC 82501	830596000800	SMD IC M24C08CM1TR
C 50048	845299864700	ELKO 1000UF 20% 25V			
C 53002	851591111400	FOKO KF #35 9000PF 3,5% 1500V	CL 40511	810498233100	SMD DAEMPFF-PERLE 0805 BLM SMD DAMPING BEAD
C 54011	865006704600	KERKO HV C 100PF 20% 1KV	CT 32124	830100385800	SMD TRANS BC858B/BC857B
C 54012	845299618700	ELKO 1000UF 20% 35V	CT 34031	830100385800	SMD TRANS BC858B/BC857B
C 60501	865008112500	KERKO HV C 1000PF 20% 1Kv	CT 40581	830100385800	SMD TRANS BC858B/BC857B
C 60509	851591104500	FOKO FKP1 680PF 10% 1600V	CT 43010	830100385800	SMD TRANS BC858B/BC857B
C 60512	865008111100	KERKO HV C 270PF 20% 2KV	CT 43015	830100484800	SMD TRANS BC848B/BC847B
C 60523	865008112500	KERKO HV C 1000PF 20% 1KV	CT 50005	830100484800	SMD TRANS BC848B/BC847B
C 60524	865008112500	KERKO HV C 1000PF 20% 1KV	CT 50015	830100484800	SMD TRANS BC848B/BC847B
C 60526	865008112500	KERKO HV C 1000PF 20% 1KV	CT 50040	830100484800	SMD TRANS BC848B/BC847B
C 60527	865008112500	KERKO HV C 1000PF 20% 1KV	CT 50050	830100484800	SMD TRANS BC848B/BC847B
C 61016	851591104000	FOKO FKP1 220PF 10% 1600V	CT 50055	830100484800	SMD TRANS BC848B/BC847B
C 61036	865006704600	KERKO HV C 100PF 20% 1KV	CT 52260	830100385800	SMD TRANS BC858B/BC857B
C 61056	865006704600	KERKO HV C 100PF 20% 1KV	CT 57020	830100385800	SMD TRANS BC858B/BC857B
C 62501	851179301800	FOKO MP3 0,1UF 20% 275V	CT 57021	830100385800	SMD TRANS BC858B/BC857B
C 62521	866009623800	KERKO SI 2200PF 20% 400V	CT 57112	830100385800	SMD TRANS BC858B/BC857B
C 62522	866009623800	KERKO SI 2200PF 20% 400V	CT 57113	830100385800	SMD TRANS BC858B/BC857B
C 62549	866009623400	KERKO SI 1000PF 20% 400V	CT 57124	830100484800	SMD TRANS BC848B/BC847B
C 81063	814054010400	EMIFIL 0,1 UF -GR	CT 61043	830100484800	SMD TRANS BC848B/BC847B
CD 80501	830940159200	SMD DIODE BA591	CT 61053	830100484800	SMD TRANS BC848B/BC847B

ÄNDERUNGEN VORBEHALTEN / SUBJECT TO ALTERATION

GRUNDIG

TV

POS. NR. POS. NO.	MATERIAL-NR. PART NUMBER	BEZEICHNUNG DESCRIPTION	POS. NR. POS. NO.	MATERIAL-NR. PART NUMBER	BEZEICHNUNG DESCRIPTION
CT 81220	830100484800	SMD TRANS BC848B/BC847B	L 81061	810498205100	FERRITPERLE HF55 BTL 3,5X
CT 81225	830100484800	SMD TRANS BC848B/BC847B	L 81062	814052636100	FERRITE BEAD
CT 85502	830100385800	SMD TRANS BC858B/BC857B	L 81064	814052636100	DR 0411 10UH 5% DR 0411 10UH 5% CHOKE
D 40584	830921504500	DIODE 1N4148	Q 34043	838212104400	QUARZ 4,433619MHZ
D 40586	830921504500	DIODE 1N4148	Q 80001	838208004000	QUARZ 4 MHZ
D 43055	830921504500	DIODE 1N4148	Q 80951	838216204100	QUARZ 4 MHZ
D 43056	830921504500	DIODE 1N4148	R 40551	873229240700	DRW 4 1,8 OHM 10%
D 50023	830921502000	DIODE 1N4004	R 43006	870001124600	KSW 0204 75 OHM 5%
D 50048	830970301400	Z-DIODE ZPY5,6 2%	R 50047	876642460200	MSW 0207 1,1 OHM 1%
D 52001	830921504500	DIODE 1N4148	R 50048	870552103300	MOW 0411 22 OHM 5%
D 53003	830920100500	DIODE BA157	R 50050	870522705300	MOW 0411 150 OHM 5%
D 54001	830920426800	DIODE BYV16	R 52004	870552105300	MOW 0411 150 OHM 5%
D 54011	830920100500	DIODE BA157	R 53002	870042909700	KSW NB 0207 10 KOHM 5%
D 54022	830972033000	Z-DIODE 30B 0,5W	R 53009	871033814500	MGW AX 1 MOHM 5%
D 57013	830921504500	DIODE 1N4148	R 53011	870552102100	MOW 0411 6,8 OHM 5%
D 57023	830921504500	DIODE 1N4148	R 53016	873018942500	DRW 9 10 OHM 10%
D 60506	830951685400	DIODE BYT54M	R 53021	870522707100	MOW 0411 820 OHM 5%
D 60509	830966318000	Z-DIODE BZT03D180	R 53033	870552098500	MOW 0411 0,22 OHM 5%
D 60512	830951675400	DIODE BYT53B	R 53074	870556107100	MOW 0411 820 OHM 5%
D 60523	830856038400	GLR.SKB380C1500	R 54001	870552102500	MOW 0411 10 OHM 5%
D 61016	830951717800	DIODE BYW178	R 54006	870552100900	MOW 0411 2,2 OHM 5%
D 61036	830951710800	DIODE BYT108-400	R 54022	870556111100	MOW 0617 39 KOHM 5%
D 61056	830951717200	DIODE BYW172	R 60502	870006935600	KSW 0617 3 MOHM 2%
D 85001	830994460100	LE DIODE TLHR 4601	R 60504	870006934700	KSW 0617 1,2 MOHM 2%
F 32109	860275652100	KERTRAP #521 5,5MHZ	R 60508	870556110500	MOW 0617 22 KOHM 5%
F 32410	814110760100	SPULE 7X7 #601 SIGN107601	R 60509	870556110500	MOW 0617 22 KOHM 5%
F 32412	831900198400	OFWFL G1985M	R 60516	879005004600	ESTR.SK10-A 4,7 KOHM LIN
F 34052	814111675000	FILTER 7X7 #750 SIGN11675	R 61018	870552111900	MOW 0411 82 KOHM 5%
IC 34015	830512524600	IC STV2246	R 62501	831120001800	PTC DUO B59709-T60-A110
IC 40550	830534726600	IC TDA7266B	R 62502	831100501700	NTC 4,7 OHM 30%
IC 50010	830533817500	IC TDA8174AW	R 62549	876504916100	MSW SI 0414 4,7 MOHM
IC 60510	830533464600	IC TDA16846	SI 40551	831561902800	SI LOET T1,6A 250V
IC 61040	830520431700	IC LM317T	SI 62501	831561700600	SI SX20 T2,5A L 250V
IC 61050	830520431700	IC LM317T	T 52001	830328563700	TRANS BC637
IC 61060	830520570300	IC MC7805CT	T 53001	830290002000	TRANS S2055N
IC 80500	830521006500	IC MC33164P-5RP	T 60506	830280504000	TRANS IRFBC40
IC 80920	297980310100	IC 27C020 PROG.KPL	TR 52001	092468680400	TRAFO TREIBER TRANSFORMER DRIVER
IC 81500	293052194100	PROZESSORPLATTE	TR 53010	292210315700	TRAFO DIODEN-SPLIT TRANSFORMER DIODE SPLIT
WW.	830415512200	IC ST92195C9B1-S242	WW. △	292016651101	TRANSFORMER DIODE SPLIT TRANSFORMER DIODE SPLIT
IC 84501	830546133000	IC TSOP1330	TR 61000	292015219703	SPERRWANDLERTRAFO B.O.TYPE CONVERTER TRANSFORMER
L 31043	814052644000	DR ST 0411-GRP 8,2UH 10%			
L 32023	814052653000	DR 0411 33UH 10%			
L 32026	814052653000	DR 0411 33UH 10%			
L 32109	814052690600	DR 0309 4,7UH 10%			
L 40512	814050525900	DR AX 0411-GA 27UH 10%			
L 52251	814051174900	DR AX 0411-GA 10UH 10%			
L 52256	814052632000	DR AX 0411-GA 3,3UH 10% CHOKE			
L 53003	810498205600	FERRITPERLE HF70 BTL 3,5X FERRITE BEAD			
L 53011	814050524900	DR A-AX-GA 10UH 10% CHOKE			
L 53021	292031149500	LINEARITAETSREGLER LINEARITY CONTROL			
L 53074	092468700101	ZB-SPULE ZB COIL			
L 60506	810498205700	FERRITPERLE 3,6UH 5720500			
L 61038	810498200300	FERRITPERLE BL02RN2-R62 FERRITE BEAD			
L 62501	295008269700	FUNKENTSTOERDROSSEL INTERFERENCE CHOKE			

Es gelten die Vorschriften und Sicherheitshinweise gemäß dem Service Manual "Sicherheit", Mat.-Nummer 720108000000, sowie zusätzlich die eventuell abweichenden, landesspezifischen Vorschriften!



The regulations and safety instructions shall be valid as provided by the "Safety" Service Manual, part number 720108000000, as well as the respective national deviations.

ÄNDERUNGEN VORBEHALTEN / SUBJECT TO ALTERATION

Ersatzteilliste Spare Parts List

2 / 2002

GRUNDIG

TV

CHASSIS-FS-STEREO CUC 2121 INL DOLBY CHASSIS TV STEREO CUC 2121 INL DOLBY

MATERIAL-NR. / PART NO.: 297040136800

Table with 5 columns: POS. NR./POS. NO., ABB./FIG., MATERIAL-NR./PART NUMBER, ANZ./QTY., BEZEICHNUNG/DESCRIPTION. Contains parts for chassis, tuner, and various clips.

Table with 5 columns: POS. NR./POS. NO., MATERIAL-NR./PART NUMBER, BEZEICHNUNG/DESCRIPTION, POS. NR./POS. NO., MATERIAL-NR./PART NUMBER, BEZEICHNUNG/DESCRIPTION. Contains parts like ELKO capacitors, FOKO FKP, and SMD diodes.

ÄNDERUNGEN VORBEHALTEN / SUBJECT TO ALTERATION

Table with 5 columns: POS. NR./POS. NO., MATERIAL-NR./PART NUMBER, BEZEICHNUNG/DESCRIPTION, POS. NR./POS. NO., MATERIAL-NR./PART NUMBER, BEZEICHNUNG/DESCRIPTION. Contains parts like SMD transistors, diodes, and transformers.

Es gelten die Vorschriften und Sicherheitshinweise gemäß dem Service Manual "Sicherheit", Mat.-Nummer 720108000000, sowie zusätzlich die eventuell abweichenden, landesspezifischen Vorschriften!



The regulations and safety instructions shall be valid as provided by the "Safety" Service Manual, part number 720108000000, as well as the respective national deviations.

ÄNDERUNGEN VORBEHALTEN / SUBJECT TO ALTERATION

Ersatzteilliste Spare Parts List

3 / 2002

CHASSIS-FS-STEREO CUC 2121 GB DOLBY CHASSIS TV STEREO CUC 2121 GB DOLBY

MATERIAL-NR. / PART NO.: 297040137200

POS. NR. POS. NO.	ABB. FIG.	MATERIAL-NR. PART NUMBER	ANZ. QTY.	BEZEICHNUNG (D)	DESCRIPTION (GB)
		297040137200		CHASSIS-FS-STEREO CUC 2121 GB DOLBY KEIN E-TEIL	CHASSIS TV STEREO CUC 2121 GB DOLBY NO SPARE PART
0100.000		295045010100		TUNER-PLL STEHEND	TUNER-PLL TOP ENTRY
0215.000		297033571100		TASTSCHALTER PROGRAMM +	KEY SWITCH PROGRAMME +
0215.000		297033571100		TASTSCHALTER PROGRAMM -	KEY SWITCH PROGRAMME -
0215.000		297033571100		TASTSCHALTER LAUTSTAERKE +	KEY SWITCH VOLUME +
0215.000		297033571100		TASTSCHALTER LAUTSTAERKE -	KEY SWITCH VOLUME -
0240.000		293033904200		KOPFHOERERBUCHSE 3,5mm O.SCHALTER	HEADPHONE SOCKET 3,5mm W/O SWITCH
0241.000		293031680503		CINCH-BUCHSE 3-FACH FBAS/NF L,R	CINCH SOCKET 3 FOLD FBAS/AF L,R
0247.000		293031190603		EURO-AV BUCHSENLEISTE 21-POL SW	EURO-AV SOCKET STRIP 21 PIN BLACK
0500.000		295041028400	X	BAUSTEIN STEREO	STEREO MODULE
0910.000	△	292107030100		FOKUSLEITUNG	FOCUSING CABLE
1000.000	△	096211130206	2	SICHERUNGSHALTER SI62501	FUSE HOLDER SI62501
2000.000	△	297033910600		NETZSCHALTER O.WISCHER	POWER SWITCH W/O WIPER
2200.000	△	293033995100		NETZ EINBAUGERAETESTECKER	APPLIANCE COUPLER
2400.000		293031530107		MONTAGECLIP IC40550	MOUNTING CLIP IC40550
2410.000		293031530208	2	MONTAGECLIP T53001/IC50010	MOUNTING CLIP T53001/IC50010
2440.000		293031531600		MONTAGECLIP T60506	MOUNTING CLIP T60506
2445.000		293031531605	3	MONTAGECLIP IC61040/61050/61060	MOUNTING CLIP IC61040/61050/61060
2470.000		293031562000	4	FOILIE WAERMELEITEND T60506/ IC61040/61050/61060	FOIL HEAT CONDUCTING T60506/ IC61040/61050/61060
				X = SIEHE GESONDERTE E-LISTE WW. = WAHLWEISE	X = SEE SEPARATE PARTS LIST WW. = OPTIONAL

POS. NR. POS. NO.	MATERIAL-NR. PART NUMBER	BEZEICHNUNG DESCRIPTION	POS. NR. POS. NO.	MATERIAL-NR. PART NUMBER	BEZEICHNUNG DESCRIPTION
C 34026	845296706400	ELKO 1000UF +50-20% 10V	CIC 80910	830581409400	SMD IC MC14094BD
C 40557	845299610700	ELKO 2200UF 20% 16V	CIC 80930	830595012900	SMD IC ST92R195C9Q1
C 50047	845299618700	ELKO 1000UF 20% 35V	CIC 82501	830596000800	SMD IC M24C08CM1TR
C 50048	845299864700	ELKO 1000UF 20% 25V			
C 53002	851591111400	FOKO KF #35 9000PF 3,5% 1500V	CL 40511	810498233100	SMD DAEMPF-PERLE 0805 BLM SMD DAMPING BEAD
C 54011	865006704600	KERKO HV C 100PF 20% 1KV			
C 54012	845299618700	ELKO 1000UF 20% 35V			
C 60501	865008112500	KERKO HV C 1000PF 20% 1KV	CT 32124	830100385800	SMD TRANS BC858B/BC857B
C 60509	851591104500	FOKO FKP1 680PF 10% 1600V	CT 34031	830100385800	SMD TRANS BC858B/BC857B
C 60512	865008111100	KERKO HV C 270PF 20% 2KV	CT 40581	830100385800	SMD TRANS BC858B/BC857B
C 60523	865008112500	KERKO HV C 1000PF 20% 1KV	CT 43010	830100385800	SMD TRANS BC858B/BC857B
C 60524	865008112500	KERKO HV C 1000PF 20% 1KV	CT 43015	830100484800	SMD TRANS BC848B/BC847B
C 60526	865008112500	KERKO HV C 1000PF 20% 1KV	CT 50005	830100484800	SMD TRANS BC848B/BC847B
C 60527	865008112500	KERKO HV C 1000PF 20% 1KV	CT 50015	830100484800	SMD TRANS BC848B/BC847B
C 61016	851591104000	FOKO FKP1 2200PF 10% 1600V	CT 50040	830100484800	SMD TRANS BC848B/BC847B
C 61036	865006704600	KERKO HV C 100PF 20% 1KV	CT 50050	830100484800	SMD TRANS BC848B/BC847B
C 61056	865006704600	KERKO HV C 100PF 20% 1KV	CT 50055	830100484800	SMD TRANS BC848B/BC847B
C 62501	851179301800	FOKO MP3 0,1UF 20% 275V	CT 52260	830100385800	SMD TRANS BC858B/BC857B
C 62521	866009623800	KERKO SI 2200PF 20% 400V	CT 57020	830100385800	SMD TRANS BC858B/BC857B
C 62522	866009623800	KERKO SI 2200PF 20% 400V	CT 57021	830100385800	SMD TRANS BC858B/BC857B
C 62549	866009623400	KERKO SI 1000PF 20% 400V	CT 57112	830100385800	SMD TRANS BC858B/BC857B
C 81063	814054010400	EMIFIL 0,1 UF -GR	CT 57113	830100385800	SMD TRANS BC858B/BC857B
CD 80501	830940159200	SMD DIODE BA591	CT 57124	830100484800	SMD TRANS BC848B/BC847B
			CT 61043	830100484800	SMD TRANS BC848B/BC847B

ÄNDERUNGEN VORBEHALTEN / SUBJECT TO ALTERATION

GRUNDIG

TV

POS. NR. POS. NO.	MATERIAL-NR. PART NUMBER	BEZEICHNUNG DESCRIPTION	POS. NR. POS. NO.	MATERIAL-NR. PART NUMBER	BEZEICHNUNG DESCRIPTION
CT 61053	830100484800	SMD TRANS BC848B/BC847B	L 81061	810498205100	FERRITPERLE HF55 BTL 3,5X FERRITE BEAD
CT 81220	830100484800	SMD TRANS BC848B/BC847B	L 81062	814052636100	DR 0411 10UH 5%
CT 81225	830100484800	SMD TRANS BC848B/BC847B	L 81064	814052636100	DR 0411 10UH 5% CHOKE
CT 85502	830100385800	SMD TRANS BC858B/BC857B			
D 40584	830921504500	DIODE 1N4148	Q 34043	838212104400	QUARZ 4,433619MHZ
D 40586	830921504500	DIODE 1N4148	Q 34044	838204900300	QUARZ 3,579545MHZ
D 43055	830921504500	DIODE 1N4148	Q 80001	838208004000	QUARZ 4MHZ
D 43056	830921504500	DIODE 1N4148	Q 80951	838216204100	QUARZ 4MHZ
D 50023	830921502000	DIODE 1N4004			
D 50048	830970301400	Z-DIODE ZPY5,6 2%	R 40551	873229240700	DRW 4 1,8 OHM 10%
D 52001	830921504500	DIODE 1N4148	R 43006	870001124600	KSW 0204 75 OHM 5%
D 53003	830920100500	DIODE BA157	R 50047	876642460200	MSW 0207 1,1 OHM 1%
D 54001	830920426800	DIODE BYV16	R 50048	870552103300	MOW 0411 22 OHM 5%
D 54011	830920100500	DIODE BA157	R 50050	870522705300	MOW 0411 150 OHM 5%
D 54022	830927033000	Z-DIODE 30B 0,5W	R 52004	870552105300	MOW 0411 150 OHM 5%
D 57013	830921504500	DIODE 1N4148	R 53002	870042909700	KSW NB 0207 10 KOHM 5%
D 57023	830921504500	DIODE 1N4148	R 53009	871033814500	MOW AX 1 MOHM 5%
D 60506	830951685400	DIODE BYT54M	R 53011	870552102100	MOW 0411 6,8 OHM 5%
D 60509	830966318000	Z-DIODE BZT03D180	R 53016	873018942500	DRW 9 10 OHM 10%
D 60512	830951675400	DIODE BYT53B	R 53021	870522707100	MOW 0411 820 OHM 5%
D 60523	830856038400	GLR.SKB380C1500	R 53033	870552100500	MOW 0411 1,5 OHM 5%
D 61016	830951717800	DIODE BYW178	R 53074	870556107100	MOW 0617 820 OHM 5%
D 61036	830951710800	DIODE BYT108-400	R 54001	870552102500	MOW 0411 2,2 OHM 5%
D 61056	830951717200	DIODE BYW172D	R 54006	870552100900	MOW 0411 2,2 OHM 5%
D 85001	830994460100	LE DIODE TLHR4601	R 54022	870556111100	MOW 0617 39 KOHM 5%
F 32109	860275654200	KERTRAP #542 6MHZ	R 60502	870006935600	KSW 0617 3 MOHM 2%
F 32410	814110760100	SPULE 7X7 #601 SIGN107601	R 60504	870006934700	KSW 0617 1,2 MOHM 2%
F 32412	831900198000	OPFWIL J190 SIE	R 60508	870556110500	MOW 0617 22 KOHM 5%
F 34052	814111675000	FILTER 7X7 #750 SIGN11675	R 60509	870556110500	MOW 0617 22 KOHM 5%
IC 34015	830512524800	IC STV2248	R 60516	879005004600	ESTR.SK10-A 4,7 KOHM LIN
IC 40550	830534726600	IC TDA7266B	R 61018	870552111900	MOW 0411 82 KOHM 5%
IC 50010	830533817500	IC TDA8174AW	R 62501	831120001600	PTC DUO T251-A80-A10
IC 60510	830533464600	IC TDA16846	R 62502	831100501700	NTC 4,7 OHM 30%
IC 61040	830520431700	IC LM317T	R 62549	876504916100	MSW SI 0414 4,7 MOHM
IC 61050	830520431700	IC LM317T	SI 40551	831561902800	SI LOET T1,6A 250V
IC 61060	830520570300	IC MC7805CT	SI 62501	831561700600	SI 5X20 T2,5A L 250V
IC 80500	830521006500	IC MC33164P-5RP	T 52001	830328563700	TRANS BC637
IC 80920	297980320100	IC 27C020 PROG.KPL	T 53001	830290002000	TRANS S2055N
IC 81500	293052194200	PROZESSORPLATTE	T 60506	830280504000	TRANS IRFBC40
WW.	830415513200	IC ST92195C9B1-S252			
IC 84501	830546133000	IC TSOP1330	TR52001	092468680400	TRAFO TREIBER TRANSFORMER DRIVER
L 31043	814052644000	DR ST 0411-GRP 8,2UH 10%	TR53010	292210315700	TRAFO DIODEN-SPLIT
L 32023	814052653000	DR 0411 33UH 10%	WW.	292016651101	TRAFO DIODEN-SPLIT TRANSFORMER DIODE SPLIT
L 32026	814052653000	DR 0411 33UH 10%	TR61000	292015219703	SPERRWANDLERTRAFO B.O.TYPE CONVERTER TRANSFORMER
L 32109	814052690600	DR 0309 4,7UH 10%			
L 40512	814050525900	DR A AX-GA 27UH 10%			
L 52251	814051174900	DR AX 0411-GA 10UH 10%			
L 52256	814052632000	DR AX 0411-GA 3,3UH 10% CHOKE			
L 53003	810498205600	FERRITPERLE HF70 BTL 3,5X FERRITE BEAD			
L 53011	814050524900	DR A AX-GA 10UH 10% CHOKE			
L 53021	292031149500	LINEARITAETSREGLER LINEARITY CONTROL			
L 53074	092468700101	ZB-SPULE ZB COIL			
L 60506	810498205700	FERRITPERLE 3,6UH 5720500			
L 61038	810498200300	FERRITPERLE BL02RN2-R62 FERRITE BEAD			
L 62501	295008269700	FUNKENTSTOERDROSSEL INTERFERENCE CHOKE			

Es gelten die Vorschriften und Sicherheitshinweise gemäß dem Service Manual "Sicherheit", Mat.-Nummer 720108000000, sowie zusätzlich die eventuell abweichenden, landesspezifischen Vorschriften!



The regulations and safety instructions shall be valid as provided by the "Safety" Service Manual, part number 720108000000, as well as the respective national deviations.

ÄNDERUNGEN VORBEHALTEN / SUBJECT TO ALTERATION

Ersatzteilliste Spare Parts List

1 / 2002

CHASSIS-FS-STEREO CUC 2121 MUL/DOLBY CHASSIS TV STEREO CUC 2121 MUL/DOLBY

MATERIAL-NR. / PART NO.: 297040137300

POS. NR. POS. NO.	ABB. FIG.	MATERIAL-NR. PART NUMBER	ANZ. QTY.	BEZEICHNUNG (D)	DESCRIPTION (GB)
		297040137300		CHASSIS-FS-STEREO CUC 2121 MUL/DOLBY KEIN E-TEIL	CHASSIS TV STEREO CUC 2121 MUL/DOLBY NO SPARE PART
0100.000		295045010100		TUNER-PLL STEHEND	TUNER-PLL TOP ENTRY
0216.000		297033571100		TASTSCHALTER PROGRAMM+	KEY SWITCH PROGRAMME+
0216.000		297033571100		TASTSCHALTER PROGRAMM-	KEY SWITCH PROGRAMME-
0216.000		297033571100		TASTSCHALTER LAUTSTAERKE+	KEY SWITCH VOLUME+
0216.000		297033571100		TASTSCHALTER LAUTSTAERKE-	KEY SWITCH VOLUME-
0240.000		293033904200		KOPFHÖRERBUCHSE 3,5 O.SCHALTER	HEADPHONE SOCKET 3,5 W/O SWITCH
0241.000		293031680503		CINCH-BUCHSE 3-FACH FBAS/NF L,R	CINCH SOCKET 3 FOLD FBAS/AF L,R
0247.000		293031190603		EURO-AV BUCHSENLEISTE 21-POL SW	EURO-AV SOCKET STRIP 21 P BLACK
0312.000		297006430104		ABDECKUNG EURO-AV	COVER EURO AV
0500.000		295041028400		STEREO MODULE	STEREO MODULE
0910.000	△	292107030100	X	FOKUSLEITUNG	FOCUSING CABLE
1000.000	△	096211130206	2	SICHERUNGSHALTER SI62501	FUSE HOLDER SI62501
2000.000	△	297033910600		NETZSCHALTER O.WISCHER	POWER SWITCH W/O WIPER
2200.000	△	293033995100		NETZ EINBAUGERÄTESTECKER	APPLIANCE COUPLER W.CABLE
2400.000		293031530107		MONTAGECLIP IC40550	MOUNTING CLIP IC40550
2410.000		293031530208	2	MONTAGECLIP IC50010/T53001	MOUNTING CLIP IC50010/T53001
2420.000		293031531600		MONTAGECLIP T60506	MOUNTING CLIP T60506
2430.000		293031531605	3	MONTAGECLIP IC61040/61050/61060	MOUNTING CLIP IC61040/61050/61060
2450.000		293031562000	4	FOLIE WAERMELEITEND	FOIL HEAT CONDUCTING
				IC61040/61050/61060/T60506	IC61040/61050/61060/T60506
				WW.=WAHLWEISE	WW.=OPTIONAL

POS. NR. POS. NO.	MATERIAL-NR. PART NUMBER	BEZEICHNUNG DESCRIPTION	POS. NR. POS. NO.	MATERIAL-NR. PART NUMBER	BEZEICHNUNG DESCRIPTION
C 34026	845296706400	ELKO 1000UF +50-20% 10V	CD 32411	830940159200	SMD DIODE BA591/BA592/BA782S
C 40557	845299610700	ELKO 2200UF 20% 16V	CD 32460	830940159200	SMD DIODE BA591/BA592/BA782S
C 50047	845299618700	ELKO 1000UF 20% 35V	CD 32470	830940159200	SMD DIODE BA591/BA592/BA782S
C 50048	845299864700	ELKO 1000UF 20% 25V	CD 34041	830940159200	SMD DIODE BA591/BA592/BA782S
C 83002	851591111400	FOKO KF #35 9000PF 3,5% 1500V	CD 80501	830940159200	SMD DIODE BA591/BA592/BA782S
C 84011	865006704600	KERKO HV C 100PF 20% 1KV	CIC 80910	830581409400	SMD IC MC14094BD
C 84012	845299618700	ELKO 1000UF 20% 35V	CIC 80930	830595012900	SMD IC ST92R195C9Q1
C 60501	865008112500	KERKO HV C 1000PF 20% 1KV	CIC 82501	830596008000	SMD IC M24C08CM1TR
C 60509	851591104500	FOKO FKP1 680PF 10% 1600V	CL 40511	810498233100	SMD DAEMPF-PERLE 0805
C 60512	865008111100	KERKO HV C 270PF 20% 2KV	CT 32111	830100484800	SMD TRANS BC848B/ BC847B
C 60523	865008112500	KERKO HV C 1000PF 20% 1KV	CT 32122	830100385800	SMD TRANS BC858B/ BC857B
C 60524	865008112500	KERKO HV C 1000PF 20% 1KV	CT 32123	830100484800	SMD TRANS BC848B/ BC847B
C 60526	865008112500	KERKO HV C 1000PF 20% 1KV	CT 32124	830100385800	SMD TRANS BC858B/ BC857B
C 60527	865008112500	KERKO HV C 1000PF 20% 1KV	CT 32132	830100484800	SMD TRANS BC848B/ BC847B
C 60528	845209711500	ELKO SNT #40 150UF 385V/400V	CT 32460	830100484800	SMD TRANS BC848B/ BC847B
WW.	845199711500	ELKO 19 150UF 385V	CT 32470	830100484800	SMD TRANS BC848B/ BC847B
C 61016	851591104000	FOKO FKP1 220PF 10% 1600V	CT 32480	830100484800	SMD TRANS BC848B/ BC847B
C 61036	865006704600	KERKO HV C 100PF 20% 1KV	CT 34031	830100385800	SMD TRANS BC858B/ BC857B
C 61056	865006704600	KERKO HV C 100PF 20% 1KV	CT 40581	830100385800	SMD TRANS BC858B/ BC857B
C 62501 △	851179301800	FOKO MP3 0,1UF 20% 275VW	CT 43010	830100385800	SMD TRANS BC858B/ BC857B
C 62521 △	866009623800	KERKO SI 2200PF 20%	CT 43015	830100484800	SMD TRANS BC848B/ BC847B
C 62522 △	866009623800	KERKO SI 2200PF 20%			
C 62549 △	866009623400	KERKO SI 1000PF 20%			
C 81063	814054010400	EMIFIL 0,1 UF			

ÄNDERUNGEN VORBEHALTEN / SUBJECT TO ALTERATION

POS. NR. POS. NO.	MATERIAL-NR. PART NUMBER	BEZEICHNUNG DESCRIPTION	POS. NR. POS. NO.	MATERIAL-NR. PART NUMBER	BEZEICHNUNG DESCRIPTION
CT 50005	830100484800	SMD TRANS BC848B/ BC847B	L 53011	814050524900	DR A AX-GA 10UH 10%
CT 50015	830100484800	SMD TRANS BC848B/ BC847B	L 53021	292031149500	LINEARITAETSREGLER
CT 50040	830100484800	SMD TRANS BC848B/ BC847B			LINEARITY CONTROL
CT 50050	830100484800	SMD TRANS BC848B/ BC847B	L 53074	092468700101	ZB-SPULE/ZB COIL
CT 50055	830100484800	SMD TRANS BC848B/ BC847B	L 60506	810498205700	FERRITPERLE 3,6UH
CT 52260	830100385800	SMD TRANS BC858B/ BC857B	L 61038	810498200300	FERRITPERLE BL02RN2-R62
CT 57020	830100385800	SMD TRANS BC858B/ BC857B			FERRITE BEAD
CT 57021	830100385800	SMD TRANS BC858B/ BC857B	L 62501 △	295008269700	FUNKENTSTOERDROSSEL RK19
CT 57112	830100385800	SMD TRANS BC858B/ BC857B			INTERFERENCE SUPPR. CHOKE
CT 57113	830100385800	SMD TRANS BC858B/ BC857B	L 81061	810498205100	FERRITPERLE HF55 BTL 3,5X4,5
CT 57124	830100484800	SMD TRANS BC848B/ BC847B			FERRITE BEAD
CT 61043	830100484800	SMD TRANS BC848B/ BC847B	L 81062	814052636100	DR 0411 10UH 5%
CT 61053	830100484800	SMD TRANS BC848B/ BC847B	L 81064	814052636100	DR 0411 10UH 5%
CT 81220	830100484800	SMD TRANS BC848B/ BC847B			
CT 81225	830100484800	SMD TRANS BC848B/ BC847B	Q 34043	838212104400	QUARZ 4,433619 MHZ
CT 85502	830100385800	SMD TRANS BC858B/ BC857B	Q 34044	838204900300	QUARZ 3,579545MHZ
			Q 80001	838208004000	QUARZ 4 MHZ
			Q 80951	838216204100	QUARZ 4 MHZ
D 40584	830921504500	DIODE 1N4148	R 40551	873229240700	DRW 4 1,8 OHM 10%
D 40586	830921504500	DIODE 1N4148	R 43006	870001124600	KSW 0204 75 OHM 5%
D 43055	830921504500	DIODE 1N4148	R 50047	876642460200	MSW 0207 1,1 OHM 1% ST
D 43056	830921504500	DIODE 1N4148	R 50048 △	870552103300	MOW 0411 22 OHM 5% LI
D 50023	830921502000	DIODE 1N4004	R 50050 △	870522705300	MOW 0411 22 OHM 5% LI
D 50048	830970301400	Z-DIODE ZPZY5,6 2%	R 52004 △	870552105300	MOW 0411 150 OHM 5% LI
D 52001	830921504500	DIODE 1N4148	R 53002 △	870042909700	KSW NB 0207 10 KOHM 5% ST
D 53003	830920100500	DIODE BA157	R 53009	871033814500	MGW AX 1 MOHM 5%
D 54001	830920426800	DIODE BYV16	R 53011 △	870552102100	MOW 0411 6,8 OHM 5% LI
D 54011	830920100500	DIODE BA157	R 53016	873018942500	DRW 9 10 OHM 10%
D 54022	830972033000	Z-DIODE 30 B 0,5W	R 53021 △	870522707100	MOW 0411 820 OHM 5%
D 57013	830921504500	DIODE 1N4148	R 53033 △	870552100500	MOW 0411 1,5 OHM 5% LI
D 57023	830921504500	DIODE 1N4148	R 53074 △	870556107100	MOW 0617 820 OHM 5% LI
D 60506 △	830951685400	DIODE BYT 54 M	R 54001 △	870552102500	MOW 0411 2,2 OHM 5% LI
D 60509 △	830966318000	Z-DIODE BZT03D180	R 54006 △	870552100900	MOW 0411 2,2 OHM 5% LI
D 60512	830951675400	DIODE BYT53B	R 54022 △	870556111100	MOW 0411 39 KOHM 5% LI
D 60523	830856038400	GLR.SKB380C1500	R 60502	870006935600	KSW 0617 3 MOHM 2%
D 61016 △	830951717800	DIODE BYW178	R 60504	870006934700	KSW 0617 1,2 MOHM 2%
D 61037 △	830951710800	DIODE BYT108-400	R 60508 △	870556110500	MOW 0617 22 KOHM 5% LI
D 61056 △	830951717200	DIODE BYW172D	R 60509 △	870556110500	MOW 0617 22 KOHM 5% LI
D 85511	830994460100	LE DIODE TLHR 4601	R 60516	879005004600	ESTR.SK10-A 4,7 KOHM LIN
F 32109	860275506600	KERTRAP #66 5,5/6/6,5MHZ	R 61018 △	870552111900	MOW 0411 82 KOHM 5% LI
F 32121	814111360000	FILTER 7X7 360	R 62501 △	831120001600	PTC DUO T251-A80-A10
F 32410	814053445100	SPULE 7X7 #451	R 62502	831100501700	NTC 4,7 OHM 30%
F 32412	831900395300	OFWFL K3953M	R 62549 △	876504916100	MSW SI 0414 4,7 MOHM VDE
F 32430	831900465400	OFWFL K4654K			
F 34052	814111675000	FILTER 7X7 #750	SI 40551 △	831561902800	SI LOET T1,6A 250V
			SI 62501 △	831561700600	SI 5X20 T2,5A L 250V
IC 34015	830512524800	IC STV2248	T 52001	830328563700	TRANS.BC 637
IC 40550	830534726600	IC TDA7266B	T 53001	830290002000	TRANS S2055M BU508DF
IC 50010	830533817500	IC TDA8174AW	T 60506	830280504000	TRANS.IRF BC 40 IOR ZNG.2
IC 60510	830533464600	IC TDA16846	TR 52001	092468880400	TRAFO TREIBER
IC 61040	830520431700	IC LM317T	TR 53010 △	292210315700	TRAFO DIODEN-SPLIT KPL
IC 61050	830520431700	IC LM317T	TR 53020 △	292016651101	DIODE SPLIT TRANSFORMER CPL
IC 61060	830520570300	IC MC7805CT	TR 53020 △	292016651101	DIODE SPLIT TRANSFORMER
IC 80500	830521006500	IC MC33164P-5RP	TR 61000 △	292015219703	SPERRWANDLERTRAFO
IC 80920	297980320100	IC 27C020 PROG.KPL			REVERSE CONVERTER
IC 81500	293052194200	PROZESSORPLATTE			
WW.	830415513200	IC ST92195C9B1-S252			
IC 84501	830546133000	IC TSOP1330			
L 31043	814052644000	DR ST 0411-GRP 8,2UH 10%			
L 32109	814052690600	DR 0309 4,7UH 10% ST			
L 40512	814050525900	DR A AX-GA 27UH 10%			
L 52251	814051174900	DR AX 0411-GA 10UH 10%			
L 52256	814052632000	DR AX 0411-GA 3,3UH 10%			
L 53003	810498205600	FERRITPERLE HF70 BTL 3,5X6			
		FERRITE BEAD			

Es gelten die Vorschriften und Sicherheitshinweise gemäß dem Service Manual "Sicherheit", Mat.-Nummer 720108000000, sowie zusätzlich die eventuell abweichenden, landesspezifischen Vorschriften!



The regulations and safety instructions shall be valid as provided by the "Safety" Service Manual, part number 720108000000, as well as the respective national deviations.

ÄNDERUNGEN VORBEHALTEN / SUBJECT TO ALTERATION

Ersatzteilliste
Spare Parts List

1 / 2002

CHASSIS-FS-STEREO CUC 2121 MUL/DOLBY
CHASSIS TV STEREO CUC 2121 MUL/DOLBY

MATERIAL-NR. / PART NO.: 297040137400

POS. NR. POS. NO.	ABB. FIG.	MATERIAL-NR. PART NUMBER	ANZ. QTY.	BEZEICHNUNG ①	DESCRIPTION ②
		297040137400		CHASSIS-FS-STEREO CUC 2121 MUL/DOLBY KEIN E-TEIL	CHASSIS TV STEREO CUC 2121 MUL/DOLBY NO SPARE PART
0100.000		295045010100		TUNER-PLL STEHEND	TUNER-PLL TOP ENTRY
0216.000		297033571100		TASTSCHALTER PROGRAMM+	KEY SWITCH PROGRAMME+
0216.000		297033571100		TASTSCHALTER PROGRAMM-	KEY SWITCH PROGRAMME-
0216.000		297033571100		TASTSCHALTER LAUTSTAERKE+	KEY SWITCH VOLUME+
0216.000		297033571100		TASTSCHALTER LAUTSTAERKE-	KEY SWITCH VOLUME-
0240.000		293033904200		KOPFHÖRERBUCHSE 3,5 O.SCHALTER	HEADPHONE SOCKET 3,5 W/O SWITCH
0241.000		293031180503		CINCH-BUCHSE 3-FACH FBAS/NF L,R	CINCH SOCKET 3 FOLD FBAS/NF L,R
0247.000		293031196603		EURO-AV BUCHSENLEISTE 21-POL SW	EURO-AV SOCKET STRIP 21 P BLACK
0312.000		297006430104		ABDECKUNG EURO-AV	COVER EURO AV
0500.000		295041028400	X	BAUSTEIN STEREO MODUL	STEREO MODULE
0910.000	△	292107030100		FOKUSLEITUNG	FOCUSING CABLE
1000.000	△	096211130206	2	SICHERUNGSHALTER SI62501	FUSE HOLDER SI62501
2000.000	△	297033910600		NETZSCHALTER O.WISCHER	POWER SWITCH W/O WIPER
2200.000	△	293033995100		NETZ EINBAUGERÄTESTECKER	APPLIANCE COUPLER W.CABLE
2400.000		293031530107		MONTAGECLIP IC40550	MOUNTING CLIP IC40550
2410.000		293031530208	2	MONTAGECLIP IC50010/T53001	MOUNTING CLIP IC50010/T53001
2420.000		293031531600		MONTAGECLIP T60506	MOUNTING CLIP T60506
2430.000		293031531605	3	MONTAGECLIP IC61040/61050/61060	MOUNTING CLIP IC61040/61050/61060
2450.000		293031562000	4	FOLIE WAERMELEITEND	FOIL HEAT CONDUCTING
				IC61040/61050/61060/T60506	IC61040/61050/61060/T60506
				WW.=WAHLWEISE	WW.=OPTIONAL
				X = SIEHE GESONDERTE E-LISTE	X = SEE SEPARATE PARTS LIST

POS. NR. POS. NO.	MATERIAL-NR. PART NUMBER	BEZEICHNUNG DESCRIPTION	POS. NR. POS. NO.	MATERIAL-NR. PART NUMBER	BEZEICHNUNG DESCRIPTION
C 34026	845296706400	ELKO 1000UF +50-20% 10V	CD 32411	830940159200	SMD DIODE BA591/BA592/BA782S
C 40557	845299610700	ELKO 2200UF 20% 16V	CD 32460	830940159200	SMD DIODE BA591/BA592/BA782S
C 50047	845299618700	ELKO 1000UF 20% 35V	CD 32470	830940159200	SMD DIODE BA591/BA592/BA782S
C 50048	845299664700	ELKO 1000UF 20% 35V	CD 34041	830940159200	SMD DIODE BA591/BA592/BA782S
C 53002	851591111400	FOKO KF #35 9000PF 3,5% 1500V	CD 80501	830940159200	SMD DIODE BA591/BA592/BA782S
C 54011	865006704600	KERKO HV C 100PF 20% 1KV	CIC 80910	830581409400	SMD IC MC14094BD
C 54012	845299618700	ELKO 1000UF 20% 35V	CIC 80930	830595012900	SMD IC ST92R195C9Q1
C 60501	865008112500	KERKO HV C 1000PF 20% 1KV	CIC 82501	830596000800	SMD IC M24C08CM1TR
C 60509	851591104500	FOKO FKP1 680PF 10% 1600V			
C 60512	865008111100	KERKO HV C 270PF 20% 2KV	CL 40511	810498233100	SMD DAEMPF-PERLE 0805
C 60523	865008112500	KERKO HV C 1000PF 20% 1KV	CT 32111	830100484800	SMD TRANS BC848B/ BC847B
C 60524	865008112500	KERKO HV C 1000PF 20% 1KV	CT 32122	830100385800	SMD TRANS BC858B/ BC857B
C 60526	865008112500	KERKO HV C 1000PF 20% 1KV	CT 32123	830100484800	SMD TRANS BC848B/ BC847B
C 60527	865008112500	KERKO HV C 1000PF 20% 1KV	CT 32124	830100385800	SMD TRANS BC858B/ BC857B
C 60528	845209711500	ELKO SNT #40 150UF 385V/400V	CT 32132	830100484800	SMD TRANS BC848B/ BC847B
WW.	845199711500	ELKO 19 150UF 385V	CT 32134	830100385800	SMD TRANS BC858B/ BC857B
C 61016	851591104000	FOKO FKP1 220PF 10% 1600V	CT 32136	830100484800	SMD TRANS BC848B/ BC847B
C 61036	865006704600	KERKO HV C 100PF 20% 1KV	CT 32460	830100484800	SMD TRANS BC848B/ BC847B
C 61056	865006704600	KERKO HV C 100PF 20% 1KV	CT 32470	830100484800	SMD TRANS BC848B/ BC847B
C 62501 △	851179301800	FOKO MP3 0,1UF 20% 275VW	CT 32480	830100484800	SMD TRANS BC848B/ BC847B
C 62521 △	866009623800	KERKO SI 2200PF 20%	CT 34031	830100385800	SMD TRANS BC858B/ BC857B
C 62522 △	866009623800	KERKO SI 2200PF 20%	CT 40581	830100385800	SMD TRANS BC858B/ BC857B
C 62549 △	866009623400	KERKO SI 1000PF 20%	CT 43010	830100385800	SMD TRANS BC858B/ BC857B
C 81063	814054010400	EMIFIL 0,1 UF	CT 43015	830100484800	SMD TRANS BC848B/ BC847B

ÄNDERUNGEN VORBEHALTEN / SUBJECT TO ALTERATION

GRUNDIG

TV

POS. NR. POS. NO.	MATERIAL-NR. PART NUMBER	BEZEICHNUNG DESCRIPTION	POS. NR. POS. NO.	MATERIAL-NR. PART NUMBER	BEZEICHNUNG DESCRIPTION
CT 50005	830100484800	SMD TRANS BC848B/ BC847B	L 53011	814050524900	DR A AX-GA 10UH 10%
CT 50015	830100484800	SMD TRANS BC848B/ BC847B	L 53021	292031149500	LINEARITÄTSREGLER
CT 50040	830100484800	SMD TRANS BC848B/ BC847B			LINEARITY CONTROL
CT 50050	830100484800	SMD TRANS BC848B/ BC847B	L 53074	092468700101	ZB-SPULE/ZB COIL
CT 50055	830100484800	SMD TRANS BC848B/ BC847B	L 60506	810498205700	FERRITPERLE 3,6UH
CT 52260	830100385800	SMD TRANS BC858B/ BC857B	L 61038	810498200300	FERRITPERLE BL02RN2-R62
CT 57020	830100385800	SMD TRANS BC858B/ BC857B			FERRITE BEAD
CT 57021	830100385800	SMD TRANS BC858B/ BC857B	L 62501 △	295008269700	FUNKENTSTÖRERDROSSEL RK19
CT 57112	830100385800	SMD TRANS BC858B/ BC857B			INTERFERENCE SUPPR. CHOKE
CT 57113	830100385800	SMD TRANS BC858B/ BC857B	L 81061	810498205100	FERRITPERLE HF55 BTL 3,5X4,5
CT 57124	830100484800	SMD TRANS BC848B/ BC847B			FERRITE BEAD
CT 61043	830100484800	SMD TRANS BC848B/ BC847B	L 81062	814052636100	DR 0411 10UH 5%
CT 61053	830100484800	SMD TRANS BC848B/ BC847B	L 81064	814052636100	DR 0411 10UH 5%
CT 81220	830100484800	SMD TRANS BC848B/ BC847B			
CT 81225	830100484800	SMD TRANS BC848B/ BC847B	Q 34043	838212104400	QUARZ 4,433619 MHZ
CT 85502	830100385800	SMD TRANS BC858B/ BC857B	Q 34044	838204900300	QUARZ 3,579545MHZ
			Q 80001	838208004000	QUARZ 4 MHZ
			Q 80951	838216204100	QUARZ 4 MHZ
D 40584	830921504500	DIODE 1N4148	R 40551	873229240700	DRW 4 1,8 OHM 10%
D 40586	830921504500	DIODE 1N4148	R 43006	870001124600	KSW 0204 75 OHM 5%
D 43055	830921504500	DIODE 1N4148	R 50047	876642460200	MSW 0207 1,1 OHM 1% ST
D 43056	830921504500	DIODE 1N4148	R 50048 △	870552103300	MOW 0411 22 OHM 5% LI
D 50023	830921502000	DIODE 1N4004	R 50050 △	870522705300	MOW 0411 150 OHM 5% LI
D 50048	830970301400	Z-DIODE ZPY5,6 2%	R 52004 △	870552105300	MOW 0411 150 OHM 5% LI
D 52001	830921504500	DIODE 1N4148	R 53002 △	870042909700	KSW NB 0207 10 KOHM 5% ST
D 53003	830920100500	DIODE BA157	R 53009	871033814500	MGW AX 1 MOHM 5%
D 54001	830920426800	DIODE BYV16	R 53011 △	870552102100	MOW 0411 6,8 OHM 5% LI
D 54011	830920100500	DIODE BA157	R 53016	873018942500	DRW 9 10 OHM 10%
D 54022	830927033000	Z-DIODE 30 B 0,5W	R 53021 △	870522707100	MOW 0411 820 OHM 5%
D 57013	830921504500	DIODE 1N4148	R 53033 △	870552098500	MOW 0411 0,22 OHM 5% LI
D 57023	830921504500	DIODE 1N4148	R 53074 △	870556107100	MOW 0617 820 OHM 5% LI
D 60506 △	830951685400	DIODE BYT 54 M	R 54001 △	870552102500	MOW 0411 10 OHM 5% LI
D 60509 △	830966318000	Z-DIODE BZT03D180	R 54006 △	870552100900	MOW 0411 2,2 OHM 5% LI
D 60512	830951675400	DIODE BYT53B	R 54022 △	870556111100	MOW 0617 39 KOHM 5% LI
D 60523	830856038400	GLR.SKB380C1500	R 60502	870006935600	KSW 0617 3 MOHM 2%
D 61016 △	830951717800	DIODE BYW178	R 60504	870006934700	KSW 0617 1,2 MOHM 2%
D 61037 △	830951710800	DIODE BYT108-400	R 60508 △	870556110500	MOW 0617 22 KOHM 5% LI
D 61056 △	830951717200	DIODE BYW172R	R 60509 △	870556110500	MOW 0617 22 KOHM 5% LI
D 85511	830994460100	LE DIODE TLHD 4601	R 60516	879005004600	ESTR.SK10-A 4,7 KOHM LI
F 32109	860275506600	KERTRAP #66 5,5/6,5MHZ	R 61018 △	870552111900	MOW 0411 82 KOHM 5% LI
F 32121	814111136000	FILTER 7X7 360	R 62501 △	831120001800	PTC DUO B59709-T60-A110
F 32410	814053445100	SPULE 7X7 #451	R 62502	831100501700	NTC 4,7 OHM 30%
F 32412	831900395300	OFWFIL K3953M	R 62549 △	876504916100	MSW SI 0414 4,7 MOHM VDE
F 32430	831900465400	OFWFIL K4654K	SI 40551 △	831561902800	SI LOET T1,6A 250V
F 34052	814111675000	FILTER 7X7 #750	SI 62501 △	831561700600	SI 5X20 T2,5A L 250V
IC 34015	830512524800	IC STV2248	T 52001	830328563700	TRANS.BC 637
IC 40550	830534726600	IC TDA7266B	T 53001	830290002000	TRANS S2055N/ BU508DF
IC 50010	830533817500	IC TDA8174AW	T 60506	830280504000	TRANS.IRF BC 40 IOR ZNG.2
IC 60510	830533464600	IC TDA16846	TR 52001	092468680400	TRAFO TREIBER
IC 61040	830520431700	IC LM317T			DRIVER TRANSFORMER
IC 61050	830520431700	IC LM317T	TR 53010 △	292210315700	TRAFO DIODEN-SPLIT KPL
IC 61060	830520570300	IC MC7805CT			DIODE SPLIT TRANSFORMER CPL
IC 80500	830521006500	IC MC33164P-5RP	TR 53020 △	292016651101	DIODEN-SPLIT TRAFO
IC 80920	297980320100	IC 27C020 PROG.KPL			DIODE SPLIT TRANSFORMER
IC 81500	293052194200	PROZESSORPLATTE	TR 61000 △	292015219703	SPERRWANDLERTRAFO
WW.	830415513200	IC ST92195C9B1-S252			REVERSE CONVERTER
IC 84501	830546133000	IC TSOP1330			TRANSFORMER
L 31043	814052644000	DR ST 0411-GRP 8,2UH 10%			
L 32109	814052696000	DR 0309 4,7UH 10% ST			
L 40512	814050525900	DR A AX-GA 27UH 10%			
L 52251	814051174900	DR AX 0411-GA 10UH 10%			
L 52256	814052632000	DR AX 0411-GA 3,3UH 10%			
L 53003	810498205600	FERRITPERLE HF70 BTL 3,5X6			
		FERRITE BEAD			

Es gelten die Vorschriften und Sicherheitshinweise gemäß dem Service Manual "Sicherheit", Mat.-Nummer 720108000000, sowie zusätzlich die eventuell abweichenden, landesspezifischen Vorschriften!



The regulations and safety instructions shall be valid as provided by the "Safety" Service Manual, part number 720108000000, as well as the respective national deviations.

ÄNDERUNGEN VORBEHALTEN / SUBJECT TO ALTERATION

Ersatzteilliste Spare Parts List

1 / 2002

GRUNDIG

TV

CHASSIS-FS-STEREO CUC 2121 MUL/DOLBY CHASSIS TV STEREO CUC 2121 MUL/DOLBY

MATERIAL-NR. / PART NO.: 297040137500

POS. NR. POS. NO.	ABB. FIG.	MATERIAL-NR. PART NUMBER	ANZ. QTY.	BEZEICHNUNG (D)	DESCRIPTION (GB)
		297040137500		CHASSIS-FS-STEREO CUC 2121 MUL/DOLBY KEIN E-TEIL	CHASSIS TV STEREO CUC 2121 MUL/DOLBY NO SPARE PART
0100.000		295045010100		TUNER-PLL STEHEND	TUNER-PLL TOP ENTRY
0216.000		297033571100		TASTSCHALTER PROGRAMM+	KEY SWITCH PROGRAMME+
0216.000		297033571100		TASTSCHALTER PROGRAMM-	KEY SWITCH PROGRAMME-
0216.000		297033571100		TASTSCHALTER LAUTSTAERKE+	KEY SWITCH VOLUME+
0216.000		297033571100		TASTSCHALTER LAUTSTAERKE-	KEY SWITCH VOLUME-
0240.000		293033904200		KOPFHUERERBUCHSE 3,5 O.SCHALTER	HEADPHONE SOCKET 3.5 W/O SWITCH
0241.000		293031680503		CINCH-BUCHSE 3-FACH FBAS/NF L,R	CINCH SOCKET 3 FOLD FBAS/AF L,R
0247.000		293031190603		EURO-AV BUCHSENLEISTE 21-POL SW	EURO-AV SOCKET STRIP 21 P BLACK
0312.000		297006430104		ABDECKUNG EURO-AV	COVER EURO AV
0500.000		295041028400		BLAUSTEIN STEREO MODUL	STEREO MODULE
0910.000	△	292107030100	X	FOKUSLEITUNG	FOCUSING CABLE
1000.000	△	096211130206	2	SICHERUNGSHALTER SI62501	FUSE HOLDER SI62501
2000.000	△	297033910600		NETZSCHALTER O.WISCHER	POWER SWITCH W/O WIPER
2200.000	△	293033995100		NETZ EINBAUGERAETESTECKER	APPLIANCE COUPLER W.CABLE
2400.000		293031530107		MONTAGECLIP IC40550	MOUNTING CLIP IC40550
2410.000		293031530208	2	MONTAGECLIP IC50010/T53001	MOUNTING CLIP IC50010/T53001
2420.000		293031531600		MONTAGECLIP T60506	MOUNTING CLIP T60506
2430.000		293031531605	3	MONTAGECLIP IC61040/61050/61060	MOUNTING CLIP IC61040/61050/61060
2450.000		293031562000	4	FOLIE WAERMELEITEND IC61040/61050/61060/T60506	FOIL HEAT CONDUCTING IC61040/61050/61060/T60506
				WW.=WAHLWEISE X = SIEHE GESONDERTE E-LISTE	WW.=OPTIONAL X = SEE SEPARATE PARTS LIST

POS. NR. POS. NO.	MATERIAL-NR. PART NUMBER	BEZEICHNUNG DESCRIPTION	POS. NR. POS. NO.	MATERIAL-NR. PART NUMBER	BEZEICHNUNG DESCRIPTION
C 34026	845296706400	ELKO 1000UF +50-20% 10V	CD 32411	830940159200	SMD DIODE BA591/BA592/BA782S
C 40557	845299610700	ELKO 2200UF 20% 16V	CD 32460	830940159200	SMD DIODE BA591/BA592/BA782S
C 50047	845299618700	ELKO 1000UF 20% 35V	CD 32470	830940159200	SMD DIODE BA591/BA592/BA782S
C 50048	845299664700	ELKO 1000UF 20% 25V	CD 34041	830940159200	SMD DIODE BA591/BA592/BA782S
C 53002	851591110200	FOKO FKP1/4 8500PF 3,5% 1500V	CD 80501	830940159200	SMD DIODE BA591/BA592/BA782S
C 54011	865006704600	KERKO HV C 1000PF 20% 1KV			
C 54012	845299618700	ELKO 1000UF 20% 35V	CIC 80910	830581409400	SMD IC MC14094BD
C 60501	865008112500	KERKO HV C 1000PF 20% 1KV	CIC 80930	830595012900	SMD IC ST92R195C9Q1
C 60509	851591104500	FOKO FKP1 680PF 10% 1600V	CIC 82501	830596000800	SMD IC M24C08CM1TR
C 60512	865008111100	KERKO HV C 270PF 20% 2KV			
C 60523	865008112500	KERKO HV C 1000PF 20% 1KV	CL 40511	810498233100	SMD DAEMPF-PERLE 0805
C 60524	865008112500	KERKO HV C 1000PF 20% 1KV			
C 60526	865008112500	KERKO HV C 1000PF 20% 1KV	CT 32111	830100484800	SMD TRANS BC848B/ BC847B
C 60527	865008112500	KERKO HV C 1000PF 20% 1KV	CT 32122	830100385800	SMD TRANS BC858B/ BC857B
C 60528	845209711500	ELKO SNT #40 150UF 385V/400V	CT 32123	830100484800	SMD TRANS BC848B/ BC847B
WW.	845199711500	ELKO 19 150UF 385V	CT 32124	830100385800	SMD TRANS BC858B/ BC857B
C 61016	851591104000	FOKO FKP1 220PF 10% 1600V	CT 32132	830100484800	SMD TRANS BC848B/ BC847B
C 61036	865006704600	KERKO HV C 1000PF 20% 1KV	CT 32460	830100484800	SMD TRANS BC848B/ BC847B
C 61056	865006704600	KERKO HV C 1000PF 20% 1KV	CT 32470	830100484800	SMD TRANS BC848B/ BC847B
C 62501	851179301800	FOKO MP3 0,1UF 20% 275VW	CT 32480	830100484800	SMD TRANS BC848B/ BC847B
C 62521	866009623800	KERKO SI 2200PF 20%	CT 34031	830100385800	SMD TRANS BC858B/ BC857B
C 62522	866009623800	KERKO SI 2200PF 20%	CT 40581	830100385800	SMD TRANS BC858B/ BC857B
C 62549	866009623400	KERKO SI 1000PF 20%	CT 43010	830100385800	SMD TRANS BC858B/ BC857B
C 81063	814054010400	EMIFIL 0,1 UF	CT 43015	830100484800	SMD TRANS BC848B/ BC847B

ÄNDERUNGEN VORBEHALTEN / SUBJECT TO ALTERATION

POS. NR. POS. NO.	MATERIAL-NR. PART NUMBER	BEZEICHNUNG DESCRIPTION	POS. NR. POS. NO.	MATERIAL-NR. PART NUMBER	BEZEICHNUNG DESCRIPTION
CT 50005	830100484800	SMD TRANS BC848B/ BC847B	L 53011	814050524900	DR A AX-GA 10UH 10%
CT 50015	830100484800	SMD TRANS BC848B/ BC847B	L 53021	292031149500	LINEARITAETSREGLER LINEARITY CONTROL
CT 50040	830100484800	SMD TRANS BC848B/ BC847B	L 53074	092468700101	ZB-SPULE/ZB COIL
CT 50055	830100484800	SMD TRANS BC848B/ BC847B	L 60506	810498205700	FERRITPERLE 3,6UH
CT 52260	830100385800	SMD TRANS BC858B/ BC857B	L 61038	810498200300	FERRITPERLE BL02RN2-R62 FERRITE BEAD
CT 57020	830100385800	SMD TRANS BC858B/ BC857B	L 62501	△ 295008269700	FUNKENTSTOERDROSSEL RK19 INTERFERENCE SUPPR. CHOKE
CT 57021	830100385800	SMD TRANS BC858B/ BC857B	L 81061	810498205100	FERRITPERLE HF55 BTL 3,5X4,5 FERRITE BEAD
CT 57112	830100385800	SMD TRANS BC858B/ BC857B	L 81062	814052636100	DR 0411 10UH 5%
CT 57113	830100385800	SMD TRANS BC858B/ BC857B	L 81064	814052636100	DR 0411 10UH 5%
CT 57124	830100484800	SMD TRANS BC848B/ BC847B			
CT 61043	830100484800	SMD TRANS BC848B/ BC847B			
CT 61053	830100484800	SMD TRANS BC848B/ BC847B			
CT 81220	830100484800	SMD TRANS BC848B/ BC847B			
CT 81225	830100484800	SMD TRANS BC848B/ BC847B	Q 34043	838212104400	QUARZ 4,433619 MHZ
CT 85502	830100385800	SMD TRANS BC858B/ BC857B	Q 34044	838204900300	QUARZ 3,579545MHZ
			Q 80001	838208004000	QUARZ 4 MHZ
			Q 80951	838216204100	QUARZ 4 MHZ
D 40584	830921504500	DIODE 1N4148	R 40551	873229240700	DRW 4 1,8 OHM 10%
D 40586	830921504500	DIODE 1N4148	R 43006	870001124600	KSW 0204 75 OHM 5%
D 43055	830921504500	DIODE 1N4148	R 50047	876642460200	MSW 0207 1,1 OHM 1% ST
D 43056	830921504500	DIODE 1N4148	R 50048	△ 870552103300	MOW 0411 22 OHM 5% LI
D 50023	830921502000	DIODE 1N4004	R 50050	△ 870522705300	MOW 0411 22 OHM 5% LI
D 50048	830970301400	Z-DIODE 2PZY5,6 2%	R 52004	△ 870552105300	MOW 0411 150 OHM 5% LI
D 52001	830921504500	DIODE 1N4148	R 53002	△ 870042909700	KSW NB 0207 10 KOHM 5% ST
D 53003	830920100500	DIODE BA157	R 53009	871033814500	MGW AX 1 MOHM 5%
D 54001	830920426800	DIODE BYV16	R 53011	△ 870552102100	MOW 0411 6,8 OHM 5% LI
D 54011	830920100500	DIODE BA157	R 53016	873018942500	DRW 9 10 OHM 10%
D 54022	830972033000	Z-DIODE 30 B 0,5W	R 53021	△ 870522707100	MOW 0411 820 OHM 5%
D 57013	830921504500	DIODE 1N4148	R 53033	△ 870552098500	MOW 0411 0,22 OHM 5% LI
D 57023	830921504500	DIODE 1N4148	R 53074	△ 870556107100	MOW 0617 820 OHM 5% LI
D 60506	△ 830951685400	DIODE BYT 54 M	R 54001	△ 870552102500	MOW 0411 2,2 OHM 5% LI
D 60509	△ 830966318000	Z-DIODE BZT03D180	R 54006	△ 870552100900	MOW 0411 2,2 OHM 5% LI
D 60512	830951675400	DIODE BYT53B	R 54022	△ 870556111100	MOW 0617 39 KOHM 5% LI
D 60523	830856038400	GLR.SKB380C1500	R 60502	870006935600	KSW 0617 3 MOHM 2%
D 61016	△ 830951717800	DIODE BYW178	R 60504	870006934700	KSW 0617 1,2 MOHM 2%
D 61037	△ 830951710800	DIODE BYW178-400	R 60508	△ 870556110500	MOW 0617 22 KOHM 5% LI
D 61056	△ 830951717200	DIODE BYW172D	R 60509	△ 870556110500	MOW 0617 22 KOHM 5% LI
D 85511	830994460100	LE DIODE TLHR 4601	R 60516	879005004600	ESTR.SK10-A 4,7 KOHM LIN
F 32109	860275506600	KERTRAP #66 5,5/6/6,5MHZ	R 61018	△ 870552119100	MOW 0411 82 KOHM 5% LI
F 32121	814111360000	FILTER 7X7 360	R 62501	△ 831120001800	PTC DUO B59709-T60-A110
F 32410	814053445100	SPULE 7X7 #451	R 62502	831100501700	NTC 4,7 OHM 30%
F 32412	831900395300	OFWFIL K3953M	R 62549	△ 876504916100	MSW SI 0414 4,7 MOHM VDE
F 32430	831900465400	OFWFIL K4654K			
F 34052	814111675000	FILTER 7X7 #750	SI 40551	△ 831561902800	SI LOET T1,6A 250V
IC 34015	830512524800	IC STV2248	SI 62501	△ 831561700600	SI 5X20 T2,5A L 250V
IC 40550	830534726600	IC TDA7266B	T 52001	830328563700	TRANS.BC 637
IC 50010	830533817500	IC TDA8174AW	T 53001	830290002000	TRANS S2055N/ BU508DF
IC 60510	830533464600	IC TDA16846	T 60506	830280504000	TRANS.IRF BC 40 IOR ZNG.2
IC 61040	830520431700	IC LM317T			
IC 61050	830520431700	IC LM317T	TR 52001	092468880400	TRAFO TREIBER DRIVER TRANSFORMER
IC 61060	830520570300	IC MC7805CT	TR 53010	△ 292210315700	TRAFO DIODEN-SPLIT KPL DIODE SPLIT TRANSFORMER CPL
IC 80500	830521006500	IC MC33164P-SRP	TR 53020	△ 292016651101	DIODE SPLIT TRANSFORMER DIODE SPLIT TRANSFORMER
IC 80920	297980320100	IC 27C020 PROG.KPL	TR 61000	△ 292015219703	SPERRWANDLERTRAFO REVERSE CONVERTER TRANSFORMER
IC 81500	293052194200	PROZESSORPLATTE			
WW.	830415513200	IC ST92195C9B1-S252			
IC 84501	8305446133000	IC TSOP1330			
L 31043	814052644000	DR ST 0411-GRP 8,2UH 10%			
L 32109	814052690600	DR 0309 4,7UH 10% ST			
L 40512	814050525900	DR A AX-GA 27UH 10%			
L 52251	814051174900	DR AX 0411-GA 10UH 10%			
L 52256	814052632000	DR AX 0411-GA 3,3UH 10%			
L 53003	810498205600	FERRITPERLE HF70 BTL 3,5X6 FERRITE BEAD			

Es gelten die Vorschriften und Sicherheitshinweise gemäß dem Service Manual "Sicherheit", Mat.-Nummer 720108000000, sowie zusätzlich die eventuell abweichenden, landesspezifischen Vorschriften!



The regulations and safety instructions shall be valid as provided by the "Safety" Service Manual, part number 720108000000, as well as the respective national deviations.

ÄNDERUNGEN VORBEHALTEN / SUBJECT TO ALTERATION

Ersatzteilliste
Spare Parts List

3 / 2002

CHASSIS-FS-STEREO CUC 2121 MULTI DOLBY
CHASSIS TV STEREO CUC 2121 MULTI DOLBY

MATERIAL-NR. / PART NO.: 297040137900

POS. NR. POS. NO.	ABB. FIG.	MATERIAL-NR. PART NUMBER	ANZ. QTY.	BEZEICHNUNG (D)	DESCRIPTION (GB)
		297040137900		CHASSIS-FS-STEREO CUC 2121 MULTI DOLBY KEIN E-TEIL	CHASSIS TV STEREO CUC 2121 MULTI DOLBY NO SPARE PART
0100.000		295045010100		TUNER-PLL STEHEND	TUNER-PLL TOP ENTRY
0215.000		297033571100		TASTSCHALTER PROGRAMM +	KEY SWITCH PROGRAMME +
0215.000		297033571100		TASTSCHALTER PROGRAMM -	KEY SWITCH PROGRAMME -
0215.000		297033571100		TASTSCHALTER LAUTSTAERKE +	KEY SWITCH VOLUME +
0215.000		297033571100		TASTSCHALTER LAUTSTAERKE -	KEY SWITCH VOLUME -
0240.000		293033904200		KOPFHOERERBUCHSE 3,5mm O.SCHALTER	HEADPHONE SOCKET 3,5mm W/O SWITCH
0241.000		293031680503		CINCH-BUCHSE 3-FACH FBAS/NF L,R	CINCH SOCKET 3 FOLD FBAS/AF L,R
0247.000		293031190603		EURO-AV BUCHSENLEISTE 21-POL SW	EURO-AV SOCKET STRIP 21 PIN BLACK
0312.000		297006430104		ABDECKUNG EURO AV	COVER EURO AV
0500.000		295041028400		BAUSTEIN STEREO	STEREO MODULE
0910.000	△	292107030100		FOKUSLEITUNG	FOCUSING CABLE
1000.000	△	096211130206	2	SICHERUNGSHALTER SI62501	FUSE HOLDER SI62501
2000.000	△	297033910600		NETZSCHALTER O.WISCHER	POWER SWITCH W/O WIPER
2200.000	△	293033995100		NETZ EINBAUGERAETESTECKER	APPLIANCE COUPLER
2400.000		293031530107		MONTAGECLIP IC40550	MOUNTING CLIP IC40550
2410.000		293031530208	2	MONTAGECLIP T53001/IC50010	MOUNTING CLIP T53001/IC50010
2440.000		293031531600		MONTAGECLIP T60506	MOUNTING CLIP T60506
2445.000		293031531605	3	MONTAGECLIP IC61040/61050/61060	MOUNTING CLIP IC61040/61050/61060
2470.000		293031562000	4	FOILIE WAERMELEITEND T60506/ IC61040/61050/61060	FOIL HEAT CONDUCTING T60506/ IC61040/61050/61060
				X = SIEHE GESONDERTE E-LISTE WW. = WAHLWEISE	X = SEE SEPARATE PARTS LIST WW. = OPTIONAL

POS. NR. POS. NO.	MATERIAL-NR. PART NUMBER	BEZEICHNUNG DESCRIPTION	POS. NR. POS. NO.	MATERIAL-NR. PART NUMBER	BEZEICHNUNG DESCRIPTION
C 34026	845296706400	ELKO 1000UF +50-20% 10V	CD 32460	830940159200	SMD DIODE BA591
C 40557	845299610700	ELKO 2200UF 20% 16V	CD 32470	830940159200	SMD DIODE BA591
C 50047	845299618700	ELKO 1000UF 20% 35V	CD 34041	830940159200	SMD DIODE BA591
C 50048	845299864700	ELKO 1000UF 20% 25V	CD 80501	830940159200	SMD DIODE BA591
C 53002	851591111400	FOKO KF #35 9000PF 3,5% 1500V			
C 54011	865006704600	KERKO HV C 100PF 20% 1KV	CIC 80910	830581409400	SMD IC MC14094BD
C 54012	845299618700	ELKO 1000UF 20% 35V	CIC 80930	830595012900	SMD IC ST92R195C9Q1
C 60501	865008112500	KERKO HV C 1000PF 20% 1K	CIC 82501	830596008000	SMD IC M24C08CM1TR
C 60509	851591104500	FOKO FKP1 680PF 10% 1600V			
C 60512	865008111100	KERKO HV C 270PF 20% 2KV	CL 40511	810498233100	SMD DAEMPF-PERLE 0805 BLM SMD DAMPING BEAD
C 60523	865008112500	KERKO HV C 1000PF 20% 1KV			
C 60524	865008112500	KERKO HV C 1000PF 20% 1KV			
C 60526	865008112500	KERKO HV C 1000PF 20% 1KV	CT 32111	830100484800	SMD TRANS BC848B/BC847B
C 60527	865008112500	KERKO HV C 1000PF 20% 1KV	CT 32122	830100385800	SMD TRANS BC858B/BC857B
C 61016	851591104000	FOKO FKP1 220PF 10% 1600V	CT 32123	830100484800	SMD TRANS BC848B/BC847B
C 61036	865006704600	KERKO HV C 100PF 20% 1KV	CT 32124	830100385800	SMD TRANS BC858B/BC857B
C 61056	865006704600	KERKO HV C 100PF 20% 1KV	CT 32132	830100484800	SMD TRANS BC848B/BC847B
C 62501	851179301800	FOKO MP3 0,1UF 20% 275V	CT 32460	830100484800	SMD TRANS BC848B/BC847B
C 62521	866009623800	KERKO SI 2200PF 20% 400V	CT 32470	830100484800	SMD TRANS BC848B/BC847B
C 62522	866009623800	KERKO SI 2200PF 20% 400V	CT 32480	830100484800	SMD TRANS BC848B/BC847B
C 62549	866009623400	KERKO SI 1000PF 20% 400V	CT 34031	830100385800	SMD TRANS BC858B/BC857B
C 81063	814054010400	EMIFIL 0,1 UF -GR	CT 40581	830100385800	SMD TRANS BC858B/BC857B
			CT 43010	830100385800	SMD TRANS BC858B/BC857B
CD 32411	830940159200	SMD DIODE BA591	CT 43015	830100484800	SMD TRANS BC848B/BC847B

GRUNDIG

TV

POS. NR. POS. NO.	MATERIAL-NR. PART NUMBER	BEZEICHNUNG DESCRIPTION	POS. NR. POS. NO.	MATERIAL-NR. PART NUMBER	BEZEICHNUNG DESCRIPTION
CT 50005	830100484800	SMD TRANS BC848B/BC847B	L 53003	810498205600	FERRITPERLE HF70 BTL 3,5X
CT 50015	830100484800	SMD TRANS BC848B/BC847B			FERRITE BEAD
CT 50040	830100484800	SMD TRANS BC848B/BC847B	L 53011	814050524900	DR A AX-GA 10UH 10% CHOKE
CT 50050	830100484800	SMD TRANS BC848B/BC847B	L 53021	292031149500	LINEARITAETSREGLER LINEARITY CONTROL
CT 50055	830100484800	SMD TRANS BC848B/BC847B	L 53074	092468700101	ZB-SPULE ZB COIL
CT 52260	830100385800	SMD TRANS BC858B/BC857B	L 60506	810498205700	FERRITPERLE 3,6UH 5720500
CT 57020	830100385800	SMD TRANS BC858B/BC857B	L 61038	810498200300	FERRITPERLE BL02RN2-R62 FERRITE BEAD
CT 57021	830100385800	SMD TRANS BC858B/BC857B	L 62501	△ 295008269700	FUNKENTSTOERDROSSEL INTERFERENCE CHOKE
CT 57112	830100385800	SMD TRANS BC858B/BC857B	L 81061	810498205100	FERRITPERLE HF55 BTL 3,5X FERRITE BEAD
CT 57113	830100385800	SMD TRANS BC858B/BC857B	L 81062	814052636100	DR 0411 10UH 5%
CT 57124	830100484800	SMD TRANS BC848B/BC847B	L 81064	814052636100	DR 0411 10UH 5% CHOKE
CT 61043	830100484800	SMD TRANS BC848B/BC847B			
CT 61053	830100484800	SMD TRANS BC848B/BC847B			
CT 81220	830100484800	SMD TRANS BC848B/BC847B			
CT 81225	830100484800	SMD TRANS BC848B/BC847B			
CT 85502	830100385800	SMD TRANS BC858B/BC857B			
D 40584	830921504500	DIODE 1N4148	Q 34043	838212104400	QUARZ 4,433619MHZ
D 40586	830921504500	DIODE 1N4148	Q 34044	838204900300	QUARZ 3,579545MHZ
D 43055	830921504500	DIODE 1N4148	Q 80001	838208004000	QUARZ 4MHZ
D 43056	830921504500	DIODE 1N4148	Q 80951	838216204100	QUARZ 4MHZ
D 50023	830921502000	DIODE 1N4004	R 40551	873229240700	DRW 4 1,8 OHM 10%
D 50048	830970301400	Z-DIODE ZPY5,6 2%	R 43006	870001124600	KSW 0204 7,5 OHM 5%
D 52001	830921504500	DIODE 1N4148	R 50047	876642460200	KSW 0207 1,1 OHM 1%
D 53003	830920100500	DIODE BA157	R 50048	870552103300	MOW 0411 22 OHM 5%
D 54001	830920426800	DIODE BYV16	R 50050	870522705300	MOW 0411 150 OHM 5%
D 54011	830920100500	DIODE BA157	R 52004	870552105300	MOW 0411 150 OHM 5%
D 54022	830972033000	Z-DIODE 30B 0,5W	R 53002	870042909700	KSW NB 0207 10 KOHM 5%
D 57013	830921504500	DIODE 1N4148	R 53009	871033814500	MGW AX 1 MOHM 5%
D 57023	830921504500	DIODE 1N4148	R 53011	870552102100	MOW 0411 6,8 OHM 5%
D 60506	830951685400	DIODE BYT54M	R 53016	873018942500	DRW 9 10 OHM 10%
D 60509	830966318000	Z-DIODE BZT03D180	R 53021	870522707100	MOW 0411 820 OHM 5%
D 60512	830951675400	DIODE BYT53B	R 53033	870552100500	MOW 0411 1,5 OHM 5%
D 60523	830856038400	GLR.SKB380C1500	R 53074	870556107100	MOW 0617 820 OHM 5%
D 61016	830951717800	DIODE BYW178	R 54001	870552102500	MOW 0411 10 OHM 5%
D 61036	830951710800	DIODE BYT108-400	R 54006	870552100900	MOW 0411 2,2 OHM 5%
D 61056	830951717200	DIODE BYW172D	R 54022	870556111100	MOW 0617 39 KOHM 5%
D 85001	830994460100	LE DIODE TLH4601	R 60502	870006935600	KSW 0617 3 MOHM 2%
F 32109	860275506600	KERTRAP #66 5,5/6,6,5MHZ	R 60504	870006934700	KSW 0617 1,2 MOHM 2%
F 32121	814111136000	FILTER 7X7 360 SIGN 11136	R 60508	870556110500	MOW 0617 22 KOHM 5%
F 32410	814053445100	SPULE 7X7 #451 SIGN534451	R 60509	870556110500	MOW 0617 22 KOHM 5%
F 32412	831900395300	OFWFL K3953M	R 60516	879005004600	ESTR.SK10-A 4,7 KOHM LIN
F 32430	831900465400	OFWFL K4654K	R 61018	870552111900	MOW 0411 82 KOHM 5%
F 34052	814111675000	FILTER 7X7 #750 SIGN11675	R 62501	831120001600	PTC DUO T251-A80-A10
IC 34015	830512524800	IC STV2248	R 62502	831100501700	NTC 4,7 OHM 30%
IC 40550	830534726600	IC TDA7266B	R 62549	8765049196100	MSW SI 0414 4,7 MOHM
IC 50010	830533817500	IC TDA8174AW	SI 40551	831561902800	SI LOET T1,6A 250V
IC 60510	830533464600	IC TDA16846	SI 62501	831561700600	SI SX20 T2,5A L 250V
IC 61040	830520431700	IC LM317T	T 52001	830328563700	TRANS BC637
IC 61050	830520431700	IC LM317T	T 53001	830290002000	TRANS S2055N
IC 61060	830520570300	IC MC7805CT	T 60506	830280504000	TRANS IRFBC40
IC 80500	830521006500	IC MC33164P-5RP	TR 52001	092468680400	TRAF0 TREIBER TRANSFORMER DRIVER
IC 80920	297980320100	IC 27C020 PROG.KPL	TR 53010	△ 292210315700	TRAF0 DIODEN-SPLIT
IC 81500	293052194200	PROZESSORPLATTE	WW. △	292016651101	TRAF0 DIODEN-SPLIT
WW.	830415513200	IC ST92195C9B1-S252	TR 61000	△ 292015219703	TRANSFORMER DIODE SPLIT SPERRWANDLERTRAF0 B.O.TYPE CONVERTER TRANSFORMER
IC 84501	830546133000	IC TSOP1330			
L 31043	814052644000	DR ST 0411-GRP 8,2UH 10%			
L 32109	814052696000	DR 0309 4,7UH 10%			
L 40512	814050525900	DR A AX-GA 27UH 10%			
L 52251	814051174900	DR AX 0411-GA 10UH 10%			
L 52256	814052632000	DR AX 0411-GA 3,3UH 10% CHOKE			

Es gelten die Vorschriften und Sicherheitshinweise gemäß dem Service Manual "Sicherheit", Mat.-Nummer 720108000000, sowie zusätzlich die eventuell abweichenden, landesspezifischen Vorschriften!



The regulations and safety instructions shall be valid as provided by the "Safety" Service Manual, part number 720108000000, as well as the respective national deviations.

ÄNDERUNGEN VORBEHALTEN / SUBJECT TO ALTERATION

ÄNDERUNGEN VORBEHALTEN / SUBJECT TO ALTERATION

Ersatzteilliste
Spare Parts List

3 / 2002

CHASSIS-FS-STEREO CUC 2121 MULTI DOLBY
CHASSIS TV STEREO CUC 2121 MULTI DOLBY

MATERIAL-NR. / PART NO.: 297040138000

POS. NR. POS. NO.	ABB. FIG.	MATERIAL-NR. PART NUMBER	ANZ. QTY.	BEZEICHNUNG (D)	DESCRIPTION (GB)
		297040138000		CHASSIS-FS-STEREO CUC 2121 MULTI DOLBY KEIN E-TEIL	CHASSIS TV STEREO CUC 2121 MULTI DOLBY NO SPARE PART
0100.000		295045010100		TUNER-PLL STEHEND	TUNER-PLL TOP ENTRY
0215.000		297033571100		TASTSCHALTER PROGRAMM +	KEY SWITCH PROGRAMME +
0215.000		297033571100		TASTSCHALTER PROGRAMM -	KEY SWITCH PROGRAMME -
0215.000		297033571100		TASTSCHALTER LAUTSTAERKE +	KEY SWITCH VOLUME +
0215.000		297033571100		TASTSCHALTER LAUTSTAERKE -	KEY SWITCH VOLUME -
0240.000		293033904200		KOPFHOERERBUCHSE 3,5mm O.SCHALTER	HEADPHONE SOCKET 3,5mm W/O SWITCH
0241.000		293031680503		CINCH-BUCHSE 3-FACH FBAS/NF L,R	CINCH SOCKET 3 FOLD FBAS/AF L,R
0247.000		293031190603		EURO-AV BUCHSENLEISTE 21-POL SW	EURO-AV SOCKET STRIP 21 PIN BLACK
0312.000		297006430104		ABDECKUNG EURO-AV	COVER EURO-AV
0500.000		295041028400		BAUSTEIN STEREO	STEREO MODULE
0910.000	△	292107030100	X	FOKUSLEITUNG	FOCUSING CABLE
1000.000	△	096211130206	2	SICHERUNGSHALTER Si62501	FUSE HOLDER Si62501
2000.000	△	297033910600		NETZSCHALTER O.WISCHER	POWER SWITCH W/O WIPER
2200.000	△	293033995100		NETZ EINBAUGERAETESTECKER	APPLIANCE COUPLER
2400.000		293031530107		MONTAGECLIP IC40550	MOUNTING CLIP IC40550
2410.000		293031530208	2	MONTAGECLIP T53001/IC50010	MOUNTING CLIP T53001/IC50010
2440.000		293031531600		MONTAGECLIP T60506	MOUNTING CLIP T60506
2445.000		293031531605	3	MONTAGECLIP IC61040/61050/61060	MOUNTING CLIP IC61040/61050/61060
2470.000		293031562000	4	FOLIE WAERMELEITEND T60506/ IC61040/61050/61060	FOIL HEAT CONDUCTING T60506/ IC61040/61050/61060
				X = SIEHE GESONDERTE E-LISTE WW. = WAHLWEISE	X = SEE SEPARATE PARTS LIST WW. = OPTIONAL

POS. NR. POS. NO.	MATERIAL-NR. PART NUMBER	BEZEICHNUNG DESCRIPTION	POS. NR. POS. NO.	MATERIAL-NR. PART NUMBER	BEZEICHNUNG DESCRIPTION
C 34026	845296706400	ELKO 1000UF +50-20% 10V	CD 32460	830940159200	SMD DIODE BA591
C 40557	845299610700	ELKO 2200UF 20% 16V	CD 32470	830940159200	SMD DIODE BA591
C 50047	845299618700	ELKO 1000UF 20% 35V	CD 34041	830940159200	SMD DIODE BA591
C 50048	845299864700	ELKO 1000UF 20% 25V	CD 80501	830940159200	SMD DIODE BA591
C 53002	851591111400	FOKO KF #35 9000PF 3,5% 1500V			
C 54011	865006704600	KERKO HV C 100PF 20% 1KV	CIC 80910	830581409400	SMD IC MC14094BD
C 54012	845299618700	ELKO 1000UF 20% 35V	CIC 80930	830595012900	SMD IC ST92R195C9M1
C 60501	865008112500	KERKO HV C 1000PF 20% 1K	CIC 82501	830596000800	SMD IC M24C08CM1TR
C 60509	851591104500	FOKO FKP1 680PF 10% 1600V			
C 60512	865008111100	KERKO HV C 270PF 20% 2KV	CL 40511	810498233100	SMD DAEMP-FERLE 0805 BLM SMD DAMPING BEAD
C 60523	865008112500	KERKO HV C 1000PF 20% 1KV			
C 60524	865008112500	KERKO HV C 1000PF 20% 1KV			
C 60526	865008112500	KERKO HV C 1000PF 20% 1KV	CT 32111	830100484800	SMD TRANS BC848B/BC847B
C 60527	865008112500	KERKO HV C 1000PF 20% 1KV	CT 32122	830100385800	SMD TRANS BC858B/BC857B
C 61016	851591104000	FOKO FKP1 220PF 10% 1600V	CT 32123	830100484800	SMD TRANS BC848B/BC847B
C 61036	865006704600	KERKO HV C 100PF 20% 1KV	CT 32124	830100385800	SMD TRANS BC858B/BC857B
C 61056	865006704600	KERKO HV C 100PF 20% 1KV	CT 32132	830100484800	SMD TRANS BC848B/BC847B
C 62501 △	851179301800	FOKO MP3 0,1UF 20% 275V	CT 32460	830100484800	SMD TRANS BC848B/BC847B
C 62521 △	866009623800	KERKO SI 2200PF 20% 400V	CT 32470	830100484800	SMD TRANS BC848B/BC847B
C 62522 △	866009623800	KERKO SI 2200PF 20% 400V	CT 32480	830100484800	SMD TRANS BC848B/BC847B
C 62549 △	866009623400	KERKO SI 1000PF 20% 400V	CT 34031	830100385800	SMD TRANS BC858B/BC857B
C 81063	814054010400	EMIFIL 0,1 UF -GR	CT 40581	830100385800	SMD TRANS BC858B/BC857B
CD 32411	830940159200	SMD DIODE BA591	CT 43010	830100385800	SMD TRANS BC858B/BC857B
			CT 43015	830100484800	SMD TRANS BC848B/BC847B

ÄNDERUNGEN VORBEHALTEN / SUBJECT TO ALTERATION

GRUNDIG

TV

POS. NR. POS. NO.	MATERIAL-NR. PART NUMBER	BEZEICHNUNG DESCRIPTION	POS. NR. POS. NO.	MATERIAL-NR. PART NUMBER	BEZEICHNUNG DESCRIPTION
CT 50005	830100484800	SMD TRANS BC848B/BC847B	L 53003	810498205600	FERRITPERLE HF70 BTL 3,5X FERRITE BEAD
CT 50015	830100484800	SMD TRANS BC848B/BC847B	L 53011	814050524900	DR A AX-GA 10UH 10% CHOKE
CT 50040	830100484800	SMD TRANS BC848B/BC847B	L 53021	292031149500	LINEARITAETSREGLER LINEARITY CONTROL
CT 50050	830100484800	SMD TRANS BC848B/BC847B	L 53074	092468700101	ZB-SPULLE ZB COIL
CT 50055	830100484800	SMD TRANS BC848B/BC847B	L 60506	810498205700	FERRITPERLE 3,6UH 5720500
CT 52260	830100385800	SMD TRANS BC858B/BC857B	L 61038	810498200300	FERRITPERLE BL02RN2-R62
CT 57020	830100385800	SMD TRANS BC858B/BC857B	L 62501 △	295008269700	FERRITE BEAD FUNKENTSTOERDROSSEL
CT 57021	830100385800	SMD TRANS BC858B/BC857B	L 81061	810498205100	INTERFERENCE CHOKE FERRITPERLE HF55 BTL 3,5X
CT 57112	830100385800	SMD TRANS BC858B/BC857B	L 81062	814052636100	FERRITE BEAD DR 0411 10UH 5%
CT 57113	830100385800	SMD TRANS BC858B/BC857B	L 81064	814052636100	FERRITE BEAD DR 0411 10UH 5% CHOKE
CT 57124	830100484800	SMD TRANS BC848B/BC847B	Q 34043	838212104400	QUARZ 4,433619MHZ
CT 61043	830100484800	SMD TRANS BC848B/BC847B	Q 34044	838204900300	QUARZ 3,579545MHZ
CT 61053	830100484800	SMD TRANS BC848B/BC847B	Q 80001	838208004000	QUARZ 4MHZ
CT 81220	830100484800	SMD TRANS BC848B/BC847B	Q 80951	838216204100	QUARZ 4MHZ
CT 81225	830100484800	SMD TRANS BC848B/BC847B	R 40551	873229240700	DRW 4 1,8 OHM 10%
CT 85502	830100385800	SMD TRANS BC858B/BC857B	R 43006	870001124600	KSW 0204 75 OHM 5%
D 40584	830921504500	DIODE 1N4148	R 50047	876642460200	MSW 0207 1,1 OHM 1%
D 40586	830921504500	DIODE 1N4148	R 50048 △	870552103300	MOW 0411 22 OHM 5%
D 43055	830921504500	DIODE 1N4148	R 50050 △	870522705300	MOW 0411 150 OHM 5%
D 43056	830921504500	DIODE 1N4148	R 52004 △	870552105300	MOW 0411 150 OHM 5%
D 50023	830921502000	DIODE 1N4004	R 53002 △	870042909700	KSW NB 0207 10 KOHM 5%
D 50048	830970301400	Z-DIODE ZPY5,6 2%	R 53009	871033814500	MGW AX 1 MOHM 5%
D 52001	830921504500	DIODE 1N4148	R 53011 △	870552102100	MOW 0411 6,8 OHM 5%
D 53003	830920100500	DIODE BA157	R 53016	873018942500	DRW 9 10 OHM 10%
D 54001	830920426800	DIODE BYV16	R 53021 △	870522707100	MOW 0411 0,22 OHM 5%
D 54011	830920100500	DIODE BA157	R 53033	870552098500	MOW 0411 0,22 OHM 5%
D 54022	830972033000	Z-DIODE 30 B 0,5W	R 53074 △	870556107100	MOW 0617 820 OHM 5%
D 57013	830921504500	DIODE 1N4148	R 54001 △	870552102500	MOW 0411 10 OHM 5%
D 57023	830921504500	DIODE 1N4148	R 54006 △	870552100900	MOW 0411 2,2 OHM 5%
D 60506 △	830951685400	DIODE BYT54M	R 54022 △	870556111100	MOW 0617 39 KOHM 5%
D 60509 △	830966318000	Z-DIODE BZT03D180	R 60502	870006935600	KSW 0617 3 MOHM 2%
D 60512	830951675400	DIODE BYT53B	R 60504	870006934700	KSW 0617 1,2 MOHM 2%
D 60523	830850638400	GLR.SKB380C1500	R 60508 △	870556110500	MOW 0617 22 KOHM 5%
D 61016 △	830951717800	DIODE BYW178	R 60509 △	870556110500	MOW 0617 22 KOHM 5%
D 61036 △	830951710800	DIODE BYW108-400	R 60516	879005004600	ESTR.SK10-A 0,7 KOHM LIN
D 61056 △	830951717200	DIODE BYW172D	R 61018 △	870552111900	MOW 0411 82 KOHM 5%
D 85001	830994460100	LE DIODE TLHR4601	R 62501 △	831120001700	PTC DUO B59709-T60-A110
F 32109	860275506600	FILTER #66 5,5/6/6,5MHZ	R 62502	831100501800	NTC 4,7 OHM 30%
F 32121	814111136000	KERTRAP 7X7 360 SIGN 11136	R 62549 △	876504916100	MSW SI 0414 4,7 MOHM
F 32410	814053445100	SPULE 7X7 #451 SIGN534451	SI 40551 △	831561902800	SI LOET T1,6A 250V
F 32412	831900395300	OFWFIL K3953M	SI 62501 △	831561700600	SI 5X20 T2,5A L 250V
F 32430	831900465400	OFWFIL K4654M	T 52001	830328563700	TRANS BC637
F 34052	814111675000	FILTER 7X7 #750 SIGN11675	T 53001	830290002000	TRANS S2055N
IC 34015	830512524800	IC STV2248	T 60506	830280504000	TRANS IRFBC40
IC 40550	830534726600	IC TDA7266B	TR 52001	092468680400	TRAFO TREIBER TRANSFORMER DRIVER
IC 50010	830533817500	IC TDA8174AW	TR53010 △	292210315700	TRAFO DIDEN-SPLIT
IC 60510	830533464600	IC TDA16846	WW △	292016651101	TRAFO DIDEN-SPLIT TRANSFORMER DIODE SPLIT
IC 61040	830520431700	IC LM317T	TR 61000 △	292015219703	SPERRWANDLERTRAFO B.O.TYPE CONVERTER TRANSFORMER
IC 61050	830520431700	IC LM317T			
IC 61060	830520570300	IC MC7805CT			
IC 80500	830521006500	IC MC33164P-5RP			
IC 80920	297980320100	IC 27C020 PROG.KPL			
IC 81500	293052194200	PROZESSORPLATTE			
WW.	830415513200	IC ST92195C9B1-S252			
IC 84501	830546133000	IC TSOP1330			
L 31043	814052644000	DR ST 0411-GRP 8,2UH 10%			
L 32109	814052690600	DR 0309 4,7UH 10%			
L 40512	814050525900	DR A AX-GA 27UH 10%			
L 52251	814051174900	DR AX 0411-GA 10UH 10%			
L 52256	814052632000	DR AX 0411-GA 3,3UH 10% CHOKE			

Es gelten die Vorschriften und Sicherheitshinweise gemäß dem Service Manual "Sicherheit", Mat.-Nummer 720108000000, sowie zusätzlich die eventuell abweichenden, landesspezifischen Vorschriften!



The regulations and safety instructions shall be valid as provided by the "Safety" Service Manual, part number 720108000000, as well as the respective national deviations.

ÄNDERUNGEN VORBEHALTEN / SUBJECT TO ALTERATION

Ersatzteilliste Spare Parts List

3 / 2002

CHASSIS-FS-STEREO CUC 2121 MULTI DOLBY CHASSIS TV STEREO CUC 2121 MULTI DOLBY

MATERIAL-NR. / PART NO.: 297040138100

POS. NR. POS. NO.	ABB. FIG.	MATERIAL-NR. PART NUMBER	ANZ. QTY.	BEZEICHNUNG (D)	DESCRIPTION (GB)
		297040138100		CHASSIS-FS-STEREO CUC 2121 MULTI DOLBY KEIN E-TEIL	CHASSIS TV STEREO CUC 2121 MULTI DOLBY NO SPARE PART
0100.000		295045010100		TUNER-PLL STEHEND	TUNER-PLL TOP ENTRY
0215.000		297033571100		TASTSCHALTER PROGRAMM +	KEY SWITCH PROGRAMME +
0215.000		297033571100		TASTSCHALTER PROGRAMM -	KEY SWITCH PROGRAMME -
0215.000		297033571100		TASTSCHALTER LAUTSTÄRKE +	KEY SWITCH VOLUME +
0215.000		297033571100		TASTSCHALTER LAUTSTÄRKE -	KEY SWITCH VOLUME -
0240.000		293033904200		KOPFHOERERBUCHSE 3,5mm O.SCHALTER	HEADPHONE SOCKET 3,5mm W/O SWITCH
0241.000		293031180503		CINCH-BUCHSE 3-FACH FBAS/NF L,R	CINCH SOCKET 3 FOLD FBAS/AF L,R
0247.000		293031190603		EURO-AV BUCHSENLEISTE 21-POL SW	EURO-AV SOCKET STRIP 21 PIN BLACK
0312.000		297006430104		ABDECKUNG EURO AV	COVER EURO AV
0500.000		295041028400	X	FAUSTEIN STEREO	STEREO MODULE
0910.000	△	292107030100		FOKUSLEITUNG	FOCUSING CABLE
1000.000	△	096211130206	2	SICHERUNGSHALTER SI62501	FUSE HOLDER SI62501
2000.000	△	297033910600		NETZSCHALTER O.WISCHER	POWER SWITCH W/O WIPER
2200.000	△	293033995100		NETZ EINBAUGERAETESTECKER	APPLIANCE COUPLER
2400.000		293031530107		MONTAGECLIP IC40550	MOUNTING CLIP IC40550
2410.000		293031530208	2	MONTAGECLIP T53001/IC50010	MOUNTING CLIP T53001/IC50010
2440.000		293031531600		MONTAGECLIP T60506	MOUNTING CLIP T60506
2445.000		293031531605	3	MONTAGECLIP IC61040/61050/61060	MOUNTING CLIP IC61040/61050/61060
2470.000		293031562000	4	FOILIE WAERMELEITEND T60506/ IC61040/61050/61060	FOIL HEAT CONDUCTING T60506/ IC61040/61050/61060
				X = SIEHE GESONDERTE E-LISTE	X = SEE SEPARATE PARTS LIST
				WW. = WAHLWEISE	WW. = OPTIONAL

POS. NR. POS. NO.	MATERIAL-NR. PART NUMBER	BEZEICHNUNG DESCRIPTION	POS. NR. POS. NO.	MATERIAL-NR. PART NUMBER	BEZEICHNUNG DESCRIPTION
C 34026	845296706400	ELKO 1000UF +50-20% 10V	CD 32460	830940159200	SMD DIODE BA591
C 40557	845299610700	ELKO 2200UF 20% 16V	CD 32470	830940159200	SMD DIODE BA591
C 50047	845299618700	ELKO 1000UF 20% 35V	CD 34041	830940159200	SMD DIODE BA591
C 50048	845299864700	ELKO 1000UF 20% 25V	CD 80501	830940159200	SMD DIODE BA591
C 53002	851591110200	FOKO FKP1/4 8500PF 3.5% 1500V			
C 54011	865006704600	KERKO HV C 1000PF 20% 1KV	CIC 80910	830581409400	SMD IC MC14094BD
C 54012	845299618700	ELKO 1000UF 20% 35V	CIC 80930	830595012900	SMD IC ST92R195C9Q1
C 60501	865008112500	KERKO HV C 1000PF 20% 1KV	CIC 82501	830596008000	SMD IC M24C08CM1TR
C 60509	851591104500	FOKO FKP1 680PF 10% 1600V			
C 60512	865008111100	KERKO HV C 270PF 20% 2KV	CL 40511	810498233100	SMD DAEMPF-PERLE 0805 BLM SMD DAMPING BEAD
C 60523	865008112500	KERKO HV C 1000PF 20% 1KV			
C 60524	865008112500	KERKO HV C 1000PF 20% 1KV			
C 60526	865008112500	KERKO HV C 1000PF 20% 1KV	CT 32111	830100484800	SMD TRANS BC848B/BC847B
C 60527	865008112500	KERKO HV C 1000PF 20% 1KV	CT 32122	830100385800	SMD TRANS BC858B/BC857B
C 61016	851591104000	FOKO FKP1 200PF 10% 1600V	CT 32123	830100484800	SMD TRANS BC848B/BC847B
C 61036	865006704600	KERKO HV C 100PF 20% 1KV	CT 32124	830100385800	SMD TRANS BC858B/BC857B
C 61056	865006704600	KERKO HV C 100PF 20% 1KV	CT 32132	830100484800	SMD TRANS BC848B/BC847B
C 62501	851179301800	FOKO MP3 0,1UF 20% 275V	CT 32460	830100484800	SMD TRANS BC848B/BC847B
C 62521	866009623800	KERKO SI 2200PF 20% 400V	CT 32470	830100484800	SMD TRANS BC848B/BC847B
C 62522	866009623800	KERKO SI 2200PF 20% 400V	CT 32480	830100484800	SMD TRANS BC848B/BC847B
C 62549	866009623400	KERKO SI 1000PF 20% 400V	CT 34031	830100385800	SMD TRANS BC858B/BC857B
C 81063	814054010400	EMIFIL 0,1 UF -GR	CT 40581	830100385800	SMD TRANS BC858B/BC857B
			CT 43010	830100385800	SMD TRANS BC858B/BC857B
CD 32411	830940159200	SMD DIODE BA591	CT 43015	830100484800	SMD TRANS BC848B/BC847B

ÄNDERUNGEN VORBEHALTEN / SUBJECT TO ALTERATION

GRUNDIG

TV

POS. NR. POS. NO.	MATERIAL-NR. PART NUMBER	BEZEICHNUNG DESCRIPTION	POS. NR. POS. NO.	MATERIAL-NR. PART NUMBER	BEZEICHNUNG DESCRIPTION
CT 50005	830100484800	SMD TRANS BC848B/BC847B	L 53003	810498205600	FERRITPERLE HF70 BTL 3,5X
CT 50015	830100484800	SMD TRANS BC848B/BC847B			FERRITE BEAD
CT 50040	830100484800	SMD TRANS BC848B/BC847B	L 53011	814050524900	DR A AX-GA 10UH 10% CHOKE
CT 50050	830100484800	SMD TRANS BC848B/BC847B	L 53021	292031149500	LINEARITAETSREGLER
CT 50055	830100484800	SMD TRANS BC848B/BC847B			LINEARITY CONTROL
CT 52260	830100385800	SMD TRANS BC858B/BC857B	L 53074	092468700101	ZB-SPULE
CT 57020	830100385800	SMD TRANS BC858B/BC857B			ZB COIL
CT 57021	830100385800	SMD TRANS BC858B/BC857B	L 60506	810498205700	FERRITPERLE 3,6UH 5720500
CT 57112	830100385800	SMD TRANS BC858B/BC857B	L 61038	810498200300	FERRITPERLE BL02RN2-R62
CT 57113	830100385800	SMD TRANS BC858B/BC857B			FERRITE BEAD
CT 57124	830100484800	SMD TRANS BC848B/BC847B	L 62501	△ 295008269700	FUNKENTSTOERDROSSEL INTERFERENCE CHOKE
CT 61043	830100484800	SMD TRANS BC848B/BC847B	L 81061	810498205100	FERRITPERLE HF55 BTL 3,5X
CT 61053	830100484800	SMD TRANS BC848B/BC847B			FERRITE BEAD
CT 81220	830100484800	SMD TRANS BC848B/BC847B	L 81062	814052636100	DR 0411 10UH 5%
CT 81225	830100484800	SMD TRANS BC848B/BC847B	L 81064	814052636100	DR 0411 10UH 5% CHOKE
CT 85502	830100385800	SMD TRANS BC858B/BC857B			
D 40584	830921504500	DIODE 1N4148	Q 34043	838212104400	QUARZ 4,433619MHZ
D 40586	830921504500	DIODE 1N4148	Q 34044	838204900300	QUARZ 3,579545MHZ
D 43055	830921504500	DIODE 1N4148	Q 80001	838208004000	QUARZ 4MHZ
D 43056	830921504500	DIODE 1N4148	Q 80951	838216204100	QUARZ 4MHZ
D 50023	830921502000	DIODE 1N4004			
D 50048	830970301400	Z-DIODE ZPY5,6 2%	R 40551	873229240700	DRW 4 1,8 OHM 10%
D 52001	830921504500	DIODE 1N4148	R 43006	870001124600	KSW 0204 7,5 OHM 5%
D 53003	830920100500	DIODE BA157	R 50047	876642460200	MSW 0207 1,1 OHM 1%
D 54001	830920426800	DIODE BYV16	R 50048	870552103300	MOW 0411 22 OHM 5%
D 54011	830920100500	DIODE BA157	R 50050	870522705300	MOW 0411 150 OHM 5%
D 54022	830972033000	Z-DIODE 30B 0,5W	R 52004	870552105300	MOW 0411 150 OHM 5%
D 57013	830921504500	DIODE 1N4148	R 53002	870042909700	KSW NB 0207 10 KOHM 5%
D 57023	830921504500	DIODE 1N4148	R 53009	871033814500	MSW AX 1 MOHM 5%
D 60506	830951685400	DIODE BYT54M	R 53011	870552102100	MOW 0411 6,8 OHM 5%
D 60509	830966318000	Z-DIODE BZT03D180	R 53016	873018942500	DRW 9 10 OHM 10%
D 60512	830951675400	DIODE BYT53B	R 53021	870522707100	MOW 0411 820 OHM 5%
D 60523	830856038400	GLR.SKB380C1500	R 53033	870552098500	MOW 0411 0,22 OHM 5%
D 61016	830951717800	DIODE BYW178	R 53074	870556107100	MOW 0617 820 OHM 5%
D 61036	830951710800	DIODE BYT108-400	R 54001	870552102500	MOW 0411 10 OHM 5%
D 61056	830951717200	DIODE BYW172D	R 54006	870552100900	MOW 0411 2,2 OHM 5%
D 85001	830994460100	LE DIODE TLH4601	R 54022	870556111100	MOW 0617 39 KOHM 5%
F 32109	860275506600	KERTRAP #66 5,5/6,6,5MHZ	R 60502	870006935600	KSW 0617 3 MOHM 2%
F 32121	814111136000	FILTER 7X7 360 SIGN 11136	R 60504	870006934700	KSW 0617 1,2 MOHM 2%
F 32410	814053445100	SPULE 7X7 #451 SIGN534451	R 60508	870556110500	MOW 0617 22 KOHM 5%
F 32412	831900395300	OFWFL K3953M	R 60509	870556110500	MOW 0617 22 KOHM 5%
F 32430	831900465400	OFWFL K4654K	R 60516	879005004600	ESTR.SK10-A 4,7 KOHM LIN
F 34052	814111675000	FILTER 7X7 #750 SIGN11675	R 61018	870552111900	MOW 0411 82 KOHM 5%
IC 34015	830512524800	IC STV2248	R 62501	831120001800	PTC DUO B59709-T60-A110
IC 40550	830534726600	IC TDA7266B	R 62502	831100501700	NTC 4,7 OHM 30%
IC 50010	830533817500	IC TDA8174AW	R 62549	876504916100	MSW SI 0414 4,7 MOHM
IC 60510	830533464600	IC TDA16846	SI 40551	831561902800	SI LOET T1,6A 250V
IC 61040	830520431700	IC LM317T	SI 62501	831561700600	SI SX20 T2,5A L 250V
IC 61050	830520431700	IC LM317T	T 52001	830328563700	TRANS BC637
IC 61060	830520570300	IC MC7805CT	T 53001	830290002000	TRANS S2055N
IC 80500	830521006500	IC MC33164P-5RP	T 60506	830280504000	TRANS IRFBC40
IC 80920	297980320100	IC 27C020 PROG.KPL			
IC 81500	293052194200	PROZESSORPLATTE			
WW.	830415513200	IC ST92195C9B1-S252			
IC 84501	830546133000	IC TSOP1330	TR 52001	092468680400	TRAFO TREIBER TRANSFORMER DRIVER
L 31043	814052644000	DR ST 0411-GRP 8,2UH 10%	TR 53010	△ 292210315700	TRAFO DIODEN-SPLIT
L 32109	814052696000	DR 0309 4,7UH 10%	TR 53020	△ 292016651101	TRAFO DIODEN-SPLIT
L 40512	814050525900	DR A AX-GA 27UH 10%			TRANSFORMER DIODE SPLIT
L 52251	814051174900	DR AX 0411-GA 10UH 10%	TR 61000	△ 292015219703	SPERRWANDLERTRAFO B.O.TYPE CONVERTER TRANSFORMER
L 52256	814052632000	DR AX 0411-GA 3,3UH 10% CHOKE			

Es gelten die Vorschriften und Sicherheitshinweise gemäß dem Service Manual "Sicherheit", Mat.-Nummer 720108000000, sowie zusätzlich die eventuell abweichenden, landesspezifischen Vorschriften!



The regulations and safety instructions shall be valid as provided by the "Safety" Service Manual, part number 720108000000, as well as the respective national deviations.

ÄNDERUNGEN VORBEHALTEN / SUBJECT TO ALTERATION

Ersatzteilliste
Spare Parts List

TV

5 / 2001

BAUSTEIN NETZTEIL 12V
MODULE POWER SUPPLY 12V

MATERIAL-NR. / PART NO.: 293050073400

POS. NR. POS. NO.	ABB. FIG.	MATERIAL-NR. PART NUMBER	ANZ. QTY.	BEZEICHNUNG (D)	DESCRIPTION (GB)
		293050073400		BAUSTEIN NETZTEIL 12V	MODULE POWER SUPPLY 12V
0243.000	△	293033960104		NETZ BATTERIE STECKERGEH.	MAINS BATTERY CONNECTOR
1000.000	△	096211130206	2	SICHERUNGSHALTER SI60401	FUSE HOLDER SI60401
2400.000		293031530107	2	MONTAGECLIP T60447/60448	MOUNTING CLIP T60447/60448
2410.000		293031531208		MONTAGECLIP D60463	MOUNTING CLIP D60463
2450.000		293031561800	2	FOLIE WAERMELEITEND T60447/60448	FOIL HEAT CONDUCTING T60447/60448
2460.000		293031562000		FOLIE WAERMELEITEND D60463	FOIL HEAT CONDUCTING D60463

WW.=WAHLWEISE

WW.=OPTIONAL

POS. NR. POS. NO.	MATERIAL-NR. PART NUMBER	BEZEICHNUNG DESCRIPTION	POS. NR. POS. NO.	MATERIAL-NR. PART NUMBER	BEZEICHNUNG DESCRIPTION
C 60401	845201622800	ELKO SNT #3 1000UF 20% 40V	D 60477	830951709700	DIODE BYT 56 M
C 60402	845201622800	ELKO SNT #3 1000UF 20% 40V	IC 60420	830521006000	IC MC34060AP
C 60403	845201622800	ELKO SNT #3 1000UF 20% 40V	L 60441	810498205700	FERRITPERLE 3,6UH 5720500
C 60460	865008111100	KERKO HV C 270PF 20% 2KV	L 60442	810498205700	FERRITPERLE 3,6UH 5720500
C 60463	845201622800	ELKO SNT #3 1000UF 20% 40V	L 60460	810498200300	FERRITPERLE BL02RN2-R62
C 60465	851591104300	FOKO KF #29 470PF 10% 1600V	L 60462	810498200300	FERRITPERLE BL02RN2-R62
C 60477	865008111100	KERKO HV C 270PF 20% 2KV	L 60463	092410595100	FERRITE BEAD
C 60478	865008111100	KERKO HV C 270PF 20% 2KV	L 60478	810498200300	STABKERNDROSSEL 10UH BAR CORE CHOKE COIL
C 60481	865008112500	KERKO HV C 1000PF 20% 1KV	L 60478	810498200300	FERRITPERLE BL02RN2-R62
CD 60401	830945506200	MELF-Z DIODE 6,2 C 0,5 W			FERRITE BEAD
CD 60405	830945510100	MELF-Z DIODE 10 B 0,5W	R 60401	△ 870042901700	KSW NB 0207 4,7 OHM 5% ST
CD 60438	830945515000	MELF Z-DIODE 15V B 0,5W	R 60414	879200212500	ESTR.S6 470 OHM LIN
CD 60443	830953414900	MELF-DIODE LL 4148	R 60451	875099702500	DRW-MET.BAND 0,1 OHM 5% 3W
CD 60464	830945504700	MELF-Z DIODE 4,7 C 0,5 W	R 60452	875099702500	DRW-MET.BAND 0,1 OHM 5% 3W
CT 60402	830100484800	SMD TRANS BC848B/ BC847B	R 60453	875099702500	DRW-MET.BAND 0,1 OHM 5% 3W
CT 60403	830100684800	SMD TRANS BC848C/ BC847C	R 60454	875099702500	DRW-MET.BAND 0,1 OHM 5% 3W
CT 60427	830100385800	SMD TRANS BC858B/ BC857B	R 60455	875099702500	DRW-MET.BAND 0,1 OHM 5% 3W
CT 60431	830100385800	SMD TRANS BC858B/ BC857B	R 60476	876504413900	MSW 0414 560 KOHM 5%
CT 60432	830100484800	SMD TRANS BC848B/ BC847B	R 60479	△ 870042904100	KSW NB 0207 47 OHM 5%
CT 60444	830100680800	SMD TRANS BC808-40/ BC807-40	R 60485	△ 870537008400	MOW 0922 3 KOHM 5%
CT 60472	830100581700	SMD-TRANS.BC 817-25	RL 60473	295007170200	RELAIS V23072-C1061-A308
D 60403	830921502000	DIODE 1 N 4004	WW.	295007170100	RELAIS V23072-A1061-A308
D 60404	830971270000	DIODE P600BGI	SI 60401	△ 831598001200	SI 5X20 T12,5A L 250V
D 60405	830921504500	DIODE 1N4148	SI 60402	△ 831562400100	SI LOET T 5A 250V
D 60406	830951802300	DIODE BYV10-40	T 60401	830328963800	TRANS.BC 638-16
D 60431	830972005100	Z DIODE 5,1 B 0,5W	T 60447	830280515000	TRANS.IRFP 150N G2233
D 60432	830972008300	Z DIODE 8,2 B 0,5W	T 60448	830280515000	TRANS.IRFP 150N G2233
D 60436	830919854200	DIODE BAT42/43/BAT85/86	T 60484	830340129900	TRANS.BF299 G/PBF259 RS
D 60441	830951675400	DIODE BYT53B	TR 60460	292016219700	SPERRWANDLERTRAF0 REVERSE CONVERTER TRANSFORMER
D 60461	△ 830982046000	DIODE BYV28-600			
D 60463	△ 830982084000	DIODE MUR 840/BYV 29-400			
D 60473	830920002100	DIODE BAV21			
D 60474	830921512700	DIODE 1 N 4007			
D 60475	830920115900	DIODE BA159			
D 60476	830920115900	DIODE BA159			

Es gelten die Vorschriften und Sicherheitshinweise gemäß dem Service Manual "Sicherheit", Mat.-Nummer 720108000000, sowie zusätzlich die eventuell abweichenden, landesspezifischen Vorschriften!



The regulations and safety instructions shall be valid as provided by the "Safety" Service Manual, part number 720108000000, as well as the respective national deviations.

ÄNDERUNGEN VORBEHALTEN / SUBJECT TO ALTERATION