

# TV

# Service Manual

## DIGI 100

6. Ergänzung / Supplement 6

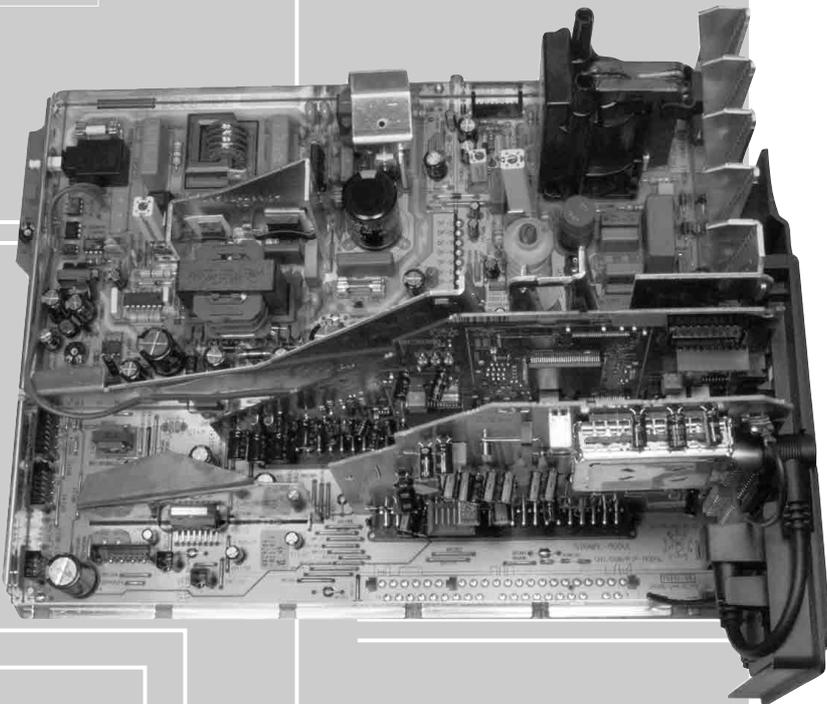

**CUC 1807**

**CUC 1837**

**CUC 1838**

**CUC 1839**

**CUC 1934**

**CUC 1935**

**Geräteliste  
siehe Seite 2, 3  
List of TV Receivers  
see Page 2, 3**

### Grundig Service

Hotline Deutschland...  
...Mo.-Fr. 8.00-18.00 Uhr

Technik:

TV	0180/52318-41
TV	0180/52318-49
SAT	0180/52318-48
VCR/LiveCam	0180/52318-42
HiFi/Audio	0180/52318-43
Car Audio	0180/52318-44
Telekommunikation	0180/52318-45
Fax:	0180/52318-51

Planatron (8.00-22.00 Uhr) 0180/52318-99

Ersatzteil-Verkauf: Mo.-Fr. 8.00-19.00 Uhr

Telefon:	0180/52318-40
Fax:	0180/52318-50

Kundendienst/Werkstätten: Mo.-Fr. 8.00-18.00 Uhr

Telefon:	0180/52318-52
Fax:	0180/52318-46

gebührenpflichtig

Zusätzlich erforderliche Unterlagen für den Komplettservice  
Additionally required Service Documents for the Complete Service

**Service  
Manual**

**DIGI 100**

Materialnr./Part No.  
720100305000

**Ergänzung  
Supplement**

**4 + 5**

Materialnr./Part No.  
720100305400  
720100305500

**Service  
Manual**

**Sicherheit  
Safety**

Materialnr./Part No.  
720108000000

**Service  
Training**

**DIGI 100**

Materialnr./Part No.  
© 720103502100  
© 720103502200

Materialnummer/Part Number 720100305600

Änderungen vorbehalten/Subject to alteration

H-S46 0902

<http://www.grundig.com>

## CUC 1807

### **XENTIA 55 M 55-420/8 DOLBY**

GCL8000 / VNA  
GCL8077 / VNA

## CUC 1837

### **ELEGANCE 63 ST 63-300 DOLBY**

GCL0800 / VNA, VNX  
GCL0820 / VNA, VNX

### **ELEGANCE 63 ST 63-300/8 DOLBY**

GCK9800 / VNA, VNX  
GCK9810 / VNA, VNX

### **XENTIA 63 M 63-420/8 DOLBY**

GCI8300 / VNA, VNX  
GCI8377 / VNA, VNX

### **WIEN SE 6340 DOLBY**

GCM5500 / VNA

### **ST 70-265/8 DOLBY**

GCM5400 / VNA, VNX

### **SEDANCE 70 ST 70-284 DOLBY**

GCK6500 / VNX, VNR, VNU  
GCK6592 / VNA, VNX, VNG, VNR, VNU

### **SEDANCE 70 ST 70-284/8 DOLBY**

GCK6675 / VNA, VNX, VNG, VNR, VNU  
GCK6692 / VNX, VNG, VNR, VNU

### **DAVIO 70 ST 70-292 DOLBY**

GCI8572 / VNA, VNX

### **DAVIO 70 ST 70-292/8 DOLBY**

GCI8452 / VNA, VNX  
GCI8472 / VNA, VNX

### **ELEGANCE 70 ST 70-300 DOLBY**

GCM8300 / VNA, VNX, VNG, VNR, VNU  
GCM8310 / VNA, VNX, VNG, VNR, VNU  
GCM8320 / VNX, VNG, VNR, VNU

### **ELEGANCE 70 ST 70-300/8 DOLBY**

GCL0600 / VNX  
GCL0642 / VNX, VNR  
GCL0692 / VNX, VNR

### **ST 70-398 DOLBY**

GCM3300 / VNA, VNX

### **M 70-879/8 DOLBY**

GCM5100 / VNA

### **ELEGANCE 70 M 70-3110 DOLBY**

GCM6400 / VNA, VNX

### **BOSTON SE 7012 DOLBY**

GCI2324 / VNA  
GCI2375 / VNA

## CUC 1838

### **M 72-109 MV/DOLBY**

GCM5300 / VNA, VNX

### **MF 72-258 DOLBY**

GCM8200 / VNA

### **XENTIA 72 M 72-420 DOLBY**

GCL6900 / VNA  
GCL6977 / VNA

### **XENTIA 72 M 72-420/8 DOLBY**

GCL7000 / VNA  
GCL7077 / VNA

### **XENTIA 72 FLAT MF 72-430 DOLBY**

GCL6777 / VNA, VNX

### **XENTIA 72 FLAT MF 72-430/8 DOLBY**

GCL6877 / VNA, VNX

### **M 72-798 DOLBY**

GCM5200 / VNA, VNX

### **SEDANCE 72 M 72-2110 DOLBY**

GCM2700 / VNA, VNX, VNG

### **SEDANCE 72 M 72-2110 MV/DOLBY**

GCM1900 / VNA, VNX, VNG

### **ELEGANCE 72 FLAT MF 72-3110 DOLBY**

GCM4700 / VNA, VNX

### **ELEGANCE 72 FLAT MF 72-3110/8 DOLBY**

GCL8600 / VNA, VNX

### **LEEMAXX 72 FLAT MF 72-9110/8 DOLBY**

GCM9100 / VNA, VNX

### **TORONTO SE 7216 DOLBY**

GCK6875 / VNA

### **TORONTO SE 7216/8 DOLBY**

GCK6775 / VNA

### **SYDNEY SE 7240 DOLBY**

GCM5700 / VNA  
GCM5710 / VNA

### **ATLANTA FLAT SE 7260 DOLBY**

GCK6475 / VNX, VNG

### **ORLANDO FLAT SE 7270 DOLBY**

GCM6300 / VNX, VNG

## CUC 1839

### M 84-212/8 DOLBY

GCI9090 / VNA

### LENARO 84 MF 84-6110/8 DOLBY

GCM3000 / VNA, VNX

## CUC 1934

### ELEGANCE 70 MW 70-150/8 DOLBY

GCI9142 / VNA

### XENTIA 70 FLAT MFW 70-430/8 DOLBY

GCK9677 / VNA

### ARGANTO 70 MW 70-515 MV/DOLBY

GCM5800 / VNA

## CUC 1935

### ELEGANCE 82 MW 82-150/8 DOLBY

GCI9242 / VNA

GCI9292 / VNA

### XENTIA 82 FLAT MFW 82-430/8 DOLBY

GCK9577 / VNA, VNX, VNG, VNR, VNU, VNN

### ARGANTO 82 MW 82-515 MV/DOLBY

GCM5900 / VNA

### ELEGANCE 82 FLAT MFW 82-3110 MV/DOLBY

GCL8540 / VNA, VNX, VNG

### MW 82-3112 MV/DOLBY

GCM9800 / VNA

GCM9810 / VNA

### HAMBURG SE 8240 DOLBY

GCL7900 / VNA

### DENVER FLAT SE 8260/8 DOLBY

GCM4000 / VNA, VNX, VNG

GCM4010 / VNX, VNG

#### Hinweis

Für diese Geräte sind die Unterschiede zu den im Service Manual 720100305000 und in den Ergänzungen 720100305100...5400 aufgeführten Geräten (VNM) in den Ersatzteillisten dieser Ergänzung dokumentiert.

#### Remark

For these units, the differences with respect to the units (VNM) stated in the Service Manual 720100305000 and in the supplements 720100305100...5400 are documented in the spare parts lists of this supplement.

Es gelten die Vorschriften und Sicherheitshinweise gemäß dem Service Manual "Sicherheit", Materialnummer 720108000000, sowie zusätzlich die eventuell abweichenden, landesspezifischen Vorschriften!



The regulations and safety instructions shall be valid as provided by the "Safety" Service Manual, part number 720108000000, as well as the respective national deviations.

Für die auf den Seiten 2, 3 aufgeführten Geräte gilt das Service Manual DIGI 100.

Diese Ergänzung dokumentiert die Unterschiede bzw. zusätzlichen Bestückungen der Geräte.

Grundlage für den Service sind:

- Service Manual DIGI 100 (Materialnummer 720100305000)
- 4. Ergänzung DIGI 100 (Materialnummer 720100305400)
- 5. Ergänzung DIGI 100 (Materialnummer 720100305500)
- Service Manual "Sicherheit" (Materialnummer 720108000000)

The Service Manual DIGI 100 applies to the sets specified on pages 2, 3.

This supplement describes the differences and the additionally fitted components of the sets.

Basic instructions for servicing are given in the:

- Service Manual DIGI 100 (Part number 720100305000)
- Supplement 4 DIGI 100 (Part number 720100305400)
- Supplement 5 DIGI 100 (Part number 720100305500)
- Service Manual "Safety" (Part number 720108000000)

## Inhaltsverzeichnis

	Seite
Hinweise .....	4
Modulaufistung – Service Manual mit Ergänzungen .....	5
Geräte-Ersatzteillisten .....	6
Chassis-Ersatzteillisten:	
CUC 1807 .....	116
CUC 1837 .....	117
CUC 1838 .....	150
CUC 1839 .....	191
CUC 1934 .....	192
CUC 1935 .....	197

## Table of Contents

	Page
Notes .....	4
List of Modules – Service Manual with Supplements .....	5
Spare Parts Lists for Units .....	6
Spare Parts Lists for Chassis:	
CUC 1807 .....	116
CUC 1837 .....	117
CUC 1838 .....	150
CUC 1839 .....	191
CUC 1934 .....	192
CUC 1935 .....	197

## Hinweise

**Wegen Veränderung des Schwerpunktes beim Abnehmen der Rückwand bzw. Ausbau des Chassis oder Entfernen eines eventuell vorhandenen Standfußes ist das Gerät gegen Kippen zu sichern.**

**Vor dem Öffnen des Gehäuses zuerst den Netzstecker ziehen!**

### Hinweis zu Kabelbindern zum Wiederöffnen

Diese Kabelbinder können durch Drücken der Rastnase in Pfeilrichtung wieder geöffnet werden.

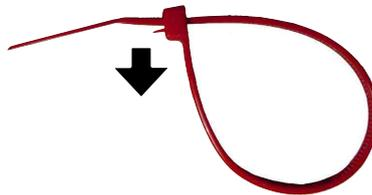

## Signalbaustein

Werden die Signalbausteine 295042022400 / 295042622400 mit Philips-Tuner anstelle der Signalbausteine 295042022100 / 295042622100 mit Grundig-Tuner eingebaut, so müssen im TV-Gerät folgende Einstellungen vorgenommen werden:

- Softwarestand prüfen (durch Betätigen der Taste "i" (EASY DIALOG) und der "grünen" Taste wird die Software-Versionsnummer des TV-Gerätes angezeigt).
- Bei Softwarestand kleiner XXX.31 neuesten Softwarestand laden.
- Tuner "Philips UV 1316S" einstellen (Menü "Terr. Tuner" über "EASY DIALOG" -> "Installation" -> "Servicemenü für Händler" -> Kennzahl "8500" -> "Hardware-Einstellungen").
- Einstellung mit "OK" bestätigen und Menü mit "i" wieder verlassen.

## Notes

**Because of the change of the centre of gravity when removing the rear panel, the chassis or an existing stand, it is necessary to protect the set from tipping.**

**Before opening the cabinet disconnect the mains plug!**

### Note to reopen the cable clamps.

These cable clamps can be reopened by pressing the locking lug in the direction of the arrow.

## Signal Module

If the signal modules 295042022400 / 295042622400 with Philips tuner are fitted in place of the signal modules 295042022100 / 295042622100 with Grundig tuner, the following setting must be carried out on the TV set:

- Check the software version (press the "i" button (EASY DIALOG) and the "green" button to display the software version number of the TV set).
- If the software version is below XXX.31, load the latest version.
- Select the tuner option "Philips UV 1316S", (in the "Terr. Tuner" menu via "EASY DIALOG" -> "Installation" -> "Service menu for the dealer" -> Code "8500" -> "Hardware settings").
- Confirm the setting with "OK" then press "i" to exit the menu.

## Modulauflistung – Service Manual mit Ergänzungen

### List of Modules – Service Manual with Supplements

Modul Module	Materialnummer Part Number	Service Manual DIGI 100	4. Ergänzung Supplement 4 DIGI 100	5. Ergänzung Supplement 5 DIGI 100
		720100305000	720100305400	720100305500
Chassisplatte Chassis Board	29704011 . . . . 29704019 . . . .	Seite / Page 3-1	Seite / Page 9	Seite / Page 27
Signal-Baustein Signal Module	295042022100	Seite / Page 3-33	Seite / Page 39	Seite / Page 45
	295042022400	–	–	Seite / Page 45
	295042622100	Seite / Page 3-33	Seite / Page 39	Seite / Page 45
	295042622400	–	–	Seite / Page 45
Feature-Modul Feature Module	295042032100	Seite / Page 3-19	Seite / Page 25	Seite / Page 53
	295042032200	–	–	Seite / Page 67
	295042033100	–	–	Seite / Page 53
	295042033200	–	–	Seite / Page 67
	295042034200	–	–	Seite / Page 67
Netzteilplatte Mains Section Board	293052022100	–	–	Seite / Page 81
Fokussierungsplatte Focusing Board	293050254400	Seite / Page 3-55	Seite / Page 51	Seite / Page 87
	293050254500	Seite / Page 3-55	Seite / Page 51	Seite / Page 87
	293050255000	–	–	Seite / Page 87
Bildrohrplatte CRT Panel	293051223100	Seite / Page 3-57	Seite / Page 47	–
	293051223300	Seite / Page 3-57	Seite / Page 47	–
	293051223400	Seite / Page 3-57	Seite / Page 47	–
	293051223500	Seite / Page 3-57	Seite / Page 47	–
	293051223600	Seite / Page 3-57	Seite / Page 47	–
	293051224500	–	Seite / Page 47	–
Bedienplatte Control Board	295010851400	–	–	Seite / Page 89
Keyboard	295010840800	–	–	Seite / Page 91
LED-Platte LED Board	293050176400	–	Seite / Page 56	Seite / Page 92
Netzschalterplatte Mains Switch Board	295010870900	–	–	Seite / Page 91
Buchsenplatte Socket Board	293050084500	–	–	Seite / Page 93
	293050085100	–	–	Seite / Page 94
PIP-Signalbaustein PIP Signal Module	295042120400	Seite / Page 3-61	–	–
SAT-Baustein SAT Module	295042220200	Seite / Page 3-65	–	–
PIP/VGA-Baustein PIP/VGA Module	295042062100	Seite / Page 3-70	–	–

MATERIAL-NR. / PART NO.: 921845024000 BESTELL-NR. / ORDER NO.: GCL8000 PROCON SILBER/PROCON SILVER  
VERSION NR./VERSION NO.: VNA

POS. NR. POS. NO.	ABB. FIG.	MATERIAL-NR. PART NUMBER	ANZ. QTY.	BEZEICHNUNG (D)	DESCRIPTION (GB)
		921845024000		XENTIA 55 M 55-420/8 DOLBY PROCON SILBER KEIN E-TEIL	XENTIA 55 M 55-420/8 DOLBY PROCON SILVER NO SPARE PART
0050.000				PROGRAMM FLASH-EPROM DOWNLOAD: WWW.GRUNDIG.DE/ PRODUKTE/KONTAKT/HAENDLERSERVICE	PROGRAM FLASH EPROM DOWNLOAD: WWW.GRUNDIG.DE/ PRODUCTS/CONTACT/RESELLER SUPPORT
0215.000		295017590703		RAHMEN M.TASTENKNOPF NETZ KPL	FRAME W.KEY STRIP POWER CPL
0218.000		296383190101		ZIERLEISTE KPL ALU SILBER	ORNAMENTAL STRIP CPL ALU SILVER
WW.		759550275700		ZIERLEISTE KPL BLAU	ORNAMENTAL STRIP CPL BLUE
WW.		759550275800		ZIERLEISTE KPL HOLZ DUNKEL	ORNAMENTAL STRIP CPL WOOD DARK
WW.		759550275900		ZIERLEISTE KPL HELL GRUEN	ORNAMENTAL STRIP CPL LIGHT GREEN
WW.		759550276000		ZIERLEISTE KPL ORANGE	ORNAMENTAL STRIP CPL ORANGE
0226.000		293033750603		DRAHTFEDER Klappe	WIRE SPRING FLAP
0240.000		293033904200		KOPFHÖRERBUCHSE 3,5 O.SCHALTER	HEADPHONE SOCKET 3,5 W/O SWITCH
0241.000		293031680503		CINCH-BUCHSE 3-FACH FBAS/NF L,R	CINCH SOCKET 3 FOLD FBAS/AF L,R
0320.000		291103016405		TYPENAUFKLEBER VNA	TYPE LABEL VNA
0950.000		292104087100		SHIFTSTECKER KPL 4 W/120 OHM	SHIFT PLUG CPL 4 W/120 OHM
WW.		292104087406		SHIFTSTECKER KPL 4W/220 OHM	SHIFT PLUG CPL 4W/220 OHM
		218459410200		BEDIENUNGSANLEITUNG D	OPERATING INSTRUCTIONS D
		218459410300		BEDIENUNGSANLEITUNG F/I	OPERATING INSTRUCTIONS F/I
		218459410400		BEDIENUNGSANLEITUNG GB/NL	OPERATING INSTRUCTIONS GB/NL
		218459410500		BEDIENUNGSANLEITUNG E/P	OPERATING INSTRUCTIONS E/P
		218459410600		BEDIENUNGSANLEITUNG DK/FIN	OPERATING INSTRUCTIONS DK/FIN
		218459410700		BEDIENUNGSANLEITUNG S/N	OPERATING INSTRUCTIONS S/N
		720100305000		SERVICE MANUAL D/GB	SERVICE MANUAL D/GB
		720100305400		SERVICE MANUAL D/GB 4.ERGAENZUNG	SERVICE MANUAL D/GB 4TH SUPPLEMENT
		720100305500		SERVICE MANUAL D/GB 5.ERGAENZUNG	SERVICE MANUAL D/GB 5TH SUPPLEMENT
		720100305600		SERVICE MANUAL D/GB 6.ERGAENZUNG	SERVICE MANUAL D/GB 6TH SUPPLEMENT
297040192800	X			CHASSIS-FS-STEREO CUC 1807 DIGI 100 KEIN E-TEIL	CHASSIS TV STEREO CUC 1807 DIGI 100 NO SPARE PART
				WW.-WAHLWEISE X-SIEHE GESONDERT E-LISTE	WW.-OPTIONAL X-SEE SEPARATE PARTS LIST
				ALLE WEITEREN TEILE SIEHE E-LISTE XENTIA 55 M 55-420/8 DOLBY PROCON SILBER MAT.-NR.: 921845024000 BESTELL-NR.: GCL8000 AUSGABE 9/2001 VERSION NR.: VNM	FOR ALL OTHER PARTS SEE XENTIA 55 M 55-420/8 DOLBY PROCON SILVER PART NO.: 921845024000 ORDER NR.: GCL8000 EDITION 9/2001 VERSION NO.: VNM

### XENTIA 55 M 55-420/8 DOLBY

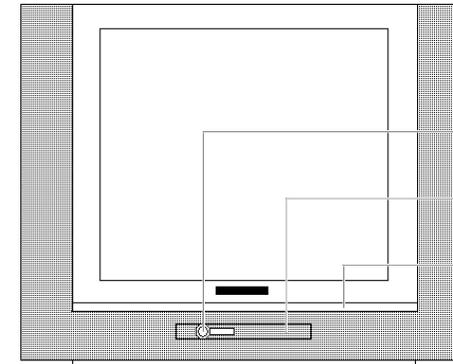

296353470401

295017590702 (VNM)  
295017590703 (VNA)

296365600501

296383190101

POS. NR. MATERIAL-NR. BEZEICHNUNG  
POS. NO. PART NUMBER DESCRIPTION

POS. NR. MATERIAL-NR. BEZEICHNUNG  
POS. NO. PART NUMBER DESCRIPTION

Es gelten die Vorschriften und Sicherheitshinweise gemäß dem Service Manual "Sicherheit", Mat.-Nummer 720108000000, sowie zusätzlich die eventuell abweichenden, landesspezifischen Vorschriften!



The regulations and safety instructions shall be valid as provided by the "Safety" Service Manual, part number 720108000000, as well as the respective national deviations.

# Ersatzteilliste Spare Parts List

# GRUNDIG

# TV

## 3 / 2002

## XENTIA 55 M 55-420/8 DOLBY

MATERIAL-NR. / PART NO.: 921845027700      BESTELL-NR. / ORDER NO.: GCL8077 ELON METALLIC  
VERSION NR./VERSION NO.: VNA

POS. NR. POS. NO.	ABB. FIG.	MATERIAL-NR. PART NUMBER	ANZ. QTY.	BEZEICHNUNG (D)	DESCRIPTION (GB)
		921845027700		XENTIA 55 M 55-420/8 DOLBY ELON METALLIC KEIN E-TEIL	XENTIA 55 M 55-420/8 DOLBY ELON METALLIC NO SPARE PART
0050.000				PROGRAMM FLASH-EPROM DOWNLOAD: WWW.GRUNDIG.DE/ PRODUKTE/KONTAKT/HAENDLERSERVICE	PROGRAM FLASH EPROM DOWNLOAD: WWW.GRUNDIG.DE/ PRODUCTS/CONTACT/RESELLER SUPPORT
0218.000		295017590703		RAHMEN M.TASTENKNOPF NETZ KPL TYPENAUFKLEBER VNA	FRAME W.KEY STRIP POWER CPL TYPE LABEL VNA
0320.000	△	291103016405		ENTMAGNETISIERUNGSSPULE M.HALTER	COIL DEGAUSSING W.HOLDER
0700.000		092461287510		SHIFTSTECKER KPL 4 W/120 OHM	SHIFT PLUG CPL 4 W/120 OHM
0950.000		292104087100		SHIFTSTECKER KPL 4W/220 OHM	SHIFT PLUG CPL 4W/220 OHM
WW.		296420614102		TP 100 C FERNBEDIENUNG GRAU	TP 100 C REMOTE CONTROL GREY
2400.000		296420614102		DECKEL BATTERIE TP 100 C	BATTERY LID TP 100 C
2410.000		720086730000			
		218459410200		BEDIENUNGSANLEITUNG D	OPERATING INSTRUCTIONS D
		218459410300		BEDIENUNGSANLEITUNG F/I	OPERATING INSTRUCTIONS F/I
		218459410400		BEDIENUNGSANLEITUNG GB/NL	OPERATING INSTRUCTIONS GB/NL
		218459410500		BEDIENUNGSANLEITUNG E/P	OPERATING INSTRUCTIONS E/P
		218459410600		BEDIENUNGSANLEITUNG DK/FIN	OPERATING INSTRUCTIONS DK/FIN
		218459410700		BEDIENUNGSANLEITUNG S/N	OPERATING INSTRUCTIONS S/N
		720100305000		SERVICE MANUAL D/GB	SERVICE MANUAL D/GB
		720100305400		SERVICE MANUAL D/GB 4. ERGAENZUNG	SERVICE MANUAL D/GB 4TH SUPPLEMENT
		720100305500		SERVICE MANUAL D/GB 5. ERGAENZUNG	SERVICE MANUAL D/GB 5TH SUPPLEMENT
		720100305600		SERVICE MANUAL D/GB 6. ERGAENZUNG	SERVICE MANUAL D/GB 6TH SUPPLEMENT
		297040192800	X	CHASSIS-FS-STEREO CUC 1807 DIGI 100 KEIN E-TEIL	CHASSIS TV STEREO CUC 1807 DIGI 100 NO SPARE PART
				WW.=WAHLWEISE X=SIEHE GESONDERTE E-LISTE	WW.=OPTIONAL X=SEE SEPARATE PARTS LIST
				ALLE WEITEREN TEILE SIEHE E-LISTE XENTIA 55 M 55-420/8 DOLBY ELON METALLIC MAT.-NR.: 921845027700 BESTELL-NR.: GCL8077 AUSGABE 2/2001 VERSION NR.: VNM	FOR ALL OTHER PARTS SEE XENTIA 55 M 55-420/8 DOLBY ELON METALLIC PART NO.: 921845027700 ORDER NR.: GCL8077 EDITION 2/2001 VERSION NO.: VNM

## XENTIA 55 M 55-420/8 DOLBY

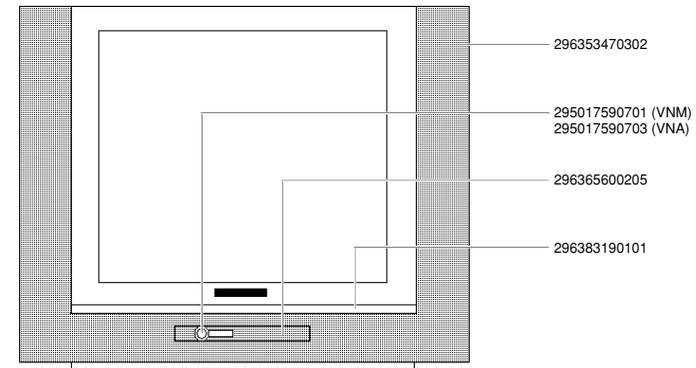

POS. NR. MATERIAL-NR. BEZEICHNUNG  
POS. NO. PART NUMBER DESCRIPTION

POS. NR. MATERIAL-NR. BEZEICHNUNG  
POS. NO. PART NUMBER DESCRIPTION

Es gelten die Vorschriften und Sicherheitshinweise gemäß dem Service Manual "Sicherheit", Mat.-Nummer 720108000000, sowie zusätzlich die eventuell abweichenden, landesspezifischen Vorschriften!



The regulations and safety instructions shall be valid as provided by the "Safety" Service Manual, part number 720108000000, as well as the respective national deviations.

ÄNDERUNGEN VORBEHALTEN / SUBJECT TO ALTERATION

ÄNDERUNGEN VORBEHALTEN / SUBJECT TO ALTERATION

Ersatzteilliste  
Spare Parts List

**GRUNDIG**

**TV**

**3 / 2002**

**ELEGANCE 63 ST 63-300 DOLBY**

MATERIAL-NR. / PART NO.: 921917014000 BESTELL-NR. / ORDER NO.: GCL0800 PROCON SILBER/PROCON SILVER  
VERSION NR./VERSION NO.: VNA

POS. NR. POS. NO.	ABB. FIG.	MATERIAL-NR. PART NUMBER	ANZ. QTY.	BEZEICHNUNG (D)	DESCRIPTION (GB)
		921917014000		ELEGANCE 63 ST 63-300 DOLBY PROCON SILBER KEIN E-TEIL	ELEGANCE 63 ST 63-300 DOLBY PROCON SILVER NO SPARE PART
0050.000				PROGRAMM FLASH-EPROM DOWNLOAD: WWW.GRUNDIG.DE/ PRODUKTE/KONTAKT/HAENDLERSERVICE	PROGRAM FLASH EPROM DOWNLOAD: WWW.GRUNDIG.DE/ PRODUCTS/CONTACT/RESELLER SUPPORT
0208.000		297006510103		ABDECKUNG DIGI-100	COVER DIGI-100
0240.000		293033904200		KOPFHOERERBUCHSE 3,5 O.SCHALTER	HEADPHONE SOCKET 3.5 W/O SWITCH
0241.000		293031680503		CINCH-BUCHSE 3-FACH FBAS/NF L,R	CINCH SOCKET 3 FOLD FBAS/AF L,R
0300.000		296367089103		GEH-RUECKTEIL	CABINET REAR PART
0320.000		291104526402		TYPENAUFKLEBER VNA	TYPE LABEL VNA
0950.000		292104087100		SHIFTSTECKER KPL 4 W/120 OHM	SHIFT PLUG CPL 4 W/120 OHM
0950.000		292104087406		SHIFTSTECKER KPL 4W/220 OHM	SHIFT PLUG CPL 4W/220 OHM
1300.000		295017610103		BEDIENEINSATZ MONTIERT KPL	CONTROL INSERT MOUNTED CPL
1354.000		296380230101	2	DAEMPFBLOCK	DAMPING BLOCK
1370.000		295017612102		TASTENKNOPF NETZ	KEY KNOB POWER
1371.000		293033750802		DRUCKFEDER TASTENKNOPF NETZ	PRESSURE SPRING KEY KNOB POWER
2400.000		296420660400		TP 150 C FERNBEDIENUNG GRAU	TP 150 C REMOTE CONTROL GREY
		219179412000		BEDIENUNGSANLEITUNG D	OPERATING INSTRUCTIONS D
		219179412100		BEDIENUNGSANLEITUNG F/I	OPERATING INSTRUCTIONS F/I
		219179412200		BEDIENUNGSANLEITUNG GB/NL	OPERATING INSTRUCTIONS GB/NL
		720100305000		SERVICE MANUAL D/GB	SERVICE MANUAL D/GB
		720100305400		SERVICE MANUAL D/GB 4.ERGAENZUNG	SERVICE MANUAL D/GB 4TH SUPPLEMENT
		720100305500		SERVICE MANUAL D/GB 5.ERGAENZUNG	SERVICE MANUAL D/GB 5TH SUPPLEMENT
		720100305600		SERVICE MANUAL D/GB 6.ERGAENZUNG	SERVICE MANUAL D/GB 6TH SUPPLEMENT

ALLE WEITEREN TEILE SIEHE E-LISTE  
ELEGANCE 63 ST 63-300 DOLBY  
PROCON SILBER  
MAT.-NR.: 921917014000  
BESTELL-NR.: GCL0800  
AUSGABE 5/2001  
VERSION NR.: VNM

FOR ALL OTHER PARTS SEE  
ELEGANCE 63 ST 63-300 DOLBY  
PROCON SILVER  
PART NO: 921917014000  
ORDER NR: GCL0800  
EDITION 5/2001  
VERSION NO.: VNM

POS. NR. MATERIAL-NR. BEZEICHNUNG  
POS. NO. PART NUMBER DESCRIPTION

POS. NR. MATERIAL-NR. BEZEICHNUNG  
POS. NO. PART NUMBER DESCRIPTION

**ELEGANCE 63 ST 63-300 DOLBY**

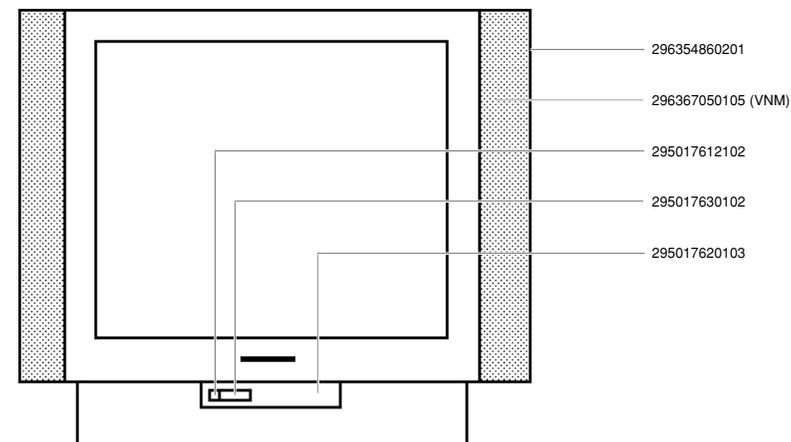

Es gelten die Vorschriften und Sicherheitshinweise gemäß dem Service Manual "Sicherheit", Mat.-Nummer 720108000000, sowie zusätzlich die eventuell abweichenden, landesspezifischen Vorschriften!



The regulations and safety instructions shall be valid as provided by the "Safety" Service Manual, part number 720108000000, as well as the respective national deviations.

ÄNDERUNGEN VORBEHALTEN / SUBJECT TO ALTERATION

ÄNDERUNGEN VORBEHALTEN / SUBJECT TO ALTERATION

# Ersatzteilliste Spare Parts List

# GRUNDIG

# TV

## 3 / 2002

## ELEGANCE 63 ST 63-300 DOLBY

MATERIAL-NR. / PART NO.: 921917014000 BESTELL-NR. / ORDER NO.: GCL0800 PROCON SILBER/PROCON SILVER  
VERSION NR./VERSION NO.: VNX

POS. NR. POS. NO.	ABB. FIG.	MATERIAL-NR. PART NUMBER	ANZ. QTY.	BEZEICHNUNG (D)	DESCRIPTION (GB)
		921917014000		ELEGANCE 63 ST 63-300 DOLBY PROCON SILBER KEIN E-TEIL	ELEGANCE 63 ST 63-300 DOLBY PROCON SILVER NO SPARE PART
0050.000				PROGRAMM FLASH-EPROM DOWNLOAD: WWW.GRUNDIG.DE/ PRODUKTE/KONTAKT/HAENDLERSERVICE	PROGRAM FLASH EPROM DOWNLOAD: WWW.GRUNDIG.DE/ PRODUCTS/CONTACT/RESELLER SUPPORT
0208.000	297006510103			ABDECKUNG DIGI-100	COVER DIGI-100
0225.000	295017620104			KLAPPE BEDIENTEIL DRUCK KPL	FLAP CONTROL UNIT PRINT CPL
0240.000	293033904200			KOPFHUERERBUCHSE 3,5 O.SCHALTER	HEADPHONE SOCKET 3.5 W/O SWITCH
0241.000	293031680503			CINCH-BUCHSE 3-FACH FBAS/NF L,R	CINCH SOCKET 3 FOLD FBAS/AF L,R
0300.000	296367089104			GEH-RUECKTEIL	CABINET REAR PART
0320.000	291104526502			TYPENAUFKLEBER VNX	TYPE LABEL VNX
0950.000	292104087100			SHIFTSTECKER KPL 4 W/120 OHM	SHIFT PLUG CPL 4 W/120 OHM
0950.000	292104087406			SHIFTSTECKER KPL 4W/220 OHM	SHIFT PLUG CPL 4W/220 OHM
1300.000	295017610104			BEDIENEINSATZ MONTIERT KPL	CONTROL INSERT MOUNTED CPL
1354.000	296380230101	2		DAEMPFUNGSBLOCK	DAMPING BLOCK
1370.000	295017612102			TASTENKNOPF NETZ	KEY KNOB POWER
1371.000	293033750802			DRUCKFEDER TASTENKNOPF NETZ	PRESSURE SPRING KEY KNOB POWER
2400.000	296420660400			TP 150 C FERNBEDIENUNG GRAU	TP 150 C REMOTE CONTROL GREY
	219179412000			BEDIENUNGSANLEITUNG D	OPERATING INSTRUCTIONS D
	219179412100			BEDIENUNGSANLEITUNG F/I	OPERATING INSTRUCTIONS F/I
	219179412200			BEDIENUNGSANLEITUNG GB/NL	OPERATING INSTRUCTIONS GB/NL
	720100305000			SERVICE MANUAL D/GB	SERVICE MANUAL D/GB
	720100305400			SERVICE MANUAL D/GB 4.ERGAENZUNG	SERVICE MANUAL D/GB 4TH SUPPLEMENT
	720100305500			SERVICE MANUAL D/GB 5.ERGAENZUNG	SERVICE MANUAL D/GB 5TH SUPPLEMENT
	720100305600			SERVICE MANUAL D/GB 6.ERGAENZUNG	SERVICE MANUAL D/GB 6TH SUPPLEMENT
	297040191600	X		CHASSIS-FS-STEREO DIGI 100 CUC 1837 KEIN E-TEIL	CHASSIS TV STEREO DIGI 100 CUC 1837 NO SPARE PART
				X = SIEHE GESONDERTE E-LISTE	X = SEE SEPARATE PARTS LIST
				ALLE WEITEREN TEILE SIEHE E-LISTE ELEGANCE 63 ST 63-300 DOLBY PROCON SILBER MAT.-NR.: 921917014000 BESTELL-NR.: GCL0800 AUSGABE 5/2001 VERSION NR.: VNM	FOR ALL OTHER PARTS SEE ELEGANCE 63 ST 63-300 DOLBY PROCON SILVER PART NO.: 921917014000 ORDER NR.: GCL0800 EDITION 5/2001 VERSION NO.: VNM

6

## ELEGANCE 63 ST 63-300 DOLBY

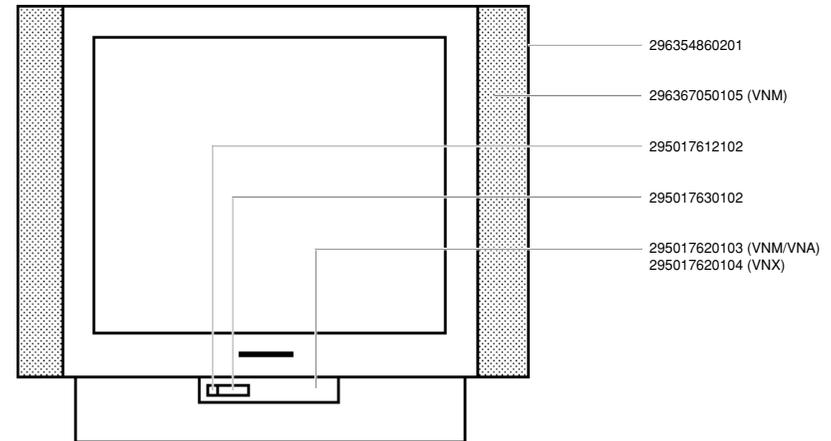

Es gelten die Vorschriften und Sicherheitshinweise gemäß dem Service Manual "Sicherheit", Mat.-Nummer 720108000000, sowie zusätzlich die eventuell abweichenden, landesspezifischen Vorschriften!



The regulations and safety instructions shall be valid as provided by the "Safety" Service Manual, part number 720108000000, as well as the respective national deviations.

ÄNDERUNGEN VORBEHALTEN / SUBJECT TO ALTERATION

ÄNDERUNGEN VORBEHALTEN / SUBJECT TO ALTERATION

Ersatzteilliste  
Spare Parts List

10 / 2001

## ELEGANCE 63 ST 63-300 DOLBY

MATERIAL-NR. / PART NO.: 921917016900 BESTELL-NR. / ORDER NO.: GCL0820 TESSA BLACK  
VERSION NR./VERSION NO.: VNA

POS. NR. POS. NO.	ABB. FIG.	MATERIAL-NR. PART NUMBER	ANZ. QTY.	BEZEICHNUNG (D)	DESCRIPTION (GB)
		921917016900		ELEGANCE 63 ST 63-300 DOLBY TESSA BLACK KEIN E-TEIL	ELEGANCE 63 ST 63-300 DOLBY TESSA BLACK NO SPARE PART
0050.000		297981110800		PROGRAMM FLASH-EPROM DOWNLOAD: WWW.GRUNDIG.DE/ PRODUKTE/KONTAKT/HAENDLERSERVICE	PROGRAM FLASH EPROM DOWNLOAD: WWW.GRUNDIG.DE/ PRODUKTE/KONTAKT/HAENDLERSERVICE
0200.000		296354860101		GEH-VORDERTEIL DRUCK KPL	CABINET FRONT PART PRINT CPL
0201.000		191260359701	2	LAUTSPRECHER	LOUDSPEAKER
0217.000		296088640102	5	SOCKELEINLAGE	BASE INSERT
0240.000		293033904200		KOPFHUERERBUCHSE 3.5 O.SCHALTER	HEADPHONE SOCKET 3,5 W/O SWITCH
0241.000		293031680503		CINCH-BUCHSE 3-FACH FBAS/NF L,R	CINCH SOCKET 3 FOLD FBAS/AF L,R
0300.000		296367808501		GEH-RUECKTEIL OFB	CABINET REAR PART SURFACE TREATED
0312.000		297006510103		ABDECKUNG DIGI-100	COVER DIGI-100
0312.000		297006530101		ABDECKUNG FLASH	COVER FLASH
0320.000		291104526402		TYPENAUFKLEBER VNA	TYPE LABEL VNA
0700.000	△	092461307601		ENTMAGNETISIERUNGSSPULE M.HALTER	DEGAUSSING COIL W.HOLDER
0750.000		296364810102	4	BEFESTIGUNGS-EINSATZ BILDROHR	HOLDER INSERT PICTURE TUBE
0950.000		292104087100		SHIFTSTECKER KPL 4 W/120 OHM	SHIFTSTECKER CPL 4 W/120 OHM
0950.000		292104087406		SHIFTSTECKER KPL 4W/220 OHM	SHIFT PLUG CPL 4W/220 OHM
1100.000		830002041200		BILDOR.A59EAK071X44 PHILIPS	PICT.TUBE A59EAK071X44 PHILIPS
1110.000	△	292013600211		ANODENKAPPE M.HOCHSPANNUNGSKABEL	ANODE CAP W.HIGH VOLTAGE CABLE
1301.000		295017610103		BEDIENEINSATZ MONT.KPL	CONTROL INSERT MOUNT.CPL
1352.000		295017620201		KLAPPE DRUCK KPL	FLAP PRINT CPL
1353.000		270332210100		DRUCKSCHNAPPEPPEP	PRESSURE CATCH
1354.000		296380230101	2	DAEMPFUNGSBLOCK	DAMPING BLOCK
1370.000		295017612102		NETZTASTENKNOPF	KNOB KEY POWER
1371.000		293033750802		DRUCKFEDER NETZTASTENKNOPF	PRESSURE SPRING KNOB KEY POWER
1382.000		295017630102		IR-FENSTER	IR WINDOW
2100.000	△	829099131600		NETZKABEL KPL	POWER CABLE CPL
2300.000		293051223100	X	BILDROHRPLATTE	PICT.TUBE BOARD
2400.000		296420660300		TP 150 C FERNBEDIENUNG	TP 150 C REMOTE CONTROL
		219179412000		BEDIENUNGSANLEITUNG D	OPERATING INSTRUCTIONS D
		219179412100		BEDIENUNGSANLEITUNG F/I	OPERATING INSTRUCTIONS F/I
		219179412200		BEDIENUNGSANLEITUNG GB/NL	OPERATING INSTRUCTIONS GB/NL
		720100305000		SERVICE MANUAL D/GB	SERVICE MANUAL D/GB
		720100305200		SERVICE MANUAL D/GB 2.ERGAENZUNG	SERVICE MANUAL D/GB 2ND SUPPLEMENT
		720100305300		SERVICE MANUAL D/GB 3.ERGAENZUNG	SERVICE MANUAL D/GB 3RD SUPPLEMENT
		296560044200		MONTAGEZUBEHOER F.BILDROHR KEIN E-TEIL	MOUNTING ACCESSORIES F.P.T NO SPARE PART
		297040114100	X	CHASSIS-FS-STEREO CUC 1837 DIGI 100 KEIN E-TEIL	CHASSIS TV STEREO CUC 1837 DIGI 100 NO SPARE PART
				X=SIHE GESONDERTE E-LISTE	X=SEE SEPARATE PARTS LIST

ÄNDERUNGEN VORBEHALTEN / SUBJECT TO ALTERATION

POS. NR. MATERIAL-NR. BEZEICHNUNG  
POS. NO. PART NUMBER DESCRIPTIONPOS. NR. MATERIAL-NR. BEZEICHNUNG  
POS. NO. PART NUMBER DESCRIPTION

## ELEGANCE 63 ST 63-300 DOLBY

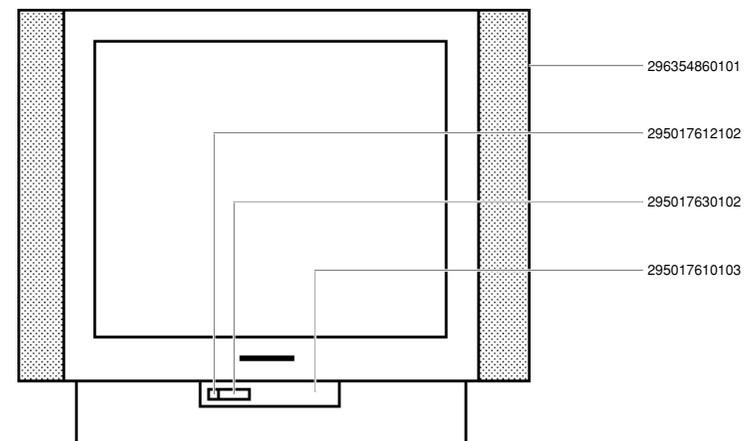

Es gelten die Vorschriften und Sicherheitshinweise gemäß dem Service Manual "Sicherheit", Mat.-Nummer 720108000000, sowie zusätzlich die eventuell abweichenden, landesspezifischen Vorschriften!



The regulations and safety instructions shall be valid as provided by the "Safety" Service Manual, part number 720108000000, as well as the respective national deviations.

ÄNDERUNGEN VORBEHALTEN / SUBJECT TO ALTERATION

## 4 / 2002

## ELEGANCE 63 ST 63-300 DOLBY

MATERIAL-NR. / PART NO.: 921917016900 BESTELL-NR. / ORDER NO.: GCL0820 TESSA BLACK  
VERSION NR./VERSION NO.: VNX

POS. NR. POS. NO.	ABB. FIG.	MATERIAL-NR. PART NUMBER	ANZ. QTY.	BEZEICHNUNG ①	DESCRIPTION ②
		921917016900		ELEGANCE 63 ST 63-300 DOLBY TESSA BLACK KEIN E-TEIL	ELEGANCE 63 ST 63-300 DOLBY TESSA BLACK NO SPARE PART
0050.000				PROGRAMM FLASH-EPROM DOWNLOAD: WWW.GRUNDIG.DE/ PRODUKTE/KONTAKT/HAENDLERSERVICE	PROGRAM FLASH EPROM DOWNLOAD: WWW.GRUNDIG.DE/ PRODUCTS/CONTACT/RESELLER SUPPORT
0320.000		291104526502		TYPENAUFKLEBER VNX	TYPE LABEL VNX
1301.000		295017610104		BEDIENEINSATZ MONT.KPL	CONTROL INSERT MOUNT.CPL
1350.000		295017660102		TASTEN-SATZ PROGRAMM/LAUTSTAERKE	KEYS SET PROGRAMME/VOLUME
1352.000		295017620202		KLAPPE DRUCK KPL	FLAP PRINT CPL
		219179412000		BEDIENUNGSANLEITUNG D	OPERATING INSTRUCTIONS D
		219179412100		BEDIENUNGSANLEITUNG F/I	OPERATING INSTRUCTIONS F/I
		219179412200		BEDIENUNGSANLEITUNG GB/NL	OPERATING INSTRUCTIONS GB/NL
		720100305000		SERVICE MANUAL D/GB	SERVICE MANUAL D/GB
		720100305400		SERVICE MANUAL D/GB 4.ERGAENZUNG	SERVICE MANUAL D/GB 4TH SUPPLEMENT
		720100305500		SERVICE MANUAL D/GB 5.ERGAENZUNG	SERVICE MANUAL D/GB 5TH SUPPLEMENT
		720100305600		SERVICE MANUAL D/GB 6.ERGAENZUNG	SERVICE MANUAL D/GB 6TH SUPPLEMENT
		297040191600	X	CHASSIS-FS-STEREO CUC 1837 DIGI 100 KEIN E-TEIL	CHASSIS TV STEREO CUC 1837 DIGI 100 NO SPARE PART
				X=SIEHE GESONDERTE E-LISTE	X=SEE SEPARATE PARTS LIST
				ALLE WEITEREN TEILE SIEHE E-LISTE ELEGANCE 63 ST 63-300 DOLBY TESSA BLACK MAT.-NR.: 921917016900 BESTELL-NR.: GCL0820 AUSGABE 10/2001 VERSION NR.: VNA	FOR ALL OTHER PARTS SEE ELEGANCE 63 ST 63-300 DOLBY TESSA BLACK PART NO: 921917016900 ORDER NR: GCL0820 EDITION 10/2001 VERSION NO.: VNA

Es gelten die Vorschriften und Sicherheitshinweise gemäß dem Service Manual "Sicherheit", Mat.-Nummer 720108000000, sowie zusätzlich die eventuell abweichenden, landesspezifischen Vorschriften!



The regulations and safety instructions shall be valid as provided by the "Safety" Service Manual, part number 720108000000, as well as the respective national deviations.

ÄNDERUNGEN VORBEHALTEN / SUBJECT TO ALTERATION

## Ersatzteilliste Spare Parts List

4 / 2002

## ELEGANCE 63 ST 63-300/8 DOLBY

MATERIAL-NR. / PART NO.: 921917024000 BESTELL-NR. / ORDER NO.: GCK9800 PROCON SILBER/PROCON SILVER  
VERSION NR./VERSION NO.: **VNA**

POS. NR. POS. NO.	ABB. FIG.	MATERIAL-NR. PART NUMBER	ANZ. QTY.	BEZEICHNUNG (D)	DESCRIPTION (GB)
----------------------	--------------	-----------------------------	--------------	--------------------	---------------------

VERSION NR. : <b>VNA</b>				VERSION NO. : <b>VNA</b>	
		921917024000		ELEGANCE 63 ST 63-300/8 DOLBY PROCON SILBER KEIN E-TEIL	ELEGANCE 63 ST 63-300/8 DOLBY PROCON SILVER NO SPARE PART
0050.000				PROGRAMM FLASH-EPROM DOWNLOAD: WWW.GRUNDIG.DE/ PRODUKTE/KONTAKT/HAENDLERSERVICE	PROGRAMM FLASH EPROM DOWNLOAD: WWW.GRUNDIG.DE/ PRODUCTS/CONTACT/RESELLER SUPPORT
0240.000		293033904200		KOPFHOERERBUCHSE 3,5 O.SCHALTER	HEADPHONE SOCKET 3,5 W/O SWITCH
0241.000		293031680503		CINCH-BUCHSE 3-FACH FBAS/NF L,R	CINCH SOCKET 3 FOLD FBAS/AF L,R
0300.000		296367089103		GEH-RUECKTEIL	CABINET REAR PART
0312.000		297006510103		ABDECKUNG DIGI-100	COVER DIGI-100
0320.000		291104536402		TYPENAUFKLEBER VNA	TYPE LABEL VNA
0950.000		292104087100		SHIFTSTECKER KPL 4 W/120 OHM	SHIFT PLUG CPL 4 W/120 OHM
0950.000		292104087406		SHIFTSTECKER KPL 4W/220 OHM	SHIFT PLUG CPL 4W/220 OHM
1350.000		295017660102		TASTEN-SATZ PROGRAMM/LAUTSTAERKE	KEYS SET PROGRAMME/VOLUME
1353.000		270332210100		DRUCKSCHNAEPFER	PRESSURE CATCH
1354.000		296380230101	2	DAEMPFBLOCK	DAMPING BLOCK
1370.000		295017612102		TASTENKNOPF NETZ	KEY KNOB POWER
1371.000		293033750802		DRUCKFEDER TASTENKNOPF NETZ	PRESSURE SPRING KEY KNOB POWER
2400.000		296420660400		TP 150 C FERNBEDIENUNG GRAU	TP 150 C REMOTE CONTROL GREY
		219179411300		BEDIENUNGSANLEITUNG D	OPERATING INSTRUCTIONS D
		219179411400		BEDIENUNGSANLEITUNG F/I	OPERATING INSTRUCTIONS F/I
		219179411500		BEDIENUNGSANLEITUNG GB/NL	OPERATING INSTRUCTIONS GB/NL
		219179411600		BEDIENUNGSANLEITUNG E/P	OPERATING INSTRUCTIONS E/P
		219179411700		BEDIENUNGSANLEITUNG DK/FIN	OPERATING INSTRUCTIONS DK/FIN
		219179411800		BEDIENUNGSANLEITUNG S/N	OPERATING INSTRUCTIONS S/N
		720100305000		SERVICE MANUAL D/GB	SERVICE MANUAL D/GB
		720100305400		SERVICE MANUAL D/GB 4. ERGAENZUNG	SERVICE MANUAL D/GB 4TH SUPPLEMENT
		720100305500		SERVICE MANUAL D/GB 5. ERGAENZUNG	SERVICE MANUAL D/GB 5TH SUPPLEMENT
		720100305600		SERVICE MANUAL D/GB 6. ERGAENZUNG	SERVICE MANUAL D/GB 6TH SUPPLEMENT

ALLE WEITEREN TEILE SIEHE E-LISTE  
ELEGANCE 63 ST 63-300/8 DOLBY  
PROCON SILBER  
MAT.-NR.: 921917024000  
BESTELL-NR.: GCK9800  
AUSGABE 5/2001  
VERSION NR.: **VNM**

FOR ALL OTHER PARTS SEE  
ELEGANCE 63 ST 63-300/8 DOLBY  
PROCON SILVER  
PART NO.: 921917024000  
ORDER NR.: GCK9800  
EDITION 5/2001  
VERSION NO.: **VNM**

## ELEGANCE 63 ST 63-300/8 DOLBY

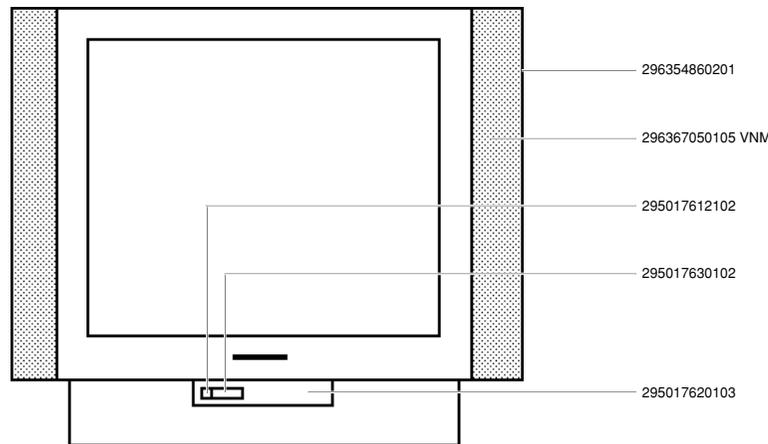

Es gelten die Vorschriften und Sicherheitshinweise gemäß dem Service Manual "Sicherheit", Mat.-Nummer 720108000000, sowie zusätzlich die eventuell abweichenden, landesspezifischen Vorschriften!



The regulations and safety instructions shall be valid as provided by the "Safety" Service Manual, part number 720108000000, as well as the respective national deviations.

ÄNDERUNGEN VORBEHALTEN / SUBJECT TO ALTERATION

ÄNDERUNGEN VORBEHALTEN / SUBJECT TO ALTERATION

**GRUNDIG****TV**Ersatzteilliste  
Spare Parts List**4 / 2002****ELEGANCE 63 ST 63-300/8 DOLBY**MATERIAL-NR. / PART NO.: 921917024000 BESTELL-NR. / ORDER NO.: GCK9800 PROCON SILBER/PROCON SILVER  
VERSION NR./VERSION NO.: VNX

POS. NR. POS. NO.	ABB. FIG.	MATERIAL-NR. PART NUMBER	ANZ. QTY.	BEZEICHNUNG (D)	DESCRIPTION (GB)
		921917024000		ELEGANCE 63 ST 63-300/8 DOLBY PROCON SILBER KEIN E-TEIL	ELEGANCE 63 ST 63-300/8 DOLBY PROCON SILVER NO SPARE PART
0050.000				PROGRAMM FLASH-EPROM DOWNLOAD: WWW.GRUNDIG.DE/ PRODUKTE/KONTAKT/HAENDLERSERVICE	PROGRAM FLASH EPROM DOWNLOAD: WWW.GRUNDIG.DE/ PRODUCTS/CONTACT/RESELLER SUPPORT
0240.000	293033904200			KOPFHOERERBUCHSE 3,5 O.SCHALTER	HEADPHONE SOCKET 3,5 W/O SWITCH
0241.000	293031680503			CINCH-BUCHSE 3-FACH FBAS/NF L,R	CINCH SOCKET 3 FOLD FBAS/AF L,R
0300.000	296367089104			GEH-RUECKTEIL	CABINET REAR PART
0312.000	297006510103			ABDECKUNG DIGI-100	COVER DIGI-100
0320.000	291104536502			TYPENAUFLIEBER VNX	TYPE LABEL VNX
0950.000	292104087100			SHIFTSTECKER KPL 4 W/120 OHM	SHIFT PLUG CPL 4 W/120 OHM
0950.000	292104087406			SHIFTSTECKER KPL 4W/220 OHM	SHIFT PLUG CPL 4W/220 OHM
1300.000	295017610104			BEDIENEINSATZ MONT.KPL	CONTROL INSERT MOUNT.CPL
1350.000	295017660102			TASTEN-SATZ PROGRAMM/LAUTSTAERKE	KEYS SET PROGRAMME/VOLUME
1352.000	295017620104			KLAPPE DRUCK KPL	FLAP PRINT CPL
1353.000	270332210100			DRUCKSCHNAPPEPPE	PRESSURE CATCH
1354.000	296380230101			DAEMPFUNGSBLOCK	DAMPING BLOCK
1370.000	295017612102			TASTENKNOPF NETZ	KEY KNOB POWER
1371.000	293033750802			DRUCKFEDER TASTENKNOPF NETZ	PRESSURE SPRING KEY KNOB POWER
2400.000	296420660400			TP 150 C FERNBEDIENUNG GRAU	TP 150 C REMOTE CONTROL GREY
	219179411300			BEDIENUNGSANLEITUNG D	OPERATING INSTRUCTIONS D
	219179411400			BEDIENUNGSANLEITUNG F/I	OPERATING INSTRUCTIONS F/I
	219179411500			BEDIENUNGSANLEITUNG GB/NL	OPERATING INSTRUCTIONS GB/NL
	219179411600			BEDIENUNGSANLEITUNG E/P	OPERATING INSTRUCTIONS E/P
	219179411700			BEDIENUNGSANLEITUNG DK/FIN	OPERATING INSTRUCTIONS DK/FIN
	219179411800			BEDIENUNGSANLEITUNG S/N	OPERATING INSTRUCTIONS S/N
	720100305000			SERVICE MANUAL D/GB	SERVICE MANUAL D/GB
	720100305400			SERVICE MANUAL D/GB 4.ERGAENZUNG	SERVICE MANUAL D/GB 4TH SUPPLEMENT
	720100305500			SERVICE MANUAL D/GB 5.ERGAENZUNG	SERVICE MANUAL D/GB 5TH SUPPLEMENT
	297040191700	X		CHASSIS-FS-STEREO DIGI 100 CUC 1837 KEIN E-TEIL	CHASSIS TV STEREO DIGI 100 CUC 1837 NO SPARE PART
				X=SIEHE GESONDERTE E-LISTE	X=SEE SEPARATE PARTS LIST
				ALLE WEITEREN TEILE SIEHE E-LISTE ELEGANCE 63 ST 63-300/8 DOLBY PROCON SILBER MAT.-NR.: 921917024000 BESTELL-NR.: GCK9800 AUSGABE 5/2001 VERSION NR.: VNM	FOR ALL OTHER PARTS SEE ELEGANCE 63 ST 63-300/8 DOLBY PROCON SILVER PART NO: 921917024000 ORDER NR: GCK9800 EDITION 5/2001 VERSION NO.: VNM

ÄNDERUNGEN VORBEHALTEN / SUBJECT TO ALTERATION

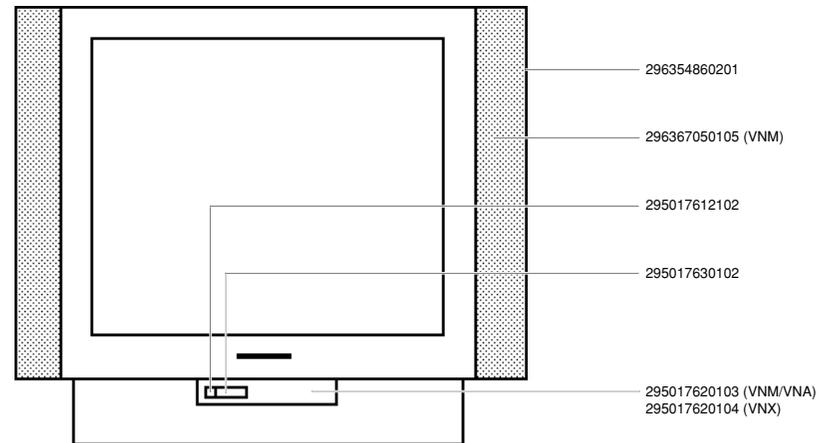
POS. NR. MATERIAL-NR. BEZEICHNUNG  
POS. NO. PART NUMBER DESCRIPTIONPOS. NR. MATERIAL-NR. BEZEICHNUNG  
POS. NO. PART NUMBER DESCRIPTION**ELEGANCE 63 ST 63-300/8 DOLBY**Es gelten die Vorschriften und Sicherheitshinweise  
gemäß dem Service Manual "Sicherheit", Mat.-Num-  
mer 720108000000, sowie zusätzlich die eventuell ab-  
weichenden, landesspezifischen Vorschriften!The regulations and safety instructions shall be valid  
as provided by the "Safety" Service Manual, part  
number 720108000000, as well as the respective  
national deviations.

ÄNDERUNGEN VORBEHALTEN / SUBJECT TO ALTERATION

POS. NR. POS. NO.	ABB. FIG.	MATERIAL-NR. PART NUMBER	ANZ. QTY.	BEZEICHNUNG (D)	DESCRIPTION (GB)
		921917029200		ELEGANCE 63 ST 63-300/8 DOLBY TITANE KEIN E-TEIL	ELEGANCE 63 ST 63-300/8 DOLBY TITANE NO SPARE PART
0050.000				PROGRAMM FLASH-EPROM DOWNLOAD: WWW.GRUNDIG.DE/ PRODUKTE/KONTAKT/HAENDLERSERVICE	PROGRAM FLASH EPROM DOWNLOAD: WWW.GRUNDIG.DE/ PRODUCTS/CONTACT/RESELLER SUPPORT
0208.000		297006510103		ABDECKUNG DIGI-100	COVER DIGI-100
0240.000		293033904200		KOPFHUERERBUCHSE 3,5 O.SCHALTER	HEADPHONE SOCKET 3,5 W/O SWITCH
0241.000		293031680503		CINCH-BUCHSE 3-FACH FBAS/NF L,R	CINCH SOCKET 3 FOLD FBAS/AF L,R
0320.000		291104536402		TYPENAUFKLEBER VNA	TYPE LABEL VNA
0950.000		292104087100		SHIFTSTECKER KPL 4 W/120 OHM	SHIFT PLUG CPL 4 W/120 OHM
0950.000		292104087406		SHIFTSTECKER KPL 4W/220 OHM	SHIFT PLUG CPL 4W/220 OHM
1300.000		295017610103		BEDIENEINSATZ MONTIERT KPL	CONTROL INSERT MOUNTED CPL
1350.000		295017660102		TASTEN-SATZ PROGRAMM/LAUTSTAEERKE	KEYS SET PROGRAMME/VOLUME
1354.000		296380230101	2	DAEMPFUNGSBLOCK	DAMPING BLOCK
1370.000		295017612102		TASTENKNOPF NETZ	KEY KNOB POWER
1371.000		293033750802		DRUCKFEDER TASTENKNOPF NETZ	PRESSURE SPRING KEY KNOB POWER
2400.000		296420660300		TP 150 C FERNBEDIENUNG SCHWARZ	TP 150 C REMOTE CONTROL BLACK
2410.000		720086745000		DECKEL BATTERIE TP 150 C	BATTERY LID TP 150 C
		219179411300		BEDIENUNGSANLEITUNG D	OPERATING INSTRUCTIONS D
		219179411400		BEDIENUNGSANLEITUNG F/I	OPERATING INSTRUCTIONS F/I
		219179411500		BEDIENUNGSANLEITUNG GB/NL	OPERATING INSTRUCTIONS GB/NL
		219179411600		BEDIENUNGSANLEITUNG E/P	OPERATING INSTRUCTIONS E/P
		219179411700		BEDIENUNGSANLEITUNG DK/FIN	OPERATING INSTRUCTIONS DK/FIN
		219179411800		BEDIENUNGSANLEITUNG S/N	OPERATING INSTRUCTIONS S/N
		720100305000		SERVICE MANUAL D/GB	SERVICE MANUAL D/GB
		720100305400		SERVICE MANUAL D/GB 4. ERGAENZUNG	SERVICE MANUAL D/GB 4TH SUPPLEMENT
		720100305500		SERVICE MANUAL D/GB 5. ERGAENZUNG	SERVICE MANUAL D/GB 5TH SUPPLEMENT
		720100305600		SERVICE MANUAL D/GB 6. ERGAENZUNG	SERVICE MANUAL D/GB 6TH SUPPLEMENT
				ALLE WEITEREN TEILE SIEHE E-LISTE ELEGANCE 63 ST 63-300/8 DOLBY TITANE MAT.-NR.: 921917029200 BESTELL-NR.: GCK9810 AUSGABE 5/2001 VERSION NR.: VNM	FOR ALL OTHER PARTS SEE ELEGANCE 63 ST 63-300/8 DOLBY TITANE PART NO.: 921917029200 ORDER NR.: GCK9810 EDITION 5/2001 VERSION NO.: VNM

POS. NR. MATERIAL-NR. BEZEICHNUNG  
POS. NO. PART NUMBER DESCRIPTION

POS. NR. MATERIAL-NR. BEZEICHNUNG  
POS. NO. PART NUMBER DESCRIPTION

## ELEGANCE 63 ST 63-300/8 DOLBY

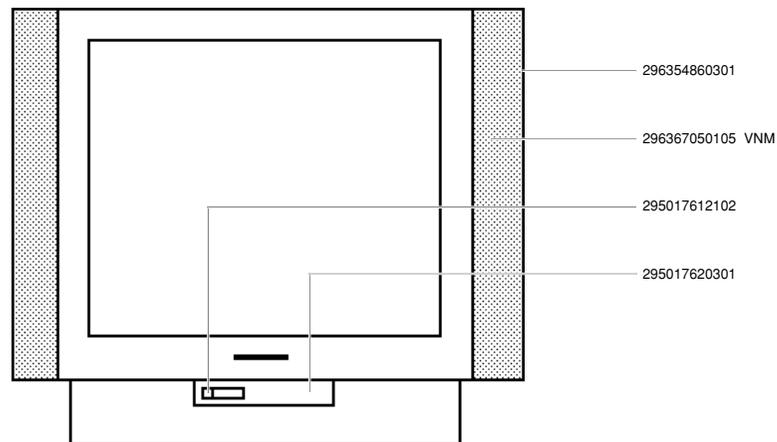

Es gelten die Vorschriften und Sicherheitshinweise gemäß dem Service Manual "Sicherheit", Mat.-Nummer 720108000000, sowie zusätzlich die eventuell abweichenden, landesspezifischen Vorschriften!



The regulations and safety instructions shall be valid as provided by the "Safety" Service Manual, part number 720108000000, as well as the respective national deviations.

## Ersatzteilliste Spare Parts List

6 / 2002

## ELEGANCE 63 ST 63-300/8 DOLBY

MATERIAL-NR. / PART NO.: 921917029200 BESTELL-NR. / ORDER NO.: GCK9810 TITANE  
VERSION NR./VERSION NO.: VNX

POS. NR. POS. NO.	ABB. FIG.	MATERIAL-NR. PART NUMBER	ANZ. QTY.	BEZEICHNUNG (D)	DESCRIPTION (GB)
				VERSION NR.: VNX	VERSION NO.: VNX
		921917029200		ELEGANCE 63 ST 63-300/8 DOLBY TITANE KEIN E-TEIL	ELEGANCE 63 ST 63-300/8 DOLBY TITANE NO SPARE PART
0050.000				PROGRAMM FLASH-EPROM DOWNLOAD: WWW.GRUNDIG.DE/ PRODUKTE/KONTAKT/HAENDLERSERVICE	PROGRAM FLASH EPROM DOWNLOAD: WWW.GRUNDIG.DE/ PRODUCTS/CONTACT/RESELLER SUPPORT
0208.000		297006510104		ABDECKUNG DIGI-100	COVER DIGI-100
0225.000		295017620302		KLAPPE DRUCK KPL	FLAP PRINT CPL
0240.000		293033904200		KOPFHUERERBUCHSE 3,5 O.SCHALTER	HEADPHONE SOCKET 3,5 W/O SWITCH
0241.000		293031680503		CINCH-BUCHSE 3-FACH FBAS/NF L,R	CINCH SOCKET 3 FOLD FBAS/AF L,R
0300.000		296367080302		GEH-RUECKTEIL OFB	CABINET REAR PART SURFACE TREATED
0320.000		291104536502		TYPENAUFKLEBER VNX	TYPE LABEL VNX
0950.000		292104087100		SHIFTSTECKER KPL 4 W/120 OHM	SHIFT PLUG CPL 4 W/120 OHM
0950.000		292104087406		SHIFTSTECKER KPL 4W/220 OHM	SHIFT PLUG CPL 4W/220 OHM
1300.000		295017610104		BEDIENEINSATZ MONTIERT KPL	CONTROL INSERT MOUNTED CPL
1350.000		295017660102		TASTEN-SATZ PROGRAMM/LAUTSTAERKE	KEYS SET PROGRAMME/VOLUME
1354.000		296380230101	2	DAEMPFBLOCK	DAMPING BLOCK
1370.000		295017612102		TASTENKNOPF NETZ	KEY KNOB POWER
1371.000		293033750802		DRUCKFEDER TASTENKNOPF NETZ	PRESSURE SPRING KEY KNOB POWER
2400.000		296420660300		TP 150 C FERNBEDIENUNG SCHWARZ	TP 150 C REMOTE CONTROL BLACK
2410.000		720086745000		DECKEL BATTERIE TP 150 C	BATTERY LID TP 150 C
		219179411300		BEDIENUNGSANLEITUNG D	OPERATING INSTRUCTIONS D
		219179411400		BEDIENUNGSANLEITUNG F/I	OPERATING INSTRUCTIONS F/I
		219179411500		BEDIENUNGSANLEITUNG GB/NL	OPERATING INSTRUCTIONS GB/NL
		219179411600		BEDIENUNGSANLEITUNG E/P	OPERATING INSTRUCTIONS E/P
		219179411700		BEDIENUNGSANLEITUNG DK/FIN	OPERATING INSTRUCTIONS DK/FIN
		219179411800		BEDIENUNGSANLEITUNG S/N	OPERATING INSTRUCTIONS S/N
		720100305000		SERVICE MANUAL D/GB	SERVICE MANUAL D/GB
		720100305400		SERVICE MANUAL D/GB 4.ERGAENZUNG	SERVICE MANUAL D/GB 4TH SUPPLEMENT
		720100305500		SERVICE MANUAL D/GB 5.ERGAENZUNG	SERVICE MANUAL D/GB 5TH SUPPLEMENT
		720100305600		SERVICE MANUAL D/GB 6.ERGAENZUNG	SERVICE MANUAL D/GB 6TH SUPPLEMENT
		297040191700	X	CHASSIS-FS-STEREO CUC 1837 DIGI 100 KEIN E-TEIL	CHASSIS TV STEREO CUC 1837 DIGI 100 NO SPARE PART
				X=SIEHE GESONDERTE E-LISTE	X=SEE SEPARATE PARTS LIST
				ALLE WEITEREN TEILE SIEHE E-LISTE ELEGANCE 63 ST 63-300/8 DOLBY TITANE MAT.-NR.: 921917029200 BESTELL-NR.: GCK9810 AUSGABE 5/2001 VERSION NR.: VNM	FOR ALL OTHER PARTS SEE ELEGANCE 63 ST 63-300/8 DOLBY TITANE PART NO: 921917029200 ORDER NR: GCK9810 EDITION 5/2001 VERSION NO.: VNM

POS. NR. MATERIAL-NR. BEZEICHNUNG  
POS. NO. PART NUMBER DESCRIPTION

POS. NR. MATERIAL-NR. BEZEICHNUNG  
POS. NO. PART NUMBER DESCRIPTION

## ELEGANCE 63 ST 63-300/8 DOLBY

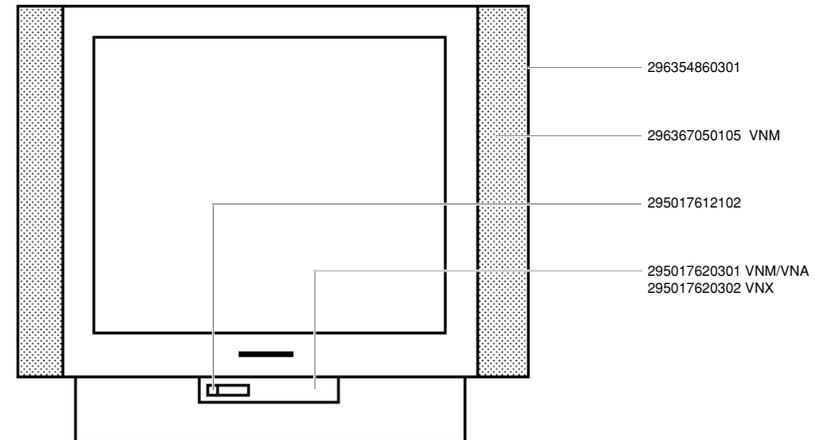

Es gelten die Vorschriften und Sicherheitshinweise gemäß dem Service Manual "Sicherheit", Mat.-Nummer 720108000000, sowie zusätzlich die eventuell abweichenden, landesspezifischen Vorschriften!



The regulations and safety instructions shall be valid as provided by the "Safety" Service Manual, part number 720108000000, as well as the respective national deviations.

ÄNDERUNGEN VORBEHALTEN / SUBJECT TO ALTERATION

ÄNDERUNGEN VORBEHALTEN / SUBJECT TO ALTERATION

Ersatzteilliste  
Spare Parts List**GRUNDIG****TV****9 / 2001****XENTIA 63 M 63-420/8 DOLBY**MATERIAL-NR. / PART NO.: 921852024000 BESTELL-NR. / ORDER NO.: GCI8300 PROCON SILBER/PROCON SILVER  
VERSION NR./VERSION NO.: VNA

POS. NR. POS. NO.	ABB. FIG.	MATERIAL-NR. PART NUMBER	ANZ. QTY.	BEZEICHNUNG (D)	DESCRIPTION (GB)
		921852024000		XENTIA 63 M 63-420/8 DOLBY KEIN E-TEIL	XENTIA 63 M 63-420/8 DOLBY NO SPARE PART
0200.000		296352890301		GEH-VORDERTEIL DRUCK KPL	CABINET FRONT PART PRINT
0201.000		191260460500	2	LAUTSPRECHER KOMBI 8 OHM	SPEAKER COMBI 8 OHM
0217.000		296088640102	4	SOCKELEINLAGE	ASE INSERT
0222.000		296382580101		ZIERLEISTE KPL ALU SILBER	ORNAMENTAL STRIP CPL ALU SILVER
WW.		759550276100		ZIERLEISTE KPL BLAU	ORNAMENTAL STRIP CPL BLUE
WW.		759550276200		ZIERLEISTE KPL HOLZ DUNKEL	ORNAMENTAL STRIP CPL WOOD DARK
WW.		759550276300		ZIERLEISTE KPL HELL GRUEN	ORNAMENTAL STRIP CPL LIGHT GREEN
WW.		759550276400		ZIERLEISTE KPL ORANGE	ORNAMENTAL STRIP CPL ORANGE
0300.000		296363980501		GEH-RUECKTEIL OFB	CABINET REAR PART SURFACE
0312.000		297006530101		ABDECKUNG FLASH	COVER FLASH
0314.000		297006513102		ABDECKUNG M.KOAX-KABEL	COVER W.COAX CABLE
0320.000		291102976405		TYPENAUFKLEBER VNA	TYPE LABEL VNA
0700.000	Δ	092461307601		ENTMAGNETISIERUNGSSPULE M.HALTER	DEGAUSSING COIL W.HOLDER
0750.000		812612528700	4	EINSATZBUCHSE BILDROHR	INSERT SOCKET PICT.TUBE
1100.000		830002041300		BILDR.A 59 EAK 652X44	PICT.TUBE A 59 EAK 652X44
1110.000	Δ	292013601106		ANODENKAPPE M.HOCHSPANNUNGSKABEL	ANODE CAP W.HIGH VOLTAGE CABLE
		295010855500		BEDIENEINHEIT M.AUFNAHME KEIN E-TEIL	CONTROL UNIT W.HOLDER CPL NO SPARE PART
1302.000		293033750201		DRAHTFEDER Klappe	SPRING FLAP
1304.000		295010851900		BEDIENPLATTE	CONTROL BOARD
1311.000		297033571100		TASTSCHALTER PROGRAMM +	KEY SWITCH PROGRAMME +
1312.000		297033571100		TASTSCHALTER PROGRAMM -	KEY SWITCH PROGRAMME -
1313.000		297033571100		TASTSCHALTER LAUTSTAERKE +	KEY SWITCH VOLUME +
1314.000		297033571100		TASTSCHALTER LAUTSTAERKE -	KEY SWITCH VOLUME -
1350.000		295017220502		TASTENSATZ PROGRAMM/LAUTSTAERKE	KEYS SET PROGRAMME/VOLUME
1352.000		295017360402		Klappe geklebt KPL	FLAP BONDED CPL
1353.000		270332210100		DRUCKSCHNAEPER	PRESSURE CATCH
1354.000		296380231101		DAEMPFBLOCK	DAMPING BLOCK
1360.000	Δ	297033910600		NETZSCHALTER O.WISCHER	POWER SWITCH W/O WIPER
1370.000		295017210503		TASTENKNOPF NETZ KPL	KEY KNOB POWER CPL
1383.000		293033904200		KOPFHUERERBUCHSE 3.5 O.SCHALTER	HEADPHONE SOCKET 3.5 W/O SWITCH
1384.000		293031688100		CINCH-BUCHSE 3-FACH FBAS/NF L,R	CINCH SOCKET 3 FOLD FBAS/AF L,R
1395.000		295017380108		AUFNAHME BEDIENPLATTE DRUCK KPL	HOLDER CONTROL BOARD PRINT CPL
1396.000		295015990102		ABDECKUNG S-BUCHSEN	COVER S-SOCKETS
1397.000	Δ	296382210104		ISOLIERFOLIE	INSULATING FOIL
2100.000	Δ	829099131600		NETZKABEL KPL	POWER CABLE CPL
2300.000		293051223100	X	BILDROHRPLATTE	PICT.TUBE BOARD
2400.000		296420660400		TP 150 C FERNBEDIENUNG	TP 150 C REMOTE CONTROL
		218529410900		BEDIENUNGSANLEITUNG D	OPERATING INSTRUCTIONS D
		218529411000		BEDIENUNGSANLEITUNG F/I	OPERATING INSTRUCTIONS F/I
		218529411100		BEDIENUNGSANLEITUNG GB/NL	OPERATING INSTRUCTIONS GB/NL
		218529411200		BEDIENUNGSANLEITUNG E/P	OPERATING INSTRUCTIONS E/P
		218529411300		BEDIENUNGSANLEITUNG DK/FIN	OPERATING INSTRUCTIONS DK/FIN
		218529411400		BEDIENUNGSANLEITUNG S/N	OPERATING INSTRUCTIONS S/N
		720100305000		SERVICE MANUAL D/GB	SERVICE MANUAL D/GB
		720100305100		SERVICE MANUAL D/GB 1.ERGAENZUNG	SERVICE MANUAL D/GB 1ST SUPPLEME
		296560044200		MONTAGEZUBEHOER F.BILDROHR KEIN E-TEIL	MOUNTING ACCESSORIES F.PICTURE NO SPARE PART

ÄNDERUNGEN VORBEHALTEN / SUBJECT TO ALTERATION

POS. NR. POS. NO.	ABB. FIG.	MATERIAL-NR. PART NUMBER	ANZ. QTY.	BEZEICHNUNG (D)	DESCRIPTION (GB)
		297040111400	X	CHASSIS-FS-STEREO CUC 1837 DIGI 100 KEIN E-TEIL	CHASSIS TV STEREO CUC 1837 DIGI 100 NO SPARE PART
				WW = WAHLWEISE X = SIEHE GESONDERTE E-LISTE	WW = OPTIONAL X = SEE SEPARATE PARTS LIST
				<b>HINWEIS:</b> DIE AKTUELLE SOFTWARE KOENNEN SIE IM INTERNET UNTER FOLGENDER ADRESSE ABRUFEN: WWW.GRUNDIG.DE MENU: SOFTWARE-DOWNLOAD	<b>NOTE:</b> YOU MAY DOWNLOAD THE CURRENT SOFTWARE IN THE INTERNET UNDER T FOLLOWING ADDRESS: WWW.GRUNDIG.D MENU: SOFTWARE-DOWNLOAD

POS. NR. POS. NO.	MATERIAL-NR. PART NUMBER	BEZEICHNUNG DESCRIPTION	POS. NR. POS. NO.	MATERIAL-NR. PART NUMBER	BEZEICHNUNG DESCRIPTION
	295010851900	BEDIENPLATTE CONTROL BOARD			
D 85001	830997837100	LE-DIODE LUB371GK			
IC 84001	830546123600	IC TSOP1236			

Es gelten die Vorschriften und Sicherheitshinweise gemäß dem Service Manual "Sicherheit", Mat.-Nummer 720108000000, sowie zusätzlich die eventuell abweichenden, landesspezifischen Vorschriften!



The regulations and safety instructions shall be valid as provided by the "Safety" Service Manual, part number 720108000000, as well as the respective national deviations.

ÄNDERUNGEN VORBEHALTEN / SUBJECT TO ALTERATION

Ersatzteilliste  
Spare Parts List

6 / 2002

## XENTIA 63 M 63-420/8 DOLBY

MATERIAL-NR. / PART NO.: 921852024000 BESTELL-NR. / ORDER NO.: GC18300 PROCON SILBER/PROCON SILVER  
VERSION NR./VERSION NO.: VNX

POS. NR. POS. NO.	ABB. FIG.	MATERIAL-NR. PART NUMBER	ANZ. QTY.	BEZEICHNUNG (D)	DESCRIPTION (GB)
		921852024000		XENTIA 63 M 63-420/8 DOLBY PROCON SILBER KEIN E-TEIL	XENTIA 63 M 63-420/8 DOLBY PROCON SILVER NO SPARE PART
0050.000				PROGRAMM FLASH-EPROM DOWNLOAD: WWW.GRUNDIG.DE/ PRODUKTE/KONTAKT/HAENDLERSERVICE	PROGRAM FLASH EPROM DOWNLOAD: WWW.GRUNDIG.DE/ PRODUCTS/CONTACT/RESELLER SUPPORT
0201.000 0320.000 0950.000 0950.000 1100.000 WW.		191260469701 2911029765905 2921040871100 292104087406 830002041300 830002041500	2	LAUTSPRECHER KOMBI 8 OHM TYPENAUFKLEBER VNX SHIFTSTECKER KPL 4 W/120 OHM SHIFTSTECKER KPL 4W/220 OHM BILDR.A59EAK652X44 BILDR.A59EAK252X44 PHILIPS	SPEAKER COMBI 8 OHM TYPE LABEL VNX SHIFT PLUG CPL 4 W/120 OHM SHIFT PLUG CPL 4W/220 OHM PICT.TUBE A59EAK652X44 PICT.TUBE A59EAK252X44 PHILIPS
1395.000		295017380109		AUFNAHME BEDIENPLATTE DRUCK KPL	HOLDER CONTROL BOARD PRINT CPL
2400.000 2410.000		296420660400 720086745100		TP 150 C FERNBEDIENUNG GRAU DECKEL BATTERIE TP 150 C	TP 150 C REMOTE CONTROL GREY BATTERY LID TP 150 C
		218529410900 218529411000 218529411100 218529411200 218529411300 218529411400 720100305000 720100305400 720100305500 720100305600		BEDIENUNGSANLEITUNG D BEDIENUNGSANLEITUNG F/I BEDIENUNGSANLEITUNG GB/NL BEDIENUNGSANLEITUNG E/P BEDIENUNGSANLEITUNG DK/FIN BEDIENUNGSANLEITUNG S/N SERVICE MANUAL D/GB SERVICE MANUAL D/GB 4.ERGAENZUNG SERVICE MANUAL D/GB 5.ERGAENZUNG SERVICE MANUAL D/GB 6.ERGAENZUNG	OPERATING INSTRUCTIONS D OPERATING INSTRUCTIONS F/I OPERATING INSTRUCTIONS GB/NL OPERATING INSTRUCTIONS E/P OPERATING INSTRUCTIONS DK/FIN OPERATING INSTRUCTIONS S/N SERVICE MANUAL D/GB SERVICE MANUAL D/GB 4TH SUPPLEMENT SERVICE MANUAL D/GB 5TH SUPPLEMENT SERVICE MANUAL D/GB 6TH SUPPLEMENT
		297040192900	X	CHASSIS-FS-STEREO CUC 1837 DIGI 100 KEIN E-TEIL  WW.=WAHLWEISE X=-SIEHE GESONDERTE E-LISTE  ALLE WEITEREN TEILE SIEHE E-LISTE XENTIA 63 M 63-420/8 DOLBY PROCON SILBER MAT.-NR.: 921852024000 BESTELL-NR.: GC18300 AUSGABE 9/2001 VERSION NR. VNA	CHASSIS TV STEREO CUC 1837 DIGI 100 NO SPARE PART  WW.=OPTIONAL X=-SEE SEPARATE PARTS LIST  FOR ALL OTHER PARTS SEE XENTIA 63 M 63-420/8 DOLBY PROCON SILVER PART NO.: 921852024000 ORDER NR.: GC18300 EDITION 9/2001 VERSION NO VNA

ÄNDERUNGEN VORBEHALTEN / SUBJECT TO ALTERATION

POS. NR. POS. NO.	MATERIAL-NR. PART NUMBER	BEZEICHNUNG DESCRIPTION	POS. NR. POS. NO.	MATERIAL-NR. PART NUMBER	BEZEICHNUNG DESCRIPTION
	295010851900	BEDIENPLATTE DIGI 100 CONTROL BOARD DIGI 100			
D 85001	830998411900	LE-DIODE L-119EGW			

Es gelten die Vorschriften und Sicherheitshinweise gemäß dem Service Manual "Sicherheit", Mat.-Nummer 720108000000, sowie zusätzlich die eventuell abweichenden, landesspezifischen Vorschriften!



The regulations and safety instructions shall be valid as provided by the "Safety" Service Manual, part number 720108000000, as well as the respective national deviations.

ÄNDERUNGEN VORBEHALTEN / SUBJECT TO ALTERATION

MATERIAL-NR. / PART NO.: 921852027700      BESTELL-NR. / ORDER NO.: GC18377      ELON METALLIC  
VERSION NR./VERSION NO.: VNA

POS. NR. POS. NO.	ABB. FIG.	MATERIAL-NR. PART NUMBER	ANZ. QTY.	BEZEICHNUNG <b>(D)</b>	DESCRIPTION <b>(GB)</b>
		921852027700		XENTIA 63 M 63-420/8 DOLBY ELON METALLIC KEIN E-TEIL	XENTIA 63 M 63-420/8 DOLBY ELON METALLIC NO SPARE PART
0050.000				PROGRAMM FLASH-EPROM DOWNLOAD: WWW.GRUNDIG.DE/ PRODUKTE/KONTAKT/HAENDLERSERVICE	PROGRAM FLASH EPROM DOWNLOAD: WWW.GRUNDIG.DE/ PRODUCTS/CONTACT/RESELLER SUPPORT
0201.000 0320.000 0950.000 0950.000		191260469701 291102976405 292104087100 292104087406	2	LAUTSPRECHER KOMBI 8 OHM TYPENAUFKLEBER VNA SHIFTSTECKER KPL 4 W/120 OHM SHIFTSTECKER KPL 4W/220 OHM	SPEAKER COMBI 8 OHM TYPE LABEL VNA SHIFT PLUG CPL 4 W/120 OHM SHIFT PLUG CPL 4W/220 OHM
1360.000 1370.000 1395.000	△	297033910600 295017210202 295017380108		NETZSCHALTER O. WISCHER TASTENKNOPF NETZ KPL AUFNAHME BEDINPLATTE DRUCK KPL	POWER SWITCH W/O WIPER KEY POWER CPL HOLDER CONTOL BOARD PRINT CPL
2400.000 2410.000		296420660400 720086745100		TP 150 C FERNBEDIENUNG GRAU DECKEL BATTERIE TP 150 C	TP 150 C REMOTE CONTROL GREY BATTERY LID TP 150 C
		218529410900 218529411000 218529411100 218529411200 218529411300 218529411400 720100305000 720100305400 720100305500 720100305600		BEDIENUNGSANLEITUNG D BEDIENUNGSANLEITUNG F/I BEDIENUNGSANLEITUNG GB/NL BEDIENUNGSANLEITUNG E/P BEDIENUNGSANLEITUNG DK/FIN BEDIENUNGSANLEITUNG S/N SERVICE MANUAL D/GB SERVICE MANUAL D/GB 4. ERGAENZUNG SERVICE MANUAL D/GB 5. ERGAENZUNG SERVICE MANUAL D/GB 6. ERGAENZUNG	OPERATING INSTRUCTIONS D OPERATING INSTRUCTIONS F/I OPERATING INSTRUCTIONS GB/NL OPERATING INSTRUCTIONS E/P OPERATING INSTRUCTIONS DK/FIN OPERATING INSTRUCTIONS S/N SERVICE MANUAL D/GB SERVICE MANUAL D/GB 4TH SUPPLEMENT SERVICE MANUAL D/GB 5TH SUPPLEMENT SERVICE MANUAL D/GB 6TH SUPPLEMENT
				ALLE WEITEREN TEILE SIEHE E-LISTE XENTIA 63 M 63-420/8 DOLBY ELON METALLIC MAT.-NR.: 921852027700 BESTELL-NR.: GC18377 AUSGABE 2/2001 VERSION NR.: VNM	FOR ALL OTHER PARTS SEE XENTIA 63 M 63-420/8 DOLBY ELON METALLIC PART NO: 921852027700 ORDER NR: GC18377 EDITION 2/2001 VERSION NO.: VNM

POS. NR. MATERIAL-NR. BEZEICHNUNG  
POS. NO. PART NUMBER DESCRIPTION

POS. NR. MATERIAL-NR. BEZEICHNUNG  
POS. NO. PART NUMBER DESCRIPTION

## XENTIA 63 M 63-420/8 DOLBY

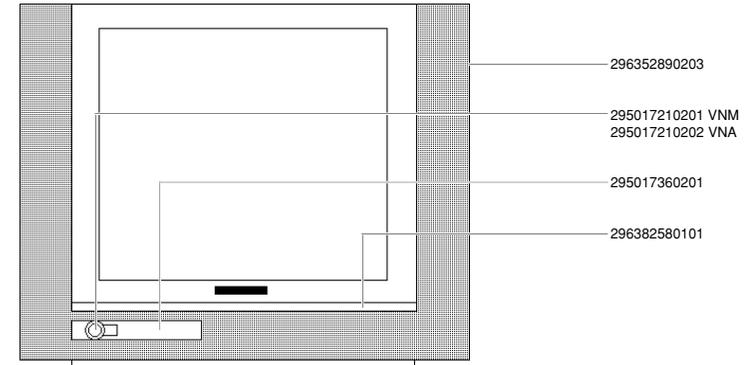

Es gelten die Vorschriften und Sicherheitshinweise gemäß dem Service Manual "Sicherheit", Mat.-Nummer 720108000000, sowie zusätzlich die eventuell abweichenden, landesspezifischen Vorschriften!



The regulations and safety instructions shall be valid as provided by the "Safety" Service Manual, part number 720108000000, as well as the respective national deviations.

### Ersatzteilliste Spare Parts List

### 6 / 2002

### XENTIA 63 M 63-420/8 DOLBY

MATERIAL-NR. / PART NO.: 921852027700      BESTELL-NR. / ORDER NO.: GC18377    ELON METALLIC  
VERSION NR./VERSION NO.: **VNX**

POS. NR. POS. NO.	ABB. FIG.	MATERIAL-NR. PART NUMBER	ANZ. QTY.	BEZEICHNUNG (D)	DESCRIPTION (GB)
		921852027700		XENTIA 63 M 63-420/8 DOLBY ELON METALLIC KEIN E-TEIL	XENTIA 63 M 63-420/8 DOLBY ELON METALLIC NO SPARE PART
0050.000				PROGRAMM FLASH-EPROM DOWNLOAD: WWW.GRUNDIG.DE/ PRODUKTE/KONTAKT/HAENDLERSERVICE	PROGRAM FLASH EPROM DOWNLOAD: WWW.GRUNDIG.DE/ PRODUCTS/CONTACT/RESELLER SUPPORT
0201.000 0320.000 0950.000 0950.000 1100.000 WW.		191260469701 291102976505 292104087100 292104087406 830002041300 830002041500	2	LAUTSPRECHER KOMBI 8 OHM TYPENAUFKLEBER VNX SHIFTSTECKER KPL 4 W/120 OHM SHIFTSTECKER KPL 4W/220 OHM BILDR.A59EAK652X44 BILDR.A59EAK252X44 PHILIPS	SPEAKER COMBI 8 OHM TYPE LABEL VNX SHIFT PLUG CPL 4 W/120 OHM SHIFT PLUG CPL 4W/220 OHM PICT.TUBE A59EAK652X44 PICT.TUBE A59EAK252X44 PHILIPS
1360.000 1370.000 1395.000	△	297033910600 295017210202 295017380109		NETZSCHALTER O.WISCHER TASTENKNOPF NETZ KPL AUFNAHME BEDINPLATTE DRUCK KPL	POWER SWITCH W/O WIPER KEY POWER CPL HOLDER CONTOL BOARD PRINT CPL
2400.000 2410.000		296420660400 720086745100		TP 150 C FERNBEDIENUNG GRAU DECKEL BATTERIE TP 150 C	TP 150 C REMOTE CONTROL GREY BATTERY LID TP 150 C
		218529410900 218529411000 218529411100 218529411200 218529411300 218529411400 720100305000 720100305400 720100305500 720100305600		BEDIENUNGSANLEITUNG D BEDIENUNGSANLEITUNG F/I BEDIENUNGSANLEITUNG GB/NL BEDIENUNGSANLEITUNG E/P BEDIENUNGSANLEITUNG DK/FIN BEDIENUNGSANLEITUNG S/N SERVICE MANUAL D/GB SERVICE MANUAL D/GB 4.ERGAENZUNG SERVICE MANUAL D/GB 5.ERGAENZUNG SERVICE MANUAL D/GB 6.ERGAENZUNG	OPERATING INSTRUCTIONS D OPERATING INSTRUCTIONS F/I OPERATING INSTRUCTIONS GB/NL OPERATING INSTRUCTIONS E/P OPERATING INSTRUCTIONS DK/FIN OPERATING INSTRUCTIONS S/N SERVICE MANUAL D/GB SERVICE MANUAL D/GB 4TH SUPPLEMENT SERVICE MANUAL D/GB 5TH SUPPLEMENT SERVICE MANUAL D/GB 6TH SUPPLEMENT
		297040192900	X	CHASSIS-FS-STEREO CUC 1837 DIGI 100 KEIN E-TEIL  WW.-WAHLWEISE X=SIEHE GESONDERTE E-LISTE  ALLE WEITEREN TEILE SIEHE E-LISTE XENTIA 63 M 63-420/8 DOLBY ELON METALLIC MAT.-NR.: 921852027700 BESTELL-NR.: GC18377 AUSGABE 2/2001 VERSION NR.: <b>VNM</b>	CHASSIS TV STEREO CUC 1837 DIGI 100 NO SPARE PART  WW.-OPTIONAL X=SEE SEPARATE PARTS LIST  FOR ALL OTHER PARTS SEE XENTIA 63 M 63-420/8 DOLBY ELON METALLIC PART NO: 921852027700 ORDER NR: GC18377 EDITION 2/2001 VERSION NO.: <b>VNM</b>

POS. NR. POS. NO.	MATERIAL-NR. PART NUMBER	BEZEICHNUNG DESCRIPTION
	295010851900	BEDIENPLATTE DIGI 100 CONTROL BOARD DIGI 100
D 85001	830998411900	LE-DIODE L-119EGW

POS. NR. POS. NO.	MATERIAL-NR. PART NUMBER	BEZEICHNUNG DESCRIPTION
	296352890203	
	295017210201	VNM
	295017210202	VNA/VNX
	295017360201	
	296382580101	

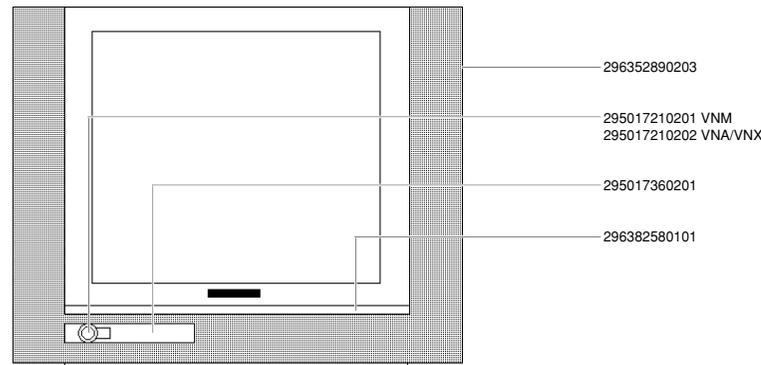

ÄNDERUNGEN VORBEHALTEN / SUBJECT TO ALTERATION

Es gelten die Vorschriften und Sicherheitshinweise gemäß dem Service Manual "Sicherheit", Mat.-Nummer 720108000000, sowie zusätzlich die eventuell abweichenden, landesspezifischen Vorschriften!



The regulations and safety instructions shall be valid as provided by the "Safety" Service Manual, part number 720108000000, as well as the respective national deviations.

ÄNDERUNGEN VORBEHALTEN / SUBJECT TO ALTERATION

### Ersatzteilliste Spare Parts List

6 / 2002

### WIEN SE 6340 DOLBY

MATERIAL-NR. / PART NO.: 922207016900 BESTELL-NR. / ORDER NO.: GCM5500 TESSA-BLACK/TESSA BLACK  
VERSION NR./VERSION NO.: VNA

POS. NR. POS. NO.	ABB. FIG.	MATERIAL-NR. PART NUMBER	ANZ. QTY.	BEZEICHNUNG <b>(D)</b>	DESCRIPTION <b>(GB)</b>
		922207016900		WIEN SE 6340 DOLBY TESSA-BLACK KEIN E-TEIL	WIEN SE 6340 DOLBY TESSA BLACK NO SPARE PART
0050.000				PROGRAMM FLASH-EPROM DOWNLOAD: WWW.GRUNDIG.DE/PRODUKTE/ KONTAKT/HAENDLERSERVICE	PROGRAM FLASH-EPROM DOWNLOAD: WWW.GRUNDIG.DE/PRODUCTS/ CONTACT/RESELLER SUPPORT
0200.000 0201.000 0229.000 0252.000 0320.000 0450.000 0450.000 0700.000 0950.000 0950.000 1100.000 1370.000 2410.000		296355230601 191260469701 296365760102 295017380203 291104086403 297006544101 296361810100 <b>Δ</b> 092461287510 292104087100 292104087406 830002041500 295017210302 720086734000	2	GEH-VORDETEIL DRUCK KPL LAUTSPRECHER KOMBI 8 OHM IR-FENSTER AUFNAHME DRUCK KPL TYPENAUFKLEBER VNA HALTER LEITERPLATTE HALTER ENTMAGNETISIERUNGSSPULE SHIFTSTECKER KPL 4W/120 OHM SHIFTSTECKER KPL 4W/220 OHM BILDROHR A 59 EAK252X44 PHILIPS TASTENKNOPF NETZSCHALTER KPL DECKEL BATTERIE	CABINET FRONT PART PRINT LOUDSPEAKER COMBI 8 OHM IR WINDOW HOLDER PRINT CPL TYPE LABEL SELF ADHESIVE VNA HOLDER PCB HOLDER COIL DEGAUSSING SHIFT PLUG CPL 4W/120 OHM SHIFT PLUG CPL 4W/220 OHM PICTURE TUBE A 59 EAK252X44 PHILIPS KEY KNOB MAINS SWITCH CPL BATTERY LID
		222079410100 720100305000 720100305100 720100305400 720100305500 720100305600		BEDIENUNGSANLEITUNG D/I SERVICE MANUAL D/GB SERVICE MANUAL D/GB 1.ERGAENZUNG SERVICE MANUAL D/GB 4.ERGAENZUNG SERVICE MANUAL D/GB 5.ERGAENZUNG SERVICE MANUAL D/GB 6.ERGAENZUNG	OPERATION INSTRUCTIONS D/I SERVICE MANUAL D/GB SERVICE MANUAL D/GB 1ST SUPPLEMENT SERVICE MANUAL D/GB 4TH SUPPLEMENT SERVICE MANUAL D/GB 5TH SUPPLEMENT SERVICE MANUAL D/GB 6TH SUPPLEMENT
		297040194500	X	CHASSIS-FS-STEREO DIGI 100 CUC 1837 KEIN E-TEIL	CHASSIS TV STEREO DIGI 100 CUC 1837 NO SPARE PART
				X = SIEHE GESONDERTE E-LISTE	X = SEE SEPARATE PARTS LIST
				ALLE ANDEREN TEILE SIEHE E-LISTE WIEN SE 6340 DOLBY MAT.-NR.: 922207016900 BESTELL-NR.: G.CM 5500 AUSGABE 2/2001 VERSION-NR.: VNM	FOR ALL OTHER PARTS SEE WIEN SE 6340 DOLBY PART NO.: 922207016900 ORDER NO.: G. CM 5500 EDITION 2/2001 VERSION NO.: VNM

POS. NR. POS. NO.	MATERIAL-NR. PART NUMBER	BEZEICHNUNG DESCRIPTION
D 85001	830998411900LE-DIODE L-119EGW	

POS. NR. POS. NO.	MATERIAL-NR. PART NUMBER	BEZEICHNUNG DESCRIPTION

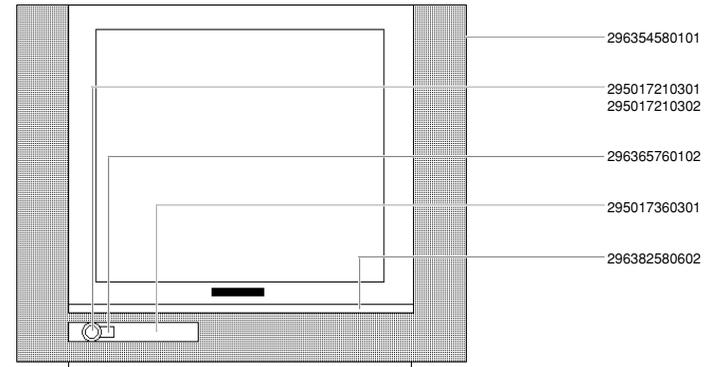

20

ÄNDERUNGEN VORBEHALTEN / SUBJECT TO ALTERATION

Es gelten die Vorschriften und Sicherheitshinweise gemäß dem Service Manual "Sicherheit", Mat.-Nummer 720108000000, sowie zusätzlich die eventuell abweichenden, landesspezifischen Vorschriften!



The regulations and safety instructions shall be valid as provided by the "Safety" Service Manual, part number 720108000000, as well as the respective national deviations.

ÄNDERUNGEN VORBEHALTEN / SUBJECT TO ALTERATION

### Ersatzteilliste Spare Parts List

### 6 / 2002

### ST 70-265/8 DOLBY

MATERIAL-NR. / PART NO.: 921989027500    BESTELL-NR. / ORDER NO.: GCM5400    SCHWARZ/BLACK  
VERSION NR./VERSION NO.: VNA

POS. NR. POS. NO.	ABB. FIG.	MATERIAL-NR. PART NUMBER	ANZ. QTY.	BEZEICHNUNG <b>(D)</b>	DESCRIPTION <b>(GB)</b>
		921989027500		ST 70-265/8 DOLBY SCHWARZ KEIN E-TEIL	ST 70-265/8 DOLBY BLACK NO SPARE PART
0050.000				PROGRAMM FLASH-EPROM DOWNLOAD: WWW.GRUNDIG.DE/PRODUKTE/ KONTAKT/HAENDLERSERVICE	PROGRAM FLASH-EPROM DOWNLOAD: WWW.GRUNDIG.DE/PRODUCTS/ CONTACT/RESELLER SUPPORT
0229.000		296321140102		EMBLEM GRUNDIG	EMBLEM GRUNDIG
0320.000		291104256404		TYPENAUFKLEBER VNA	TYPE LABEL SELF ADHESIVE VNA
0450.000		297006544101		HALTER LEITERPLATTE	HOLDER PCB
0700.000	△	092461317506		ENTMAGNETISIERUNGSSPULE	DEGAUSSING COIL
0950.000		292104087100		SHIFTSTECKER KPL 4W/120 OHM	SHIFT PLUG CPL 4W/120 OHM
0950.000		292104087406		SHIFTSTECKER KPL 4W/220 OHM	SHIFT PLUG CPL 4W/220 OHM
2400.000		296420660300		TP 150 C FERNBEDIENUNG	TP 150 C REMOTE CONTROL
2410.000		720086745000		DECKEL BATTERIE	BATTERY LID TP
		219899410900		BEDIENUNGSANLEITUNG D	OPERATING INSTRUCTIONS D
		219899411000		BEDIENUNGSANLEITUNG F/I	OPERATING INSTRUCTIONS F/I
		219899411100		BEDIENUNGSANLEITUNG GB/NL	OPERATING INSTRUCTIONS GB/NL
		219899411200		BEDIENUNGSANLEITUNG E/P	OPERATING INSTRUCTIONS E/P
		219899411300		BEDIENUNGSANLEITUNG DK/FIN	OPERATING INSTRUCTIONS DK/FIN
		219899411400		BEDIENUNGSANLEITUNG S/N	OPERATING INSTRUCTIONS S/N
		720100305000		SERVICE MANUAL D/GB	SERVICE MANUAL D/GB
		720100305000		SERVICE MANUAL D/GB	SERVICE MANUAL D/GB
		720100305200		SERVICE MANUAL D/GB 2.ERGAENZUNG	SERVICE MANUAL D/GB 2ND SUPPLEMENT
		720100305400		SERVICE MANUAL D/GB 4.ERGAENZUNG	SERVICE MANUAL D/GB 4TH SUPPLEMENT
		720100305500		SERVICE MANUAL D/GB 5.ERGAENZUNG	SERVICE MANUAL D/GB 5TH SUPPLEMENT
		720100305600		SERVICE MANUAL D/GB 6.ERGAENZUNG	SERVICE MANUAL D/GB 6TH SUPPLEMENT
				ALLE ANDEREN TEILE SIEHE E-LISTE ST 70-265/8 DOLBY MAT.-NR: 921989027500 BESTELL-NR: GCM5400 AUSGABE 3/2001 VERSION-NR.: VNM	FOR ALL OTHER PARTS SEE ST 70-265/8 DOLBY PART NO: 921989027500 ORDER NO: GCM5400 EDITION 3/2001 VERSION NO.: VNM

POS. NR. POS. NO.	MATERIAL-NR. PART NUMBER	BEZEICHNUNG DESCRIPTION	POS. NR. POS. NO.	MATERIAL-NR. PART NUMBER	BEZEICHNUNG DESCRIPTION
	295010852900	BEDIENPLATTE CONTROL BOARD			
IC 01863	830521006400	IC MC33164P-5RP			
IC 84001	830546123600	IC TSOP1236			
IC 84001	830546123600	IC TSOP1236			
R 01861	870000754500	KSW 0207 1 MOHM 5%			
T 01872	830320755700	TRANS BC557C			
T 01873	830320287500	TRANS 2SD1866TV2			
T 01877	830329387600	TRANS BC876			

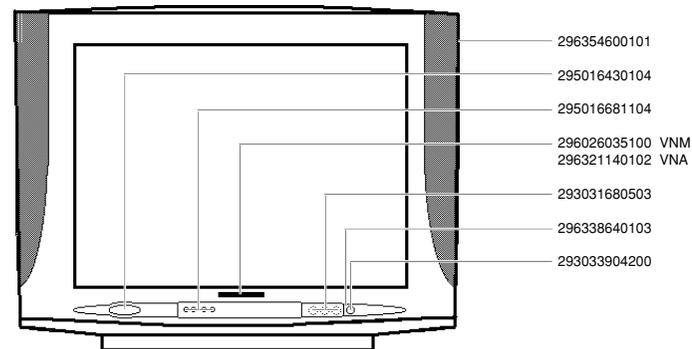

Es gelten die Vorschriften und Sicherheitshinweise gemäß dem Service Manual "Sicherheit", Mat.-Nummer 720108000000, sowie zusätzlich die eventuell abweichenden, landesspezifischen Vorschriften!



The regulations and safety instructions shall be valid as provided by the "Safety" Service Manual, part number 720108000000, as well as the respective national deviations.

## Ersatzteilliste Spare Parts List

6 / 2002

**ST 70-265/8 DOLBY**

MATERIAL-NR. / PART NO.: 921989027500    BESTELL-NR. / ORDER NO.: GCM5400    SCHWARZ/BLACK  
VERSION NR./VERSION NO.: VNX

POS. NR. POS. NO.	ABB. FIG.	MATERIAL-NR. PART NUMBER	ANZ. QTY.	BEZEICHNUNG (D)	DESCRIPTION (GB)
		921989027500		ST 70-265/8 DOLBY SCHWARZ KEIN E-TEIL	ST 70-265/8 DOLBY BLACK NO SPARE PART
0050.000				PROGRAMM FLASH-EPROM DOWNLOAD: WWW.GRUNDIG.DE/PRODUKTE/ KONTAKT/HAENDLERSERVICE	PROGRAM FLASH-EPROM DOWNLOAD: WWW.GRUNDIG.DE/PRODUCTS/ CONTACT/RESELLER SUPPORT
0229.000		296321140102		EMBLEM GRUNDIG	EMBLEM GRUNDIG
0320.000		291104256504		TYPENAUFKLEBER VNX	TYPE LABEL SELF ADHESIVE VNX
0700.000	△	092461317507		ENTMAGNETISIERUNGSSPULE	DEGAUSSING COIL
0950.000		292104087100		SHIFTSTECKER KPL 4W/120 OHM	SHIFT PLUG CPL 4W/120 OHM
0950.000		292104087406		SHIFTSTECKER KPL 4W/220 OHM	SHIFT PLUG CPL 4W/220 OHM
2400.000		296420660300		TP 150 C FERNBEDIENUNG	TP 150 C REMOTE CONTROL
2410.000		720086745000		DECKEL BATTERIE	BATTERY LID
		219899410900		BEDIENUNGSANLEITUNG D	OPERATION INSTRUCTIONS D
		219899411000		BEDIENUNGSANLEITUNG F/I	OPERATION INSTRUCTIONS F/I
		219899411100		BEDIENUNGSANLEITUNG GB/NL	OPERATION INSTRUCTIONS GB/NL
		219899411200		BEDIENUNGSANLEITUNG E/P	OPERATION INSTRUCTIONS E/P
		219899411300		BEDIENUNGSANLEITUNG DK/FIN	OPERATION INSTRUCTIONS DK/FIN
		219899411400		BEDIENUNGSANLEITUNG S/N	OPERATION INSTRUCTIONS S/N
		720100305000		SERVICE MANUAL D/GB	SERVICE MANUAL D/GB
		720100305400		SERVICE MANUAL D/GB 4.ERG	SERVICE MANUAL D/GB 4TH SUPPLEMENT
		720100305500		SERVICE MANUAL D/GB 5.ERG	SERVICE MANUAL D/GB 5TH SUPPLEMENT
		720100305600		SERVICE MANUAL D/GB 6.ERG	SERVICE MANUAL D/GB 6TH SUPPLEMENT
		297040192600	X	CHASSIS-FS-STEREO DIGI 100 CUC 1837 KEIN E-TEIL	CHASSIS TV STEREO DIGI 100 CUC 1837 NO SPARE PART
				X = SIEHE GESONDERTE E-LISTE	X = SEE SEPARATE PARTS LIST
				ALLE ANDEREN TEILE SIEHE E-LISTE ST 70-265/8 DOLBY MAT.-NR: 921989027500 BESTELL-NR: GCM5400 AUSGABE 3/2001 VERSION-NR.: VNM	FOR ALL OTHER PARTS SEE ST 70-265/8 DOLBY PART NO: 921989027500 ORDER NO: GCM5400 EDITION 3/2001 VERSION NO.: VNM

**ST 70-265/8 DOLBY**

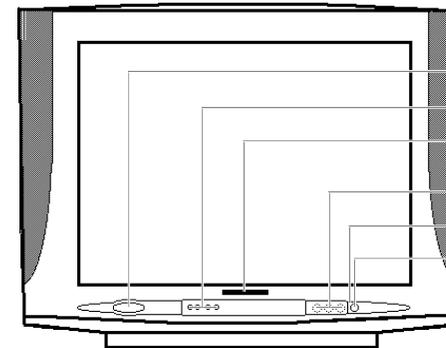

296354600101  
295016430104  
295016681104  
296026035100 VNM  
296321140102 VNA/VNX  
293031680503  
296338640103  
293033904200

Es gelten die Vorschriften und Sicherheitshinweise gemäß dem Service Manual "Sicherheit", Mat.-Nummer 720108000000, sowie zusätzlich die eventuell abweichenden, landesspezifischen Vorschriften!



The regulations and safety instructions shall be valid as provided by the "Safety" Service Manual, part number 720108000000, as well as the respective national deviations.

MATERIAL-NR. / PART NO.: 921921017500 BESTELL-NR. / ORDER NO.: GCK6500 SCHWARZ/BLACK  
VERSION NR./VERSION NO.: VNX

POS. NR. POS. NO.	ABB. FIG.	MATERIAL-NR. PART NUMBER	ANZ. QTY.	BEZEICHNUNG Ⓓ	DESCRIPTION ⒼⒷ
		921921017500		SEDANCE 70 ST 70-284 DOLBY SCHWARZ KEIN E-TEIL	SEDANCE 70 ST 70-284 DOLBY BLACK NO SPARE PART
0050.000				PROGRAMM FLASH-EPROM DOWNLOAD: WWW.GRUNDIG.DE/ PRODUKTE/KONTAKT/HAENDLERSERVICE	PROGRAM FLASH EPROM DOWNLOAD: WWW.GRUNDIG.DE/ PRODUCTS/CONTACT/RESELLER SUPPORT
0218.000		295017590104		RAHMEN M.TASTENKNOPF NETZ KPL	FRAME W.KEY POWER CPL
0320.000		291103816501		TYPENAUFKLEBER VNX	TYPE LABEL VNX
0700.000	△	092461317506		ENTMAGNETISIERUNGSSPULE M.HALTER	DEGAUSSING COIL W.HOLDER
0950.000		292104087100		SHIFTSTECKER KPL 4 W/120 OHM	SHIFT PLUG CPL 4 W/120 OHM
0950.000		292104087406		SHIFTSTECKER KPL 4W/220 OHM	SHIFT PLUG CPL 4W/220 OHM
2400.000		296420660300		TP 150 C FERNBEDIENUNG SCHWARZ	TP 150 C REMOTE CONTROL BLACK
2410.000		720086745000		DECKEL BATTERIE TP 150 C	BATTERY LID TP 150 C
		219219413100		BEDIENUNGSANLEITUNG D	OPERATING INSTRUCTIONS D
		219219413200		BEDIENUNGSANLEITUNG F/I	OPERATING INSTRUCTIONS F/I
		219219413300		BEDIENUNGSANLEITUNG GB/NL	OPERATING INSTRUCTIONS GB/NL
		720100305000		SERVICE MANUAL D/GB	SERVICE MANUAL D/GB
		720100305400		SERVICE MANUAL D/GB 4.ERGAENZUNG	SERVICE MANUAL D/GB 4TH SUPPLEMENT
		720100305500		SERVICE MANUAL D/GB 5.ERGAENZUNG	SERVICE MANUAL D/GB 5TH SUPPLEMENT
		720100305600		SERVICE MANUAL D/GB 6.ERGAENZUNG	SERVICE MANUAL D/GB 6TH SUPPLEMENT
				ALLE WEITEREN TEILE SIEHE E-LISTE SEDANCE 70 ST 70-284 DOLBY SCHWARZ MAT.-NR.: 921921017500 BESTELL-NR.: GCK6500 AUSGABE 11/2000 VERSION NR.: VNM	FOR ALL OTHER PARTS SEE SEDANCE 70 ST 70-284 DOLBY BLACK PART NO.: 921921017500 ORDER NR.: GCK6500 EDITION 11/2000 VERSION NO.: VNM

ÄNDERUNGEN VORBEHALTEN / SUBJECT TO ALTERATION

POS. NR. MATERIAL-NR. BEZEICHNUNG  
POS. NO. PART NUMBER DESCRIPTION

POS. NR. MATERIAL-NR. BEZEICHNUNG  
POS. NO. PART NUMBER DESCRIPTION

### SEDANCE 70 ST 70-284 DOLBY

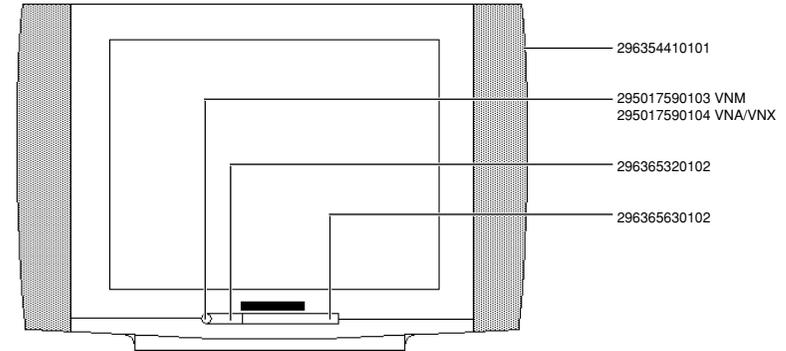

Es gelten die Vorschriften und Sicherheitshinweise gemäß dem Service Manual "Sicherheit", Mat.-Nummer 720108000000, sowie zusätzlich die eventuell abweichenden, landesspezifischen Vorschriften!



The regulations and safety instructions shall be valid as provided by the "Safety" Service Manual, part number 720108000000, as well as the respective national deviations.

ÄNDERUNGEN VORBEHALTEN / SUBJECT TO ALTERATION

MATERIAL-NR. / PART NO.: 921921017500 BESTELL-NR. / ORDER NO.: GCK6500 SCHWARZ/BLACK  
VERSION NR./VERSION NO.: **VNR**

POS. NR. POS. NO.	ABB. FIG.	MATERIAL-NR. PART NUMBER	ANZ. QTY.	BEZEICHNUNG ①	DESCRIPTION ②
		921921017500		SEDANCE 70 ST 70-284 DOLBY SCHWARZ KEIN E-TEIL	SEDANCE 70 ST 70-284 DOLBY BLACK NO SPARE PART
0050.000				PROGRAMM FLASH-EPROM DOWNLOAD: WWW.GRUNDIG.DE/ PRODUKTE/KONTAKT/HAENDLERSERVICE	PROGRAM FLASH EPROM DOWNLOAD: WWW.GRUNDIG.DE/ PRODUCTS/CONTACT/RESELLER SUPPORT
0218.000 0300.000 0320.000 0700.000 0950.000 0950.000		295017590105 296319810901 291103816701 092461317507 292104087100 292104087406		RAHMEN M.TASTENKNOPF NETZ KPL GEH-RUECKTEIL OFB TYPENAUFKLEBER VNR ENTMAGNETISIERUNGSSPULE M.HALTER SHIFTSTECKER KPL 4 W/120 OHM SHIFTSTECKER KPL 4W/220 OHM	FRAME W.KEY POWER CPL CABINET REAR PART SURFACE TREATED TYPE LABEL VNR DEGAUSSING COIL W.HOLDER SHIFT PLUG CPL 4 W/120 OHM SHIFT PLUG CPL 4W/220 OHM
2400.000 2410.000		296420660300 720086745000		TP 150 C FERNBEDIENUNG SCHWARZ DECKEL BATTERIE TP 150 C	TP 150 C REMOTE CONTROL BLACK BATTERY LID TP 150 C
		219219413100 219219413200 219219413300 720100305000 720100305400 720100305500 720100305600		BEDIENUNGSANLEITUNG D BEDIENUNGSANLEITUNG F/I BEDIENUNGSANLEITUNG GB/NL SERVICE MANUAL D/GB SERVICE MANUAL D/GB 4.ERGAENZUNG SERVICE MANUAL D/GB 5.ERGAENZUNG SERVICE MANUAL D/GB 6.ERGAENZUNG	OPERATING INSTRUCTIONS D OPERATING INSTRUCTIONS F/I OPERATING INSTRUCTIONS GB/NL SERVICE MANUAL D/GB SERVICE MANUAL D/GB 4TH SUPPLEMENT SERVICE MANUAL D/GB 5TH SUPPLEMENT SERVICE MANUAL D/GB 6TH SUPPLEMENT
		297040190800	X	CHASSIS-FS-STEREO CUC 1837 DIDGI 100 KEIN E-TEIL  X=SIEHGE GESONDERTE E-LISTE  ALLE WEITEREN TEILE SIEHE E-LISTE SEDANCE 70 ST 70-284 DOLBY SCHWARZ MAT.-NR.: 921921017500 BESTELL-NR.: GCK6500 AUSGABE 11/2000 VERSION NR.: <b>VNM</b>	CHASSIS TV STEREO CUC 1837 DIDGI 100 NO SPARE PART  X=SEE SEPARATE PARTS LIST  FOR ALL OTHER PARTS SEE SEDANCE 70 ST 70-284 DOLBY BLACK PART NO: 921921017500 ORDER NR: GCK6500 EDITION 11/2000 VERSION NO.: <b>VNM</b>

ÄNDERUNGEN VORBEHALTEN / SUBJECT TO ALTERATION

POS. NR. MATERIAL-NR. BEZEICHNUNG  
POS. NO. PART NUMBER DESCRIPTION

POS. NR. MATERIAL-NR. BEZEICHNUNG  
POS. NO. PART NUMBER DESCRIPTION

### SEDANCE 70 ST 70-284 DOLBY

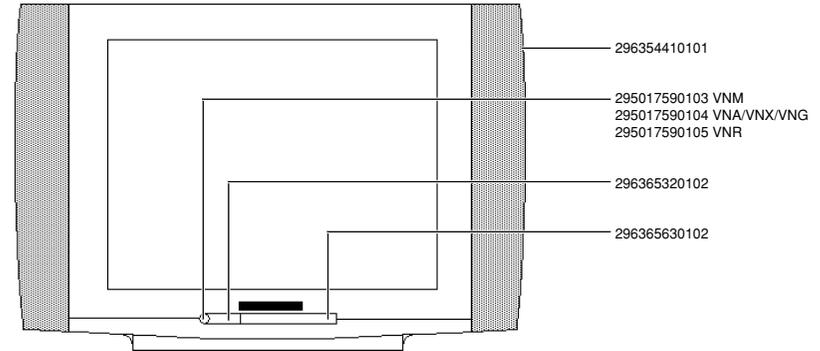

Es gelten die Vorschriften und Sicherheitshinweise gemäß dem Service Manual "Sicherheit", Mat.-Nummer 720108000000, sowie zusätzlich die eventuell abweichenden, landesspezifischen Vorschriften!



The regulations and safety instructions shall be valid as provided by the "Safety" Service Manual, part number 720108000000, as well as the respective national deviations.

ÄNDERUNGEN VORBEHALTEN / SUBJECT TO ALTERATION

## Ersatzteilliste Spare Parts List

6 / 2002

## SEDANCE 70 ST 70-284 DOLBY

MATERIAL-NR. / PART NO.: 921921017500    BESTELL-NR. / ORDER NO.: GCK6500    SCHWARZ/BLACK  
VERSION NR./VERSION NO.: VNU

POS. NR. POS. NO.	ABB. FIG.	MATERIAL-NR. PART NUMBER	ANZ. QTY.	BEZEICHNUNG (D)	DESCRIPTION (GB)
		921921017500		SEDANCE 70 ST 70-284 DOLBY SCHWARZ KEIN E-TEIL	SEDANCE 70 ST 70-284 DOLBY BLACK NO SPARE PART
0050.000				PROGRAMM FLASH-EPROM DOWNLOAD: WWW.GRUNDIG.DE/ PRODUKTE/KONTAKT/HAENDLERSERVICE	PROGRAM FLASH EPROM DOWNLOAD: WWW.GRUNDIG.DE/ PRODUCTS/CONTACT/RESELLER SUPPORT
0218.000		295017590105		RAHMEN M.TASTENKNOPF NETZ KPL	FRAME W.KEY POWER CPL
0300.000		296319810901		GEH-RUECKTEIL OFB	CABINET REAR PART SURFACE TREATED
0320.000		291104616801		TYPENAUFKLEBER VNU	TYPE LABEL VNU
0700.000	△	092461317507		ENTMAGNETISIERUNGSSPULE M.HALTER	DEGAUSSING COIL W.HOLDER
0950.000		292104087100		SHIFTSTECKER KPL 4 W/120 OHM	SHIFT PLUG CPL 4 W/120 OHM
0950.000		292104087406		SHIFTSTECKER KPL 4W/220 OHM	SHIFT PLUG CPL 4W/220 OHM
1100.000		830003047400		BILDR.A66EAK554X44	PICT.TUBE A66EAK554X44
1110.000	△	292013601106		ANODENKAPPE M.HOCHSPANNUNGSKABEL	ANODE CAP W.HIGH VOLTAGE CABLE
2400.000		296420660300		TP 150 C FERNBEDIENUNG SCHWARZ	TP 150 C REMOTE CONTROL BLACK
2410.000		720086745000		DECKEL BATTERIE TP 150 C	BATTERY LID TP 150 C
		219219413500		BEDIENUNGSANLEITUNG D	OPERATING INSTRUCTIONS D
		219219413600		BEDIENUNGSANLEITUNG F/I	OPERATING INSTRUCTIONS F/I
		219219413700		BEDIENUNGSANLEITUNG GB/NL	OPERATING INSTRUCTIONS GB/NL
		720100305400		SERVICE MANUAL D/GB 4.ERGAENZUNG	SERVICE MANUAL D/GB 4TH SUPPLEMENT
		720100305500		SERVICE MANUAL D/GB 5.ERGAENZUNG	SERVICE MANUAL D/GB 5TH SUPPLEMENT
		720100305600		SERVICE MANUAL D/GB 6.ERGAENZUNG	SERVICE MANUAL D/GB 6TH SUPPLEMENT
		297040194800	X	CHASSIS-FS-STEREO CUC 1837 DIDGI 100 KEIN E-TEIL	CHASSIS TV STEREO CUC 1837 DIDGI 100 NO SPARE PART
				X=SIEHE GESONDERTE E-LISTE	X=SEE SEPARATE PARTS LIST
				ALLE WEITEREN TEILE SIEHE E-LISTE SEDANCE 70 ST 70-284 DOLBY SCHWARZ MAT.-NR.: 921921017500 BESTELL-NR.: GCK6500 AUSGABE 11/2000 VERSION NR.: VNM	FOR ALL OTHER PARTS SEE SEDANCE 70 ST 70-284 DOLBY BLACK PART NO: 921921017500 ORDER NR: GCK6500 EDITION 11/2000 VERSION NO.: VNM

ÄNDERUNGEN VORBEHALTEN / SUBJECT TO ALTERATION

POS. NR.    MATERIAL-NR.    BEZEICHNUNG  
POS. NO.    PART NUMBER    DESCRIPTION

POS. NR.    MATERIAL-NR.    BEZEICHNUNG  
POS. NO.    PART NUMBER    DESCRIPTION

## SEDANCE 70 ST 70-284 DOLBY

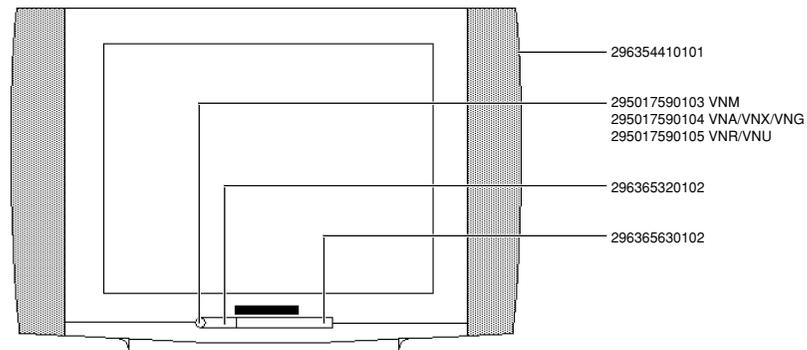

Es gelten die Vorschriften und Sicherheitshinweise gemäß dem Service Manual "Sicherheit", Mat.-Nummer 720108000000, sowie zusätzlich die eventuell abweichenden, landesspezifischen Vorschriften!



The regulations and safety instructions shall be valid as provided by the "Safety" Service Manual, part number 720108000000, as well as the respective national deviations.

ÄNDERUNGEN VORBEHALTEN / SUBJECT TO ALTERATION

### SEDANCE 70 ST 70-284 DOLBY

MATERIAL-NR. / PART NO.: 921921019200 BESTELL-NR. / ORDER NO.: GCK6592 TITANE  
VERSION NR./VERSION NO.: VNA

POS. NR. POS. NO.	ABB. FIG.	MATERIAL-NR. PART NUMBER	ANZ. QTY.	BEZEICHNUNG (D)	DESCRIPTION (GB)
		921921019200		SEDANCE 70 ST 70-284 DOLBY TITANE KEIN E-TEIL	SEDANCE 70 ST 70-284 DOLBY TITANE NO SPARE PART
0050.000				PROGRAMM FLASH-EPROM DOWNLOAD: WWW.GRUNDIG.DE/ PRODUKTE/KONTAKT/HAENDLERSERVICE	PROGRAM FLASH EPROM DOWNLOAD: WWW.GRUNDIG.DE/ PRODUCTS/CONTACT/RESELLER SUPPORT
0218.000		295017590104		RAHMEN M.TASTENKNOPF NETZ KPL	FRAME W.KEY POWER CPL
0320.000		291104616401		TYPENAUFKLEBER VNA	TYPE LABEL VNA
0700.000	△	092461317506		ENTMAGNETISIERUNGSSPULE M.HALTER	DEGAUSSING COIL W.HOLDER
0950.000		292104087100		SHIFTSTECKER KPL 4 W/120 OHM	SHIFT PLUG CPL 4 W/120 OHM
0950.000		292104087406		SHIFTSTECKER KPL 4W/220 OHM	SHIFT PLUG CPL 4W/220 OHM
1100.000		830003047400		BILDR.A66EAK554X44	PICT.TUBE A66EAK554X44
1110.000	△	292013601106		ANODENKAPPE M.HOCHSPANNUNGSKABEL	ANODE CAP W.HIGH VOLTAGE CABLE
2400.000		296420614600		TP 100 C FERNBEDIENUNG SCHWARZ	TP 100 C REMOTE CONTROL BLACK
2410.000		720086730000		DECKEL BATTERIE TP 100 C	BATTERY LID TP 100 C
		219219412000		BEDIENUNGSANLEITUNG D	OPERATING INSTRUCTIONS D
		219219412100		BEDIENUNGSANLEITUNG F/I	OPERATING INSTRUCTIONS F/I
		219219412200		BEDIENUNGSANLEITUNG GB/NL	OPERATING INSTRUCTIONS GB/NL
		720100305000		SERVICE MANUAL D/GB	SERVICE MANUAL D/GB
		720100305400		SERVICE MANUAL D/GB 4.ERGAENZUNG	SERVICE MANUAL D/GB 4TH SUPPLEMENT
		720100305500		SERVICE MANUAL D/GB 5.ERGAENZUNG	SERVICE MANUAL D/GB 5TH SUPPLEMENT
		720100305600		SERVICE MANUAL D/GB 6.ERGAENZUNG	SERVICE MANUAL D/GB 6TH SUPPLEMENT
		297040110100	X	CHASSIS-FS-STEREO CUC 1837 DIDGI 100 KEIN E-TEIL	CHASSIS TV STEREO CUC 1837 DIDGI 100 NO SPARE PART
				X=SIEHE GESONDORTE E-LISTE	X=SEE SEPARATE PARTS LIST
				ALLE WEITEREN TEILE SIEHE E-LISTE SEDANCE 70 ST 70-284 DOLBY TITANE MAT.-NR.: 921921019200 BESTELL-NR.: GCK6592 AUSGABE 11/2000 VERSION NR.: VNM	FOR ALL OTHER PARTS SEE SEDANCE 70 ST 70-284 DOLBY TITANE PART NO: 921921019200 ORDER NR: GCK6592 EDITION 11/2000 VERSION NO.: VNM

ÄNDERUNGEN VORBEHALTEN / SUBJECT TO ALTERATION

POS. NR. MATERIAL-NR. BEZEICHNUNG  
POS. NO. PART NUMBER DESCRIPTION

POS. NR. MATERIAL-NR. BEZEICHNUNG  
POS. NO. PART NUMBER DESCRIPTION

### SEDANCE 70 ST 70-284 DOLBY

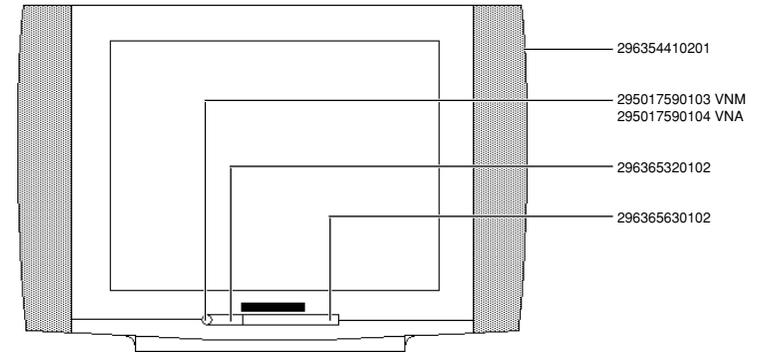

Es gelten die Vorschriften und Sicherheitshinweise gemäß dem Service Manual "Sicherheit", Mat.-Nummer 720108000000, sowie zusätzlich die eventuell abweichenden, landesspezifischen Vorschriften!



The regulations and safety instructions shall be valid as provided by the "Safety" Service Manual, part number 720108000000, as well as the respective national deviations.

ÄNDERUNGEN VORBEHALTEN / SUBJECT TO ALTERATION

Ersatzteilliste  
Spare Parts List

6 / 2002

**SEDANCE 70 ST 70-284 DOLBY**

MATERIAL-NR. / PART NO.: 921921019200 BESTELL-NR. / ORDER NO.: GCK6592 TITANE  
VERSION NR./VERSION NO.: VNX

POS. NR. POS. NO.	ABB. FIG.	MATERIAL-NR. PART NUMBER	ANZ. QTY.	BEZEICHNUNG (D)	DESCRIPTION (GB)
		921921019200		SEDANCE 70 ST 70-284 DOLBY TITANE KEIN E-TEIL	SEDANCE 70 ST 70-284 DOLBY TITANE NO SPARE PART
0050.000				PROGRAMM FLASH-EPROM DOWNLOAD: WWW.GRUNDIG.DE/ PRODUKTE/KONTAKT/HAENDLERSERVICE	PROGRAM FLASH EPROM DOWNLOAD: WWW.GRUNDIG.DE/ PRODUCTS/CONTACT/RESELLER SUPPORT
0218.000 0320.000 0700.000 0950.000 0950.000	△	295017590104 291103816501 092461317506 292104087100 292104087406		RAHMEN M.TASTENKNOPF NETZ KPL TYPENAUFKLEBER VNX ENTMAGNETISIERUNGSSPULE M.HALTER SHIFTSTECKER KPL 4 W/120 OHM SHIFTSTECKER KPL 4W/220 OHM	FRAME W.KEY POWER CPL TYPE LABEL VNX DEGAUSSING COIL W.HOLDER SHIFT PLUG CPL 4 W/120 OHM SHIFT PLUG CPL 4W/220 OHM
2400.000 2410.000		296420660300 720086745000		TP 150 C FERNBEDIENUNG SCHWARZ DECKEL BATTERIE TP 150 C	TP 150 C REMOTE CONTROL BLACK BATTERY LID TP 150 C
219219413100 219219413200 219219413300 720100305000 720100305400 720100305500 720100305600				BEDIENUNGSANLEITUNG D BEDIENUNGSANLEITUNG F/I BEDIENUNGSANLEITUNG GB/NL SERVICE MANUAL D/GB SERVICE MANUAL D/GB 4.ERGAENZUNG SERVICE MANUAL D/GB 5.ERGAENZUNG SERVICE MANUAL D/GB 6.ERGAENZUNG	OPERATING INSTRUCTIONS D OPERATING INSTRUCTIONS F/I OPERATING INSTRUCTIONS GB/NL SERVICE MANUAL D/GB SERVICE MANUAL D/GB 4TH SUPPLEMENT SERVICE MANUAL D/GB 5TH SUPPLEMENT SERVICE MANUAL D/GB 6TH SUPPLEMENT

ALLE WEITEREN TEILE SIEHE E-LISTE  
SEDANCE 70 ST 70-284 DOLBY TITANE  
MAT.-NR.: 921921019200  
BESTELL-NR.: GCK6592  
AUSGABE 11/2000  
VERSION NR.: VNM

FOR ALL OTHER PARTS SEE  
SEDANCE 70 ST 70-284 DOLBY TITANE  
PART NO.: 921921019200  
ORDER NR.: GCK6592  
EDITION 11/2000  
VERSION NO.: VNM

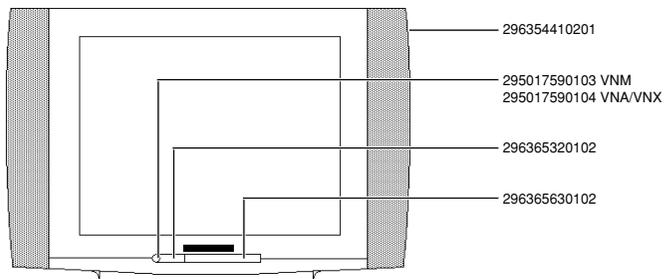

Es gelten die Vorschriften und Sicherheitshinweise gemäß dem Service Manual "Sicherheit", Mat.-Nummer 720108000000, sowie zusätzlich die eventuell abweichenden, landesspezifischen Vorschriften!



The regulations and safety instructions shall be valid as provided by the "Safety" Service Manual, part number 720108000000, as well as the respective national deviations.

ÄNDERUNGEN VORBEHALTEN / SUBJECT TO ALTERATION

Ersatzteilliste  
Spare Parts List

6 / 2002

**SEDANCE 70 ST 70-284 DOLBY**

MATERIAL-NR. / PART NO.: 921921019200 BESTELL-NR. / ORDER NO.: GCK6592 TITANE  
VERSION NR./VERSION NO.: VNG

POS. NR. POS. NO.	ABB. FIG.	MATERIAL-NR. PART NUMBER	ANZ. QTY.	BEZEICHNUNG (D)	DESCRIPTION (GB)
		921921019200		SEDANCE 70 ST 70-284 DOLBY TITANE KEIN E-TEIL	SEDANCE 70 ST 70-284 DOLBY TITANE NO SPARE PART
0050.000				PROGRAMM FLASH-EPROM DOWNLOAD: WWW.GRUNDIG.DE/ PRODUKTE/KONTAKT/HAENDLERSERVICE	PROGRAM FLASH EPROM DOWNLOAD: WWW.GRUNDIG.DE/ PRODUCTS/CONTACT/RESELLER SUPPORT
0218.000 0320.000 0700.000 0950.000 0950.000 1100.000 1110.000	△	295017590104 291104616601 092461317506 292104087100 292104087406 830003047400 292013601106		RAHMEN M.TASTENKNOPF NETZ KPL TYPENAUFKLEBER VNG ENTMAGNETISIERUNGSSPULE M.HALTER SHIFTSTECKER KPL 4 W/120 OHM SHIFTSTECKER KPL 4W/220 OHM BILDR. A66EAK554X44 ANODENKAPPE M.HOCHSPANNUNGSKABEL	FRAME W.KEY POWER CPL TYPE LABEL VNG DEGAUSSING COIL W.HOLDER SHIFT PLUG CPL 4 W/120 OHM SHIFT PLUG CPL 4W/220 OHM PICT.TUBE A66EAK554X44 ANODE CAP W.HIGH VOLTAGE CABLE
2400.000 2410.000		296420660300 720086745000		TP 150 C FERNBEDIENUNG SCHWARZ DECKEL BATTERIE TP 150 C	TP 150 C REMOTE CONTROL BLACK BATTERY LID TP 150 C
219219413500 219219413600 219219413700 720100305000 720100305400 720100305500 720100305600				BEDIENUNGSANLEITUNG D BEDIENUNGSANLEITUNG F/I BEDIENUNGSANLEITUNG GB/NL SERVICE MANUAL D/GB SERVICE MANUAL D/GB 4.ERGAENZUNG SERVICE MANUAL D/GB 5.ERGAENZUNG SERVICE MANUAL D/GB 6.ERGAENZUNG	OPERATING INSTRUCTIONS D OPERATING INSTRUCTIONS F/I OPERATING INSTRUCTIONS GB/NL SERVICE MANUAL D/GB SERVICE MANUAL D/GB 4TH SUPPLEMENT SERVICE MANUAL D/GB 5TH SUPPLEMENT SERVICE MANUAL D/GB 6TH SUPPLEMENT

297040110100 X CHASSIS-FS-STEREO  
CUC 1837 DIDGI 100  
KEIN E-TEIL

X=SIEHE GESONDERTE E-LISTE

CHASSIS TV STEREO  
CUC 1837 DIDGI 100  
NO SPARE PART

X=SEE SEPARATE PARTS LIST

ALLE WEITEREN TEILE SIEHE E-LISTE  
SEDANCE 70 ST 70-284 DOLBY TITANE  
MAT.-NR.: 921921019200  
BESTELL-NR.: GCK6592  
AUSGABE 11/2000  
VERSION NR.: VNM

FOR ALL OTHER PARTS SEE  
SEDANCE 70 ST 70-284 DOLBY TITANE  
PART NO.: 921921019200  
ORDER NR.: GCK6592  
EDITION 11/2000  
VERSION NO.: VNM

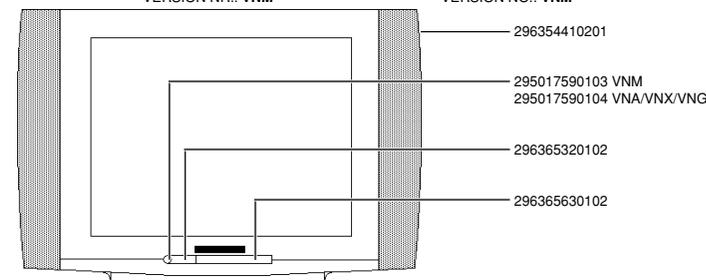

Es gelten die Vorschriften und Sicherheitshinweise gemäß dem Service Manual "Sicherheit", Mat.-Nummer 720108000000, sowie zusätzlich die eventuell abweichenden, landesspezifischen Vorschriften!



The regulations and safety instructions shall be valid as provided by the "Safety" Service Manual, part number 720108000000, as well as the respective national deviations.

ÄNDERUNGEN VORBEHALTEN / SUBJECT TO ALTERATION

MATERIAL-NR. / PART NO.: 921921019200 BESTELL-NR. / ORDER NO.: GCK6592 TITANE  
VERSION NR./VERSION NO.: VNR

POS. NR. POS. NO.	ABB. FIG.	MATERIAL-NR. PART NUMBER	ANZ. QTY.	BEZEICHNUNG (D)	DESCRIPTION (GB)
		921921019200		SEDANCE 70 ST 70-284 DOLBY TITANE KEIN E-TEIL	SEDANCE 70 ST 70-284 DOLBY TITANE NO SPARE PART
0050.000				PROGRAMM FLASH-EPROM DOWNLOAD: WWW.GRUNDIG.DE/ PRODUKTE/KONTAKT/HAENDLERSERVICE	PROGRAM FLASH EPROM DOWNLOAD: WWW.GRUNDIG.DE/ PRODUCTS/CONTACT/RESELLER SUPPORT
0218.000		295017590105		RAHMEN M.TASTENKNOPF NETZ KPL	FRAME W.KEY POWER CPL
0300.000		296319810801		GEH-RUECKTEIL OFB	CABINET REAR PART SURFACE TREATED
0320.000		291103816701		TYPENAUFKLEBER VNR	TYPE LABEL VNR
0700.000	△	092461317507		ENTMAGNETISIERUNGSSPULE M.HALTER	DEGAUSSING COIL W.HOLDER
0950.000		292104087100		SHIFTSTECKER KPL 4 W/120 OHM	SHIFT PLUG CPL 4 W/120 OHM
0950.000		292104087406		SHIFTSTECKER KPL 4W/220 OHM	SHIFT PLUG CPL 4W/220 OHM
2400.000		296420660300		TP 150 C FERNBEDIENUNG SCHWARZ	TP 150 C REMOTE CONTROL BLACK
2410.000		720086745000		DECKEL BATTERIE TP 150 C	BATTERY LID TP 150 C
219219413100				BEDIENUNGSANLEITUNG D	OPERATING INSTRUCTIONS D
219219413200				BEDIENUNGSANLEITUNG F/I	OPERATING INSTRUCTIONS F/I
219219413300				BEDIENUNGSANLEITUNG GB/NL	OPERATING INSTRUCTIONS GB/NL
720100305000				SERVICE MANUAL D/GB	SERVICE MANUAL D/GB
720100305400				SERVICE MANUAL D/GB 4.ERGAENZUNG	SERVICE MANUAL D/GB 4TH SUPPLEMENT
720100305500				SERVICE MANUAL D/GB 5.ERGAENZUNG	SERVICE MANUAL D/GB 5TH SUPPLEMENT
720100305600				SERVICE MANUAL D/GB 6.ERGAENZUNG	SERVICE MANUAL D/GB 6TH SUPPLEMENT
297040190800	X			CHASSIS-FS-STEREO CUC 1837 DIDGI 100 KEIN E-TEIL	CHASSIS TV STEREO CUC 1837 DIDGI 100 NO SPARE PART
				X=SIEMER GESONDERTE E-LISTE	X=SEE SEPARATE PARTS LIST
				ALLE WEITEREN TEILE SIEHE E-LISTE SEDANCE 70 ST 70-284 DOLBY TITANE MAT.-NR.: 921921019200 BESTELL-NR.: GCK6592 AUSGABE 11/2000 VERSION NR.: VNM	FOR ALL OTHER PARTS SEE SEDANCE 70 ST 70-284 DOLBY TITANE PART NO.: 921921019200 ORDER NR.: GCK6592 EDITION 11/2000 VERSION NO.: VNM

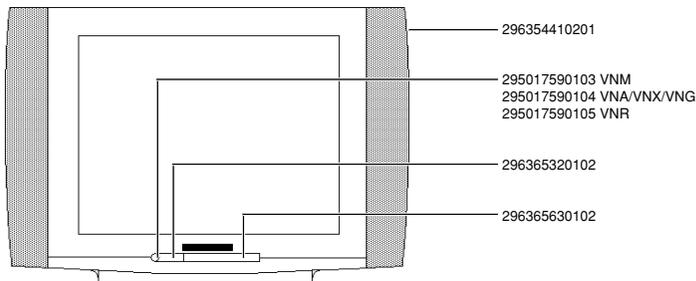

Es gelten die Vorschriften und Sicherheitshinweise gemäß dem Service Manual "Sicherheit", Mat.-Nummer 720108000000, sowie zusätzlich die eventuell abweichenden, landesspezifischen Vorschriften!



The regulations and safety instructions shall be valid as provided by the "Safety" Service Manual, part number 720108000000, as well as the respective national deviations.

ÄNDERUNGEN VORBEHALTEN / SUBJECT TO ALTERATION

MATERIAL-NR. / PART NO.: 921921019200 BESTELL-NR. / ORDER NO.: GCK6592 TITANE  
VERSION NR./VERSION NO.: VNU

POS. NR. POS. NO.	ABB. FIG.	MATERIAL-NR. PART NUMBER	ANZ. QTY.	BEZEICHNUNG (D)	DESCRIPTION (GB)
		921921019200		EDANCE 70 ST 70-284 DOLBY TITANE KEIN E-TEIL	SEDANCE 70 ST 70-284 DOLBY TITANE NO SPARE PART
0050.000				PROGRAMM FLASH-EPROM DOWNLOAD: WWW.GRUNDIG.DE/ PRODUKTE/KONTAKT/HAENDLERSERVICE	PROGRAM FLASH EPROM DOWNLOAD: WWW.GRUNDIG.DE/ PRODUCTS/CONTACT/RESELLER SUPPORT
0218.000		295017590105		RAHMEN M.TASTENKNOPF NETZ KPL	FRAME W.KEY POWER CPL
0300.000		296319810801		GEH-RUECKTEIL OFB	CABINET REAR PART SURFACE TREATED
0320.000		291104616801		TYPENAUFKLEBER VNU	TYPE LABEL VNU
0700.000	△	092461317507		ENTMAGNETISIERUNGSSPULE M.HALTER	DEGAUSSING COIL W.HOLDER
0950.000		292104087100		SHIFTSTECKER KPL 4 W/120 OHM	SHIFT PLUG CPL 4 W/120 OHM
0950.000		292104087406		SHIFTSTECKER KPL 4W/220 OHM	SHIFT PLUG CPL 4W/220 OHM
1100.000		830003047400		BILDR.A66EAK554X44 31KV PHILIPS	PICT.TUBE A66EAK554X44 31KV PHILIPS
1100.000	△	292013601106		ANODENKAPPE M.HOCHSPANNUNGSKABEL	ANODE CAP W.HIGH VOLTAGE CABLE
2400.000		296420660300		TP 150 C FERNBEDIENUNG SCHWARZ	TP 150 C REMOTE CONTROL BLACK
2410.000		720086745000		DECKEL BATTERIE TP 150 C	BATTERY LID TP 150 C
219219413500				BEDIENUNGSANLEITUNG D	OPERATING INSTRUCTIONS D
219219413600				BEDIENUNGSANLEITUNG F/I	OPERATING INSTRUCTIONS F/I
219219413700				BEDIENUNGSANLEITUNG GB/NL	OPERATING INSTRUCTIONS GB/NL
720100305000				SERVICE MANUAL D/GB	SERVICE MANUAL D/GB
720100305400				SERVICE MANUAL D/GB 4.ERGAENZUNG	SERVICE MANUAL D/GB 4TH SUPPLEMENT
720100305500				SERVICE MANUAL D/GB 5.ERGAENZUNG	SERVICE MANUAL D/GB 5TH SUPPLEMENT
720100305600				SERVICE MANUAL D/GB 6.ERGAENZUNG	SERVICE MANUAL D/GB 6TH SUPPLEMENT
297040194800	X			CHASSIS-FS-STEREO CUC 1837 DIDGI 100 KEIN E-TEIL	CHASSIS TV STEREO CUC 1837 DIDGI 100 NO SPARE PART
				X=SIEMER GESONDERTE E-LISTE	X=SEE SEPARATE PARTS LIST
				ALLE WEITEREN TEILE SIEHE E-LISTE SEDANCE 70 ST 70-284 DOLBY TITANE MAT.-NR.: 921921019200 BESTELL-NR.: GCK6592 AUSGABE 11/2000 VERSION NR.: VNM	FOR ALL OTHER PARTS SEE SEDANCE 70 ST 70-284 DOLBY TITANE PART NO.: 921921019200 ORDER NR.: GCK6592 EDITION 11/2000 VERSION NO.: VNM

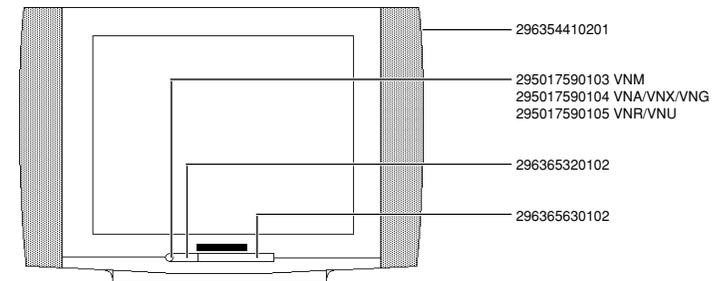

Es gelten die Vorschriften und Sicherheitshinweise gemäß dem Service Manual "Sicherheit", Mat.-Nummer 720108000000, sowie zusätzlich die eventuell abweichenden, landesspezifischen Vorschriften!



The regulations and safety instructions shall be valid as provided by the "Safety" Service Manual, part number 720108000000, as well as the respective national deviations.

ÄNDERUNGEN VORBEHALTEN / SUBJECT TO ALTERATION

## Ersatzteilliste Spare Parts List

### 6 / 2002

### SEDANCE 70 ST 70-284/8 DOLBY

MATERIAL-NR. / PART NO.: 921921027500    BESTELL-NR. / ORDER NO.: GCK6675    SCHWARZ/BLACK  
 VERSION NR./VERSION NO.: **VNA**

POS. NR. POS. NO.	ABB. FIG.	MATERIAL-NR. PART NUMBER	ANZ. QTY.	BEZEICHNUNG (D)	DESCRIPTION (GB)
		921921027500		SEDANCE 70 ST 70-284/8 DOLBY SCHWARZ KEIN E-TEIL	SEDANCE 70 ST 70-284/8 DOLBY BLACK NO SPARE PART
0050.000				PROGRAMM FLASH-EPROM DOWNLOAD: WWW.GRUNDIG.DE/ PRODUKTE/KONTAKT/HAENDLERSERVICE	PROGRAM FLASH EPROM DOWNLOAD: WWW.GRUNDIG.DE/ PRODUCTS/CONTACT/RESELLER SUPPORT
0215.000		295017590104		RAHMEN M.TASTENKNOPF NETZ KPL	FRAME W.KEY POWER CPL
0240.000		293033904200		KOPFHÖRERBUCHSE 3,5 O.SCHALTER	HEADPHONE SOCKET 3.5 W/O SWITCH
0241.000		293031680503		CINCH-BUCHSE 3-FACH FBAS/NF L,R	CINCH SOCKET 3 FOLD FBAS/AF L,R
0320.000		291104626401		TYPENAUFKLEBER VNA	TYPE LABEL VNA
0700.000	△	092461317506		ENTMAGNETISIERUNGSSPULE M.HALTER	DEGAUSSING COIL W.HOLDER
0950.000		292104087100		SHIFTSTECKER KPL 4 W/120 OHM	SHIFT PLUG CPL 4 W/120 OHM
0950.000		292104087406		SHIFTSTECKER KPL 4W/220 OHM	SHIFT PLUG CPL 4W/220 OHM
1100.000		830003047400		BILDR.A66EAK554X44 (31KV) PHILIPS	PICT.TUBE A66EAK554X44 (31KV) PHILIPS
1200.000	△	292013601106		ANODENKAPPE M.HOCHSPANNUNGSKABEL	ANODE CAP W.HIGH VOLTAGE CABLE
2400.000		296420614600		TP 100 C FERNBEDIENUNG SCHWARZ	TP 100 C REMOTE CONTROL BLACK
2410.000		720086730000		DECKEL BATTERIE TP 100 C	BATTERY LID TP 100 C
		219219412400		BEDIENUNGSANLEITUNG D	OPERATING INSTRUCTIONS D
		219219412500		BEDIENUNGSANLEITUNG F/I	OPERATING INSTRUCTIONS F/I
		219219412600		BEDIENUNGSANLEITUNG GB/NL	OPERATING INSTRUCTIONS GB/NL
		219219412700		BEDIENUNGSANLEITUNG E/P	OPERATING INSTRUCTIONS E/P
		219219412800		BEDIENUNGSANLEITUNG DK/FIN	OPERATING INSTRUCTIONS DK/FIN
		219219412900		BEDIENUNGSANLEITUNG S/N	OPERATING INSTRUCTIONS S/N
		720100305000		SERVICE MANUAL D/GB	SERVICE MANUAL D/GB
		720100305400		SERVICE MANUAL D/GB 4.ERGAENZUNG	SERVICE MANUAL D/GB 4TH SUPPLEMENT
		720100305500		SERVICE MANUAL D/GB 5.ERGAENZUNG	SERVICE MANUAL D/GB 5TH SUPPLEMENT
		720100305600		SERVICE MANUAL D/GB 6.ERGAENZUNG	SERVICE MANUAL D/GB 6TH SUPPLEMENT
		297040111500	X	CHASSIS-FS-STEREO CUC 1837 DIDGI 100 KEIN E-TEIL	CHASSIS TV STEREO CUC 1837 DIDGI 100 NO SPARE PART
				X= SIEHE GESONDERTE E-LISTE	X= SEE SEPARATE PARTS LIST
				ALLE WEITEREN TEILE SIEHE E-LISTE SEDANCE 70 ST 70-284/8 DOLBY SCHWARZ MAT.-NR.: 921921027500 BESTELL-NR.: GCK6675 AUSGABE 1/2001 VERSION NR.: <b>VNM</b>	FOR ALL OTHER PARTS SEE SEDANCE 70 ST 70-284/8 DOLBY BLACK PART NO.: 921921027500 ORDER NR.: GCK6675 EDITION 1/2001 VERSION NO.: <b>VNM</b>

POS. NR. MATERIAL-NR. BEZEICHNUNG  
 POS. NO. PART NUMBER DESCRIPTION

POS. NR. MATERIAL-NR. BEZEICHNUNG  
 POS. NO. PART NUMBER DESCRIPTION

### SEDANCE 70 ST 70-284/8 DOLBY

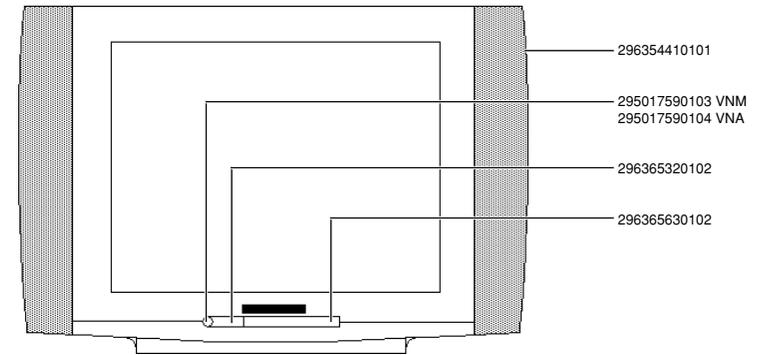

Es gelten die Vorschriften und Sicherheitshinweise gemäß dem Service Manual "Sicherheit", Mat.-Nummer 720108000000, sowie zusätzlich die eventuell abweichenden, landesspezifischen Vorschriften!



The regulations and safety instructions shall be valid as provided by the "Safety" Service Manual, part number 720108000000, as well as the respective national deviations.

### Ersatzteilliste Spare Parts List

6 / 2002

### SEDANCE 70 ST 70-284/8 DOLBY

MATERIAL-NR. / PART NO.: 921921027500    BESTELL-NR. / ORDER NO.: GCK6675    SCHWARZ/BLACK  
VERSION NR./VERSION NO.: **VNX**

POS. NR. POS. NO.	ABB. FIG.	MATERIAL-NR. PART NUMBER	ANZ. QTY.	BEZEICHNUNG <b>(D)</b>	DESCRIPTION <b>(GB)</b>
		921921027500		SEDANCE 70 ST 70-284/8 DOLBY SCHWARZ KEIN E-TEIL	SEDANCE 70 ST 70-284/8 DOLBY BLACK NO SPARE PART
0050.000				PROGRAMM FLASH-EPROM DOWNLOAD: WWW.GRUNDIG.DE/ PRODUKTE/KONTAKT/HAENDLERSERVICE	PROGRAM FLASH EPROM DOWNLOAD: WWW.GRUNDIG.DE/ PRODUCTS/CONTACT/RESELLER SUPPORT
0215.000		295017590104		RAHMEN M.TASTENKNOPF NETZ KPL	FRAME W.KEY POWER CPL
0240.000		293033904200		KOPFHOERERBUCHSE 3,5 O.SCHALTER	HEADPHONE SOCKET 3,5 W/O SWITCH
0241.000		293031680503		CINCH-BUCHSE 3-FACH FBAS/NF L,R	CINCH SOCKET 3 FOLD FBAS/AF L,R
0320.000		291102156504		TYPENAUFKLEBER VNX 29KV PHILIPS-BR	TYPE LABEL VNX 29KV PHILIPS PT
0320.000		291102966503		TYPENAUFKLEBER VNX <b>31KV PANASONIC-BR</b>	TYPE LABEL VNX <b>31KV PANASONIC PT</b>
0700.000	△	092461317506		ENTMAGNETISIERUNGSSPULE M.HALTER	DEGAUSSING COIL W.HOLDER
0950.000		292104087100		SHIFTSTECKER KPL 4 W/120 OHM	SHIFT PLUG CPL 4 W/120 OHM
0950.000		292104087406		SHIFTSTECKER KPL 4W/220 OHM	SHIFT PLUG CPL 4W/220 OHM
1100.000	△	830003043600		BILDR.A66EAK075X44 <b>29KV PHILIPS</b>	PICT.TUBE A66EAK075X44 <b>29KV PHILIPS</b>
1100.000		830003048500		BILDR.A66ECF50X56 <b>31KV PANASONIC</b>	PICT.TUBE A66ECF50X56 <b>31KV PANASONIC</b>
2400.000		296420660300		TP 150 C FERNBEDIENUNG SCHWARZ	TP 150 C REMOTE CONTROL BLACK
2410.000		720086745000		DECKEL BATTERIE TP 150 C	BATTERY LID TP 150 C
2505.000		219219413900		<b>FUER BILDR.A66EAK075X44 29KV PHILIPS</b> BEDIENUNGSANLEITUNG D	<b>FOR PICT.TUBE A66EAK075X44 29KV PHILIPS</b> OPERATING INSTRUCTIONS D
2510.000		219219414000		BEDIENUNGSANLEITUNG F/I	OPERATING INSTRUCTIONS F/I
2515.000		219219414100		BEDIENUNGSANLEITUNG GB/NL	OPERATING INSTRUCTIONS GB/NL
2520.000		219219414200		BEDIENUNGSANLEITUNG E/P	OPERATING INSTRUCTIONS E/P
2525.000		219219414300		BEDIENUNGSANLEITUNG DK/FIN	OPERATING INSTRUCTIONS DK/FIN
2530.000		219219414400		BEDIENUNGSANLEITUNG S/N	OPERATING INSTRUCTIONS S/N
		219219414600		<b>FUER BILDR.A66ECF50X56 31KV PANASONIC</b> BEDIENUNGSANLEITUNG D	<b>FOR PICT.TUBE A66ECF50X56 31KV PANASONIC</b> OPERATING INSTRUCTIONS D
		219219414700		BEDIENUNGSANLEITUNG F/I	OPERATING INSTRUCTIONS F/I
		219219414800		BEDIENUNGSANLEITUNG GB/NL	OPERATING INSTRUCTIONS GB/NL
		219219414900		BEDIENUNGSANLEITUNG E/P	OPERATING INSTRUCTIONS E/P
		219219415000		BEDIENUNGSANLEITUNG DK/FIN	OPERATING INSTRUCTIONS DK/FIN
		219219415100		BEDIENUNGSANLEITUNG S/N	OPERATING INSTRUCTIONS S/N
		720100305000		SERVICE MANUAL D/GB	SERVICE MANUAL D/GB
		720100305400		SERVICE MANUAL D/GB 4.ERGAENZUNG	SERVICE MANUAL D/GB 4TH SUPPLEMENT
		720100305500		SERVICE MANUAL D/GB 5.ERGAENZUNG	SERVICE MANUAL D/GB 5TH SUPPLEMENT
		720100305600		SERVICE MANUAL D/GB 6.ERGAENZUNG	SERVICE MANUAL D/GB 6TH SUPPLEMENT
				ALLE WEITEREN TEILE SIEHE E-LISTE SEDANCE 70 ST 70-284/8 DOLBY SCHWARZ MAT.-NR.: 921921027500 BESTELL-NR.: GCK6675 AUSGABE 1/2001 VERSION NR.: <b>VNM</b>	FOR ALL OTHER PARTS SEE SEDANCE 70 ST 70-284/8 DOLBY BLACK PART NO: 921921027500 ORDER NR: GCK6675 EDITION 1/2001 VERSION NO.: <b>VNM</b>

POS. NR. MATERIAL-NR. BEZEICHNUNG  
POS. NO. PART NUMBER DESCRIPTION

POS. NR. MATERIAL-NR. BEZEICHNUNG  
POS. NO. PART NUMBER DESCRIPTION

### SEDANCE 70 ST 70-284/8 DOLBY

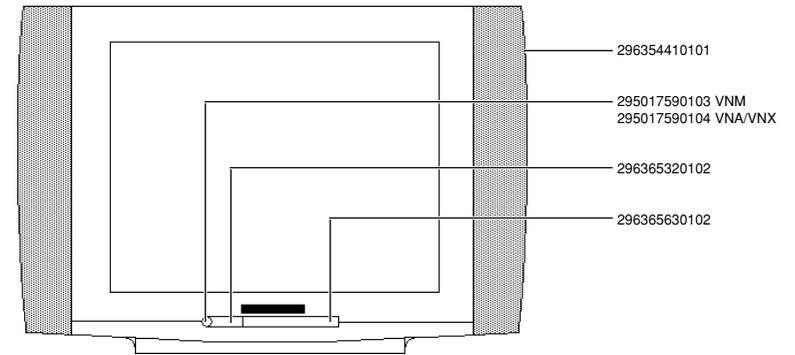

Es gelten die Vorschriften und Sicherheitshinweise gemäß dem Service Manual "Sicherheit", Mat.-Nummer 720108000000, sowie zusätzlich die eventuell abweichenden, landesspezifischen Vorschriften!



The regulations and safety instructions shall be valid as provided by the "Safety" Service Manual, part number 720108000000, as well as the respective national deviations.

ÄNDERUNGEN VORBEHALTEN / SUBJECT TO ALTERATION

ÄNDERUNGEN VORBEHALTEN / SUBJECT TO ALTERATION

## Ersatzteilliste Spare Parts List

6 / 2002

## SEDANCE 70 ST 70-284/8 DOLBY

MATERIAL-NR. / PART NO.: 921921027500 BESTELL-NR. / ORDER NO.: GCK6675 SCHWARZ/BLACK  
VERSION NR./VERSION NO.: VNG

POS. NR. POS. NO.	ABB. FIG.	MATERIAL-NR. PART NUMBER	ANZ. QTY.	BEZEICHNUNG <b>(D)</b>	DESCRIPTION <b>(GB)</b>
		921921027500		SEDANCE 70 ST 70-284/8 DOLBY SCHWARZ KEIN E-TEIL	SEDANCE 70 ST 70-284/8 DOLBY BLACK NO SPARE PART
0050.000				PROGRAMM FLASH-EPROM DOWNLOAD: WWW.GRUNDIG.DE/ PRODUKTE/KONTAKT/HAENDLERSERVICE	PROGRAM FLASH EPROM DOWNLOAD: WWW.GRUNDIG.DE/ PRODUCTS/CONTACT/RESELLER SUPPORT
0215.000		295017590104		RAHMEN M.TASTENKNOPF NETZ KPL	FRAME W.KEY POWER CPL
0240.000		293033904200		KOPFHOERERBUCHSE 3,5 O.SCHALTER	HEADPHONE SOCKET 3.5 W/O SWITCH
0241.000		293031680503		CINCH-BUCHSE 3-FACH FBAS/NF L,R	CINCH SOCKET 3 FOLD FBAS/AF L,R
0320.000		291104626601		TYPENAUFKLEBER VNG	TYPE LABEL VNG
0700.000	△	092461317506		ENTMAGNETISIERUNGSSPULE M.HALTER	DEGAUSSING COIL W.HOLDER
0950.000		292104087100		SHIFTSTECKER KPL 4 W/120 OHM	SHIFT PLUG CPL 4 W/120 OHM
0950.000		292104087406		SHIFTSTECKER KPL 4W/220 OHM	SHIFT PLUG CPL 4W/220 OHM
1100.000		830003047400		BILDR.A66EAK554X44 (31KV) PHILIPS	PICT.TUBE A66EAK554X44 (31KV) PHILIPS
1200.000	△	292013601106		ANODENKAPPE M.HOCHSPANNUNGSKABEL	ANODE CAP W.HIGH VOLTAGE CABLE
2400.000		296420660300		TP 100 C FERNBEDIENUNG SCHWARZ	TP 100 C REMOTE CONTROL BLACK
2410.000		720086745000		DECKEL BATTERIE TP 150 C	BATTERY LID TP 150 C
		219219415300		BEDIENUNGSANLEITUNG D	OPERATING INSTRUCTIONS D
		219219415400		BEDIENUNGSANLEITUNG F/I	OPERATING INSTRUCTIONS F/I
		219219415500		BEDIENUNGSANLEITUNG GB/NL	OPERATING INSTRUCTIONS GB/NL
		219219415600		BEDIENUNGSANLEITUNG E/P	OPERATING INSTRUCTIONS E/P
		219219415700		BEDIENUNGSANLEITUNG DK/FIN	OPERATING INSTRUCTIONS DK/FIN
		219219415800		BEDIENUNGSANLEITUNG S/N	OPERATING INSTRUCTIONS S/N
		720100305000		SERVICE MANUAL D/GB	SERVICE MANUAL D/GB
		720100305400		SERVICE MANUAL D/GB 4.ERGAENZUNG	SERVICE MANUAL D/GB 4TH SUPPLEMENT
		720100305500		SERVICE MANUAL D/GB 5.ERGAENZUNG	SERVICE MANUAL D/GB 5TH SUPPLEMENT
		720100305600		SERVICE MANUAL D/GB 6.ERGAENZUNG	SERVICE MANUAL D/GB 6TH SUPPLEMENT
		297040111500	X	CHASSIS-FS-STEREO CUC 1837 DIDGI 100 KEIN E-TEIL	CHASSIS TV STEREO CUC 1837 DIDGI 100 NO SPARE PART
				X=SIHE GESONDERTE E-LISTE	X=SEE SEPARATE PARTS LIST
				ALLE WEITEREN TEILE SIEHE E-LISTE SEDANCE 70 ST 70-284/8 DOLBY SCHWARZ MAT.-NR.: 921921027500 BESTELL-NR.: GCK6675 AUSGABE 1/2001 VERSION NR.: VNM	FOR ALL OTHER PARTS SEE SEDANCE 70 ST 70-284/8 DOLBY BLACK PART NO.: 921921027500 ORDER NR.: GCK6675 EDITION 1/2001 VERSION NO.: VNM

POS. NR. MATERIAL-NR. BEZEICHNUNG  
POS. NO. PART NUMBER DESCRIPTION

POS. NR. MATERIAL-NR. BEZEICHNUNG  
POS. NO. PART NUMBER DESCRIPTION

## SEDANCE 70 ST 70-284/8 DOLBY

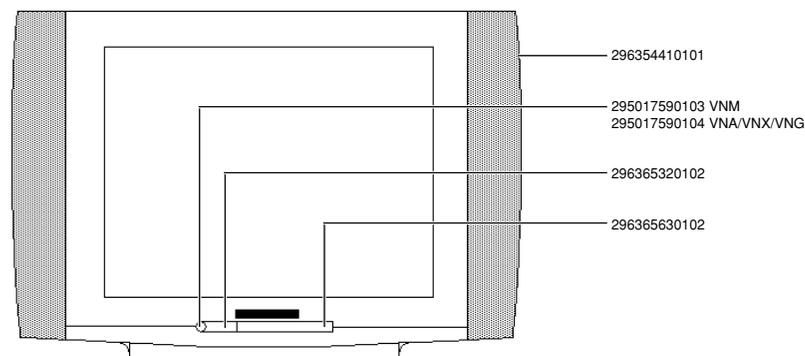

Es gelten die Vorschriften und Sicherheitshinweise gemäß dem Service Manual "Sicherheit", Mat.-Nummer 720108000000, sowie zusätzlich die eventuell abweichenden, landesspezifischen Vorschriften!



The regulations and safety instructions shall be valid as provided by the "Safety" Service Manual, part number 720108000000, as well as the respective national deviations.

### Ersatzteilliste Spare Parts List

6 / 2002

### SEDANCE 70 ST 70-284/8 DOLBY

MATERIAL-NR. / PART NO.: 921921027500 BESTELL-NR. / ORDER NO.: GCK6675 SCHWARZ/BLACK  
VERSION NR./VERSION NO.: VNR

POS. NR. ABB. POS. NO. FIG.	MATERIAL-NR. PART NUMBER	ANZ. QTY.	BEZEICHNUNG D	DESCRIPTION GB
	921921027500		SEDANCE 70 ST 70-284/8 DOLBY SCHWARZ KEIN E-TEIL	SEDANCE 70 ST 70-284/8 DOLBY BLACK NO SPARE PART
0050.000			PROGRAMM FLASH-EPROM DOWNLOAD: WWW.GRUNDIG.DE/ PRODUKTE/KONTAKT/HAENDLERSERVICE	PROGRAM FLASH EPROM DOWNLOAD: WWW.GRUNDIG.DE/ PRODUCTS/CONTACT/RESELLER SUPPORT
0215.000	295017590105		RAHMEN M.TASTENKNOPF NETZ KPL	FRAME W.KEY POWER CPL
0240.000	293033904200		KOPFHOERERBUCHSE 3,5 O.SCHALTER	HEADPHONE SOCKET 3.5 W/O SWITCH
0241.000	293031680503		CINCH-BUCHSE 3-FACH FBAS/NF L,R	CINCH SOCKET 3 FOLD FBAS/AF L,R
0300.000	296319810901		GEH-RUECKTEIL OFB	CABINET REAR PART SURFACE TREATED
0320.000	291102156704		TYPENAUFKLEBER VNR 29KV PHILIPS-BR	TYPE LABEL VNR 29KV PHILIPS PT
0320.000	291102966703		TYPENAUFKLEBER VNR 31KV PANASONIC-BR	TYPE LABEL VNR 31KV PANASONIC PT
0700.000	092461317507	△	ENTMAGNETISIERUNGSSPULE M.HALTER	DEGAUSSING COIL W.HOLDER
0950.000	292104087100		SHIFTSTECKER KPL 4 W/120 OHM	SHIFT PLUG CPL 4 W/120 OHM
0950.000	292104087406		SHIFTSTECKER KPL 4W/220 OHM	SHIFT PLUG CPL 4W/220 OHM
1100.000	830003043600	△	BILDR.A66EAK075X44 29KV PHILIPS	PICT.TUBE A66EAK075X44 29KV PHILIPS
1100.000	830003048500		BILDR.A66ECF50X56 31KV PANASONIC	PICT.TUBE A66ECF50X56 31KV PANASONIC
2400.000	296420660300		TP 150 C FERNBEDIENUNG SCHWARZ	TP 150 C REMOTE CONTROL BLACK
2410.000	720086745000		DECKEL BATTERIE TP 150 C	BATTERY LID TP 150 C BLAC
			<b>FUER BILDR.A66EAK075X44 29KV PHILIPS</b>	<b>FOR PICT.TUBE A66EAK075X44 29KV PHILIPS</b>
			BEDIENUNGSANLEITUNG D	OPERATING INSTRUCTIONS D
			BEDIENUNGSANLEITUNG F/I	OPERATING INSTRUCTIONS F/I
			BEDIENUNGSANLEITUNG GB/NL	OPERATING INSTRUCTIONS GB/NL
			BEDIENUNGSANLEITUNG E/P	OPERATING INSTRUCTIONS E/P
			BEDIENUNGSANLEITUNG DK/FIN	OPERATING INSTRUCTIONS DK/FIN
			BEDIENUNGSANLEITUNG S/N	OPERATING INSTRUCTIONS S/N
			<b>FUER BILDR.A66ECF50X56 31KV PANASONIC</b>	<b>FOR PICT.TUBE A66ECF50X56 31KV PANASONIC</b>
			BEDIENUNGSANLEITUNG D	OPERATING INSTRUCTIONS D
			BEDIENUNGSANLEITUNG F/I	OPERATING INSTRUCTIONS F/I
			BEDIENUNGSANLEITUNG GB/NL	OPERATING INSTRUCTIONS GB/NL
			BEDIENUNGSANLEITUNG E/P	OPERATING INSTRUCTIONS E/P
			BEDIENUNGSANLEITUNG DK/FIN	OPERATING INSTRUCTIONS DK/FIN
			BEDIENUNGSANLEITUNG S/N	OPERATING INSTRUCTIONS S/N
			SERVICE MANUAL D/GB	SERVICE MANUAL D/GB
			SERVICE MANUAL D/GB 4.ERGAENZUNG	SERVICE MANUAL D/GB 4TH SUPPLEMENT
			SERVICE MANUAL D/GB 5.ERGAENZUNG	SERVICE MANUAL D/GB 5TH SUPPLEMENT
			SERVICE MANUAL D/GB 6.ERGAENZUNG	SERVICE MANUAL D/GB 6TH SUPPLEMENT
297040190900	X		CHASSIS-FS-STEREO 29KV PHILIPS-BR CUC 1837 DIDGI 100 KEIN E-TEIL	CHASSIS TV STEREO 29KV PHILIPS PT CUC 1837 DIDGI 100 NO SPARE PART
297040194900	X		CHASSIS-FS-STEREO 31KV PANASONIC-BR CUC 1837 DIDGI 100 KEIN E-TEIL	CHASSIS TV STEREO 31KV PANASONIC PT CUC 1837 DIDGI 100 NO SPARE PART
			X-SIEHE GESONDERTE E-LISTE	X=SEE SEPARATE PARTS LIST
			ALLE WEITEREN TEILE SIEHE E-LISTE SEDANCE 70 ST 70-284/8 DOLBY SCHWARZ	FOR ALL OTHER PARTS SEE SEDANCE 70 ST 70-284/8 DOLBY BLACK

ÄNDERUNGEN VORBEHALTEN / SUBJECT TO ALTERATION

POS. NR. ABB. POS. NO. FIG.	MATERIAL-NR. PART NUMBER	ANZ. QTY.	BEZEICHNUNG D	DESCRIPTION GB
			MAT.-NR.: 921921027500 BESTELL-NR.: GCK6675 AUSGABE 1/2001 VERSION NR.: VNM	PART NO: 921921027500 ORDER NR: GCK6675 EDITION 1/2001 VERSION NO.: VNM

### SEDANCE 70 ST 70-284/8 DOLBY

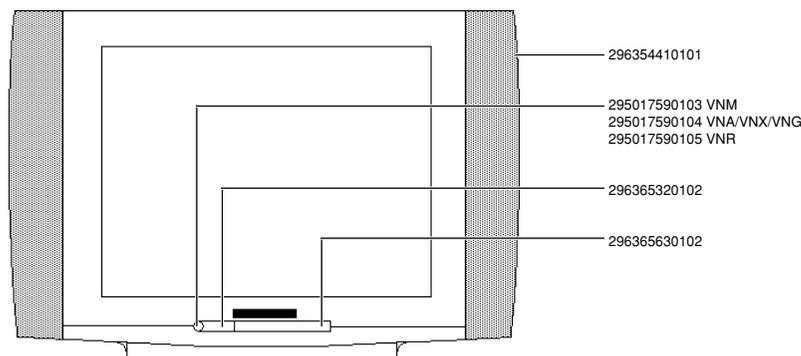

Es gelten die Vorschriften und Sicherheitshinweise gemäß dem Service Manual "Sicherheit", Mat.-Nummer 720108000000, sowie zusätzlich die eventuell abweichenden, landesspezifischen Vorschriften!



The regulations and safety instructions shall be valid as provided by the "Safety" Service Manual, part number 720108000000, as well as the respective national deviations.

ÄNDERUNGEN VORBEHALTEN / SUBJECT TO ALTERATION

MATERIAL-NR. / PART NO.: 921921027500 BESTELL-NR. / ORDER NO.: GCK6675 SCHWARZ/BLACK  
VERSION NR./VERSION NO.: VNU

POS. NR. POS. NO.	ABB. FIG.	MATERIAL-NR. PART NUMBER	ANZ. QTY.	BEZEICHNUNG ①	DESCRIPTION ②
		921921027500		SEDANCE 70 ST 70-284/8 DOLBY SCHWARZ KEIN E-TEIL	SEDANCE 70 ST 70-284/8 DOLBY BLACK NO SPARE PART
0050.000				PROGRAMM FLASH-EPROM DOWNLOAD: WWW.GRUNDIG.DE/ PRODUKTE/KONTAKT/HAENDLERSERVICE	PROGRAM FLASH EPROM DOWNLOAD: WWW.GRUNDIG.DE/ PRODUCTS/CONTACT/RESELLER SUPPORT
0215.000		295017590105		RAHMEN M.TASTENKNOPF NETZ KPL	FRAME W.KEY POWER CPL
0240.000		293033904200		KOPFHUERERBUCHSE 3,5 O.SCHALTER	HEADPHONE SOCKET 3.5 W/O SWITCH
0241.000		293031680503		CINCH-BUCHSE 3-FACH FBAS/NF L,R	CINCH SOCKET 3 FOLD FBAS/AF L,R
0300.000		296319810901		GEH-RUECKTEIL OFB	CABINET REAR PART SURFACE TREATED
0320.000		291104626801		TYPENAUFLIEBER VNU	TYPE LABEL VNU
0700.000	△	092461317507		ENTMAGNETISIERUNGSSPULE M.HALTER	DEGAUSSING COIL W.HOLDER
0950.000		292104087100		SHIFTSTECKER KPL 4 W/120 OHM	SHIFT PLUG CPL 4 W/120 OHM
0950.000		292104087406		SHIFTSTECKER KPL 4W/220 OHM	SHIFT PLUG CPL 4W/220 OHM
1100.000		830003047400		BILDR.A66EAK554X44 31KV PHILIPS	PICT.TUBE A66EAK554X44 31KV PHILIPS
1200.000	△	292013601106		ANODENKAPPE M.HOCHSPANNUNGSKABEL	ANODE CAP W.HIGH VOLTAGE CABLE
2400.000		296420660300		TP 150 C FERNBEDIENUNG SCHWARZ	TP 150 C REMOTE CONTROL BLACK
2410.000		720086745000		DECKEL BATTERIE TP 150 C	BATTERY LID TP 150 C
		219219415300		BEDIENUNGSANLEITUNG D	OPERATING INSTRUCTIONS D
		219219415400		BEDIENUNGSANLEITUNG F/I	OPERATING INSTRUCTIONS F/I
		219219415500		BEDIENUNGSANLEITUNG GB/NL	OPERATING INSTRUCTIONS GB/NL
		219219415600		BEDIENUNGSANLEITUNG E/P	OPERATING INSTRUCTIONS E/P
		219219415700		BEDIENUNGSANLEITUNG DK/FIN	OPERATING INSTRUCTIONS DK/FIN
		219219415800		BEDIENUNGSANLEITUNG S/N	OPERATING INSTRUCTIONS S/N
		720100305000		SERVICE MANUAL D/GB	SERVICE MANUAL D/GB
		720100305400		SERVICE MANUAL D/GB 4.ERGAENZUNG	SERVICE MANUAL D/GB 4TH SUPPLEMENT
		720100305500		SERVICE MANUAL D/GB 5.ERGAENZUNG	SERVICE MANUAL D/GB 5TH SUPPLEMENT
		720100305600		SERVICE MANUAL D/GB 6.ERGAENZUNG	SERVICE MANUAL D/GB 6TH SUPPLEMENT
		297040195000	X	CHASSIS-FS-STEREO CUC 1837 DIDGI 100 KEIN E-TEIL	CHASSIS TV STEREO CUC 1837 DIDGI 100 NO SPARE PART
				X-SIEHE GESONDERTE E-LISTE	X-SEE SEPARATE PARTS LIST
				ALLE WEITEREN TEILE SIEHE E-LISTE SEDANCE 70 ST 70-284/8 DOLBY SCHWARZ MAT.-NR.: 921921027500 BESTELL-NR.: GCK6675 AUSGABE 1/2001 VERSION NR.: VNM	FOR ALL OTHER PARTS SEE SEDANCE 70 ST 70-284/8 DOLBY BLACK PART NO.: 921921027500 ORDER NR.: GCK6675 EDITION 1/2001 VERSION NO.: VNM

ÄNDERUNGEN VORBEHALTEN / SUBJECT TO ALTERATION

POS. NR. ABB. MATERIAL-NR. ANZ. BEZEICHNUNG  
POS. NO. FIG. PART NUMBER QTY. ①

DESCRIPTION  
②

## SEDANCE 70 ST 70-284/8 DOLBY

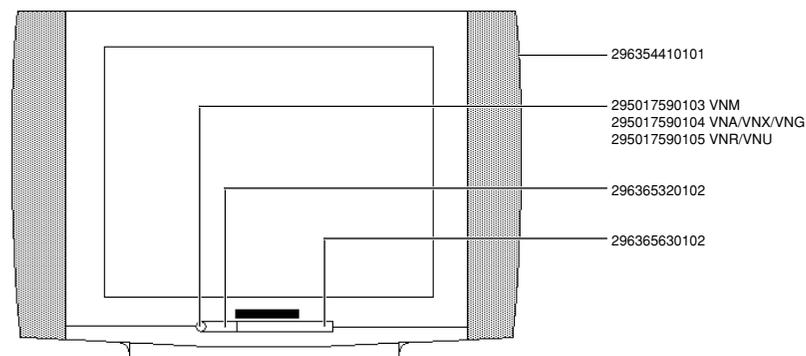

Es gelten die Vorschriften und Sicherheitshinweise gemäß dem Service Manual "Sicherheit", Mat.-Nummer 720108000000, sowie zusätzlich die eventuell abweichenden, landesspezifischen Vorschriften!



The regulations and safety instructions shall be valid as provided by the "Safety" Service Manual, part number 720108000000, as well as the respective national deviations.

ÄNDERUNGEN VORBEHALTEN / SUBJECT TO ALTERATION

Ersatzteilliste  
Spare Parts List

6 / 2002

**SEDANCE 70 ST 70-284/8 DOLBY**

MATERIAL-NR. / PART NO.: 921921029200 BESTELL-NR. / ORDER NO.: GCK6692 TITANE  
VERSION NR./VERSION NO.: VNM

POS. NR. POS. NO.	ABB. FIG.	MATERIAL-NR. PART NUMBER	ANZ. QTY.	BEZEICHNUNG D	DESCRIPTION GB
		921921029200		SEDANCE 70 ST 70-284/8 DOLBY TITANE KEIN E-TEIL	SEDANCE 70 ST 70-284/8 DOLBY TITANE NO SPARE PART
0050.000				PROGRAMM FLASH-EPROM DOWNLOAD: WWW.GRUNDIG.DE/ PRODUKTE/KONTAKT/HAENDLERSERVICE	PROGRAM FLASH EPROM DOWNLOAD: WWW.GRUNDIG.DE/ PRODUCTS/CONTACT/RESELLER SUPPORT
0215.000		295017590104		RAHMEN M.TASTENKNOPF NETZ KPL	FRAME W.KEY POWER CPL
0240.000		293033904200		KOPFHOERERBUCHSE 3,5 O.SCHALTER	HEADPHONE SOCKET 3.5 W/O SWITCH
0241.000		293031680503		CINCH-BUCHSE 3-FACH FBAS/NF L,R	CINCH SOCKET 3 FOLD FBAS/AF L,R
0320.000		291102156504		TYPENAUFKLEBER VNX 29KV PHILIPS-BR	TYPE LABEL VNX 29KV PHILIPS PT
0320.000		291102966503		TYPENAUFKLEBER VNX	TYPE LABEL VNX
0700.000	△	092461317506		<b>31KV PANASONIC-BR</b> ENTMAGNETISIERUNGSSPULE M.HALTER	<b>31KV PANASONIC PT</b> DEGAUSSING COIL W.HOLDER
0950.000		292104087100		SHIFTSTECKER KPL 4 W/120 OHM	SHIFT PLUG CPL 4 W/120 OHM
0950.000		292104087406		SHIFTSTECKER KPL 4W/220 OHM	SHIFT PLUG CPL 4W/220 OHM
1100.000	△	830003043600		BILDR.A66EAK075X44 <b>29KV PHILIPS</b>	PICT.TUBE A66EAK075X44 <b>29KV PHILIPS</b>
1100.000	△	830003048500		BILDR.A66ECF50X56 <b>31KV PANASONIC</b>	PICT.TUBE A66ECF50X56 <b>31KV PANASONIC</b>
2400.000		296420660300		TP 150 C FERNBEDIENUNG SCHWARZ	TP 150 C REMOTE CONTROL BLACK
2410.000		720086745000		DECKEL BATTERIE TP 150 C	BATTERY LID TP 150 C
				<b>FUER BILDR.A66EAK075X44 29KV PHILIPS</b> BEDIENUNGSANLEITUNG D BEDIENUNGSANLEITUNG F/I BEDIENUNGSANLEITUNG GB/NL BEDIENUNGSANLEITUNG E/P BEDIENUNGSANLEITUNG DK/FIN BEDIENUNGSANLEITUNG S/N	<b>FOR PICT.TUBE A66EAK075X44 29KV PHILIPS</b> OPERATING INSTRUCTIONS D OPERATING INSTRUCTIONS F/I OPERATING INSTRUCTIONS GB/NL OPERATING INSTRUCTIONS E/P OPERATING INSTRUCTIONS DK/FIN OPERATING INSTRUCTIONS S/N
		219219413900		BEDIENUNGSANLEITUNG D	OPERATING INSTRUCTIONS D
		219219414000		BEDIENUNGSANLEITUNG F/I	OPERATING INSTRUCTIONS F/I
		219219414100		BEDIENUNGSANLEITUNG GB/NL	OPERATING INSTRUCTIONS GB/NL
		219219414200		BEDIENUNGSANLEITUNG E/P	OPERATING INSTRUCTIONS E/P
		219219414300		BEDIENUNGSANLEITUNG DK/FIN	OPERATING INSTRUCTIONS DK/FIN
		219219414400		BEDIENUNGSANLEITUNG S/N	OPERATING INSTRUCTIONS S/N
				<b>FUER BILDR.A66ECF50X56 31KV PANASONIC</b> BEDIENUNGSANLEITUNG D BEDIENUNGSANLEITUNG F/I BEDIENUNGSANLEITUNG GB/NL BEDIENUNGSANLEITUNG E/P BEDIENUNGSANLEITUNG DK/FIN BEDIENUNGSANLEITUNG S/N	<b>FOR PICT.TUBE A66ECF50X56 31KV PANASONIC</b> OPERATING INSTRUCTIONS D OPERATING INSTRUCTIONS F/I OPERATING INSTRUCTIONS GB/NL OPERATING INSTRUCTIONS E/P OPERATING INSTRUCTIONS DK/FIN OPERATING INSTRUCTIONS S/N
		219219414600		BEDIENUNGSANLEITUNG D	OPERATING INSTRUCTIONS D
		219219414700		BEDIENUNGSANLEITUNG F/I	OPERATING INSTRUCTIONS F/I
		219219414800		BEDIENUNGSANLEITUNG GB/NL	OPERATING INSTRUCTIONS GB/NL
		219219414900		BEDIENUNGSANLEITUNG E/P	OPERATING INSTRUCTIONS E/P
		219219415000		BEDIENUNGSANLEITUNG DK/FIN	OPERATING INSTRUCTIONS DK/FIN
		219219415100		BEDIENUNGSANLEITUNG S/N	OPERATING INSTRUCTIONS S/N
		720100305000		SERVICE MANUAL D/GB	SERVICE MANUAL D/GB
		720100305400		SERVICE MANUAL D/GB 4.ERGAENZUNG	SERVICE MANUAL D/GB 4TH SUPPLEMENT
		720100305500		SERVICE MANUAL D/GB 5.ERGAENZUNG	SERVICE MANUAL D/GB 5TH SUPPLEMENT
		720100305600		SERVICE MANUAL D/GB 6.ERGAENZUNG	SERVICE MANUAL D/GB 6TH SUPPLEMENT
				ALLE WEITEREN TEILE SIEHE E-LISTE SEDANCE 70 ST 70-284/8 DOLBY TITANE MAT.-NR.: 921921029200 BESTELL-NR.: GCK6692 AUSGABE 1/2001 VERSION NR.: VNM	FOR ALL OTHER PARTS SEE SEDANCE 70 ST 70-284/8 DOLBY TITANE PART NO: 921921029200 ORDER NR: GCK6692 EDITION 1/2001 VERSION NO.: VNM

**SEDANCE 70 ST 70-284/8 DOLBY**

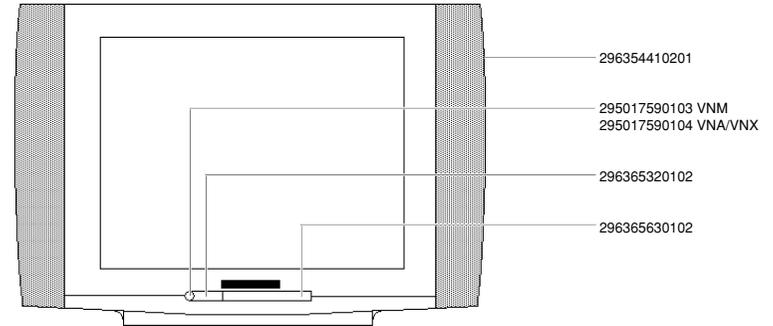

POS. NR. MATERIAL-NR. BEZEICHNUNG  
POS. NO. PART NUMBER DESCRIPTION

POS. NR. MATERIAL-NR. BEZEICHNUNG  
POS. NO. PART NUMBER DESCRIPTION

Es gelten die Vorschriften und Sicherheitshinweise gemäß dem Service Manual "Sicherheit", Mat.-Nummer 720108000000, sowie zusätzlich die eventuell abweichenden, landesspezifischen Vorschriften!



The regulations and safety instructions shall be valid as provided by the "Safety" Service Manual, part number 720108000000, as well as the respective national deviations.

ÄNDERUNGEN VORBEHALTEN / SUBJECT TO ALTERATION

ÄNDERUNGEN VORBEHALTEN / SUBJECT TO ALTERATION

## SEDANCE 70 ST 70-284/8 DOLBY

MATERIAL-NR. / PART NO.: 921921029200 BESTELL-NR. / ORDER NO.: GCK6692 TITANE  
VERSION NR./VERSION NO.: **VNG**

POS. NR. POS. NO.	ABB. FIG.	MATERIAL-NR. PART NUMBER	ANZ. QTY.	BEZEICHNUNG (D)	DESCRIPTION (GB)
		921921029200		SEDANCE 70 ST 70-284/8 DOLBY TITANE KEIN E-TEIL	SEDANCE 70 ST 70-284/8 DOLBY TITANE NO SPARE PART
0050.000				PROGRAMM FLASH-EPROM DOWNLOAD: WWW.GRUNDIG.DE/ PRODUKTE/KONTAKT/HAENDLERSERVICE	PROGRAM FLASH EPROM DOWNLOAD: WWW.GRUNDIG.DE/ PRODUCTS/CONTACT/RESELLER SUPPORT
0215.000		295017590104		RAHMEN M.TASTENKNOPF NETZ KPL	FRAME W.KEY POWER CPL
0240.000		293033904200		KOPFHOERERBUCHSE 3,5 O.SCHALTER	HEADPHONE SOCKET 3,5 W/O SWITCH
0241.000		293031680503		CINCH-BUCHSE 3-FACH FBAS/NF L,R	CINCH SOCKET 3 FOLD FBAS/AF L,R
0320.000		291104626601		TYPENAUFKLEBER VNG	TYPE LABEL VNG
0700.000	△	092461317506		ENTMAGNETISIERUNGSSPULE M.HALTER	DEGAUSSING COIL W.HOLDER
0950.000		292104087100		SHIFTSTECKER KPL 4 W/120 OHM	SHIFT PLUG CPL 4 W/120 OHM
0950.000		292104087406		SHIFTSTECKER KPL 4W/220 OHM	SHIFT PLUG CPL 4W/220 OHM
1100.000		830003047400		BILDR.A66EAK554X44 31KV PHILIPS	PICT.TUBE A66EAK554X44 31KV PHILIPS
1200.000	△	292013601106		ANODENKAPPE M.HOCHSPANNUNGSKABEL	ANODE CAP W.HIGH VOLTAGE CABLE
2400.000		296420660300		TP 100 C FERNBEDIENUNG SCHWARZ	TP 100 C REMOTE CONTROL BLACK
2410.000		720086745000		DECKEL BATTERIE TP 150 C	BATTERY LID TP 150 C
		219219415300		BEDIENUNGSANLEITUNG D	OPERATING INSTRUCTIONS D
		219219415400		BEDIENUNGSANLEITUNG F/I	OPERATING INSTRUCTIONS F/I
		219219415500		BEDIENUNGSANLEITUNG GB/NL	OPERATING INSTRUCTIONS GB/NL
		219219415600		BEDIENUNGSANLEITUNG E/P	OPERATING INSTRUCTIONS E/P
		219219415700		BEDIENUNGSANLEITUNG DK/FIN	OPERATING INSTRUCTIONS DK/FIN
		219219415800		BEDIENUNGSANLEITUNG S/N	OPERATING INSTRUCTIONS S/N
		720100305000		SERVICE MANUAL D/GB	SERVICE MANUAL D/GB
		720100305400		SERVICE MANUAL D/GB 4.ERGAENZUNG	SERVICE MANUAL D/GB 4TH SUPPLEMENT
		720100305500		SERVICE MANUAL D/GB 5.ERGAENZUNG	SERVICE MANUAL D/GB 5TH SUPPLEMENT
		720100305600		SERVICE MANUAL D/GB 6.ERGAENZUNG	SERVICE MANUAL D/GB 6TH SUPPLEMENT
		297040111500	X	CHASSIS-FS-STEREO CUC 1837 DIDGI 100 KEIN E-TEIL	CHASSIS TV STEREO CUC 1837 DIDGI 100 NO SPARE PART
				X=SIEHE GESONDERTE E-LISTE	X=SEE SEPARATE PARTS LIST
				ALLE WEITEREN TEILE SIEHE E-LISTE SEDANCE 70 ST 70-284/8 DOLBY TITANE MAT.-NR.: 921921029200 BESTELL-NR.: GCK6692 AUSGABE 1/2001 VERSION NR.: <b>VNM</b>	FOR ALL OTHER PARTS SEE SEDANCE 70 ST 70-284/8 DOLBY TITANE PART NO.: 921921029200 ORDER NR.: GCK6692 EDITION 1/2001 VERSION NO.: <b>VNM</b>

POS. NR. MATERIAL-NR. BEZEICHNUNG  
POS. NO. PART NUMBER DESCRIPTION

POS. NR. MATERIAL-NR. BEZEICHNUNG  
POS. NO. PART NUMBER DESCRIPTION

## SEDANCE 70 ST 70-284/8 DOLBY

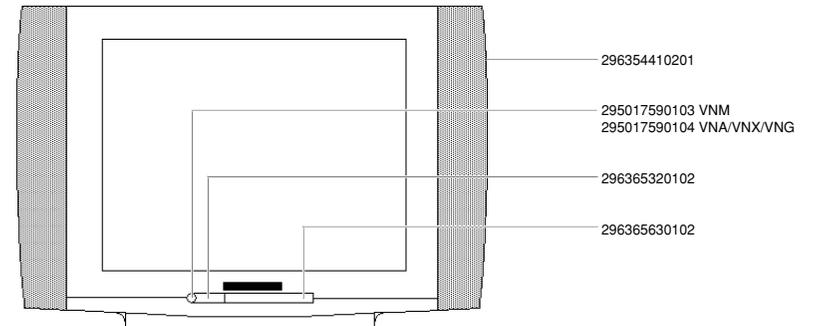

Es gelten die Vorschriften und Sicherheitshinweise gemäß dem Service Manual "Sicherheit", Mat.-Nummer 720108000000, sowie zusätzlich die eventuell abweichenden, landesspezifischen Vorschriften!



The regulations and safety instructions shall be valid as provided by the "Safety" Service Manual, part number 720108000000, as well as the respective national deviations.

Ersatzteilliste  
Spare Parts List

6 / 2002

**SEDANCE 70 ST 70-284/8 DOLBY**

MATERIAL-NR. / PART NO.: 921921029200 BESTELL-NR. / ORDER NO.: GCK6692 TITANE  
VERSION NR./VERSION NO.: VNR

POS. NR. POS. NO.	ABB. FIG.	MATERIAL-NR. PART NUMBER	ANZ. QTY.	BEZEICHNUNG (D)	DESCRIPTION (GB)
		921921029200		SEDANCE 70 ST 70-284/8 DOLBY TITANE KEIN E-TEIL	SEDANCE 70 ST 70-284/8 DOLBY TITANE NO SPARE PART
0050.000				PROGRAMM FLASH-EPROM DOWNLOAD: WWW.GRUNDIG.DE/ PRODUKTE/KONTAKT/HAENDLERSERVICE	PROGRAM FLASH EPROM DOWNLOAD: WWW.GRUNDIG.DE/ PRODUCTS/CONTACT/RESELLER SUPPORT
0215.000		295017590105		RAHMEN M.TASTENKNOPF NETZ KPL	FRAME W.KEY POWER CPL
0240.000		293033904200		KOPFHOERERBUCHSE 3,5 O.SCHALTER	HEADPHONE SOCKET 3.5 W/O SWITCH
0241.000		293031680503		CINCH-BUCHSE 3-FACH FBAS/NF L,R	CINCH SOCKET 3 FOLD FBAS/AF L,R
0300.000		296319810801		GEH-RUECKTEIL OFB	CABINET REAR PART SURFACE TREATED
0320.000		291102156704		TYPENAUFKLEBER VNR 29KV PHILIPS-BR	TYPE LABEL VNR 29KV PHILIPS PT
0320.000		291102966703		TYPENAUFKLEBER VNR 31KV <b>PANASONIC-BR</b>	TYPE LABEL VNR 31KV <b>PANASONIC PT</b>
0700.000	△	092461317507		ENTMAGNETISIERUNGSSPULE M.HALTER	DEGAUSSING COIL W.HOLDER
0950.000		292104087100		SHIFTSTECKER KPL 4 W/120 OHM	SHIFT PLUG CPL 4 W/120 OHM
0950.000		292104087406		SHIFTSTECKER KPL 4W/220 OHM	SHIFT PLUG CPL 4W/220 OHM
1100.000	△	830003043600		BILDR.A66EAK075X44 <b>29KV PHILIPS</b>	PICT.TUBE A66EAK075X44 <b>29KV PHILIPS</b>
1100.000	△	830003048500		BILDR.A66ECF50X56 <b>31KV PANASONIC</b>	PICT.TUBE A66ECF50X56 <b>31KV PANASONIC</b>
2400.000		296420660300		TP 150 C FERNBEDIENUNG SCHWARZ	TP 150 C REMOTE CONTROL BLACK
2410.000		720086745000		DECKEL BATTERIE TP 150 C	BATTERY LID TP 150 C
219219413900				<b>FUER BILDR.A66EAK075X44 29KV PHILIPS</b>	<b>FOR PICT.TUBE A66EAK075X44 29KV PHILIPS</b>
219219414000				BEDIENUNGSANLEITUNG D	OPERATING INSTRUCTIONS D
219219414100				BEDIENUNGSANLEITUNG F/I	OPERATING INSTRUCTIONS F/I
219219414200				BEDIENUNGSANLEITUNG GB/NL	OPERATING INSTRUCTIONS GB/NL
219219414300				BEDIENUNGSANLEITUNG E/P	OPERATING INSTRUCTIONS E/P
219219414400				BEDIENUNGSANLEITUNG DK/FIN	OPERATING INSTRUCTIONS DK/FIN
				BEDIENUNGSANLEITUNG S/N	OPERATING INSTRUCTIONS S/N
219219414600				<b>FUER BILDR.A66ECF50X56 31KV PANASONIC</b>	<b>FOR PICT.TUBE A66ECF50X56 31KV PANASONIC</b>
219219414700				BEDIENUNGSANLEITUNG D	OPERATING INSTRUCTIONS D
219219414800				BEDIENUNGSANLEITUNG F/I	OPERATING INSTRUCTIONS F/I
219219414900				BEDIENUNGSANLEITUNG GB/NL	OPERATING INSTRUCTIONS GB/NL
219219415000				BEDIENUNGSANLEITUNG E/P	OPERATING INSTRUCTIONS E/P
219219415100				BEDIENUNGSANLEITUNG DK/FIN	OPERATING INSTRUCTIONS DK/FIN
				BEDIENUNGSANLEITUNG S/N	OPERATING INSTRUCTIONS S/N
720100305000				SERVICE MANUAL D/GB	SERVICE MANUAL D/GB
720100305400				SERVICE MANUAL D/GB 4.ERGAENZUNG	SERVICE MANUAL D/GB 4TH SUPPLEMENT
720100305500				SERVICE MANUAL D/GB 5.ERGAENZUNG	SERVICE MANUAL D/GB 5TH SUPPLEMENT
720100305600				SERVICE MANUAL D/GB 6.ERGAENZUNG	SERVICE MANUAL D/GB 6TH SUPPLEMENT
297040190900	X			CHASSIS-FS-STEREO <b>29KV PHILIPS-BR</b> CUC 1837 DIDGI 100 KEIN E-TEIL	CHASSIS TV STEREO <b>29KV PHILIPS PT</b> CUC 1837 DIDGI 100 NO SPARE PART
297040194900	X			CHASSIS-FS-STEREO <b>31KV PANASONIC-BR</b> CUC 1837 DIDGI 100 KEIN E-TEIL	CHASSIS TV STEREO <b>31KV PANASONIC PT</b> CUC 1837 DIDGI 100 NO SPARE PART
				X=SIHGE GESONDERTE E-LISTE	X=SEE SEPARATE PARTS LIST

ÄNDERUNGEN VORBEHALTEN / SUBJECT TO ALTERATION

POS. NR. POS. NO.	ABB. FIG.	MATERIAL-NR. PART NUMBER	ANZ. QTY.	BEZEICHNUNG (D)	DESCRIPTION (GB)
----------------------	--------------	-----------------------------	--------------	--------------------	---------------------

ALLE WEITEREN TEILE SIEHE E-LISTE  
SEDANCE 70 ST 70-284/8 DOLBY TITANE  
MAT.-NR.: 921921029200  
BESTELL-NR.: GCK6692  
AUSGABE 1/2001  
VERSION NR.: VNM

FOR ALL OTHER PARTS SEE  
SEDANCE 70 ST 70-284/8 DOLBY TITANE  
PART NO: 921921029200  
ORDER NR: GCK6692  
EDITION 1/2001  
VERSION NO.: VNM

**SEDANCE 70 ST 70-284/8 DOLBY**

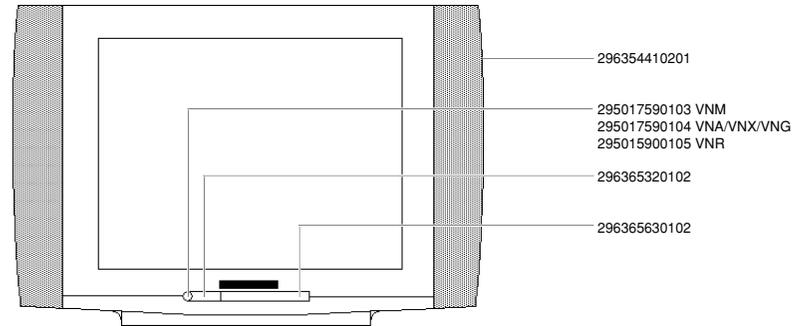

Es gelten die Vorschriften und Sicherheitshinweise gemäß dem Service Manual "Sicherheit", Mat.-Nummer 720108000000, sowie zusätzlich die eventuell abweichenden, landesspezifischen Vorschriften!



The regulations and safety instructions shall be valid as provided by the "Safety" Service Manual, part number 720108000000, as well as the respective national deviations.

ÄNDERUNGEN VORBEHALTEN / SUBJECT TO ALTERATION

MATERIAL-NR. / PART NO.: 921921029200 BESTELL-NR. / ORDER NO.: GCK6692 TITANE  
VERSION NR./VERSION NO.: **VNU**

POS. NR. POS. NO.	ABB. FIG.	MATERIAL-NR. PART NUMBER	ANZ. QTY.	BEZEICHNUNG <b>(D)</b>	DESCRIPTION <b>(GB)</b>
		921921029200		SEDANCE 70 ST 70-284/8 DOLBY TITANE KEIN E-TEIL	SEDANCE 70 ST 70-284/8 DOLBY TITANE NO SPARE PART
0050.000				PROGRAMM FLASH-EPROM DOWNLOAD: WWW.GRUNDIG.DE/ PRODUKTE/KONTAKT/HAENDLERSERVICE	PROGRAM FLASH EPROM DOWNLOAD: WWW.GRUNDIG.DE/ PRODUCTS/CONTACT/RESELLER SUPPORT
0215.000		295017590105		RAHMEN M.TASTENKNOPF NETZ KPL	FRAME W.KEY POWER CPL
0240.000		293033904200		KOPFHOERERBUCHSE 3,5 O.SCHALTER	HEADPHONE SOCKET 3.5 W/O SWITCH
0241.000		293031680503		CINCH-BUCHSE 3-FACH FBAS/NF L,R	CINCH SOCKET 3 FOLD FBAS/AF L,R
0300.000		296319810801		GEH-RUECKTEIL OFB	CABINET REAR PART SURFACE TREATED
0320.000		291104626801		TYPENAUFKLEBER VNU	TYPE LABEL VNU
0700.000	△	092461317507		ENTMAGNETISIERUNGSSPULE M.HALTER	DEGAUSSING COIL W.HOLDER
0950.000		292104087100		SHIFTSTECKER KPL 4 W/120 OHM	SHIFT PLUG CPL 4 W/120 OHM
0950.000		292104087406		SHIFTSTECKER KPL 4W/220 OHM	SHIFT PLUG CPL 4W/220 OHM
1100.000		830003047400		BILDR.A66EAK554X44 31KV PHILIPS	PICT.TUBE A66EAK554X44 31KV PHILIPS
1200.000	△	292013601106		ANODENKAPPE M.HOCHSPANNUNGSKABEL	ANODE CAP W.HIGH VOLTAGE CABLE
2400.000		296420660300		TP 150 C FERNBEDIENUNG SCHWARZ	TP 150 C REMOTE CONTROL BLACK
2410.000		720086745000		DECKEL BATTERIE TP 150 C	BATTERY LID TP 150 C
219219415300				BEDIENUNGSANLEITUNG D	OPERATING INSTRUCTIONS D
219219415400				BEDIENUNGSANLEITUNG F/I	OPERATING INSTRUCTIONS F/I
219219415500				BEDIENUNGSANLEITUNG GB/NL	OPERATING INSTRUCTIONS GB/NL
219219415600				BEDIENUNGSANLEITUNG E/P	OPERATING INSTRUCTIONS E/P
219219415700				BEDIENUNGSANLEITUNG DK/FIN	OPERATING INSTRUCTIONS DK/FIN
219219415800				BEDIENUNGSANLEITUNG S/N	OPERATING INSTRUCTIONS S/N
720100305000				SERVICE MANUAL D/GB	SERVICE MANUAL D/GB
720100305400				SERVICE MANUAL D/GB 4.ERGAENZUNG	SERVICE MANUAL D/GB 4TH SUPPLEMENT
720100305500				SERVICE MANUAL D/GB 5.ERGAENZUNG	SERVICE MANUAL D/GB 5TH SUPPLEMENT
720100305600				SERVICE MANUAL D/GB 6.ERGAENZUNG	SERVICE MANUAL D/GB 6TH SUPPLEMENT
297040195000	X			CHASSIS-FS-STEREO CUC 1837 DIDGI 100 KEIN E-TEIL	CHASSIS TV STEREO CUC 1837 DIDGI 100 NO SPARE PART
				X-SIEHE GESONDERTE E-LISTE	X=SEE SEPARATE PARTS LIST
				ALLE WEITEREN TEILE SIEHE E-LISTE SEDANCE 70 ST 70-284/8 DOLBY TITANE MAT.-NR.: 921921029200 BESTELL-NR.: GCK6692 AUSGABE 1/2001 VERSION NR.: <b>VNM</b>	FOR ALL OTHER PARTS SEE SEDANCE 70 ST 70-284/8 DOLBY TITANE PART NO.: 921921029200 ORDER NR.: GCK6692 EDITION 1/2001 VERSION NO.: <b>VNM</b>

POS. NR. POS. NO.	ABB. FIG.	MATERIAL-NR. PART NUMBER	ANZ. QTY.	BEZEICHNUNG <b>(D)</b>	DESCRIPTION <b>(GB)</b>
----------------------	--------------	-----------------------------	--------------	---------------------------	----------------------------

### SEDANCE 70 ST 70-284/8 DOLBY

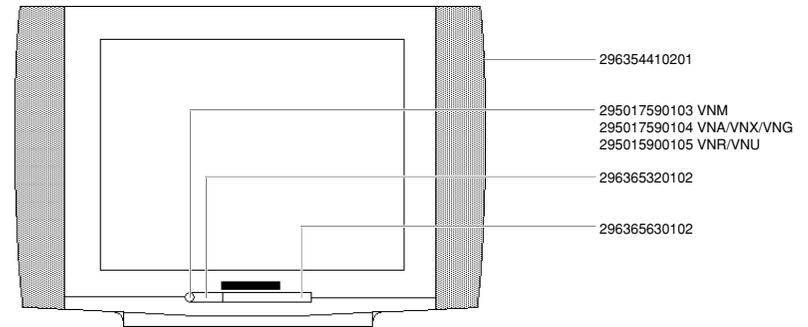

Es gelten die Vorschriften und Sicherheitshinweise gemäß dem Service Manual "Sicherheit", Mat.-Nummer 720108000000, sowie zusätzlich die eventuell abweichenden, landesspezifischen Vorschriften!



The regulations and safety instructions shall be valid as provided by the "Safety" Service Manual, part number 720108000000, as well as the respective national deviations.

Ersatzteilliste  
Spare Parts List

**6 / 2002**

**DAVIO 70 ST 70-292 DOLBY**

MATERIAL-NR. / PART NO.: 921851017200 BESTELL-NR. / ORDER NO.: GCI8572 AGANA-GRAU/AGANA GREY  
VERSION NR./VERSION NO.: VNA

POS. NR. POS. NO.	ABB. FIG.	MATERIAL-NR. PART NUMBER	ANZ. QTY.	BEZEICHNUNG D	DESCRIPTION GB
		921851017200		DAVIO 70 ST 70-292 DOLBY AGANA-GRAU KEIN E-TEIL	DAVIO 70 ST 70-292 DOLBY AGANA GREY NO SPARE PART
0050.000				PROGRAMM FLASH-EPROM DOWNLOAD: WWW.GRUNDIG.DE/PRODUKTE/ KONTAKT/HAENDLERSERVICE	PROGRAM FLASH-EPROM DOWNLOAD: WWW.GRUNDIG.DE/PRODUCTS/ CONTACT/RESELLER SUPPORT
0215.000		296366440103		RAHMEN	FRAME
0218.000		295016880207		NETZTASTENKNOPF	KNOB KEY POWER
0320.000		291102986405		TYPENAUFKLEBER VNA	TYPE LABEL SELF ADHESIVE VNA
WW.		291105216401		TYPENAUFKLEBER VNA	TYPE LABEL SELF ADHESIVE VNA
0450.000		297006544101		HALTER LEITERPLATTE	HOLDER PCB
0700.000	△	092461317601		ENTMAGNETISIERUNGSSPULE	DEGAUSSING COIL
0950.000		292104087100		SHIFTSTECKER KPL 4W/120	OHM SHIFT PLUG CPL 4W/120 OHM
0950.000		292104087406		SHIFTSTECKER KPL 4W/220 OHM	SHIFT PLUG CPL 4W/220 OHM
2400.000		296420660300		TP 150 C FERNBEDIENUNG	TP 150 C REMOTE CONTROL
2410.000		720086745000		DECKEL BATTERIE	BATTERY LID
		218519412000		BEDIENUNGSANLEITUNG D	OPERATION INSTRUCTIONS D
		218519412100		BEDIENUNGSANLEITUNG F/I	OPERATION INSTRUCTIONS F/I
		218519412200		BEDIENUNGSANLEITUNG GB/NL	OPERATION INSTRUCTIONS GB/NL
		720100305000		SERVICE MANUAL D/GB	SERVICE MANUAL D/GB
		720100305400		SERVICE MANUAL D/GB 4.ERGAENZUNG	SERVICE MANUAL D/GB 4TH SUPPLEMENT
		720100305500		SERVICE MANUAL D/GB 5.ERGAENZUNG	SERVICE MANUAL D/GB 5TH SUPPLEMENT
		720100305600		SERVICE MANUAL D/GB 6.ERGAENZUNG	SERVICE MANUAL D/GB 6TH SUPPLEMENT
		296560044300		MONTAGEZUBEHOER F.BILDROHR KEIN E-TEIL	MOUNTING ACCESSORIES F.PICT.TUBE NO SPARE PART
				WW. = WAHLWEISE	WW. = OPTIONAL
				ALLE ANDEREN TEILE SIEHE E-LISTE DAVIO 70 ST 70-292 DOLBY MAT.-NR: 921851017200 BESTELL-NR: AUSGABE 12/2000 VERSION-NR.: VNM	FOR ALL OTHER PARTS SEE DAVIO 70 ST 70-292 DOLBY PART NO: 921851017200 ORDER NO: EDITION 12/2000 VERSION NO.: VNM

ÄNDERUNGEN VORBEHALTEN / SUBJECT TO ALTERATION

POS. NR. MATERIAL-NR. BEZEICHNUNG  
POS. NO. PART NUMBER DESCRIPTION

POS. NR. MATERIAL-NR. BEZEICHNUNG  
POS. NO. PART NUMBER DESCRIPTION

**DAVIO 70 ST 70-292 DOLBY**

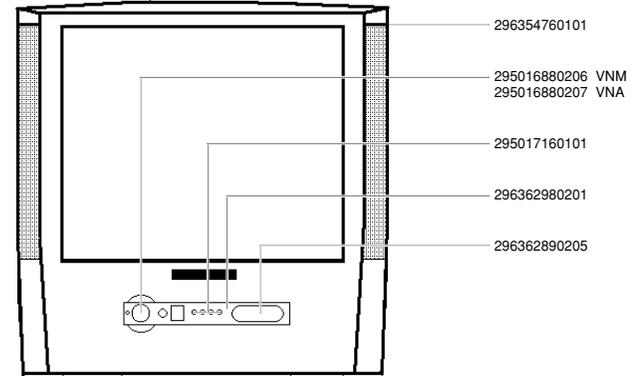

Es gelten die Vorschriften und Sicherheitshinweise gemäß dem Service Manual "Sicherheit", Mat.-Nummer 720108000000, sowie zusätzlich die eventuell abweichenden, landesspezifischen Vorschriften!



The regulations and safety instructions shall be valid as provided by the "Safety" Service Manual, part number 720108000000, as well as the respective national deviations.

ÄNDERUNGEN VORBEHALTEN / SUBJECT TO ALTERATION

## Ersatzteilliste Spare Parts List

### 6 / 2002

### DAVIO 70 ST 70-292 DOLBY

MATERIAL-NR. / PART NO.: 921851017200 BESTELL-NR. / ORDER NO.: GCI8572 AGANA-GRAU/AGANA GREY  
VERSION NR./VERSION NO.: VNX

POS. NR. POS. NO.	ABB. FIG.	MATERIAL-NR. PART NUMBER	ANZ. QTY.	BEZEICHNUNG (D)	DESCRIPTION (GB)
		921851017200		DAVIO 70 ST 70-292 DOLBY AGANA-GRAU VNX KEIN E-TEIL	DAVIO 70 ST 70-292 DOLBY AGANA GREY VNX NO SPARE PART
0050.000				PROGRAMM FLASH-EPROM DOWNLOAD: WWW.GRUNDIG.DE/PRODUKTE/ KONTAKT/HAENDLERSERVICE	PROGRAM FLASH-EPROM DOWNLOAD: WWW.GRUNDIG.DE/PRODUCTS/ CONTACT/RESELLER SUPPORT
0215.000		296366440104		RAHMEN	FRAME
0218.000		295016880207		NETZTASTENKNOPF	KNOB KEY POWER
0320.000		291102986505		TYPENAUFKLEBER VNX	TYPE LABEL SELF ADHESIVE VNX
WW.		291105216501		TYPENAUFKLEBER VNX	TYPE LABEL SELF ADHESIVE VNX
0450.000		297006544101		HALTER LEITERPLATTE	HOLDER PCB
0700.000	△	092461317601		ENTMAGNETISIERUNGSSPULE	DEGAUSSING COIL
0950.000		292104087100		SHIFTSTECKER KPL 4W/120 OHM	SHIFT PLUG CPL 4W/120 OHM
0950.000		292104087406		SHIFTSTECKER KPL 4W/220 OHM	SHIFT PLUG CPL 4W/220 OHM
2400.000		296420660300		TP 150 C FERNBEDIENUNG	TP 150 C REMOTE CONTROL
2410.000		720086745000		DECKEL BATTERIE	BATTERY LID
		218519412000		BEDIENUNGSANLEITUNG D	OPERATION INSTRUCTIONS D
		218519412100		BEDIENUNGSANLEITUNG F/I	OPERATION INSTRUCTIONS F/I
		218519412200		BEDIENUNGSANLEITUNG GB/NL	OPERATION INSTRUCTIONS GB/NL
		720100305000		SERVICE MANUAL D/GB	SERVICE MANUAL D/GB
		720100305400		SERVICE MANUAL D/GB 4.ERG	SERVICE MANUAL D/GB 4TH SUPPLEMENT
		720100305500		SERVICE MANUAL D/GB 5.ERG	SERVICE MANUAL D/GB 5TH SUPPLEMENT
		720100305600		SERVICE MANUAL D/GB 6.ERG	SERVICE MANUAL D/GB 6TH SUPPLEMENT
		297040190800	X	CHASSIS-FS-STEREO DIGI 100 CUC 1837 KEIN E-TEIL	CHASSIS TV STEREO DIGI 100 CUC 1837 NO SPARE PART
				X = SIEHE GESONDERTE E-LISTE WW. = WAHLWEISE	X = SEE SEPARATE PARTS LIST WW. = OPTIONAL
				ALLE ANDEREN TEILE SIEHE E-LISTE DAVIO 70 ST 70-292 DOLBY MAT.-NR.: 921851017200 BESTELL-NR. AUSGABE 12/2000 VERSION-NR.: VNM	FOR ALL OTHER PARTS SEE DAVIO 70 ST 70-292 DOLBY PART NO.: 921851017200 ORDER NO. EDITION 12/2000 VERSION NO.: VNM

ÄNDERUNGEN VORBEHALTEN / SUBJECT TO ALTERATION

POS. NR. MATERIAL-NR. BEZEICHNUNG  
POS. NO. PART NUMBER DESCRIPTION

POS. NR. MATERIAL-NR. BEZEICHNUNG  
POS. NO. PART NUMBER DESCRIPTION

### DAVIO 70 ST 70-292 DOLBY

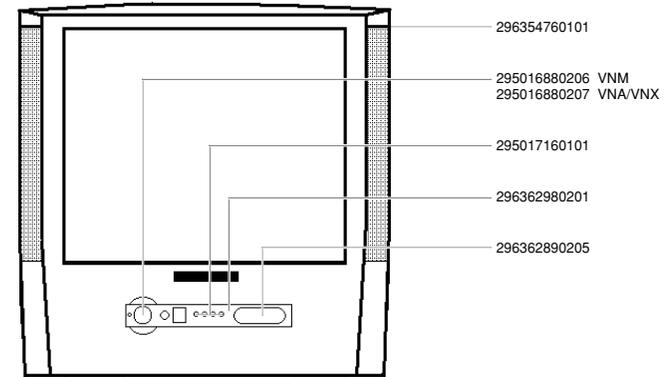

Es gelten die Vorschriften und Sicherheitshinweise gemäß dem Service Manual "Sicherheit", Mat.-Nummer 720108000000, sowie zusätzlich die eventuell abweichenden, landesspezifischen Vorschriften!



The regulations and safety instructions shall be valid as provided by the "Safety" Service Manual, part number 720108000000, as well as the respective national deviations.

ÄNDERUNGEN VORBEHALTEN / SUBJECT TO ALTERATION

### Ersatzteilliste Spare Parts List

6 / 2002

### DAVIO 70 ST 70-292/8 DOLBY

MATERIAL-NR. / PART NO.: 921851025200 BESTELL-NR. / ORDER NO.: GCI8452 POLAR  
VERSION NR./VERSION NO.: VNA

POS. NR. POS. NO.	ABB. FIG.	MATERIAL-NR. PART NUMBER	ANZ. QTY.	BEZEICHNUNG (D)	DESCRIPTION (GB)
		921851025200		DAVIO 70 ST 70-292/8 DOLBY POLAR KEIN E-TEIL	DAVIO 70 ST 70-292/8 DOLBY POLAR NO SPARE PART
0050.000				PROGRAMM FLASH-EPROM DOWNLOAD: WWW.GRUNDIG.DE/PRODUKTE/ KONTAKT/HAENDLERSERVICE	PROGRAMM FLASH-EPROM DOWNLOAD: WWW.GRUNDIG.DE/PRODUCTS/ CONTACT/RESELLER SUPPORT
0215.000		296366440103		RAHMEN	FRAME
0218.000		295016880207		NETZTASTENKNOPF	KNOB KEY POWER
0220.000		296366450102		VERLAENGERUNG NETZTASTE	EXTENSION KNOB KEY POWER
0320.000		291102996406		TYPENAUFKLEBER VNA	TYPE LABEL SELF ADHESIVE VNA
WW.		291105226401		TYPENAUFKLEBER VNA	TYPE LABEL SELF ADHESIVE VNA
0450.000		297006544101		HALTER LEITERPLATTE	HOLDER PCB
0700.000	△	092461317601		ENTMAGNETISIERUNGSSPULE	DEGAUSSING COIL
0950.000		292104087100		SHIFTSTECKER KPL 4W/120 OHM	SHIFT PLUG CPL 4W/120 OHM
0950.000		292104087406		SHIFTSTECKER KPL 4W/220 OHM	SHIFT PLUG CPL 4W/220 OHM
1395.000		296366440102		RAHMEN	FRAME
2400.000		296420660400		TP 150 C FERNBEDIENUNG	TP 150 C REMOTE CONTROL
2410.000		720086745100		DECKEL BATTERIE	BATTERY LID
		218519411300		BEDIENUNGSANLEITUNG D	OPERATION INSTRUCTIONS D
		218519411400		BEDIENUNGSANLEITUNG F/I	OPERATION INSTRUCTIONS F/I
		218519411500		BEDIENUNGSANLEITUNG GB/NL	OPERATION INSTRUCTIONS GB/NL
		218519411600		BEDIENUNGSANLEITUNG E/P	OPERATION INSTRUCTIONS E/P
		218519411700		BEDIENUNGSANLEITUNG DK/FIN	OPERATION INSTRUCTIONS DK/FIN
		218519411800		BEDIENUNGSANLEITUNG S/N	OPERATION INSTRUCTIONS S/N
		720100305000		SERVICE MANUAL D/GB	SERVICE MANUAL D/GB
		720100305400		SERVICE MANUAL D/GB 4.ERGAENZUNG	SERVICE MANUAL D/GB 4TH SUPPLEMENT
		720100305500		SERVICE MANUAL D/GB 5.ERGAENZUNG	SERVICE MANUAL D/GB 5TH SUPPLEMENT
		720100305600		SERVICE MANUAL D/GB 6.ERGAENZUNG	SERVICE MANUAL D/GB 6TH SUPPLEMENT
		296560044300		MONTAGEZUBEHOER F.BILDROHR KEIN E-TEIL	MOUNTING ACCESSORIES F.PICTURE TUBE NO SPARE PART
				WW. = WAHLWEISE	WW. = OPTIONAL
				ALLE ANDEREN TEILE SIEHE E-LISTE DAVIO 70 ST 70-292/8 DOLBY MAT.-NR.: 921851025200 BESTELL-NR.: GCI8452 AUSGABE 12/2000 VERSION-NR.: VNM	FOR ALL OTHER PARTS SEE DAVIO 70 ST 70-292/8 DOLBY PART NO.: 921851025200 ORDER NO.: GCI8452 EDITION 12/2000 VERSION NO.: VNM

POS. NR. MATERIAL-NR. BEZEICHNUNG  
POS. NO. PART NUMBER DESCRIPTION

POS. NR. MATERIAL-NR. BEZEICHNUNG  
POS. NO. PART NUMBER DESCRIPTION

### DAVIO 70 ST 70-292/8 DOLBY

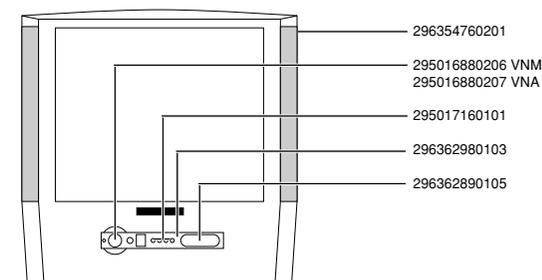

Es gelten die Vorschriften und Sicherheitshinweise gemäß dem Service Manual "Sicherheit", Mat.-Nummer 720108000000, sowie zusätzlich die eventuell abweichenden, landesspezifischen Vorschriften!



The regulations and safety instructions shall be valid as provided by the "Safety" Service Manual, part number 720108000000, as well as the respective national deviations.

# Ersatzteilliste Spare Parts List

## 6 / 2002

# GRUNDIG

## TV

### DAVIO 70 ST 70-292/8 DOLBY

MATERIAL-NR. / PART NO.: 921851025200 BESTELL-NR. / ORDER NO.: GCi8452 POLAR  
VERSION NR./VERSION NO.: VNX

POS. NR. POS. NO.	ABB. FIG.	MATERIAL-NR. PART NUMBER	ANZ. QTY.	BEZEICHNUNG <b>(D)</b>	DESCRIPTION <b>(GB)</b>
		921851025200		DAVIO 70 ST 70-292/8 DOLBY POLAR KEIN E-TEIL	DAVIO 70 ST 70-292/8 DOLBY POLAR NO SPARE PART
0050.000				PROGRAMM FLASH-EPROM DOWNLOAD: WWW.GRUNDIG.DE/PRODUKTE/ KONTAKT/HAENDLERSERVICE	PROGRAM FLASH-EPROM DOWNLOAD: WWW.GRUNDIG.DE/PRODUCTS/ CONTACT/RESELLER SUPPORT
0215.000		296366440104		RAHMEN	FRAME
0218.000		295016880207		NETZTASTENKNOPF	KNOB KEY POWER
0220.000		296366450102		VERLAENGERUNG NETZTASTE	EXTENSION KNOB KEY POWER
WW.		291102996506		TYPENAUFKLEBER VNX	TYPE LABEL VNX
0320.000		291105226501		TYPENAUFKLEBER VNX	TYPE LABEL VNX
0450.000		297006544101		HALTER LEITERPLATTE	HOLDER PCB
0700.000	△	092461317601		ENTMAGNETISIERUNGSSPULE	DEGAUSSING COIL
0950.000		292104087100		SHIFTSTECKER KPL 4W/120 OHM	SHIFT PLUG CPL 4W/120 OHM
0950.000		292104087406		SHIFTSTECKER KPL 4W/220 OHM	SHIFT PLUG CPL 4W/220 OHM
2400.000		296420660400		TP 150 C FERNBEDIENUNG	TP 150 C REMOTE CONTROL
2410.000		720086745100		DECKEL BATTERIE TP 150 C	BATTERY LID TP 150 C GREY
		218519411300		BEDIENUNGSANLEITUNG D	OPERATION INSTRUCTIONS D
		218519411400		BEDIENUNGSANLEITUNG F/I	OPERATION INSTRUCTIONS F/I
		218519411500		BEDIENUNGSANLEITUNG GB/NL	OPERATION INSTRUCTIONS GB/NL
		218519411600		BEDIENUNGSANLEITUNG E/P	OPERATION INSTRUCTIONS E/P
		218519411700		BEDIENUNGSANLEITUNG DK/FIN	OPERATION INSTRUCTIONS DK/FIN
		218519411800		BEDIENUNGSANLEITUNG S/N	OPERATION INSTRUCTIONS S/N
		720100305000		SERVICE MANUAL D/GB	SERVICE MANUAL D/GB
		720100305400		SERVICE MANUAL D/GB 4.ERGAENZUNG	SERVICE MANUAL D/GB 4TH SUPPLEMENT
		720100305500		SERVICE MANUAL D/GB 5.ERGAENZUNG	SERVICE MANUAL D/GB 5TH SUPPLEMENT
		720100305600		SERVICE MANUAL D/GB 6.ERGAENZUNG	SERVICE MANUAL D/GB 6TH SUPPLEMENT
		296560044300		MONTAGEZUBEHOER F.BILDROHR KEIN E-TEIL	MOUNTING ACCESSORIES F.PICT. TUBE NO SPARE PART
		297040190900	X	CHASSIS-FS-STEREO DIGI 100 CUC 1837 KEIN E-TEIL	CHASSIS TV STEREO DIGI 100 CUC 1837 NO SPARE PART
				X = SIEHE GESONDERTE E-LISTE WW. = WAHLWEISE	X = SEE SEPARATE PARTS LIST WW. = OPTIONAL
				ALLE ANDEREN TEILE SIEHE E-LISTE DAVIO 70 ST 70-292/8 DOLBY MAT.-NR.: 921851025200 BESTELL-NR.: GCi8452 AUSGABE 12/2000 VERSION-NR.: VNM	FOR ALL OTHER PARTS SEE DAVIO 70 ST 70-292/8 DOLBY PART NO.: 921851025200 ORDER NO.: GCi8452 EDITION 12/2000 VERSION NO.: VNM

### DAVIO 70 ST 70-292/8 DOLBY

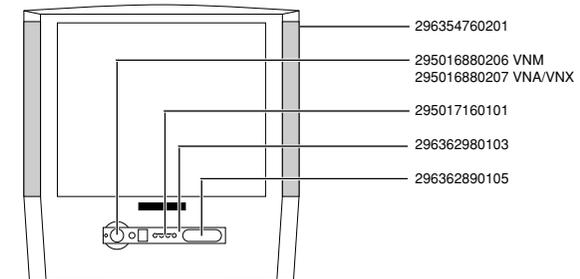

POS. NR. MATERIAL-NR. BEZEICHNUNG  
POS. NO. PART NUMBER DESCRIPTION

POS. NR. MATERIAL-NR. BEZEICHNUNG  
POS. NO. PART NUMBER DESCRIPTION

Es gelten die Vorschriften und Sicherheitshinweise gemäß dem Service Manual "Sicherheit", Mat.-Nummer 720108000000, sowie zusätzlich die eventuell abweichenden, landesspezifischen Vorschriften!



The regulations and safety instructions shall be valid as provided by the "Safety" Service Manual, part number 720108000000, as well as the respective national deviations.

ÄNDERUNGEN VORBEHALTEN / SUBJECT TO ALTERATION

ÄNDERUNGEN VORBEHALTEN / SUBJECT TO ALTERATION

GRUNDIG

TV

Ersatzteilliste  
Spare Parts List

6 / 2002

## DAVIO 70 ST 70-292/8 DOLBY

MATERIAL-NR. / PART NO.: 921851027200 BESTELL-NR. / ORDER NO.: GC18472 AGANA-GRAU/AGANA GREY  
VERSION NR./VERSION NO.: VNA

POS. NR. POS. NO.	ABB. FIG.	MATERIAL-NR. PART NUMBER	ANZ. QTY.	BEZEICHNUNG <b>(D)</b>	DESCRIPTION <b>(GB)</b>
		921851027200		DAVIO 70 ST 70-292/8 DOLBY AGANA-GRAU KEIN E-TEIL	DAVIO 70 ST 70-292/8 DOLBY AGANA GREY NO SPARE PART
0050.000				PROGRAMM FLASH-EPROM DOWNLOAD: WWW.GRUNDIG.DE/ PRODUKTE/KONTAKT/HAENDLERSERVICE	PROGRAM FLASH EPROM DOWNLOAD: WWW.GRUNDIG.DE/ PRODUCTS/CONTACT/RESELLER SUPPORT
0215.000		296366440103		RAHMEN	FRAME
0218.000		295016880207		NETZTASTENKNOPF	KNOB KEY POWER
0220.000		296366450102		VERLAENGERUNG NETZTASTE	EXTENSION KNOB KEY POWER
0320.000		291102996406		TYPENAUFKLEBER VNA	TYPE LABEL SELF ADHESIVE VNA
WW.		291105226401		TYPENAUFKLEBER VNA	TYPE LABEL SELF ADHESIVE VNA
0450.000		297006544101		HALTER LEITERPLATTE	HOLDER PCB
0700.000	△	092461317601		ENTMAGNETISIERUNGSSPULE	DEGAUSSING COIL
0950.000		292104087100		SHIFTSTECKER KPL 4W/120 OHM	SHIFT PLUG CPL 4W/120 OHM
0950.000		292104087406		SHIFTSTECKER KPL 4W/220 OHM	SHIFT PLUG CPL 4W/220 OHM
2400.000		296420660300		TP 150 C FERNBEDIENUNG	TP 150 C REMOTE CONTROL
2410.000		720086745000		DECKEL BATTERIE	BATTERY LID
		218519411300		BEDIENUNGSANLEITUNG D	OPERATION INSTRUCTIONS D
		218519411400		BEDIENUNGSANLEITUNG F/I	OPERATION INSTRUCTIONS F/I
		218519411500		BEDIENUNGSANLEITUNG GB/NL	OPERATION INSTRUCTIONS GB/NL
		218519411600		BEDIENUNGSANLEITUNG E/P	OPERATION INSTRUCTIONS E/P
		218519411700		BEDIENUNGSANLEITUNG DK/FIN	OPERATION INSTRUCTIONS DK/FIN
		218519411800		BEDIENUNGSANLEITUNG S/N	OPERATION INSTRUCTIONS S/N
		720100305000		SERVICE MANUAL D/GB	SERVICE MANUAL D/GB
		720100305400		SERVICE MANUAL D/GB 4.ERGAENZUNG	SERVICE MANUAL D/GB 4TH SUPPLEMENT
		720100305500		SERVICE MANUAL D/GB 5.ERGAENZUNG	SERVICE MANUAL D/GB 5TH SUPPLEMENT
		720100305600		SERVICE MANUAL D/GB 6.ERGAENZUNG	SERVICE MANUAL D/GB 6TH SUPPLEMENT
		296560044300		MONTAGEZUBEHOER F.BILDROHR KEIN E-TEIL	MOUNTING ACCESSORIES F.PICT. TUBE NO SPARE PART
				WW. = WAHLWEISE	WW. = OPTIONAL
				ALLE ANDEREN TEILE SIEHE E-LISTE DAVIO 70 ST 70-292/8 DOLBY AGANA-GRAU MAT.-NR.: 921851027200 BESTELL-NR.: GC18472 AUSGABE 12/2000 VERSION-NR.: VNM	FOR ALL OTHER PARTS SEE DAVIO 70 ST 70-292/8 DOLBY AGANA GREY PART NO.: 921851027200 ORDER NO.: GC18472 EDITION 12/2000 VERSION NO.: VNM

ÄNDERUNGEN VORBEHALTEN / SUBJECT TO ALTERATION

POS. NR. MATERIAL-NR. BEZEICHNUNG  
POS. NO. PART NUMBER DESCRIPTIONPOS. NR. MATERIAL-NR. BEZEICHNUNG  
POS. NO. PART NUMBER DESCRIPTION

## DAVIO 70 ST 70-292/8 DOLBY

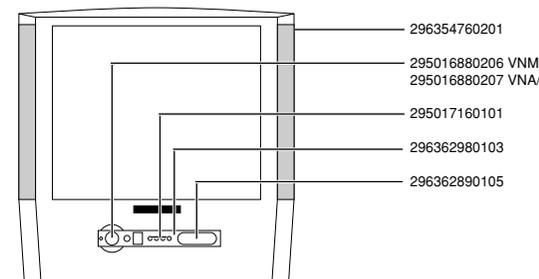

Es gelten die Vorschriften und Sicherheitshinweise gemäß dem Service Manual "Sicherheit", Mat.-Nummer 720108000000, sowie zusätzlich die eventuell abweichenden, landesspezifischen Vorschriften!



The regulations and safety instructions shall be valid as provided by the "Safety" Service Manual, part number 720108000000, as well as the respective national deviations.

ÄNDERUNGEN VORBEHALTEN / SUBJECT TO ALTERATION

## Ersatzteilliste Spare Parts List

### 6 / 2002

### DAVIO 70 ST 70-292/8 DOLBY

MATERIAL-NR. / PART NO.: 921851027200 BESTELL-NR. / ORDER NO.: GC18472 AGANA-GRAU/AGANA GREY  
VERSION NR./VERSION NO.: **VNX**

POS. NR. POS. NO.	ABB. FIG.	MATERIAL-NR. PART NUMBER	ANZ. QTY.	BEZEICHNUNG (D)	DESCRIPTION (GB)
		921851027200		DAVIO 70 ST 70-292/8 DOLBY AGANA-GRAU VNX KEIN E-TEIL	DAVIO 70 ST 70-292/8 DOLBY AGANA GREY VNX NO SPARE PART
0050.000				PROGRAMM FLASH-EPROM DOWNLOAD: WWW.GRUNDIG.DE/PRODUKTE/ KONTAKT/HAENDLERSERVICE	PROGRAM FLASH-EPROM DOWNLOAD: WWW.GRUNDIG.DE/PRODUCTS/ CONTACT/RESELLER SUPPORT
0215.000		296366440104		RAHMEN	FRAME
0218.000		295016880207		NETZTASTENKNOPF	KNOB KEY POWER
0220.000		296366450102		VERLAENGERUNG NETZTASTE	EXTENSION KNOB KEY POWER
0320.000		291102996506		TYPENAUFKLEBER VNX	TYPE LABEL SELF ADHESIVE VNX
WW.		291105226501		TYPENAUFKLEBER VNX	TYPE LABEL SELF ADHESIVE VNX
0450.000		297006544101		HALTER LEITERPLATTE	HOLDER PCB
0700.000	△	092461317601		ENTMAGNETISIERUNGSSPULE	DEGAUSSING COIL
0950.000		292104087100		SHIFTSTECKER KPL 4W/120 OHM	SHIFT PLUG CPL 4W/120 OHM
0950.000		292104087406		SHIFTSTECKER KPL 4W/220 OHM	SHIFT PLUG CPL 4W/220 OHM
2400.000		296420660300		TP 150 C FERNBEDIENUNG	TP 150 C REMOTE CONTROL
2410.000		720086745000		DECKEL BATTERIE	BATTERY LID
		218519411300		BEDIENUNGSANLEITUNG D	OPERATION INSTRUCTIONS D
		218519411400		BEDIENUNGSANLEITUNG F/I	OPERATION INSTRUCTIONS F/I
		218519411500		BEDIENUNGSANLEITUNG GB/NL	OPERATION INSTRUCTIONS GB/NL
		218519411600		BEDIENUNGSANLEITUNG E/P	OPERATION INSTRUCTIONS E/P
		218519411700		BEDIENUNGSANLEITUNG DK/FIN	OPERATION INSTRUCTIONS DK/FIN
		218519411800		BEDIENUNGSANLEITUNG S/N	OPERATION INSTRUCTIONS S/N
		720100305000		SERVICE MANUAL D/GB	SERVICE MANUAL D/GB
		720100305400		SERVICE MANUAL D/GB 4.ERGAENZUNG	SERVICE MANUAL D/GB 4TH SUPPLEMENT
		720100305500		SERVICE MANUAL D/GB 5.ERGAENZUNG	SERVICE MANUAL D/GB 5TH SUPPLEMENT
		720100305600		SERVICE MANUAL D/GB 6.ERGAENZUNG	SERVICE MANUAL D/GB 6TH SUPPLEMENT
		296560044300		MONTAGEZUBEHOER F.BILDROHR KEIN E-TEIL	MOUNTING ACCESSORIES F.PICT. TUBE NO SPARE PART
		297040190900	X	CHASSIS-FS-STEREO DIGI 100 CUC 1837 KEIN E-TEIL	CHASSIS TV STEREO DIGI 100 CUC 1837 NO SPARE PART
				X = SIEHE GESONDERTE E-LISTE WW. = WAHLWEISE	X = SEE SEPARATE PARTS LIST WW. = OPTIONAL
				ALLE ANDEREN TEILE SIEHE E-LISTE DAVIO 70 ST 70-292/8 DOLBY AGANA-GRAU MAT.-NR.: 921851027200 BESTELL-NR.: GC18472 AUSGABE 12/2000 VERSION-NR.: <b>VNM</b>	FOR ALL OTHER PARTS SEE DAVIO 70 ST 70-292/8 DOLBY AGANA GREY PART NO.: 921851027200 ORDER NO.: GC18472 EDITION 12/2000 VERSION NO.: <b>VNM</b>

ÄNDERUNGEN VORBEHALTEN / SUBJECT TO ALTERATION

POS. NR. MATERIAL-NR. BEZEICHNUNG  
POS. NO. PART NUMBER DESCRIPTION

POS. NR. MATERIAL-NR. BEZEICHNUNG  
POS. NO. PART NUMBER DESCRIPTION

### DAVIO 70 ST 70-292/8 DOLBY

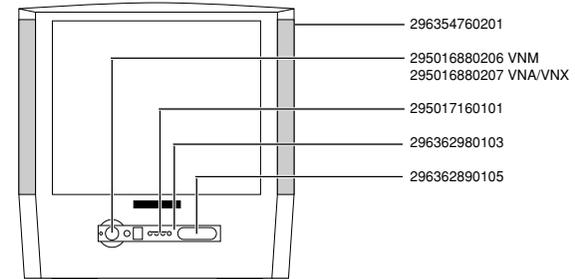

Es gelten die Vorschriften und Sicherheitshinweise gemäß dem Service Manual "Sicherheit", Mat.-Nummer 720108000000, sowie zusätzlich die eventuell abweichenden, landesspezifischen Vorschriften!



The regulations and safety instructions shall be valid as provided by the "Safety" Service Manual, part number 720108000000, as well as the respective national deviations.

ÄNDERUNGEN VORBEHALTEN / SUBJECT TO ALTERATION

### Ersatzteilliste Spare Parts List

5 / 2002

### ELEGANCE 70 ST 70-300 DOLBY

MATERIAL-NR. / PART NO.: 921916216900 BESTELL-NR. / ORDER NO.: GCM8300 TESSA BLACK  
VERSION NR./VERSION NO.: VNA

POS. NR. POS. NO.	ABB. FIG.	MATERIAL-NR. PART NUMBER	ANZ. QTY.	BEZEICHNUNG (D)	DESCRIPTION (GB)
		921916216900		ELEGANCE 70 ST 70-300 DOLBY TESSA BLACK KEIN E-TEIL	ELEGANCE 70 ST 70-300 DOLBY TESSA BLACK NO SPARE PART
0050.000				PROGRAMM FLASH-EPROM DOWNLOAD: WWW.GRUNDIG.DE/ PRODUKTE/KONTAKT/HAENDLERSERVICE	PROGRAM FLASH EPROM DOWNLOAD: WWW.GRUNDIG.DE/ PRODUCTS/CONTACT/RESELLER SUPPORT
0320.000		291104596401		TYPENAUFKLEBER VNA	TYPE LABEL VNA
0700.000	△	092461317506		ENTMAGNETISIERUNGSSPULE M.HALTER	DEGAUSSING COIL W.HOLDER
0950.000		292104087100		SHIFTSTECKER KPL 4 W/120 OHM	SHIFT PLUG CPL 4 W/120 OHM
0950.000		292104087406		SHIFTSTECKER KPL 4W/220 OHM	SHIFT PLUG CPL 4W/220 OHM
1100.000		830003047400		BILDR.A66EAK554X44	PICT.TUBE A66EAK554X44
1110.000	△	292013601106		ANODENKAPPE M.HOCHSPANNUNGSKABEL	ANODE CAP W.HIGH VOLTAGE CABLE
1300.000		295017610103		BEDIENEINSATZ MONT.KPL	CONTROL INSERT MOUNT.CPL
2400.000		296420614600		TP 100 C FERNBEDIENUNG SCHWARZ	TP 100 C REMOTE CONTROL BLACK
2410.000		720086730000		DECKEL BATTERIE TP 100 C	BATTERY LID TP 100 C
		219169411600		BEDIENUNGSANLEITUNG D/NL	OPERATING INSTRUCTIONS D/NL
		720100305000		SERVICE MANUAL D/GB	SERVICE MANUAL D/GB
		720100305400		SERVICE MANUAL D/GB 4.ERGAENZUNG	SERVICE MANUAL D/GB 4TH SUPPLEMENT
		720100305500		SERVICE MANUAL D/GB 5.ERGAENZUNG	SERVICE MANUAL D/GB 5TH SUPPLEMENT
		720100305600		SERVICE MANUAL D/GB 6.ERGAENZUNG	SERVICE MANUAL D/GB 6TH SUPPLEMENT
		297040112400	X	CHASSIS-FS-STEREO CUC 1837 DIGI 100 KEIN E-TEIL	CHASSIS TV STEREO CUC 1837 DIGI 100 NO SPARE PART
				X=SIEHE GESONDERTE E-LISTE	X=SEE SEPARATE PARTS LIST
				ALLE WEITEREN TEILE SIEHE E-LISTE ELEGANCE 70 ST 70-300 DOLBY TESSA BLACK MAT.-NR.: 921916216900 BESTELL-NR.: GCM8300 AUSGABE 11/2000 VERSION NR.: VNM	FOR ALL OTHER PARTS SEE ELEGANCE 70 ST 70-300 DOLBY TESSA BLACK PART NO: 921916216900 ORDER NR.: GCM8300 EDITION 11/2000 VERSION NO.: VNM

Es gelten die Vorschriften und Sicherheitshinweise gemäß dem Service Manual "Sicherheit", Mat.-Nummer 720108000000, sowie zusätzlich die eventuell abweichenden, landesspezifischen Vorschriften!



The regulations and safety instructions shall be valid as provided by the "Safety" Service Manual, part number 720108000000, as well as the respective national deviations.

ÄNDERUNGEN VORBEHALTEN / SUBJECT TO ALTERATION

### Ersatzteilliste Spare Parts List

5 / 2002

### ELEGANCE 70 ST 70-300 DOLBY

MATERIAL-NR. / PART NO.: 921916216900 BESTELL-NR. / ORDER NO.: GCM8300 TESSA BLACK  
VERSION NR./VERSION NO.: VNX

POS. NR. POS. NO.	ABB. FIG.	MATERIAL-NR. PART NUMBER	ANZ. QTY.	BEZEICHNUNG (D)	DESCRIPTION (GB)
		921916216900		ELEGANCE 70 ST 70-300 DOLBY TESSA BLACK KEIN E-TEIL	ELEGANCE 70 ST 70-300 DOLBY TESSA BLACK NO SPARE PART
0050.000				PROGRAMM FLASH-EPROM DOWNLOAD: WWW.GRUNDIG.DE/ PRODUKTE/KONTAKT/HAENDLERSERVICE	PROGRAM FLASH EPROM DOWNLOAD: WWW.GRUNDIG.DE/ PRODUCTS/CONTACT/RESELLER SUPPORT
0312.000		297006510103		ABDECKUNG DIGI-100	COVER DIGI-100
0320.000		291103966502		TYPENAUFKLEBER VNX	TYPE LABEL VNX
0700.000	△	092461317506		ENTMAGNETISIERUNGSSPULE M.HALTER	DEGAUSSING COIL W.HOLDER
0950.000		292104087100		SHIFTSTECKER KPL 4 W/120 OHM	SHIFT PLUG CPL 4 W/120 OHM
0950.000		292104087406		SHIFTSTECKER KPL 4W/220 OHM	SHIFT PLUG CPL 4W/220 OHM
1300.000		295017610103		BEDIENEINSATZ MONT.KPL	CONTROL INSERT MOUNT.CPL
2400.000		296420660300		TP 150 C FERNBEDIENUNG SCHWARZ	TP 150 C REMOTE CONTROL BLACK
		219169414600		BEDIENUNGSANLEITUNG D/NL	OPERATING INSTRUCTIONS D/NL
		720100305000		SERVICE MANUAL D/GB	SERVICE MANUAL D/GB
		720100305400		SERVICE MANUAL D/GB 4.ERGAENZUNG	SERVICE MANUAL D/GB 4TH SUPPLEMENT
		720100305500		SERVICE MANUAL D/GB 5.ERGAENZUNG	SERVICE MANUAL D/GB 5TH SUPPLEMENT
		720100305600		SERVICE MANUAL D/GB 6.ERGAENZUNG	SERVICE MANUAL D/GB 6TH SUPPLEMENT
		297040111200	X	CHASSIS-FS-STEREO CUC 1837 DIGI 100 KEIN E-TEIL	CHASSIS TV STEREO CUC 1837 DIGI 100 NO SPARE PART
				X=SIEHE GESONDERTE E-LISTE	X=SEE SEPARATE PARTS LIST
				ALLE WEITEREN TEILE SIEHE E-LISTE ELEGANCE 70 ST 70-300 DOLBY TESSA BLACK MAT.-NR.: 921916216900 BESTELL-NR.: GCM8300 AUSGABE 11/2000 VERSION NR.: VNM	FOR ALL OTHER PARTS SEE ELEGANCE 70 ST 70-300 DOLBY TESSA BLACK PART NO: 921916216900 ORDER NR.: GCM8300 EDITION 11/2000 VERSION NO.: VNM

Es gelten die Vorschriften und Sicherheitshinweise gemäß dem Service Manual "Sicherheit", Mat.-Nummer 720108000000, sowie zusätzlich die eventuell abweichenden, landesspezifischen Vorschriften!



The regulations and safety instructions shall be valid as provided by the "Safety" Service Manual, part number 720108000000, as well as the respective national deviations.

ÄNDERUNGEN VORBEHALTEN / SUBJECT TO ALTERATION

Ersatzteilliste  
Spare Parts List**GRUNDIG****TV****5 / 2002****ELEGANCE 70 ST 70-300 DOLBY**MATERIAL-NR. / PART NO.: 921916216900 BESTELL-NR. / ORDER NO.: GCM8300 TESSA BLACK  
VERSION NR./VERSION NO.: **VNG**

POS. NR. POS. NO.	ABB. FIG.	MATERIAL-NR. PART NUMBER	ANZ. QTY.	BEZEICHNUNG <b>(D)</b>	DESCRIPTION <b>(GB)</b>
		921916216900		ELEGANCE 70 ST 70-300 DOLBY TESSA BLACK KEIN E-TEIL	ELEGANCE 70 ST 70-300 DOLBY TESSA BLACK NO SPARE PART
0050.000				PROGRAMM FLASH-EPROM DOWNLOAD: WWW.GRUNDIG.DE/ PRODUKTE/KONTAKT/HAENDLERSERVICE	PROGRAM FLASH EPROM DOWNLOAD: WWW.GRUNDIG.DE/ PRODUCTS/CONTACT/RESELLER SUPPORT
0312.000		297006510103		ABDECKUNG DIGI-100	COVER DIGI-100
0320.000		291104596601		TYPENAUFKLEBER VNG	TYPE LABEL VNG
0700.000	△	092461317506		ENTMAGNETISIERUNGSSPULE M.HALTER	DEGAUSSING COIL W.HOLDER
0950.000		292104087100		SHIFTSTECKER KPL 4 W/120 OHM	SHIFT PLUG CPL 4 W/120 OHM
0950.000		292104087406		SHIFTSTECKER KPL 4W/220 OHM	SHIFT PLUG CPL 4W/220 OHM
1100.000		830003047400		BILDR.A66EAK554X44	PICT.TUBE A66EAK554X44
1110.000	△	292013601106		ANODENKAPPE M.HOCHSPANNUNGSKABEL	ANODE CAP W.HIGH VOLTAGE CABLE
1300.000		295017610103		BEDIENEINSATZ MONT.KPL	CONTROL INSERT MOUNT.CPL
2400.000		296420660300		TP 150 C FERNBEDIENUNG SCHWARZ	TP 150 C REMOTE CONTROL BLACK
		219169414700		BEDIENUNGSANLEITUNG D/NL	OPERATING INSTRUCTIONS D/NL
		720100305000		SERVICE MANUAL D/GB	SERVICE MANUAL D/GB
		720100305400		SERVICE MANUAL D/GB 4.ERGAENZUNG	SERVICE MANUAL D/GB 4TH SUPPLEMENT
		720100305500		SERVICE MANUAL D/GB 5.ERGAENZUNG	SERVICE MANUAL D/GB 5TH SUPPLEMENT
		720100305500		SERVICE MANUAL D/GB 6.ERGAENZUNG	SERVICE MANUAL D/GB 6TH SUPPLEMENT
		297040112400	X	CHASSIS-FS-STEREO CUC 1837 DIGI 100 KEIN E-TEIL	CHASSIS TV STEREO CUC 1837 DIGI 100 NO SPARE PART
				X=SIEHE GESONDERTE E-LISTE	X=SEE SEPARATE PARTS LIST
				ALLE WEITEREN TEILE SIEHE E-LISTE ELEGANCE 70 ST 70-300 DOLBY TESSA BLACK MAT.-NR.: 921916216900 BESTELL-NR.: GCM8300 AUSGABE 11/2000 VERSION NR.: <b>VNM</b>	FOR ALL OTHER PARTS SEE ELEGANCE 70 ST 70-300 DOLBY TESSA BLACK PART NO: 921916216900 ORDER NR.: GCM8300 EDITION 11/2000 VERSION NO.: <b>VNM</b>

Es gelten die Vorschriften und Sicherheitshinweise gemäß dem Service Manual "Sicherheit", Mat.-Nummer 720108000000, sowie zusätzlich die eventuell abweichenden, landesspezifischen Vorschriften!



The regulations and safety instructions shall be valid as provided by the "Safety" Service Manual, part number 720108000000, as well as the respective national deviations.

ÄNDERUNGEN VORBEHALTEN / SUBJECT TO ALTERATION

**5 / 2002**

**ELEGANCE 70 ST 70-300 DOLBY**

MATERIAL-NR. / PART NO.: 921916216900 BESTELL-NR. / ORDER NO.: GCM8300 TESSA BLACK  
VERSION NR./VERSION NO.: VNR

POS. NR. POS. NO.	ABB. FIG.	MATERIAL-NR. PART NUMBER	ANZ. QTY.	BEZEICHNUNG <b>(D)</b>	DESCRIPTION <b>(GB)</b>
		921916216900		ELEGANCE 70 ST 70-300 DOLBY TESSA BLACK KEIN E-TEIL	ELEGANCE 70 ST 70-300 DOLBY TESSA BLACK NO SPARE PART
0050.000				PROGRAMM FLASH-EPROM DOWNLOAD: WWW.GRUNDIG.DE/ PRODUKTE/KONTAKT/HAENDLERSERVICE	PROGRAM FLASH EPROM DOWNLOAD: WWW.GRUNDIG.DE/ PRODUCTS/CONTACT/RESELLER SUPPORT
0312.000		297006510103		ABDECKUNG DIGI-100	COVER DIGI-100
0320.000		291103966702		TYPENAUFKLEBER VNR	TYPE LABEL VNR
0700.000	△	092461317507		ENTMAGNETISIERUNGSSPULE M.HALTER	DEGAUSSING COIL W.HOLDER
0950.000		292104087100		SHIFTSTECKER KPL 4 W/120 OHM	SHIFT PLUG CPL 4 W/120 OHM
0950.000		292104087406		SHIFTSTECKER KPL 4W/220 OHM	SHIFT PLUG CPL 4W/220 OHM
1300.000		295017610104		BEDIENEINSATZ MONT.KPL	CONTROL INSERT MOUNT.CPL
1301.000		295017620202		KLAPPE DRUCK KPL	FLAP PRINT CPL
2400.000		296420660300		TP 150 C FERNBEDIENUNG SCHWARZ	TP 150 C REMOTE CONTROL BLACK
		219169414600		BEDIENUNGSANLEITUNG D/NL	OPERATING INSTRUCTIONS D/NL
		720100305000		SERVICE MANUAL D/GB	SERVICE MANUAL D/GB
		720100305400		SERVICE MANUAL D/GB 4.ERGAENZUNG	SERVICE MANUAL D/GB 4TH SUPPLEMENT
		720100305500		SERVICE MANUAL D/GB 5.ERGAENZUNG	SERVICE MANUAL D/GB 5TH SUPPLEMENT
		720100305600		SERVICE MANUAL D/GB 6.ERGAENZUNG	SERVICE MANUAL D/GB 6TH SUPPLEMENT
		297040191800	X	CHASSIS-FS-STEREO CUC 1837 DIGI 100 KEIN E-TEIL	CHASSIS TV STEREO CUC 1837 DIGI 100 NO SPARE PART
				X=SIEHE GESONDERTE E-LISTE	X=SEE SEPARATE PARTS LIST
				ALLE WEITEREN TEILE SIEHE E-LISTE ELEGANCE 70 ST 70-300 DOLBY TESSA BLACK MAT.-NR.: 921916216900 BESTELL-NR.: GCM8300 AUSGABE 11/2000 VERSION NR.: VNM	FOR ALL OTHER PARTS SEE ELEGANCE 70 ST 70-300 DOLBY TESSA BLACK PART NO: 921916216900 ORDER NR.: GCM8300 EDITION 11/2000 VERSION NO.: VNM

**ELEGANCE 70 ST 70-300 DOLBY**

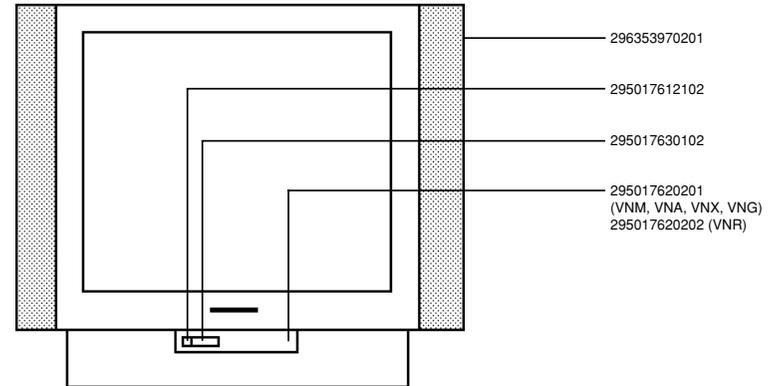

POS. NR. POS. NO.	MATERIAL-NR. PART NUMBER	BEZEICHNUNG DESCRIPTION
----------------------	-----------------------------	----------------------------

POS. NR. POS. NO.	MATERIAL-NR. PART NUMBER	BEZEICHNUNG DESCRIPTION
----------------------	-----------------------------	----------------------------

Es gelten die Vorschriften und Sicherheitshinweise gemäß dem Service Manual "Sicherheit", Mat.-Nummer 720108000000, sowie zusätzlich die eventuell abweichenden, landesspezifischen Vorschriften!



The regulations and safety instructions shall be valid as provided by the "Safety" Service Manual, part number 720108000000, as well as the respective national deviations.

MATERIAL-NR. / PART NO.: 921916216900 BESTELL-NR. / ORDER NO.: GCM8300 TESSA BLACK  
VERSION NR./VERSION NO.: **VNU**

POS. NR. POS. NO.	ABB. FIG.	MATERIAL-NR. PART NUMBER	ANZ. QTY.	BEZEICHNUNG (D)	DESCRIPTION (GB)
		921916216900		ELEGANCE 70 ST 70-300 DOLBY TESSA BLACK KEIN E-TEIL	ELEGANCE 70 ST 70-300 DOLBY TESSA BLACK NO SPARE PART
0050.000				PROGRAMM FLASH-EPROM DOWNLOAD: WWW.GRUNDIG.DE/ PRODUKTE/KONTAKT/HAENDLERSERVICE	PROGRAM FLASH EPROM DOWNLOAD: WWW.GRUNDIG.DE/ PRODUCTS/CONTACT/RESELLER SUPPORT
0312.000		297006510103		ABDECKUNG DIGI-100	COVER DIGI-100
0320.000		291104596801		TYPENAUFKLEBER VNU	TYPE LABEL VNU
0700.000	△	092461317507		ENTMAGNETISIERUNGSSPULE M.HALTER	DEGAUSSING COIL W.HOLDER
0950.000		292104087100		SHIFTSTECKER KPL 4 W/120 OHM	SHIFT PLUG CPL 4 W/120 OHM
0950.000		292104087406		SHIFTSTECKER KPL 4W/220 OHM	SHIFT PLUG CPL 4W/220 OHM
1100.000		830003047400		BILDR.A66EAK554X44	PICT.TUBE A66EAK554X44
1110.000	△	292013601106		ANODENKAPPE M.HOCHSPANNUNGSKABEL	ANODE CAP W.HIGH VOLTAGE CABLE
1300.000		295017610104		BEDIENEINSATZ MONT.KPL	CONTROL INSERT MOUNT.CPL
1301.000		295017620202		KLAPPE DRUCK KPL	FLAP PRINT CPL
2400.000		296420660300		TP 150 C FERNBEDIENUNG SCHWARZ	TP 150 C REMOTE CONTROL BLACK
		219169414700		BEDIENUNGSANLEITUNG D/NL	OPERATING INSTRUCTIONS D/NL
		720100305000		SERVICE MANUAL D/GB	SERVICE MANUAL D/GB
		720100305400		SERVICE MANUAL D/GB 4.ERGAENZUNG	SERVICE MANUAL D/GB 4TH SUPPLEMENT
		720100305500		SERVICE MANUAL D/GB 5.ERGAENZUNG	SERVICE MANUAL D/GB 5TH SUPPLEMENT
		720100305600		SERVICE MANUAL D/GB 6.ERGAENZUNG	SERVICE MANUAL D/GB 6TH SUPPLEMENT
		297040191300	X	CHASSIS-FS-STEREO CUC 1837 DIGI 100 KEIN E-TEIL	CHASSIS TV STEREO CUC 1837 DIGI 100 NO SPARE PART
				X=SIEHE GESONDERTE E-LISTE	X=SEE SEPARATE PARTS LIST
				ALLE WEITEREN TEILE SIEHE E-LISTE ELEGANCE 70 ST 70-300 DOLBY TESSA BLACK MAT.-NR.: 921916216900 BESTELL-NR.: GCM8300 AUSGABE 11/2000 VERSION NR.: <b>VNM</b>	FOR ALL OTHER PARTS SEE ELEGANCE 70 ST 70-300 DOLBY TESSA BLACK PART NO.: 921916216900 ORDER NR.: GCM8300 EDITION 11/2000 VERSION NO.: <b>VNM</b>

POS. NR. MATERIAL-NR. BEZEICHNUNG  
POS. NO. PART NUMBER DESCRIPTION

POS. NR. MATERIAL-NR. BEZEICHNUNG  
POS. NO. PART NUMBER DESCRIPTION

### ELEGANCE 70 ST 70-300 DOLBY

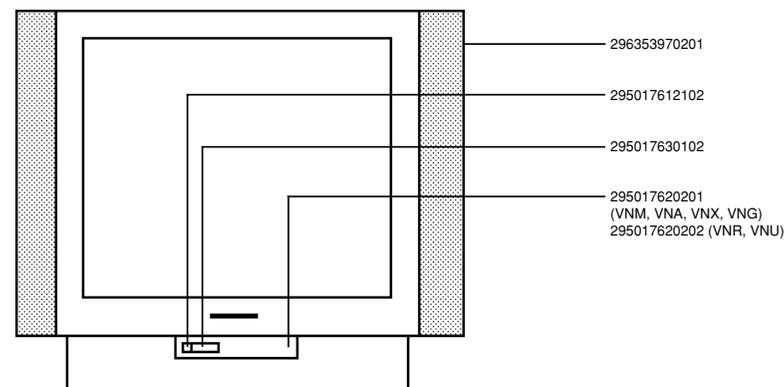

Es gelten die Vorschriften und Sicherheitshinweise gemäß dem Service Manual "Sicherheit", Mat.-Nummer 720108000000, sowie zusätzlich die eventuell abweichenden, landesspezifischen Vorschriften!



The regulations and safety instructions shall be valid as provided by the "Safety" Service Manual, part number 720108000000, as well as the respective national deviations.

ÄNDERUNGEN VORBEHALTEN / SUBJECT TO ALTERATION

ÄNDERUNGEN VORBEHALTEN / SUBJECT TO ALTERATION

MATERIAL-NR. / PART NO.: 921916219200 BESTELL-NR. / ORDER NO.: GCM8310 TITANE  
VERSION NR./VERSION NO.: VNM/VNA

POS. NR. POS. NO.	ABB. FIG.	MATERIAL-NR. PART NUMBER	ANZ. QTY.	BEZEICHNUNG (D)	DESCRIPTION (GB)
		921916219200		ELEGANCE 70 ST 70-300 DOLBY TITANE KEIN E-TEIL	ELEGANCE 70 ST 70-300 DOLBY TITANE NO SPARE PART
0200.000		296353970302		GEH-VORDERTEIL DRUCK KPL	CABINET FRONT PART PRINT
0201.000		191260359701	2	LAUTSPRECHER	LOUDSPEAKER
0217.000		296088640102	5	SOCKELEINLAGE	BASE INSERT
0300.000		296366070401		GEH-RUECKTEIL OFB	CABINET REAR PART SURFACE
0312.000		297006510102		ABDECKUNG DIGI-100	COVER DIGI-100
0313.000		297006530101		ABDECKUNG FLASH	COVER FLASH
0320.000		291103966302		TYPENAUFKLEBER VNM	TYPE LABEL VNM
0320.000		291104596401		TYPENAUFKLEBER VNA	TYPE LABEL VNA
0700.000	△	092461317506		ENTMAGNETISIERUNGSSPULE M.HALTER	DEGAUSSING COIL W.HOLDER
0770.000		296364810102	4	BEFESTIGUNGS-EINSATZ BILDROHR	HOLDER INSERT PICT.TUBE
1100.000	△	830003043600		BILDR.A 66 EAK 075X44 PHILIPS VNM	PICT.TUBE A 66 EAK 075X44 PHILIPS VNM
1100.000	△	830003047400		BILDR.A 66 EAK 554X44 PHILIPS VNA	PICT.TUBE A 66 EAK 554X44 PHILIPS VNA
1110.000	△	292013600211		ANODENKAPPE M.HOCHSPANNUNGSK.VNM	ANODE CAP W.HIGH VOLTAGE CABLE VNM
1110.000	△	292013601106		ANODENKAPPE M.HOCHSPANNUNGSK.VNA	ANODE CAP W.HIGH VOLTAGE CABLE VNA
1300.000		295017610103		BEDIENEINSATZ MONT.KPL	CONTROL INSERT MOUNT.CPL
1301.000		295017620301		KLAPPE DRUCK KPL	FLAP PRINT CPL
1350.000		295017660102		TASTENSATZ PROGRAMM/LAUTSTAERKE	KEY SET PROGRAMME/VOLUME
1382.000		295017630102		IR-FENSTER	IR WINDOW
1383.000		293033904200		KOPFHUERERBUCHSE 3,5 O.SCHALTER	HEADPHONE SOCKET 3,5 W/O SWITCH
1384.000		293031680503		CINCH-BUCHSE 3-FACH FBAS/NF L,R	CINCH SOCKET 3 FOLD FBAS/AF L,R
2100.000	△	829099131600		NETZKABEL	POWER CABLE
2300.000	△	293051223100	X	BILDROHRPLATTE DIGI 100	PICT.TUBE BOARD DIGI 100
2400.000		296420614600		TP 100 C FERNBEDIENUNG	TP 100 C REMOTE CONTROL
2410.000		720086730000		DECKEL BATTERIE TP 100 C	BATTERY LID TP 100 C
		219169410300		BEDIENUNGSANLEITUNG D/NL VNM	OPERATING INSTRUCTIONS D/NL VNM
		219169411600		BEDIENUNGSANLEITUNG D/NL VNA	OPERATING INSTRUCTIONS D/NL VNA
		720100305000		SERVICE MANUAL D/GB	SERVICE MANUAL D/GB
		296560040200		MONTAGEZUBEHOER F.BILDROHR KEIN E-TEIL	MOUNTING ACCESSORIES F.PICT.TUBE NO SPARE PART
		297040111200	X	CHASSIS-FS-STEREO VNM CUC 1837 DIGI 100 KEIN E-TEIL	CHASSIS TV STEREO VNM CUC 1837 DIGI 100 NO SPARE PART
		297040112400	X	CHASSIS-FS-STEREO VNA CUC 1837 DIGI 100 KEIN E-TEIL	CHASSIS TV STEREO VNA CUC 1837 DIGI 100 NO SPARE PART
				X = SIEHE GESONDERTE E-LISTE	X = SEE SEPARATE PARTS LIST
				HINWEIS: DIE AKTUELLE SOFTWARE KOENNEN SIE IM INTERNET UNTER FOLGENDER ADRESSE ABRUFEN: WWW.GRUNDIG.DE MENU: SOFTWARE-DOWNLOAD	NOTE: YOU MAY DOWNLOAD THE CURRENT SOFTWARE IN THE INTERNET UNDER THE FOLLOWING ADDRESS: WWW.GRUNDIG.DE MENU: SOFTWARE-DOWNLOAD

ÄNDERUNGEN VORBEHALTEN / SUBJECT TO ALTERATION

POS. NR. MATERIAL-NR. BEZEICHNUNG  
POS. NO. PART NUMBER DESCRIPTION

POS. NR. MATERIAL-NR. BEZEICHNUNG  
POS. NO. PART NUMBER DESCRIPTION

#### ELEGANCE 70 ST 70-300 DOLBY

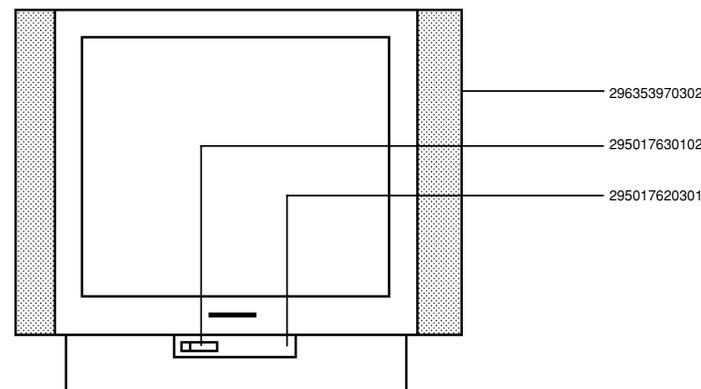

Es gelten die Vorschriften und Sicherheitshinweise gemäß dem Service Manual "Sicherheit", Mat.-Nummer 720108000000, sowie zusätzlich die eventuell abweichenden, landesspezifischen Vorschriften!



The regulations and safety instructions shall be valid as provided by the "Safety" Service Manual, part number 720108000000, as well as the respective national deviations.

ÄNDERUNGEN VORBEHALTEN / SUBJECT TO ALTERATION

**GRUNDIG****TV****Ersatzteilliste  
Spare Parts List****5 / 2002****ELEGANCE 70 ST 70-300 DOLBY**MATERIAL-NR. / PART NO.: 921916219200 BESTELL-NR. / ORDER NO.: GCM8310 TITANE  
VERSION NR./VERSION NO.: VNX

POS. NR. POS. NO.	ABB. FIG.	MATERIAL-NR. PART NUMBER	ANZ. QTY.	BEZEICHNUNG (D)	DESCRIPTION (GB)
		921916219200		ELEGANCE 70 ST 70-300 DOLBY TITANE KEIN E-TEIL	ELEGANCE 70 ST 70-300 DOLBY TITANE NO SPARE PART
0050.000		PROGRAMM FLASH-EPROM DOWNLOAD: WWW.GRUNDIG.DE/ PRODUKTE/KONTAKT/HAENDLERSERVICE		PROGRAMM FLASH-EPROM DOWNLOAD: WWW.GRUNDIG.DE/ PRODUKTE/KONTAKT/RESELLER SUPPORT	PROGRAM FLASH EPROM DOWNLOAD: WWW.GRUNDIG.DE/ PRODUCTS/CONTACT/RESELLER SUPPORT
0312.000 0320.000 0950.000 0950.000		297006510103 291103966502 292104087100 292104087406		ABDECKUNG DIGI-100 TYPENAUFKLEBER VNX SHIFTSTECKER KPL 4 W/120 OHM SHIFTSTECKER KPL 4W/220 OHM	COVER DIGI-100 TYPE LABEL VNX SHIFT PLUG CPL 4 W/120 OHM SHIFT PLUG CPL 4W/220 OHM
1353.000 1354.000 1370.000 1371.000		270332210100 296380231301 295017612102 293033750802	2	DRUCKSCHNAPPER DAEMPFUNGSBLOCK TASTENKNOPF NETZ DRUCKFEDER TASTENKNOPF NETZ	PRESSURE CATCH DAMPING BLOCK KEY KNOB POWER PRESSURE SPRING KEY KNOB POWER
2400.000		296420660300		TP 150 C FERNBEDIENUNG SCHWARZ	TP 150 C REMOTE CONTROL BLACK
		219169414600 720100305000 720100305400 720100305500 720100305600		BEDIENUNGSANLEITUNG D/NL SERVICE MANUAL D/GB SERVICE MANUAL D/GB 4.ERGAENZUNG SERVICE MANUAL D/GB 5.ERGAENZUNG SERVICE MANUAL D/GB 6.ERGAENZUNG	OPERATING INSTRUCTIONS D/NL SERVICE MANUAL D/GB SERVICE MANUAL D/GB 4TH SUPPLEMENT SERVICE MANUAL D/GB 5TH SUPPLEMENT SERVICE MANUAL D/GB 6TH SUPPLEMENT
		ALLE WEITEREN TEILE SIEHE E-LISTE ELEGANCE 70 ST 70-300 DOLBY TITANE MAT.-NR.: 921916219200 BESTELL-NR.: GCM8310 AUSGABE 4/2001 VERSION NR.: VNM		FOR ALL OTHER PARTS SEE ELEGANCE 70 ST 70-300 DOLBY TITANE PART NO.: 921916219200 ORDER NR.: GCM8310 EDITION 4/2001 VERSION NO.: VNM	

**GRUNDIG****TV****Ersatzteilliste  
Spare Parts List****5 / 2002****ELEGANCE 70 ST 70-300 DOLBY**MATERIAL-NR. / PART NO.: 921916219200 BESTELL-NR. / ORDER NO.: GCM8310 TITANE  
VERSION NR./VERSION NO.: VNG

POS. NR. POS. NO.	ABB. FIG.	MATERIAL-NR. PART NUMBER	ANZ. QTY.	BEZEICHNUNG (D)	DESCRIPTION (GB)
		921916219200		ELEGANCE 70 ST 70-300 DOLBY TITANE KEIN E-TEIL	ELEGANCE 70 ST 70-300 DOLBY TITANE NO SPARE PART
0050.000		PROGRAMM FLASH-EPROM DOWNLOAD: WWW.GRUNDIG.DE/ PRODUKTE/KONTAKT/HAENDLERSERVICE		PROGRAMM FLASH-EPROM DOWNLOAD: WWW.GRUNDIG.DE/ PRODUKTE/KONTAKT/RESELLER SUPPORT	PROGRAM FLASH EPROM DOWNLOAD: WWW.GRUNDIG.DE/ PRODUCTS/CONTACT/RESELLER SUPPORT
0312.000 0320.000 0950.000 0950.000 1100.000 1110.000		297006510103 291104596601 292104087100 292104087406 830003047400 292013601106		ABDECKUNG DIGI-100 TYPENAUFKLEBER VNG SHIFTSTECKER KPL 4 W/120 OHM SHIFTSTECKER KPL 4W/220 OHM BILDR.A66EAK554X44 ANODENKAPPE M.HOCHSPANNUNGSKABEL	COVER DIGI-100 TYPE LABEL VNG SHIFT PLUG CPL 4 W/120 OHM SHIFT PLUG CPL 4W/220 OHM PICT.TUBE A66EAK554X44 ANODE CAP W.HIGH VOLTAGE CABLE
1353.000 1354.000 1370.000 1371.000		270332210100 296380231301 295017612102 293033750802	2	DRUCKSCHNAPPER DAEMPFUNGSBLOCK TASTENKNOPF NETZ DRUCKFEDER TASTENKNOPF NETZ	PRESSURE CATCH DAMPING BLOCK KEY KNOB POWER PRESSURE SPRING KEY KNOB POWER
2400.000		296420660300		TP 150 C FERNBEDIENUNG SCHWARZ	TP 150 C REMOTE CONTROL BLACK
		219169414700 720100305000 720100305400 720100305500 720100305600		BEDIENUNGSANLEITUNG D/NL SERVICE MANUAL D/GB SERVICE MANUAL D/GB 4.ERGAENZUNG SERVICE MANUAL D/GB 5.ERGAENZUNG SERVICE MANUAL D/GB 6.ERGAENZUNG	OPERATING INSTRUCTIONS D/NL SERVICE MANUAL D/GB SERVICE MANUAL D/GB 4TH SUPPLEMENT SERVICE MANUAL D/GB 5TH SUPPLEMENT SERVICE MANUAL D/GB 6TH SUPPLEMENT
		ALLE WEITEREN TEILE SIEHE E-LISTE ELEGANCE 70 ST 70-300 DOLBY TITANE MAT.-NR.: 921916219200 BESTELL-NR.: GCM8310 AUSGABE 4/2001 VERSION NR.: VNM		FOR ALL OTHER PARTS SEE ELEGANCE 70 ST 70-300 DOLBY TITANE PART NO.: 921916219200 ORDER NR.: GCM8310 EDITION 4/2001 VERSION NO.: VNM	
		297040112400	X	CHASSIS-FS-STEREO CUC 1837 DIGI 100 KEIN E-TEIL	CHASSIS TV STEREO CUC 1837 DIGI 100 NO SPARE PART
		X=SIEHE GESONDERTE E-LISTE		X=SEE SEPARATE PARTS LIST	
		ALLE WEITEREN TEILE SIEHE E-LISTE ELEGANCE 70 ST 70-300 DOLBY TITANE MAT.-NR.: 921916219200 BESTELL-NR.: GCM8310 AUSGABE 4/2001 VERSION NR.: VNM		FOR ALL OTHER PARTS SEE ELEGANCE 70 ST 70-300 DOLBY TITANE PART NO.: 921916219200 ORDER NR.: GCM8310 EDITION 4/2001 VERSION NO.: VNM	

Es gelten die Vorschriften und Sicherheitshinweise gemäß dem Service Manual "Sicherheit", Mat.-Nummer 720108000000, sowie zusätzlich die eventuell abweichenden, landesspezifischen Vorschriften!



The regulations and safety instructions shall be valid as provided by the "Safety" Service Manual, part number 720108000000, as well as the respective national deviations.

ÄNDERUNGEN VORBEHALTEN / SUBJECT TO ALTERATION

Es gelten die Vorschriften und Sicherheitshinweise gemäß dem Service Manual "Sicherheit", Mat.-Nummer 720108000000, sowie zusätzlich die eventuell abweichenden, landesspezifischen Vorschriften!



The regulations and safety instructions shall be valid as provided by the "Safety" Service Manual, part number 720108000000, as well as the respective national deviations.

ÄNDERUNGEN VORBEHALTEN / SUBJECT TO ALTERATION

# Ersatzteilliste Spare Parts List

## 5 / 2002

## ELEGANCE 70 ST 70-300 DOLBY

MATERIAL-NR. / PART NO.: 921916219200 BESTELL-NR. / ORDER NO.: GCM8310 TITANE  
VERSION NR./VERSION NO.: VNR

POS. NR. POS. NO.	ABB. FIG.	MATERIAL-NR. PART NUMBER	ANZ. QTY.	BEZEICHNUNG (D)	DESCRIPTION (GB)
		921916219200		ELEGANCE 70 ST 70-300 DOLBY TITANE KEIN E-TEIL	ELEGANCE 70 ST 70-300 DOLBY TITANE NO SPARE PART
0050.000				PROGRAMM FLASH-EPROM DOWNLOAD: WWW.GRUNDIG.DE/ PRODUKTE/KONTAKT/HAENDLERSERVICE	PROGRAM FLASH EPROM DOWNLOAD: WWW.GRUNDIG.DE/ PRODUCTS/CONTACT/RESELLER SUPPORT
0312.000 0320.000 0700.000 0950.000 0950.000		297006510103 291103966702 092461317507 292104087100 292104087406		ABDECKUNG DIGI-100 TYPENAUFKLEBER VNR ENTMAGNETISIERUNGSSPULE M.HALTER SHIFTSTECKER KPL 4 W/120 OHM SHIFTSTECKER KPL 4W/220 OHM	COVER DIGI-100 TYPE LABEL VNR DEGAUSSING COIL W.HOLDER SHIFT PLUG CPL 4 W/120 OHM SHIFT PLUG CPL 4W/220 OHM
1300.000 1301.000 1353.000 1354.000 1370.000 1371.000		295017610104 295017620302 270332210100 296380231301 295017612102 293033750802		BEDIENEINSATZ MONT.KPL KLAPPE DRUCK KPL DRUCKSCHNAPPER DAEMPFUNGSBLOCK TASTENKNOPF NETZ DRUCKFEDER TASTENKNOPF NETZ	CONTROL INSERT MOUNT.CPL FLAP PRINT CPL PRESSURE CATCH DAMPING BLOCK KEY KNOB POWER PRESSURE SPRING KEY KNOB POWER
2400.000		296420660300		TP 150 C FERNBEDIENUNG SCHWARZ	TP 150 C REMOTE CONTROL BLACK
		219169414600 720100305000 720100305400 720100305500 720100305600		BEDIENUNGSANLEITUNG D/NL SERVICE MANUAL D/GB SERVICE MANUAL D/GB 4.ERGAENZUNG SERVICE MANUAL D/GB 5.ERGAENZUNG SERVICE MANUAL D/GB 6.ERGAENZUNG	OPERATING INSTRUCTIONS D/NL SERVICE MANUAL D/GB SERVICE MANUAL D/GB 4TH SUPPLEMENT SERVICE MANUAL D/GB 5TH SUPPLEMENT SERVICE MANUAL D/GB 6TH SUPPLEMENT
		297040191800	X	CHASSIS-FS-STEREO CUC 1837 DIGI 100 KEIN E-TEIL	CHASSIS TV STEREO CUC 1837 DIGI 100 NO SPARE PART
				X=SIEHE GESONDERTE E-LISTE	X=SEE SEPARATE PARTS LIST
				ALLE WEITEREN TEILE SIEHE E-LISTE ELEGANCE 70 ST 70-300 DOLBY TITANE MAT.-NR.: 921916219200 BESTELL-NR.: GCM8310 AUSGABE 4/2001 VERSION NR.: VNM	FOR ALL OTHER PARTS SEE ELEGANCE 70 ST 70-300 DOLBY TITANE PART NO.: 921916219200 ORDER NR.: GCM8310 EDITION 4/2001 VERSION NO.: VNM

# GRUNDIG

# TV

POS. NR. MATERIAL-NR. BEZEICHNUNG  
POS. NO. PART NUMBER DESCRIPTION

POS. NR. MATERIAL-NR. BEZEICHNUNG  
POS. NO. PART NUMBER DESCRIPTION

## ELEGANCE 70 ST 70-300 DOLBY

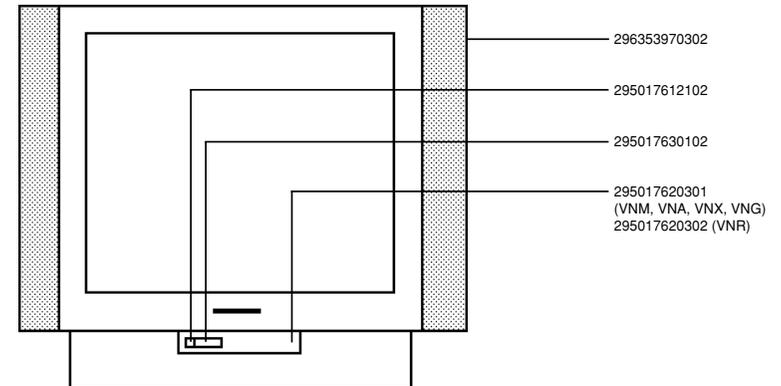

Es gelten die Vorschriften und Sicherheitshinweise gemäß dem Service Manual "Sicherheit", Mat.-Nummer 720108000000, sowie zusätzlich die eventuell abweichenden, landesspezifischen Vorschriften!



The regulations and safety instructions shall be valid as provided by the "Safety" Service Manual, part number 720108000000, as well as the respective national deviations.

ÄNDERUNGEN VORBEHALTEN / SUBJECT TO ALTERATION

ÄNDERUNGEN VORBEHALTEN / SUBJECT TO ALTERATION

### Ersatzteilliste Spare Parts List

5 / 2002

### ELEGANCE 70 ST 70-300 DOLBY

MATERIAL-NR. / PART NO.: 921916219200 BESTELL-NR. / ORDER NO.: GCM8310 TITANE  
VERSION NR./VERSION NO.: VNU

POS. NR. POS. NO.	ABB. FIG.	MATERIAL-NR. PART NUMBER	ANZ. QTY.	BEZEICHNUNG (D)	DESCRIPTION (GB)
		921916219200		ELEGANCE 70 ST 70-300 DOLBY TITANE KEIN E-TEIL	ELEGANCE 70 ST 70-300 DOLBY TITANE NO SPARE PART
0050.000				PROGRAMM FLASH-EPROM DOWNLOAD: WWW.GRUNDIG.DE/ PRODUKTE/KONTAKT/HAENDLERSERVICE	PROGRAM FLASH EPROM DOWNLOAD: WWW.GRUNDIG.DE/ PRODUCTS/CONTACT/RESELLER SUPPORT
0312.000		297006510103		ABDECKUNG DIGI-100	COVER DIGI-100
0320.000		291104596801		TYPENAUFKLEBER VNU	TYPE LABEL VNU
0700.000	△	092461317507		ENTMAGNETISIERUNGSSPULE M.HALTER	DEGAUSSING COIL W.HOLDER
0950.000		292104087100		SHIFTSTECKER KPL 4 W/120 OHM	SHIFT PLUG CPL 4 W/120 OHM
0950.000		292104087406		SHIFTSTECKER KPL 4W/220 OHM	SHIFT PLUG CPL 4W/220 OHM
1100.000		830003047400		BILDR.A66EAK554X44	PICT.TUBE A66EAK554X44
1110.000	△	292013601106		ANODENKAPPE M.HOCHSPANNUNGSKABEL	ANODE CAP W.HIGH VOLTAGE CABLE
1300.000		295017610104		BEDIENEINSATZ MONT.KPL	CONTROL INSERT MOUNT.CPL
1301.000		295017620302		KLAPPE DRUCK KPL	FLAP PRINT CPL
1353.000		270332210100		DRUCKSCHNAPPER	PRESSURE CATCH
1354.000		296380231301	2	DAEMPFBLOCK	DAMPING BLOCK
1370.000		295017612102		TASTENKNOPF NETZ	KEY KNOB POWER
1371.000		293033750802		DRUCKFEDER TASTENKNOPF NETZ	PRESSURE SPRING KEY KNOB POWER
2400.000		296420660300		TP 150 C FERNBEDIENUNG SCHWARZ	TP 150 C REMOTE CONTROL BLACK
		219169414700		BEDIENUNGSANLEITUNG D/NL	OPERATING INSTRUCTIONS D/NL
		720100305000		SERVICE MANUAL D/GB	SERVICE MANUAL D/GB
		720100305400		SERVICE MANUAL D/GB 4.ERGAENZUNG	SERVICE MANUAL D/GB 4TH SUPPLEMENT
		720100305500		SERVICE MANUAL D/GB 5.ERGAENZUNG	SERVICE MANUAL D/GB 5TH SUPPLEMENT
		720100305600		SERVICE MANUAL D/GB 6.ERGAENZUNG	SERVICE MANUAL D/GB 6TH SUPPLEMENT
		297040191300	X	CHASSIS-FS-STEREO CUC 1837 DIGI 100 KEIN E-TEIL	CHASSIS TV STEREO CUC 1837 DIGI 100 NO SPARE PART
				X=SIHE GESONDERTE E-LISTE	X=SEE SEPARATE PARTS LIST
				ALLE WEITEREN TEILE SIEHE E-LISTE ELEGANCE 70 ST 70-300 DOLBY TITANE MAT.-NR.: 921916219200 BESTELL-NR.: GCM8310 AUSGABE 4/2001 VERSION NR.: VNM	FOR ALL OTHER PARTS SEE ELEGANCE 70 ST 70-300 DOLBY TITANE PART NO.: 921916219200 ORDER NR.: GCM8310 EDITION 4/2001 VERSION NO.: VNM

ÄNDERUNGEN VORBEHALTEN / SUBJECT TO ALTERATION

POS. NR. MATERIAL-NR. BEZEICHNUNG  
POS. NO. PART NUMBER DESCRIPTION

POS. NR. MATERIAL-NR. BEZEICHNUNG  
POS. NO. PART NUMBER DESCRIPTION

### ELEGANCE 70 ST 70-300 DOLBY

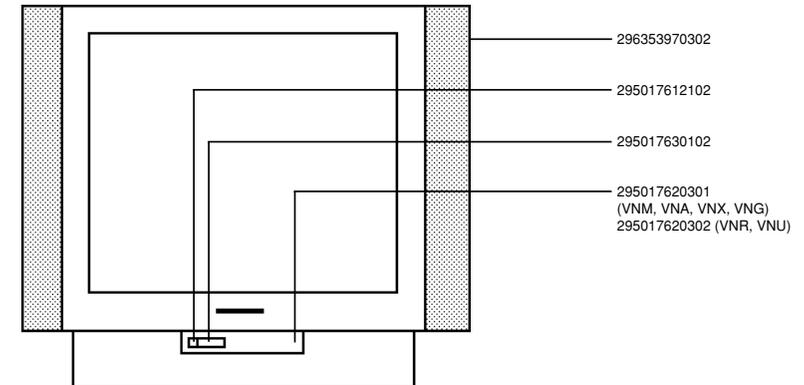

Es gelten die Vorschriften und Sicherheitshinweise gemäß dem Service Manual "Sicherheit", Mat.-Nummer 720108000000, sowie zusätzlich die eventuell abweichenden, landesspezifischen Vorschriften!



The regulations and safety instructions shall be valid as provided by the "Safety" Service Manual, part number 720108000000, as well as the respective national deviations.

ÄNDERUNGEN VORBEHALTEN / SUBJECT TO ALTERATION

## Ersatzteilliste Spare Parts List

### 1 / 2002

## ELEGANCE 70 ST 70-300 DOLBY

MATERIAL-NR. / PART NO.: 921916214000 BESTELL-NR. / ORDER NO.: GCM8320 PROCON SILBER/PROCON SILVER  
VERSION NR./VERSION NO.: VNX

POS. NR. POS. NO.	ABB. FIG.	MATERIAL-NR. PART NUMBER	ANZ. QTY.	BEZEICHNUNG D	DESCRIPTION GB
		921916214000		ELEGANCE 70 ST 70-300 DOLBY PROCON SILBER KEIN E-TEIL	ELEGANCE 70 ST 70-300 DOLBY PROCON SILVER NO SPARE PART
0050.000		297981113000		PROGRAMM FLASH-EPROM DOWNLOAD: WWW.GRUNDIG.DE/PRODUKTE/ KONTAKT/HAENDLERSERVICE	PROGRAM FLASH-EPROM DOWNLOAD: WWW.GRUNDIG.DE/PRODUCTS/ CONTACT/RESELLER SUPPORT
0200.000		296353970101		GEH-VORDETEIL DRUCK KPL	CABINET FRONT PART PRINT CPL
0201.000		191260359701	2	LAUTSPRECHER	LOUDSPEAKER
0203.000		297006510103		ABDECKUNG DIGI-100	COVER DIGI-100
0204.000		297006530101		ABDECKUNG FLASH	COVER FLASH
0225.000		295017620104		KLAPPE DRUCK KPL	FLAP PRINT CPL
0228.000		296088640102	5	SOCKELEINLAGE	BASE INSERT
0230.000		295017630102		IR-FENSTER	IR WINDOW
0300.000		296366070301		GEH-RUECKTEIL OFB	CABINET REAR PART SURFACE TREATED
0320.000		291103966502		TYPENAUFKLEBER VNX	TYPE LABEL SELF ADHESIVE VNX
0450.000		297006544101		HALTER LEITERPLATTE	HOLDER PCB
0700.000	△	092461317506		ENTMAGNETISIERUNGSSPULE	DEGAUSSING COIL
1100.000		830003043600		BILDROHR A 66 EAK075X44 PHILIPS	PICTURE TUBE A 66 EAK075X44 PHILIPS
1170.000		292104087100		SHIFTSTECKER KPL(4W/120 OHM)	SHIFT PLUG CPL (4W/120 OHM)
1170.000		292104087406		SHIFTSTECKER KPL(4W/220 OHM)	SHIFT PLUG CPL (4W/220 OHM)
1200.000	△	292013600211		ANODENKAPPE M.HOCHSPANNUNGSKABEL	ANODE CAP W.HIGH VOLTAGE CABLE
1300.000		295017610103		BEDIENEINSATZ MONTIERT KPL	CONTROL INSERT MOUNTED CPL
2000.000	△	829099131600		NETZKABEL KPL M.ENTSTOERDROSSEL	POWER CABLE W.INTERFERENCE CHOKE
2300.000		293051223100	X	BILDROHRPLATTE	PICTURE TUBE BOARD
2400.000		296420660400		TP 150 C FERNBEDIENUNG	TP 150 C REMOTE CONTROL
		219169414600		BEDIENUNGSANLEITUNG D/NL	OPERATING INSTRUCTIONS D/NL
		720100305000		SERVICE MANUAL D/GB	SERVICE MANUAL D/GB
2700.000		296364810102	4	BEFESTIGUNGS-EINSATZ	HOLDER INSERT
		296560040200		MONTAGEZUBEHOER F.BILDROHR KEIN E-TEIL	MOUNTING ACCESSORIES F.PICT. TUBE NO SPARE PART
		297040111200	X	CHASSIS-FS-STEREO DIGI 100 CUC 1837 KEIN E-TEIL	CHASSIS TV STEREO DIGI 100 CUC 1837 NO SPARE PART
				X = SIEHE GESONDERTE E-LISTE	X = SEE SEPARATE PARTS LIST

52

POS. NR. MATERIAL-NR. BEZEICHNUNG  
POS. NO. PART NUMBER DESCRIPTION

POS. NR. MATERIAL-NR. BEZEICHNUNG  
POS. NO. PART NUMBER DESCRIPTION

## ELEGANCE 70 ST 70-300 DOLBY

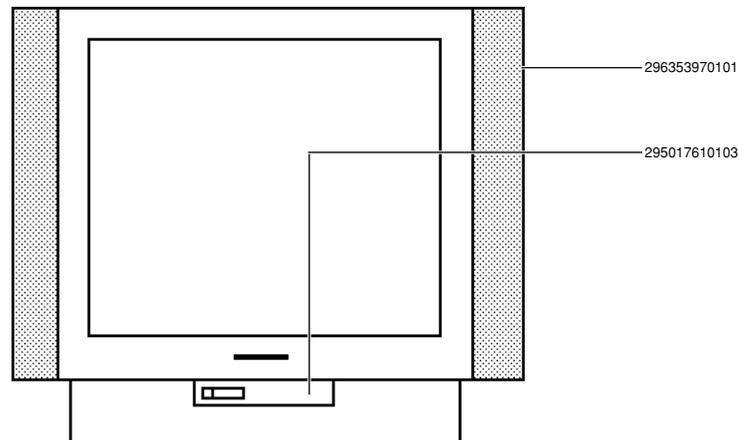

Es gelten die Vorschriften und Sicherheitshinweise gemäß dem Service Manual "Sicherheit", Mat.-Nummer 720108000000, sowie zusätzlich die eventuell abweichenden, landesspezifischen Vorschriften!



The regulations and safety instructions shall be valid as provided by the "Safety" Service Manual, part number 720108000000, as well as the respective national deviations.

ÄNDERUNGEN VORBEHALTEN / SUBJECT TO ALTERATION

ÄNDERUNGEN VORBEHALTEN / SUBJECT TO ALTERATION

#### 12 / 2001

#### ELEGANCE 70 ST 70-300 DOLBY

MATERIAL-NR. / PART NO.: 921916214000 BESTELL-NR. / ORDER NO.: GCM8320 PROCON SILBER/PROCON SILVER  
VERSION NR./VERSION NO.: **VNG**

POS. NR. POS. NO.	ABB. FIG.	MATERIAL-NR. PART NUMBER	ANZ. QTY.	BEZEICHNUNG (D)	DESCRIPTION (GB)
		921916214000		ELEGANCE 70 ST 70-300 DOLBY PROCON SILBER VNG KEIN E-TEIL	ELEGANCE 70 ST 70-300 DOLBY PROCON SILVER VNG NO SPARE PART
0050.000		297981113000		PROGRAMM FLASH-EPROM DOWNLOAD: WWW.GRUNDIG.DE/PRODUKTE/ KONTAKT/HAENDLERSERVICE	PROGRAM FLASH-EPROM DOWNLOAD: WWW.GRUNDIG.DE/PRODUCTS/ CONTACT/RESELLER SUPPORT
0320.000 1100.000 1200.000 2500.000	△	291104596601 830003047400 292013601106 219169414700		TYPENAUFKLEBER VNG BILDROHR A 66 EAK554X44PHILIPS ANODENKAPPE M.HOCHSPANNUNGSKABEL BEDIENUNGSANLEITUNG D/NL	TYPE LABEL SELF ADHESIVE VNG PICTURE TUBE A 66 EAK554X44 PHILIPS ANODE CAP W.HIGH VOLTAGE CABLE OPERATION INSTRUCTIONS D/NL
		297040112400	X	CHASSIS-FS-STEREO DIGI 100 CUC 1837 KEIN E-TEIL	CHASSIS TV STEREO DIGI 100 CUC 1837 NO SPARE PART
				X = SIEHE GESONDERTE E-LISTE	X = SEE SEPARATE PARTS LIST
				ALLE WEITEREN TEILE SIEHE E-LISTE ELEGANCE 70 ST 70-300 DOLBY MAT.-NR.: 921916214000 BESTELL-NR.: GCM8320 AUSGABE 12/2001 VERSION NR.: <b>VNX</b>	FOR ALL OTHER PARTS SEE ELEGANCE 70 ST 70-300 DOLBY PART NO.: 921916214000 ORDER NO.: GCM8320 EDITION 12/2001 VERSION NO.: <b>VNX</b>

#### 12 / 2001

#### ELEGANCE 70 ST 70-300 DOLBY

MATERIAL-NR. / PART NO.: 921916214000 BESTELL-NR. / ORDER NO.: GCM8320 PROCON SILBER/PROCON SILVER  
VERSION NR./VERSION NO.: **VNR**

POS. NR. POS. NO.	ABB. FIG.	MATERIAL-NR. PART NUMBER	ANZ. QTY.	BEZEICHNUNG (D)	DESCRIPTION (GB)
		921916214000		ELEGANCE 70 ST 70-300 DOLBY PROCON SILBER VNR KEIN E-TEIL	ELEGANCE 70 ST 70-300 DOLBY PROCON SILVER VNR NO SPARE PART
0050.000		297981113000		PROGRAMM FLASH-EPROM DOWNLOAD: WWW.GRUNDIG.DE/PRODUKTE/ KONTAKT/HAENDLERSERVICE	PROGRAM FLASH-EPROM DOWNLOAD: WWW.GRUNDIG.DE/PRODUCTS/ CONTACT/RESELLER SUPPORT
0320.000		291103966702		TYPENAUFKLEBER VNR	TYPE LABEL SELF ADHESIVE VNR
		297040191800	X	CHASSIS-FS-STEREO DIGI 100 CUC 1837 KEIN E-TEIL	CHASSIS TV STEREO DIGI 100 CUC 1837 NO SPARE PART
				X = SIEHE GESONDERTE E-LISTE	X = SEE SEPARATE PARTS LIST
				ALLE WEITEREN TEILE SIEHE E-LISTE ELEGANCE 70 ST 70-300 DOLBY MAT.-NR.: 921916214000 BESTELL-NR.: GCM8320 AUSGABE 12/2001 VERSION NR.: <b>VNX</b>	FOR ALL OTHER PARTS SEE ELEGANCE 70 ST 70-300 DOLBY PART NO.: 921916214000 ORDER NO.: GCM8320 EDITION 12/2001 VERSION NO.: <b>VNX</b>

Es gelten die Vorschriften und Sicherheitshinweise gemäß dem Service Manual "Sicherheit", Mat.-Nummer 720108000000, sowie zusätzlich die eventuell abweichenden, landesspezifischen Vorschriften!



The regulations and safety instructions shall be valid as provided by the "Safety" Service Manual, part number 720108000000, as well as the respective national deviations.

ÄNDERUNGEN VORBEHALTEN / SUBJECT TO ALTERATION

Es gelten die Vorschriften und Sicherheitshinweise gemäß dem Service Manual "Sicherheit", Mat.-Nummer 720108000000, sowie zusätzlich die eventuell abweichenden, landesspezifischen Vorschriften!



The regulations and safety instructions shall be valid as provided by the "Safety" Service Manual, part number 720108000000, as well as the respective national deviations.

ÄNDERUNGEN VORBEHALTEN / SUBJECT TO ALTERATION

GRUNDIG

TV

Ersatzteilliste  
Spare Parts List

12 / 2001

ELEGANCE 70 ST 70-300 DOLBY

MATERIAL-NR. / PART NO.: 921916214000 BESTELL-NR. / ORDER NO.: GCM8320 PROCON SILBER/PROCON SILVER  
VERSION NR./VERSION NO.: VNU

POS. NR. POS. NO.	ABB. FIG.	MATERIAL-NR. PART NUMBER	ANZ. QTY.	BEZEICHNUNG (D)	DESCRIPTION (GB)
		921916214000		ELEGANCE 70 ST 70-300 DOLBY PROCON SILBER VNU KEIN E-TEIL	ELEGANCE 70 ST 70-300 DOLBY PROCON SILVER VNU NO SPARE PART
0050.000		297981113000		PROGRAMM FLASH-EPROM DOWNLOAD: WWW.GRUNDIG.DE/PRODUKTE/ KONTAKT/HAENDLERSERVICE	PROGRAM FLASH-EPROM DOWNLOAD: WWW.GRUNDIG.DE/PRODUCTS/ CONTACT/RESELLER SUPPORT
0320.000 1100.000 1200.000 2500.000	△	291104596801 830003047400 292013601106 219169414700		TYPENAUFKLEBER VNU BILDROHR A 66 EAK554X44 PHILIPS ANODENKAPPE M.HOCHSPANNUNGSKABEL BEDIENUNGSANLEITUNG D/NL	TYPE LABEL SELF ADHESIVE VNU PICTURE TUBE A 66 EAK554X44 PHILIPS ANODE CAP W.HIGH VOLTAGE CABLE OPERATION INSTRUCTIONS D/NL
		297040191300	X	CHASSIS-FS-STEREO DIGI 100 CUC 1837 KEIN E-TEIL  X = SIEHE GESONDERTE E-LISTE	CHASSIS TV STEREO DIGI 100 CUC 1837 NO SPARE PART  X = SEE SEPARATE PARTS LIST
				ALLE WEITEREN TEILE SIEHE E-LISTE ELEGANCE 70 ST 70-300 DOLBY MAT.-NR.: 921916214000 BESTELL-NR.: GCM8320 AUSGABE 12/2001 VERSION NR.: VNX	FOR ALL OTHER PARTS SEE ELEGANCE 70 ST 70-300 DOLBY PART NO.: 921916214000 ORDER NO.: GCM8320 EDITION 12/2001 VERSION NO.: VNX

GRUNDIG

TV

Ersatzteilliste  
Spare Parts List

7 / 2002

ELEGANCE 70 ST 70-300/8 DOLBY

MATERIAL-NR. / PART NO.: 921916026900 BESTELL-NR. / ORDER NO.: GCL0600 TESSA BLACK  
VERSION NR./VERSION NO.: VNX

POS. NR. POS. NO.	ABB. FIG.	MATERIAL-NR. PART NUMBER	ANZ. QTY.	BEZEICHNUNG (D)	DESCRIPTION (GB)
		921916026900		ELEGANCE 70 ST 70-300/8 DOLBY TESSA BLACK KEIN E-TEIL	ELEGANCE 70 ST 70-300/8 DOLBY TESSA BLACK NO SPARE PART
0050.000				PROGRAMM FLASH-EPROM DOWNLOAD: WWW.GRUNDIG.DE/ PRODUKTE/KONTAKT/HAENDLERSERVICE	PROGRAM FLASH EPROM DOWNLOAD: WWW.GRUNDIG.DE/ PRODUCTS/CONTACT/RESELLER SUPPORT
0312.000 0320.000 0700.000 0950.000 0950.000	△	297006510103 291102766503 092461317506 292104087100 292104087406		ABDECKUNG DIGI-100 TYPENAUFKLEBER VNX ENTMAGNETISIERUNGSSPULE M.HALTER SHIFTSTECKER KPL 4 W/120 OHM SHIFTSTECKER KPL 4W/220 OHM	COVER DIGI-100 TYPE LABEL VNX DEGAUSSING COIL W.HOLDER SHIFT PLUG CPL 4 W/120 OHM SHIFT PLUG CPL 4W/220 OHM
1300.000		295017610103		BEDIENEINSATZ MONT.KPL	CONTROL INSERT MOUNT.CPL
2400.000 2410.000		296420660300 720086745000		TP 150 C FERNBEDIENUNG SCHWARZ DECKEL BATTERIE TP 150 C	TP 150 C REMOTE CONTROL BLACK BATTERY LID TP 150 C
		219169413300 219169413400 219169413500 219169413600 219169413700 219169413800 720100305000 720100305400 720100305500 720100305600		BEDIENUNGSANLEITUNG D BEDIENUNGSANLEITUNG F/I BEDIENUNGSANLEITUNG E/P BEDIENUNGSANLEITUNG S/N BEDIENUNGSANLEITUNG DK/FIN BEDIENUNGSANLEITUNG GB/NL SERVICE MANUAL D/GB SERVICE MANUAL D/GB 4.ERGAENZUNG SERVICE MANUAL D/GB 5.ERGAENZUNG SERVICE MANUAL D/GB 6.ERGAENZUNG	OPERATING INSTRUCTIONS D OPERATING INSTRUCTIONS F/I OPERATING INSTRUCTIONS E/P OPERATING INSTRUCTIONS S/N OPERATING INSTRUCTIONS DK/FIN OPERATING INSTRUCTIONS GB/NL SERVICE MANUAL D/GB SERVICE MANUAL D/GB 4TH SUPPLEMENT SERVICE MANUAL D/GB 5TH SUPPLEMENT SERVICE MANUAL D/GB 6TH SUPPLEMENT
				ALLE WEITEREN TEILE SIEHE E-LISTE ELEGANCE 70 ST 70-300/8 DOLBY TESSA BLACK MAT.-NR.: 921916026900 BESTELL-NR.: GCL0600 AUSGABE 11/2000 VERSION NR.: VNM	FOR ALL OTHER PARTS SEE ELEGANCE 70 ST 70-300/8 DOLBY TESSA BLACK PART NO: 921916026900 ORDER NR: GCL0600 EDITION 11/2000 VERSION NO.: VNM

Es gelten die Vorschriften und Sicherheitshinweise gemäß dem Service Manual "Sicherheit", Mat.-Nummer 720108000000, sowie zusätzlich die eventuell abweichenden, landesspezifischen Vorschriften!



The regulations and safety instructions shall be valid as provided by the "Safety" Service Manual, part number 720108000000, as well as the respective national deviations.

ÄNDERUNGEN VORBEHALTEN / SUBJECT TO ALTERATION

Es gelten die Vorschriften und Sicherheitshinweise gemäß dem Service Manual "Sicherheit", Mat.-Nummer 720108000000, sowie zusätzlich die eventuell abweichenden, landesspezifischen Vorschriften!



The regulations and safety instructions shall be valid as provided by the "Safety" Service Manual, part number 720108000000, as well as the respective national deviations.

ÄNDERUNGEN VORBEHALTEN / SUBJECT TO ALTERATION

## Ersatzteilliste Spare Parts List

### 7 / 2002

### ELEGANCE 70 ST 70-300/8 DOLBY

MATERIAL-NR. / PART NO.: 921916024000 BESTELL-NR. / ORDER NO.: GCL0642 PROCON SILBER/PROCON SILVER  
VERSION NR./VERSION NO.: VNX

POS. NR. POS. NO.	ABB. FIG.	MATERIAL-NR. PART NUMBER	ANZ. QTY.	BEZEICHNUNG (D)	DESCRIPTION (GB)
		921916024000		ELEGANCE 70 ST 70-300/8 DOLBY PROCON SILBER KEIN E-TEIL	ELEGANCE 70 ST 70-300/8 DOLBY PROCON SILVER NO SPARE PART
0050.000				PROGRAMM FLASH-EPROM DOWNLOAD: WWW.GRUNDIG.DE/ PRODUKTE/KONTAKT/HAENDLERSERVICE	PROGRAM FLASH EPROM DOWNLOAD: WWW.GRUNDIG.DE/ PRODUCTS/CONTACT/RESELLER SUPPORT
0300.000		296366070301		GEH-RUECKTEIL OFB	CABINET REAR PART SURFACE TREATED
0320.000		291102766503		TYPENAUFKLEBER VNX	TYPE LABEL VNX
0700.000	△	092461317506		ENTMAGNETISIERUNGSSPULE M.HALTER	DEGAUSSING COIL W.HOLDER
0950.000		292104087100		SHIFTSTECKER KPL 4 W/120 OHM	SHIFT PLUG CPL 4 W/120 OHM
0950.000		292104087406		SHIFTSTECKER KPL 4W/220 OHM	SHIFT PLUG CPL 4W/220 OHM
1300.000		295017610103		BEDIENEINSATZ MONT.KPL	CONTROL INSERT MOUNT.CPL
2400.000		296420660400		TP 150 C FERNBEDIENUNG GRAU	TP 150 C REMOTE CONTROL GREY
2410.000		720086745100		DECKEL BATTERIE TP 150 C	BATTERY LID TP 150 C
		219169413300		BEDIENUNGSANLEITUNG D	OPERATING INSTRUCTIONS D
		219169413400		BEDIENUNGSANLEITUNG F/I	OPERATING INSTRUCTIONS F/I
		219169413500		BEDIENUNGSANLEITUNG E/P	OPERATING INSTRUCTIONS E/P
		219169413600		BEDIENUNGSANLEITUNG S/N	OPERATING INSTRUCTIONS S/N
		219169413700		BEDIENUNGSANLEITUNG DK/FIN	OPERATING INSTRUCTIONS DK/FIN
		219169413800		BEDIENUNGSANLEITUNG GB/NL	OPERATING INSTRUCTIONS GB/NL
		720100305000		SERVICE MANUAL D/GB	SERVICE MANUAL D/GB
		720100305400		SERVICE MANUAL D/GB 4.ERGAENZUNG	SERVICE MANUAL D/GB 4TH SUPPLEMENT
		720100305500		SERVICE MANUAL D/GB 5.ERGAENZUNG	SERVICE MANUAL D/GB 5TH SUPPLEMENT
		720100305600		SERVICE MANUAL D/GB 6.ERGAENZUNG	SERVICE MANUAL D/GB 6TH SUPPLEMENT
				ALLE WEITEREN TEILE SIEHE E-LISTE ELEGANCE 70 ST 70-300/8 DOLBY PROCON SILBER MAT.-NR.: 921916024000 BESTELL-NR.: GCL0642 AUSGABE 11/2000 VERSION NR.: VNM	FOR ALL OTHER PARTS SEE ELEGANCE 70 ST 70-300/8 DOLBY PROCON SILVER PART NO: 921916024000 ORDER NR: GCL0642 EDITION 11/2000 VERSION NO.: VNM

POS. NR. MATERIAL-NR. BEZEICHNUNG  
POS. NO. PART NUMBER DESCRIPTION

POS. NR. MATERIAL-NR. BEZEICHNUNG  
POS. NO. PART NUMBER DESCRIPTION

### ELEGANCE 70 ST 70-300/8 DOLBY

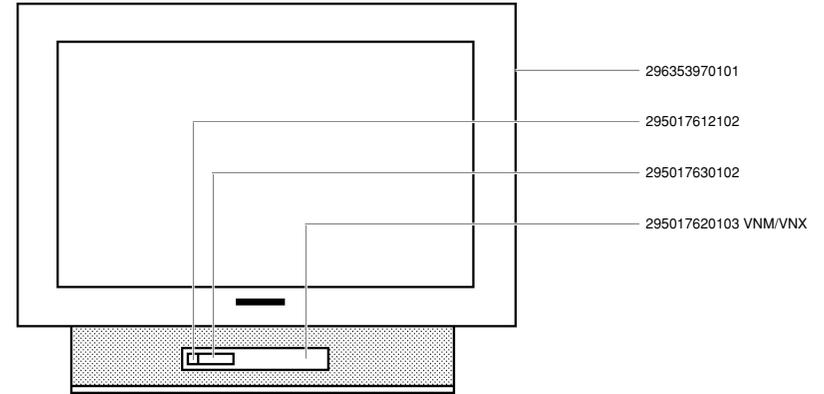

Es gelten die Vorschriften und Sicherheitshinweise gemäß dem Service Manual "Sicherheit", Mat.-Nummer 720108000000, sowie zusätzlich die eventuell abweichenden, landesspezifischen Vorschriften!



The regulations and safety instructions shall be valid as provided by the "Safety" Service Manual, part number 720108000000, as well as the respective national deviations.

### ELEGANCE 70 ST 70-300/8 DOLBY

MATERIAL-NR. / PART NO.: 921916024000 BESTELL-NR. / ORDER NO.: GCL0642 PROCON SILBER/PROCON SILVER  
VERSION NR./VERSION NO.: VNR

POS. NR. POS. NO.	ABB. FIG.	MATERIAL-NR. PART NUMBER	ANZ. QTY.	BEZEICHNUNG (D)	DESCRIPTION (GB)
		921916024000		ELEGANCE 70 ST 70-300/8 DOLBY PROCON SILBER KEIN E-TEIL	ELEGANCE 70 ST 70-300/8 DOLBY PROCON SILVER NO SPARE PART
0050.000				PROGRAMM FLASH-EPROM DOWNLOAD: WWW.GRUNDIG.DE/ PRODUKTE/KONTAKT/HAENDLERSERVICE	PROGRAM FLASH EPROM DOWNLOAD: WWW.GRUNDIG.DE/ PRODUCTS/CONTACT/RESELLER SUPPORT
0300.000		296366070301		GEH-RUECKTEIL OFB	CABINET REAR PART SURFACE TREATED
0312.000		297006510104		ABDECKUNG DIGI-100	COVER DIGI-100
0320.000		291102766703		TYPENAUFKLEBER VNR	TYPE LABEL VNR
0700.000	△	092461317507		ENTMAGNETISIERUNGSSPULE M.HALTER	DEGAUSSING COIL W.HOLDER
0950.000		292104087100		SHIFTSTECKER KPL 4 W/120 OHM	SHIFT PLUG CPL 4 W/120 OHM
0950.000		292104087406		SHIFTSTECKER KPL 4W/220 OHM	SHIFT PLUG CPL 4W/220 OHM
1300.000		295017610104		BEDIENEINSATZ MONT.KPL	CONTROL INSERT MOUNT.CPL
1301.000		295017620104		KLAPPE DRUCK KPL	FLAP PRINT CPL
2400.000		296420660400		TP 150 C FERNBEDIENUNG GRAU	TP 150 C REMOTE CONTROL GREY
2410.000		720086745100		DECKEL BATTERIE TP 150 C	BATTERY LID TP 150 C
		219169413300		BEDIENUNGSANLEITUNG D	OPERATING INSTRUCTIONS D
		219169413400		BEDIENUNGSANLEITUNG F/I	OPERATING INSTRUCTIONS F/I
		219169413500		BEDIENUNGSANLEITUNG E/P	OPERATING INSTRUCTIONS E/P
		219169413600		BEDIENUNGSANLEITUNG S/N	OPERATING INSTRUCTIONS S/N
		219169413700		BEDIENUNGSANLEITUNG DK/FIN	OPERATING INSTRUCTIONS DK/FIN
		219169413800		BEDIENUNGSANLEITUNG GB/NL	OPERATING INSTRUCTIONS GB/NL
		720100305000		SERVICE MANUAL D/GB	SERVICE MANUAL D/GB
		720100305400		SERVICE MANUAL D/GB 4.ERGAENZUNG	SERVICE MANUAL D/GB 4TH SUPPLEMENT
		720100305500		SERVICE MANUAL D/GB 5.ERGAENZUNG	SERVICE MANUAL D/GB 5TH SUPPLEMENT
		720100305600		SERVICE MANUAL D/GB 6.ERGAENZUNG	SERVICE MANUAL D/GB 6TH SUPPLEMENT
		297040191900	X	CHASSIS-FS-STEREO CUC 1837 DIDGI 100 KEIN E-TEIL	CHASSIS TV STEREO CUC 1837 DIDGI 100 NO SPARE PART
				ALLE WEITEREN TEILE SIEHE E-LISTE ELEGANCE 70 ST 70-300/8 DOLBY PROCON SILBER MAT.-NR.: 921916024000 BESTELL-NR.: GCL0642 AUSGABE 11/2000 VERSION NR.: VNM	FOR ALL OTHER PARTS SEE ELEGANCE 70 ST 70-300/8 DOLBY PROCON SILVER PART NO.: 921916024000 ORDER NR.: GCL0642 EDITION 11/2000 VERSION NO.: VNM

### ELEGANCE 70 ST 70-300/8 DOLBY

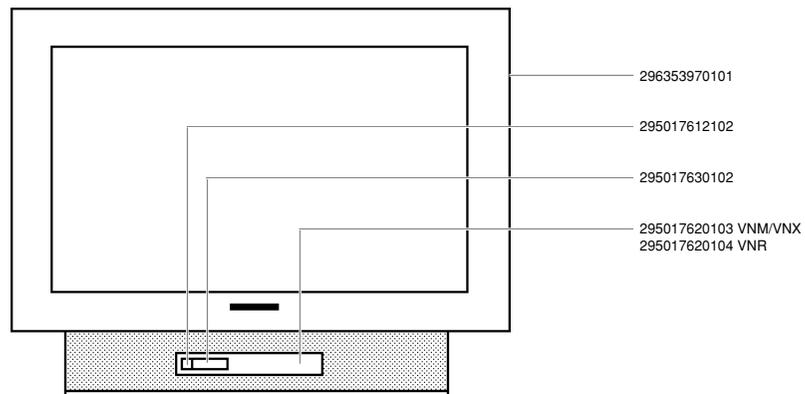

POS. NR. MATERIAL-NR. BEZEICHNUNG  
POS. NO. PART NUMBER DESCRIPTION

POS. NR. MATERIAL-NR. BEZEICHNUNG  
POS. NO. PART NUMBER DESCRIPTION

Es gelten die Vorschriften und Sicherheitshinweise gemäß dem Service Manual "Sicherheit", Mat.-Nummer 720108000000, sowie zusätzlich die eventuell abweichenden, landesspezifischen Vorschriften!



The regulations and safety instructions shall be valid as provided by the "Safety" Service Manual, part number 720108000000, as well as the respective national deviations.

ÄNDERUNGEN VORBEHALTEN / SUBJECT TO ALTERATION

ÄNDERUNGEN VORBEHALTEN / SUBJECT TO ALTERATION

Ersatzteilliste  
Spare Parts List

7 / 2002

## ELEGANCE 70 ST 70-300/8 DOLBY

MATERIAL-NR. / PART NO.: 921916029200 BESTELL-NR. / ORDER NO.: GCL0692 TITANE  
VERSION NR./VERSION NO.: VNX

POS. NR. POS. NO.	ABB. FIG.	MATERIAL-NR. PART NUMBER	ANZ. QTY.	BEZEICHNUNG (D)	DESCRIPTION (GB)
		921916029200		ELEGANCE 70 ST 70-300/8 DOLBY TITANE KEIN E-TEIL	ELEGANCE 70 ST 70-300/8 DOLBY TITANE NO SPARE PART
0050.000				PROGRAMM FLASH-EPROM DOWNLOAD: WWW.GRUNDIG.DE/ PRODUKTE/KONTAKT/HAENDLERSERVICE	PROGRAM FLASH EPROM DOWNLOAD: WWW.GRUNDIG.DE/ PRODUCTS/CONTACT/RESELLER SUPPORT
0312.000		297006510103		ABDECKUNG DIGI-100	COVER DIGI-100
0320.000		291102766503		TYPENAUFKLEBER VNX	TYPE LABEL VNX
0950.000		292104087100		SHIFTSTECKER KPL 4 W/120 OHM	SHIFT PLUG CPL 4 W/120 OHM
1100.000		292104087406		SHIFTSTECKER KPL 4W/220 OHM	SHIFT PLUG CPL 4W/220 OHM
1100.000		830003043600		BILDR.A66EAK075X44 PHILIPS	PICT.TUBE A66EAK075X44 PHILIPS
1110.000	△	2920113600211		ANODENKAPPE M.HOCHSPANNUNGSKABEL	ANODE CAP W.HIGH VOLTAGE CABLE
1300.000		295017610103		BEDIENEINSATZ MONT.KPL	CONTROL INSERT MOUNT.CPL
1353.000		270332210100		DRUCKSCHNAPPER KLAPPE	PRESSURE CATCH FLAP
1354.000		296380231301	2	DAEMPFBLOCK	DAMPING BLOCK
1370.000		295017612102		TASTENKNOPF NETZ	KEY KNOB POWER
1371.000		293033750802		DRUCKFEDER TASTENKNOPF NETZ	PRESSURE SPRING KEY KNOB POWER
2400.000		296420660300		TP 150 C FERNBEDIENUNG SCHWARZ	TP 150 C REMOTE CONTROL BLACK
2410.000		720086745000		DECKEL BATTERIE TP 150 C	BATTERY LID TP 150 C
		219169413300		BEDIENUNGSANLEITUNG D	OPERATING INSTRUCTIONS D
		219169413400		BEDIENUNGSANLEITUNG F/I	OPERATING INSTRUCTIONS F/I
		219169413500		BEDIENUNGSANLEITUNG E/P	OPERATING INSTRUCTIONS E/P
		219169413600		BEDIENUNGSANLEITUNG S/N	OPERATING INSTRUCTIONS S/N
		219169413700		BEDIENUNGSANLEITUNG DK/FIN	OPERATING INSTRUCTIONS DK/FIN
		219169413800		BEDIENUNGSANLEITUNG GB/NL	OPERATING INSTRUCTIONS GB/NL
		720100305000		SERVICE MANUAL D/GB	SERVICE MANUAL D/GB
		720100305400		SERVICE MANUAL D/GB 4.ERGAENZUNG	SERVICE MANUAL D/GB 4TH SUPPLEMENT
		720100305500		SERVICE MANUAL D/GB 5.ERGAENZUNG	SERVICE MANUAL D/GB 5TH SUPPLEMENT
		720100305600		SERVICE MANUAL D/GB 6.ERGAENZUNG	SERVICE MANUAL D/GB 6TH SUPPLEMENT
		297040111300	X	CHASSIS-FS-STEREO CUC 1837 DIDGI 100 KEIN E-TEIL	CHASSIS TV STEREO CUC 1837 DIDGI 100 NO SPARE PART
				X=SIEHE GESONDERTE E-LISTE	X=SEE SEPARATE PARTS LIST
				ALLE WEITEREN TEILE SIEHE E-LISTE ELEGANCE 70 ST 70-300/8 DOLBY TITANE MAT.-NR.: 921916029200 BESTELL-NR.: GCL0692 AUSGABE 5/2001 VERSION NR.: VNM	FOR ALL OTHER PARTS SEE ELEGANCE 70 ST 70-300/8 DOLBY TITANE PART NO.: 921916029200 ORDER NR.: GCL0692 EDITION 5/2001 VERSION NO.: VNM

ÄNDERUNGEN VORBEHALTEN / SUBJECT TO ALTERATION

POS. NR. MATERIAL-NR. BEZEICHNUNG  
POS. NO. PART NUMBER DESCRIPTIONPOS. NR. MATERIAL-NR. BEZEICHNUNG  
POS. NO. PART NUMBER DESCRIPTION

## ELEGANCE 70 ST 70-300/8 DOLBY

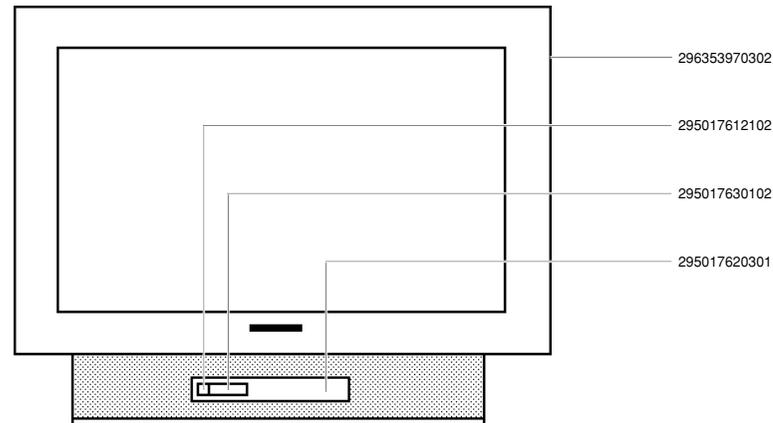
Es gelten die Vorschriften und Sicherheitshinweise  
gemäß dem Service Manual "Sicherheit", Mat.-Num-  
mer 720108000000, sowie zusätzlich die eventuell ab-  
weichenden, landesspezifischen Vorschriften!The regulations and safety instructions shall be valid  
as provided by the "Safety" Service Manual, part  
number 720108000000, as well as the respective  
national deviations.

ÄNDERUNGEN VORBEHALTEN / SUBJECT TO ALTERATION

## Ersatzteilliste Spare Parts List

### 7 / 2002

### ELEGANCE 70 ST 70-300/8 DOLBY

MATERIAL-NR. / PART NO.: 921916029200 BESTELL-NR. / ORDER NO.: GCL0692 TITANE  
VERSION NR./VERSION NO.: VNR

POS. NR. POS. NO.	ABB. FIG.	MATERIAL-NR. PART NUMBER	ANZ. QTY.	BEZEICHNUNG (D)	DESCRIPTION (GB)
		921916029200		ELEGANCE 70 ST 70-300/8 DOLBY TITANE KEIN E-TEIL	ELEGANCE 70 ST 70-300/8 DOLBY TITANE NO SPARE PART
0050.000				PROGRAMM FLASH-EPROM DOWNLOAD: WWW.GRUNDIG.DE/ PRODUKTE/KONTAKT/HAENDLERSERVICE	PROGRAM FLASH EPROM DOWNLOAD: WWW.GRUNDIG.DE/ PRODUCTS/CONTACT/RESELLER SUPPORT
0312.000 0320.000 0700.000 0950.000 0950.000 1100.000 1110.000	$\Delta$ $\Delta$ $\Delta$ $\Delta$ $\Delta$ $\Delta$	297006510104 291102766703 092461317507 292104087100 292104087406 830003043600 292013600211		ABDECKUNG DIGI-100 TYPENAUFKLEBER VNR ENTMAGNETISIERUNGSSPULE M.HALTER SHIFTSTECKER KPL 4 W/120 OHM SHIFTSTECKER KPL 4W/220 OHM BILDR.A66EAK075X44 PHILIPS ANODENKAPPE M.HOCHSPANNUNGSKABEL	COVER DIGI-100 TYPE LABEL VNR DEGAUSSING COIL W.HOLDER SHIFT PLUG CPL 4 W/120 OHM SHIFT PLUG CPL 4W/220 OHM PICT.TUBE A66EAK075X44 PHILIPS ANODE CAP W.HIGH VOLTAGE CABLE
1300.000 1301.000 1353.000 1354.000 1370.000 1371.000		295017610104 295017620302 270332210100 296380231301 295017612102 293033750802	2	BEDIENEINSATZ MONT.KPL KLAPPE DRUCK KPL DRUCKSCHNAPPEPPEP KLASPE DAEMPFBLOCK TASTENKNOPF NETZ DRUCKFEDER TASTENKNOPF NETZ	CONTROL INSERT MOUNT.CPL FLAP PRINT CPL PRESSURE CATCH FLAP DAMPING BLOCK KEY KNOB POWER PRESSURE SPRING KEY KNOB POWER
2400.000 2410.000		296420660300 720086745000		TP 150 C FERNBEDIENUNG SCHWARZ DECKEL BATTERIE TP 150 C	TP 150 C REMOTE CONTROL BLACK BATTERY LID TP 150 C
219169413300 219169413400 219169413500 219169413600 219169413700 219169413800 720100305000 720100305400 720100305500 720100305600				BEDIENUNGSANLEITUNG D BEDIENUNGSANLEITUNG F/I BEDIENUNGSANLEITUNG E/P BEDIENUNGSANLEITUNG S/N BEDIENUNGSANLEITUNG DK/FIN BEDIENUNGSANLEITUNG GB/NL SERVICE MANUAL D/GB SERVICE MANUAL D/GB 4.ERGAENZUNG SERVICE MANUAL D/GB 5.ERGAENZUNG SERVICE MANUAL D/GB 6.ERGAENZUNG	OPERATING INSTRUCTIONS D OPERATING INSTRUCTIONS F/I OPERATING INSTRUCTIONS E/P OPERATING INSTRUCTIONS S/N OPERATING INSTRUCTIONS DK/FIN OPERATING INSTRUCTIONS GB/NL SERVICE MANUAL D/GB SERVICE MANUAL D/GB 4TH SUPPLEMENT SERVICE MANUAL D/GB 5TH SUPPLEMENT SERVICE MANUAL D/GB 6TH SUPPLEMENT
297040191900			X	CHASSIS-FS-STEREO CUC 1837 DIDGI 100 KEIN E-TEIL  X=SIEHE GESONDERTE E-LISTE  ALLE WEITEREN TEILE SIEHE E-LISTE ELEGANCE 70 ST 70-300/8 DOLBY TITANE MAT.-NR.: 921916029200 BESTELL-NR.: GCL0692 AUSGABE 5/2001 VERSION NR.: VNM	CHASSIS TV STEREO CUC 1837 DIDGI 100 NO SPARE PART  X=SEE SEPARATE PARTS LIST  FOR ALL OTHER PARTS SEE ELEGANCE 70 ST 70-300/8 DOLBY TITANE PART NO: 921916029200 ORDER NR: GCL0692 EDITION 5/2001 VERSION NO.: VNM

ÄNDERUNGEN VORBEHALTEN / SUBJECT TO ALTERATION

POS. NR. MATERIAL-NR. BEZEICHNUNG  
POS. NO. PART NUMBER DESCRIPTION

POS. NR. MATERIAL-NR. BEZEICHNUNG  
POS. NO. PART NUMBER DESCRIPTION

### ELEGANCE 70 ST 70-300/8 DOLBY

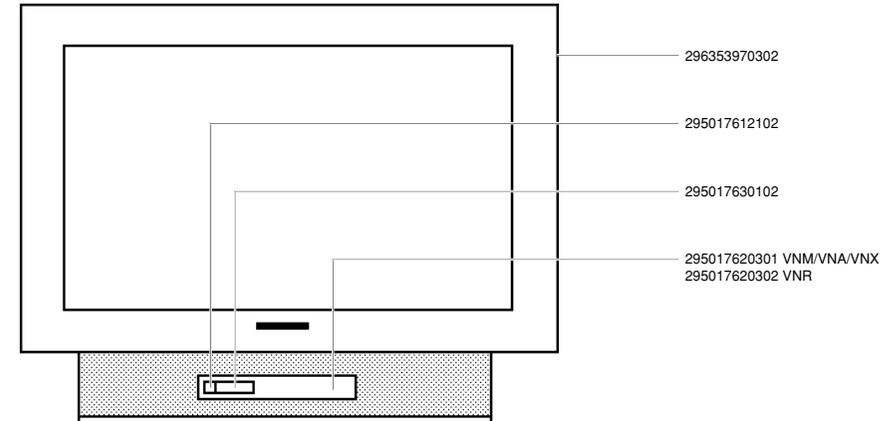

Es gelten die Vorschriften und Sicherheitshinweise gemäß dem Service Manual "Sicherheit", Mat.-Nummer 720108000000, sowie zusätzlich die eventuell abweichenden, landesspezifischen Vorschriften!



The regulations and safety instructions shall be valid as provided by the "Safety" Service Manual, part number 720108000000, as well as the respective national deviations.

ÄNDERUNGEN VORBEHALTEN / SUBJECT TO ALTERATION

## Ersatzteilliste Spare Parts List

### TV

### 6 / 2002

### ST 70-398 DOLBY

MATERIAL-NR. / PART NO.: 921983017500 BESTELL-NR. / ORDER NO.: GCM3300 SCHWARZ/BLACK  
VERSION NR./VERSION NO.: VNA

POS. NR. POS. NO.	ABB. FIG.	MATERIAL-NR. PART NUMBER	ANZ. QTY.	BEZEICHNUNG ①	DESCRIPTION ②
		921983017500		ST 70-398 DOLBY SCHWARZ KEIN E-TEIL	ST 70-398 DOLBY BLACK NO SPARE PART
0215.000		295017590104		RAHMEN M.TASTENKNOPF KPL	FRAME W.KEY KNOB CPL
0312.000		297006530101		ABDECKUNG FLASH	COVER FLASH
0320.000		291104286403		TYPENAUFKLEBER VNA	TYPE LABEL SELF ADHESIVE VNA
0700.000	△	092461317507		ENTMAGNETISIERUNGSSPULE	DEGAUSSING COIL
0950.000		292104087100		SHIFTSTECKER KPL 4W/120 OHM	SHIFT PLUG CPL 4W/120 OHM
0950.000		292104087406		SHIFTSTECKER KPL 4W/220 OHM	SHIFT PLUG CPL 4W/220 OHM
2400.000		296420660300		TP 150 C FERNBEDIENUNG	TP 150 C REMOTE CONTROL
2410.000		720086745000		DECKEL BATTERIE	BATTERY LID
		219839410100		BEDIENUNGSANLEITUNG D/I	OPERATION INSTRUCTIONS D/I
		720100305000		SERVICE MANUAL D/GB	SERVICE MANUAL D/GB
		720100305400		SERVICE MANUAL D/GB 4.ERGAENZUNG	SERVICE MANUAL D/GB 4TH SUPPLEMENT
		720100305500		SERVICE MANUAL D/GB 5.ERGAENZUNG	SERVICE MANUAL D/GB 5TH SUPPLEMENT
		720100305600		SERVICE MANUAL D/GB 6.ERGAENZUNG	SERVICE MANUAL D/GB 6TH SUPPLEMENT
				ALLE ANDEREN TEILE SIEHE E-LISTE ST 70-398 DOLBY MAT.-NR.: 921983017500 BESTELL-NR.: GCM3300 AUSGABE 1/2001 VERSION-NR.: VNM	FOR ALL OTHER PARTS SEE ST 70-398 DOLBY PART NO.: 921983017500 ORDER NO.: GCM3300 EDITION 1/2001 VERSION NO.: VNM

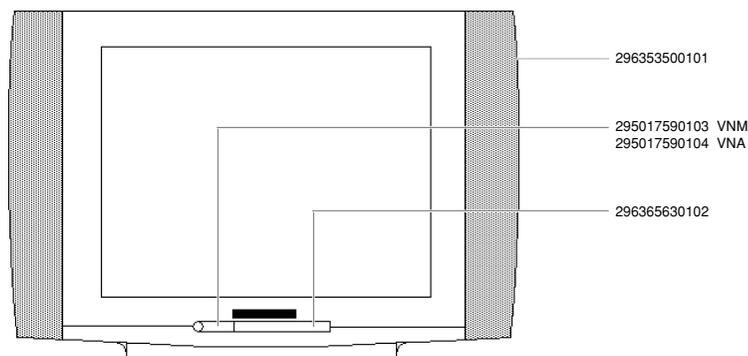

Es gelten die Vorschriften und Sicherheitshinweise gemäß dem Service Manual "Sicherheit", Mat.-Nummer 720108000000, sowie zusätzlich die eventuell abweichenden, landesspezifischen Vorschriften!



The regulations and safety instructions shall be valid as provided by the "Safety" Service Manual, part number 720108000000, as well as the respective national deviations.

ÄNDERUNGEN VORBEHALTEN / SUBJECT TO ALTERATION

## Ersatzteilliste Spare Parts List

### TV

### 6 / 2002

### ST 70-398 DOLBY

MATERIAL-NR. / PART NO.: 921983017500 BESTELL-NR. / ORDER NO.: GCM3300 SCHWARZ/BLACK  
VERSION NR./VERSION NO.: VNX

POS. NR. POS. NO.	ABB. FIG.	MATERIAL-NR. PART NUMBER	ANZ. QTY.	BEZEICHNUNG ①	DESCRIPTION ②
		921983017500		ST 70-398 DOLBY SCHWARZ KEIN E-TEIL	ST 70-398 DOLBY BLACK NO SPARE PART
0215.000		295017590105		RAHMEN M.TASTENKNOPF KPL	FRAME W.KEY KNOB CPL
0300.000		296319810901		GEH-RUECKTEIL OFB	CABINET REAR PART SURFACE TREATED
0320.000		291104286503		TYPENAUFKLEBER VNX	TYPE LABEL SELF ADHESIVE VNX
0700.000	△	092461317507		ENTMAGNETISIERUNGSSPULE	DEGAUSSING COIL
0950.000		292104087100		SHIFTSTECKER KPL 4W/120 OHM	SHIFT PLUG CPL 4W/120 OHM
0950.000		292104087406		SHIFTSTECKER KPL 4W/220 OHM	SHIFT PLUG CPL 4W/220 OHM
2400.000		296420660300		TP 150 C FERNBEDIENUNG	TP 150 C REMOTE CONTROL
2410.000		720086745000		DECKEL BATTERIE	BATTERY LID
		219839410200		BEDIENUNGSANLEITUNG D/I	OPERATING INSTRUCTIONS D/I
		720100305000		SERVICE MANUAL D/GB	SERVICE MANUAL D/GB
		720100305400		SERVICE MANUAL D/GB 4.ERGAENZUNG	SERVICE MANUAL D/GB 4TH SUPPLEMENT
		720100305500		SERVICE MANUAL D/GB 5.ERGAENZUNG	SERVICE MANUAL D/GB 5TH SUPPLEMENT
		720100305600		SERVICE MANUAL D/GB 6.ERGAENZUNG	SERVICE MANUAL D/GB 6TH SUPPLEMENT
		297040190800	X	CHASSIS-FS-STEREO DIGI 100 CUC 1837 KEIN E-TEIL	CHASSIS TV STEREO DIGI 100 CUC 1837 NO SPARE PART
				X = SIEHE GESONDERTE E-LISTE	X = SEE SEPARATE PARTS LIST
				ALLE ANDEREN TEILE SIEHE E-LISTE ST 70-398 DOLBY MAT.-NR.: 921983017500 BESTELL-NR.: GCM3300 AUSGABE 1/2001 VERSION-NR.: VNM	FOR ALL OTHER PARTS SEE ST 70-398 DOLBY PART NO.: 921983017500 ORDER NO.: GCM3300 EDITION 1/2001 VERSION NO.: VNM

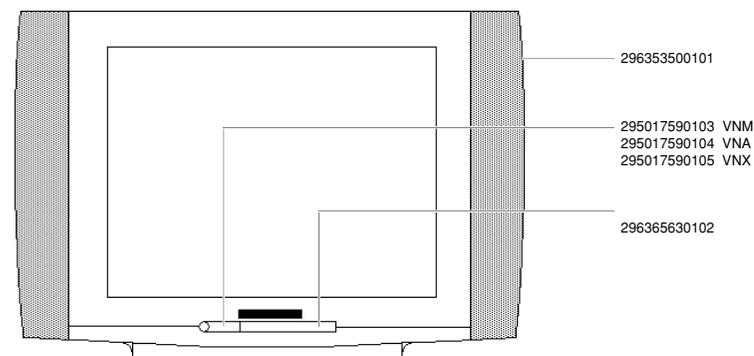

Es gelten die Vorschriften und Sicherheitshinweise gemäß dem Service Manual "Sicherheit", Mat.-Nummer 720108000000, sowie zusätzlich die eventuell abweichenden, landesspezifischen Vorschriften!



The regulations and safety instructions shall be valid as provided by the "Safety" Service Manual, part number 720108000000, as well as the respective national deviations.

ÄNDERUNGEN VORBEHALTEN / SUBJECT TO ALTERATION

### Ersatzteilliste Spare Parts List

6 / 2002

**M 70-879/8 DOLBY**

MATERIAL-NR. / PART NO.: 921987026900 BESTELL-NR. / ORDER NO.: GCM5100 TESSA BLACK  
VERSION NR./VERSION NO.: VNA

POS. NR. POS. NO.	ABB. FIG.	MATERIAL-NR. PART NUMBER	ANZ. QTY.	BEZEICHNUNG ①	DESCRIPTION ②
		921987026900		M 70-879/8 DOLBY TESSA BLACK KEIN E-TEIL	M 70-879/8 DOLBY TESSA BLACK NO SPARE PART
0210.000		295017610104		BEDIENEINSATZ MONTIERT KPL	CONTROL INSERT MOUNTED CPL
0225.000		295017623202		KLAPPE DRUCK KPL	FLAP PRINT CPL
0312.000		297006510104		ABDECKUNG DIGI-100	COVER DIGI-100
0320.000		291104276403		TYPENAUFKLEBER VNA	TYPE LABEL SELF ADHESIVE VNA
0700.000	△	092461317507		ENTMAGNETISIERUNGSSPULE	DEGAUSSING COIL
0950.000		292104087100		SHIFTSTECKER KPL 4W/120 OHM	SHIFT PLUG CPL 4W/120 OHM
0950.000		292104087406		SHIFTSTECKER KPL 4W/220 OHM	SHIFT PLUG CPL 4W/220 OHM
1100.000		830003047400		BILDROHR A 66 EAK554X44 PHILIPS	PICTURE TUBE A 66 EAK554X44 PHILIPS
2410.000		720086730000		DECKEL BATTERIE	BATTERY LID
219879410201		219879410301		BEDIENUNGSANLEITUNG D	OPERATING INSTRUCTIONS D
219879410301		219879410401		BEDIENUNGSANLEITUNG F/I	OPERATING INSTRUCTIONS F/I
219879410401		219879410501		BEDIENUNGSANLEITUNG GB/NL	OPERATING INSTRUCTIONS GB/NL
219879410501		219879410601		BEDIENUNGSANLEITUNG E/P	OPERATING INSTRUCTIONS E/P
219879410601		219879410701		BEDIENUNGSANLEITUNG DK/FIN	OPERATING INSTRUCTIONS DK/FIN
219879410701		720100305000		BEDIENUNGSANLEITUNG S/N	OPERATING INSTRUCTIONS S/N
720100305000		720100305000		SERVICE MANUAL D/GB	SERVICE MANUAL D/GB
720100305000		720100305000		SERVICE MANUAL D/GB 4. ERGAENZUNG	SERVICE MANUAL D/GB 4TH SUPPLEMENT
720100305000		720100305000		SERVICE MANUAL D/GB 5. ERGAENZUNG	SERVICE MANUAL D/GB 5TH SUPPLEMENT
720100305000		720100305000		SERVICE MANUAL D/GB 6. ERGAENZUNG	SERVICE MANUAL D/GB 6TH SUPPLEMENT
297040193400	X	CHASSIS-FS-STEREO DIGI 100		CHASSIS TV STEREO DIGI 100	CHASSIS TV STEREO DIGI 100
		CUC 1837		CUC 1837	CUC 1837
		KEIN E-TEIL		KEIN E-TEIL	NO SPARE PART
		X = SIEHE GESONDERTE E-LISTE		X = SIEHE GESONDERTE E-LISTE	X = SEE SEPARATE PARTS LIST
		ALLE ANDEREN TEILE SIEHE E-LISTE		ALLE ANDEREN TEILE SIEHE E-LISTE	FOR ALL OTHER PARTS SEE
		M 70-879/8 DOLBY		M 70-879/8 DOLBY	M 70-879/8 DOLBY
		MAT.-NR: 921987026900		MAT.-NR: 921987026900	PART NO: 921987026900
		BESTELL-NR: GCM5100		BESTELL-NR: GCM5100	ORDER NO: GCM5100
		AUSGABE 1/2001		AUSGABE 1/2001	EDITION 1/2001
		VERSION-NR.: VNM		VERSION-NR.: VNM	VERSION NO.: VNM

**M 70-879/8 DOLBY**

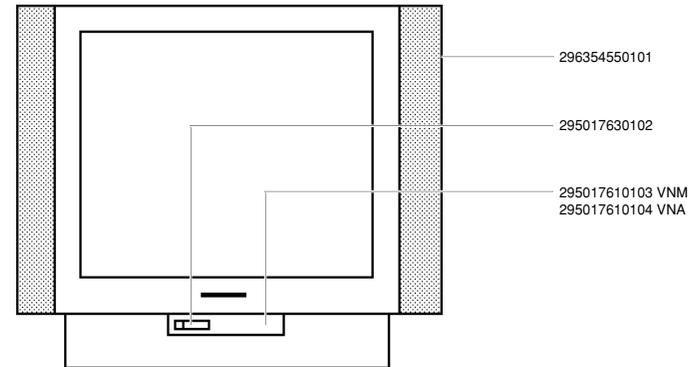

POS. NR. MATERIAL-NR. BEZEICHNUNG  
POS. NO. PART NUMBER DESCRIPTION

POS. NR. MATERIAL-NR. BEZEICHNUNG  
POS. NO. PART NUMBER DESCRIPTION

Es gelten die Vorschriften und Sicherheitshinweise gemäß dem Service Manual "Sicherheit", Mat.-Nummer 720108000000, sowie zusätzlich die eventuell abweichenden, landesspezifischen Vorschriften!



The regulations and safety instructions shall be valid as provided by the "Safety" Service Manual, part number 720108000000, as well as the respective national deviations.

ÄNDERUNGEN VORBEHALTEN / SUBJECT TO ALTERATION

ÄNDERUNGEN VORBEHALTEN / SUBJECT TO ALTERATION

### Ersatzteilliste Spare Parts List

#### 6 / 2002

#### ELEGANCE 70 M 70-3110 DOLBY

MATERIAL-NR. / PART NO.: 921916314000 BESTELL-NR. / ORDER NO.: GCN6400 PROCON SILBER/PROCON SILVER  
VERSION NR./VERSION NO.: VNA

POS. NR. POS. NO.	ABB. FIG.	MATERIAL-NR. PART NUMBER	ANZ. QTY.	BEZEICHNUNG (D)	DESCRIPTION (GB)
		921916314000		ELEGANCE 70 M 70-3110 DOLBY PROCON SILBER KEIN E-TEIL	ELEGANCE 70 M 70-3110 DOLBY PROCON SILVER NO SPARE PART
0206.000		296367050105	2	SCHALLWAND M.VLIES KPL TYPENAUFKLEBER VNA	BAFFLE W.FLEECE CPL TYPE LABEL SELF ADHESIVE VNA
0320.000		291104666401		HALTER LEITERPLATTE	HOLDER PCB
0450.000		297006544101		SHIFTSTECKER KPL 4W/120 OHM	SHIFT PLUG CPL 4W/120 OHM
0950.000		292104087100		SHIFTSTECKER KPL 4W/220 OHM	SHIFT PLUG CPL 4W/220 OHM
0950.000		292104087406		BEDIENEINSATZ MONTIERT KPL	CONTROL INSERT MOUNTED CPL
1301.000		295017610104		KLAPPE DRUCK KPL	FLAP PRINT CPL
1352.000		295017623102		TP 150 C FERNBEDIENUNG	TP 150 C REMOTE CONTROL
2400.000		296420660400		DECKEL BATTERIE	BATTERY LID
2410.000		720086745100			
		219169412900		BEDIENUNGSANLEITUNG D	OPERATION INSTRUCTIONS D
		219169413000		BEDIENUNGSANLEITUNG F/I	OPERATION INSTRUCTIONS F/I
		219169413100		BEDIENUNGSANLEITUNG GB/NL	OPERATION INSTRUCTIONS GB/NL
		720100305000		SERVICE MANUAL D/GB	SERVICE MANUAL D/GB
		720100305400		SERVICE MANUAL D/GB 4.ERGAENZUNG	SERVICE MANUAL D/GB 4TH SUPPLEMENT
		720100305500		SERVICE MANUAL D/GB 5.ERGAENZUNG	SERVICE MANUAL D/GB 5TH SUPPLEMENT
		720100305600		SERVICE MANUAL D/GB 6.ERGAENZUNG	SERVICE MANUAL D/GB 6TH SUPPLEMENT

ALLE ANDEREN TEILE SIEHE E-LISTE  
ELEGANCE 70 M 70-3110 DOLBY  
MAT.-NR: 921916314000  
BESTELL-NR: G.CN 6400  
AUSGABE 5/2001  
VERSION-NR.: VNM

FOR ALL OTHER PARTS SEE  
ELEGANCE 70 M 70-3110 DOLBY  
PART NO: 921916314000  
ORDER NO: G.CN 6400  
EDITION 5/2001  
VERSION NO.: VNM

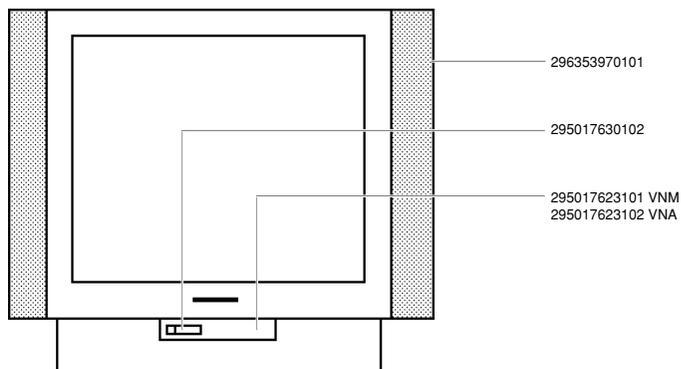

Es gelten die Vorschriften und Sicherheitshinweise gemäß dem Service Manual "Sicherheit", Mat.-Nummer 720108000000, sowie zusätzlich die eventuell abweichenden, landesspezifischen Vorschriften!



The regulations and safety instructions shall be valid as provided by the "Safety" Service Manual, part number 720108000000, as well as the respective national deviations.

ÄNDERUNGEN VORBEHALTEN / SUBJECT TO ALTERATION

### Ersatzteilliste Spare Parts List

#### 6 / 2002

#### ELEGANCE 70 M 70-3110 DOLBY

MATERIAL-NR. / PART NO.: 921916314000 BESTELL-NR. / ORDER NO.: GCN6400 PROCON SILBER/PROCON SILVER  
VERSION NR./VERSION NO.: VNX

POS. NR. POS. NO.	ABB. FIG.	MATERIAL-NR. PART NUMBER	ANZ. QTY.	BEZEICHNUNG (D)	DESCRIPTION (GB)
		921916314000		ELEGANCE 70 M 70-3110 DOLBY PROCON SILBER KEIN E-TEIL	ELEGANCE 70 M 70-3110 DOLBY PROCON SILVER NO SPARE PART
0206.000		296367050105	2	SCHALLWAND M.VLIES KPL ABDECKUNG DIGI-100	BAFFLE W.FLEECE CPL COVER DIGI-100
0206.000		297006510104		TYPENAUFKLEBER VNX	TYPE LABEL SELF ADHESIVE VNX
0320.000		291104666501		ENTMAGNETISIERUNGSSPULE	DEGAUSSING COIL
0700.000		092461317507		SHIFTSTECKER KPL 4W/120 OHM	SHIFT PLUG CPL 4W/120 OHM
0950.000		292104087100		SHIFTSTECKER KPL 4W/220 OHM	SHIFT PLUG CPL 4W/220 OHM
0950.000		292104087406		BILDROHR A 66 EAK554X44	PICTURE TUBE A 66 EAK554X44
1100.000		830003047400		BEDIENEINSATZ MONTIERT KPL	CONTROL INSERT MOUNTED CPL
1301.000		295017610104		KLAPPE DRUCK KPL	FLAP PRINT CPL
1352.000		295017623102		TP 150 C FERNBEDIENUNG	TP 150 C REMOTE CONTROL
2400.000		296420660400		DECKEL BATTERIE	BATTERY LID
2410.000		720086745100			
		219169412900		BEDIENUNGSANLEITUNG D	OPERATION INSTRUCTIONS D
		219169413000		BEDIENUNGSANLEITUNG F/I	OPERATION INSTRUCTIONS F/I
		219169413100		BEDIENUNGSANLEITUNG GB/NL	OPERATION INSTRUCTIONS GB/NL
		720100305000		SERVICE MANUAL D/GB	SERVICE MANUAL D/GB
		720100305400		SERVICE MANUAL D/GB 4.ERGAENZUNG	SERVICE MANUAL D/GB 4TH SUPPLEMENT
		720100305500		SERVICE MANUAL D/GB 5.ERGAENZUNG	SERVICE MANUAL D/GB 5TH SUPPLEMENT
		720100305600		SERVICE MANUAL D/GB 6.ERGAENZUNG	SERVICE MANUAL D/GB 6TH SUPPLEMENT

297040191300 X

CHASSIS-FS-STEREO DIGI 100  
CUC 1837  
KEIN E-TEIL

CHASSIS TV STEREO DIGI 100  
CUC1837  
NO SPARE PART

X = SIEHE GESONDERTE E-LISTE

X = SEE SEPARATE PARTS LIST

ALLE ANDEREN TEILE SIEHE E-LISTE  
ELEGANCE 70 M 70-3110 DOLBY  
MAT.-NR: 921916314000  
BESTELL-NR: G.CN 6400  
AUSGABE 5/2001  
VERSION-NR.: VNM

FOR ALL OTHER PARTS SEE  
ELEGANCE 70 M 70-3110 DOLBY  
PART NO: 921916314000  
ORDER NO: G.CN 6400  
EDITION 5/2001  
VERSION NO.: VNM

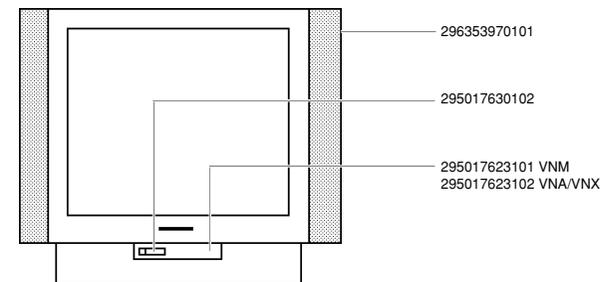

Es gelten die Vorschriften und Sicherheitshinweise gemäß dem Service Manual "Sicherheit", Mat.-Nummer 720108000000, sowie zusätzlich die eventuell abweichenden, landesspezifischen Vorschriften!



The regulations and safety instructions shall be valid as provided by the "Safety" Service Manual, part number 720108000000, as well as the respective national deviations.

ÄNDERUNGEN VORBEHALTEN / SUBJECT TO ALTERATION

MATERIAL-NR. / PART NO.: 921844012400 BESTELL-NR. / ORDER NO.: GC12324 NUSSBAUM/WALNUT  
VERSION NR./VERSION NO.: VNA

POS. NR. POS. NO.	ABB. FIG.	MATERIAL-NR. PART NUMBER	ANZ. QTY.	BEZEICHNUNG D	DESCRIPTION GB
		921844012400		BOSTON SE 7012 DOLBY NUSSBAUM KEIN E-TEIL	BOSTON SE 7012 DOLBY WALNUT NO SPARE PART
0050.000				PROGRAMM FLASH-EPROM DOWNLOAD: WWW.GRUNDIG.DE/ PRODUKTE/KONTAKT/HAENDLERSERVICE	PROGRAM FLASH EPROM DOWNLOAD: WWW.GRUNDIG.DE/ PRODUCTS/CONTACT/RESELLER SUPPORT
0200.000		296258010202		GEH-VORDETEIL OFB	CABINET FRONT PART SURF. TREATED
0229.000		296321140102		EMBLEM GRUNDIG	EMBLEM GRUNDIG
0300.000		296366308004		GEH-RUECKTEIL	CABINET REAR PART
0320.000		291102856402		TYPENAUFKLEBER VNA	TYPE LABEL SELF ADHESIVE VNA
WW.		291104986401		TYPENAUFKLEBER VNA	TYPE LABEL SELF ADHESIVE VNA
0350.000		296383960102	2	ZWISCHENSTUECK RUECKWANDBEFESTIG.	INTERMEDIATE PIECE REAR PANEL FIXING
0700.000	Δ	092461317507		ENTMAGNETISIERUNGSSPULE	DEGAUSSING COIL
0950.000		292104087406		SHIFTSTECKER KPL 4W/220 OHM	SHIFT PLUG CPL 4W/220 OHM
0950.000		292104087100		SHIFTSTECKER KPL 4W/120 OHM	SHIFT PLUG CPL 4W/120 OHM
1860.000	Δ	297033910600		NETZSCHALTER O.WISCHER	POWER SWITCH W/O WISCHER
2410.000		720086734000		DECKEL BATTERIE	BATTERY LID
		218449410100		BEDIENUNGSANLEITUNG D	OPERATION INSTRUCTIONS D
		720100305000		SERVICE MANUAL D/GB	SERVICE MANUAL D/GB
		720100305400		SERVICE MANUAL D/GB 4.ERGAENZUNG	SERVICE MANUAL D/GB 4TH SUPPLEMENT
		720100305500		SERVICE MANUAL D/GB 5.ERGAENZUNG	SERVICE MANUAL D/GB 5TH SUPPLEMENT
		720100305600		SERVICE MANUAL D/GB 6.ERGAENZUNG	SERVICE MANUAL D/GB 6TH SUPPLEMENT
		297040193700	X	CHASSIS-FS-STEREO DIGI 100 CUC 1837 KEIN E-TEIL	CHASSIS TV STEREO DIGI 100 CUC 1837 NO SPARE PART
				X = SIEHE GESONDERTE E-LISTE WW. = WAHLWEISE	X = SEE SEPARATE PARTS LIST WW. = OPTIONAL
				ALLE WEITEREN TEILE SIEHE E-LISTE BOSTON SE 7012 DOLBY MAT.-NR.: 921844012400 BESTELL-NR.: GC12324 AUSGABE 1/2001 VERSION NR.: VNM	FOR ALL OTHER PARTS SEE BOSTON SE 7012 DOLBY PART NO.: 921844012400 ORDER NO.: GC12324 EDITION 1/2001 VERSION NO.: VNM

#### BOSTON SE 7012 DOLBY

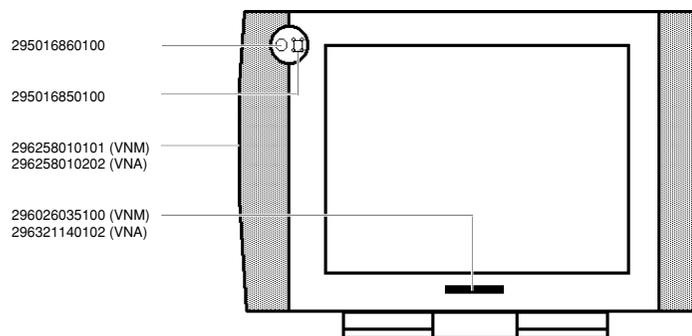

POS. NR. MATERIAL-NR. BEZEICHNUNG  
POS. NO. PART NUMBER DESCRIPTION

POS. NR. MATERIAL-NR. BEZEICHNUNG  
POS. NO. PART NUMBER DESCRIPTION

Es gelten die Vorschriften und Sicherheitshinweise gemäß dem Service Manual "Sicherheit", Mat.-Nummer 720108000000, sowie zusätzlich die eventuell abweichenden, landesspezifischen Vorschriften!



The regulations and safety instructions shall be valid as provided by the "Safety" Service Manual, part number 720108000000, as well as the respective national deviations.

### 6 / 2002

### BOSTON SE 7012 DOLBY

MATERIAL-NR. / PART NO.: 921844017500    BESTELL-NR. / ORDER NO.: GCI2375    SCHWARZ/BLACK  
VERSION NR./VERSION NO.: **VNA**

POS. NR. POS. NO.	ABB. FIG.	MATERIAL-NR. PART NUMBER	ANZ. QTY.	BEZEICHNUNG (D)	DESCRIPTION (GB)
		921844017500		BOSTON SE 7012 DOLBY SCHWARZ KEIN E-TEIL	BOSTON SE 7012 DOLBY BLACK NO SPARE PART
0050.000				PROGRAMM FLASH-EPROM DOWNLOAD: WWW.GRUNDIG.DE/ PRODUKTE/KONTAKT/HAENDLERSERVICE	PROGRAM FLASH EPROM DOWNLOAD: WWW.GRUNDIG.DE/ PRODUCTS/CONTACT/RESELLER SUPPORT
0300.000 0320.000 WW.		296366308004 291104986401		GEH-RUECKTEIL TYPENAUFKLEBER VNA TYPENAUFKLEBER VNA	CABINET REAR PART TYPE LABEL SELF ADHESIVE VNA TYPE LABEL SELF ADHESIVE VNA
0350.000 0700.000 0950.000 0950.000 1860.000 2410.000	△	296383960102 092461317507 292104087100 292104087406 297033910600 720086734000	2	ZWISCHENSTUECK RUECKWANDBEFESTIG. ENTMAGNETISIERUNGSSPULE SHIFTSTECKER KPL 4W/120 OHM SHIFTSTECKER KPL 4W/220 OHM NETZSCHALTER O.WISCHER DECKEL BATTERIE	INTERMEDIATE PIECE REAR PANEL FIXING DEGAUSSING COIL SHIFT PLUG CPL 4W/120 OHM SHIFT PLUG CPL 4W/220 OHM POWER SWITCH W/O WIPER BATTERY LID
		218449410100 720100305000 720100305400 720100305500 720100305600		BEDIENUNGSANLEITUNG D SERVICE MANUAL D/GB SERVICE MANUAL D/GB 4.ERGAENZUNG SERVICE MANUAL D/GB 5.ERGAENZUNG SERVICE MANUAL D/GB 6.ERGAENZUNG	OPERATING INSTRUCTIONS D SERVICE MANUAL D/GB SERVICE MANUAL D/GB 4TH SUPPLEMENT SERVICE MANUAL D/GB 5TH SUPPLEMENT SERVICE MANUAL D/GB 6TH SUPPLEMENT
		297040193700	X	CHASSIS-FS-STEREO DIGI 100 CUC 1837 KEIN E-TEIL	CHASSIS TV STEREO DIGI 100 CUC 1837 NO SPARE PART
				X = SIEHE GESONDERTE E-LISTE WW. = WAHLWEISE	X = SEE SEPARATE PARTS LIST WW. = OPTIONAL
				ALLE ANDEREN TEILE SIEHE E-LISTE BOSTON SE 7012 DOLBY MAT.-NR: 921844017500 BESTELL-NR: G.CI 2375 AUSGABE 1/2001 VERSION-NR.: <b>VNM</b>	FOR ALL OTHER PARTS SEE BOSTON SE 7012 DOLBY PART NO: 921844017500 ORDER NO: G.CI 2375 EDITION 1/2001 VERSION NO.: <b>VNM</b>

### 6 / 2002

### M 72-109 MV/DOLBY

MATERIAL-NR. / PART NO.: 921988027500    BESTELL-NR. / ORDER NO.: GCM5300    SCHWARZ/BLACK  
VERSION NR./VERSION NO.: **VNA**

POS. NR. POS. NO.	ABB. FIG.	MATERIAL-NR. PART NUMBER	ANZ. QTY.	BEZEICHNUNG (D)	DESCRIPTION (GB)
		921988027500		M 72-109 MV/DOLBY SCHWARZ KEIN E-TEIL	M 72-109 MV/DOLBY BLACK NO SPARE PART
0200.000 0229.000 0314.000 0320.000 0950.000 0950.000 2300.000		296354620102 296321140102 297006513102 291104316404 292104087606 292104087306 293051223100		GEH-VORDEITEIL DRUCK KPL EMBLEM GRUNDIG ABDECKUNG M.KOAX-KABEL TYPENAUFKLEBER VNA SHIFTSTECKER KPL 5W/180 OHM SHIFTSTECKER KPL 4W/330 OHM BILDROHRPLATTE	CABINET FRONT PART PRINT CPL EMBLEM GRUNDIG COVER W.COAX CABLE TYPE LABEL SELF ADHESIVE VNA SHIFT PLUG CPL 5W/180 OHM SHIFT PLUG CPL 4W/330 OHM PICTURE TUBE BOARD
		219889410200 219889410400 219889410500 219889410600 219889410700 720100305000 720100305400 720100305500 720100305600		BEDIENUNGSANLEITUNG D BEDIENUNGSANLEITUNG GB/NL BEDIENUNGSANLEITUNG E/P BEDIENUNGSANLEITUNG DK/FIN BEDIENUNGSANLEITUNG S/N SERVICE MANUAL D/GB SERVICE MANUAL D/GB 4.ERGAENZUNG SERVICE MANUAL D/GB 5.ERGAENZUNG SERVICE MANUAL D/GB 6.ERGAENZUNG	OPERATION INSTRUCTIONS D OPERATION INSTRUCTIONS GB/NL OPERATION INSTRUCTIONS E/P OPERATION INSTRUCTIONS DK/FIN OPERATION INSTRUCTIONS S/N SERVICE MANUAL D/GB SERVICE MANUAL D/GB 4TH SUPPLEMENT SERVICE MANUAL D/GB 5TH SUPPLEMENT SERVICE MANUAL D/GB 6TH SUPPLEMENT
		297040115300	X	CHASSIS-FS-STEREO DIGI 100 CUC 1838 KEIN E-TEIL	CHASSIS TV STEREO DIGI 100 CUC 1838 NO SPARE PART
				X = SIEHE GESONDERTE E-LISTE	X = SEE SEPARATE PARTS LIST
				ALLE ANDEREN TEILE SIEHE E-LISTE M 72-109 MV/DOLBY MAT.-NR: 921988027500 BESTELL-NR: G.CM 5300 AUSGABE 3/2001 VERSION-NR.: <b>VNM</b>	FOR ALL OTHER PARTS SEE M 72-109 MV/DOLBY PART NO: 921988027500 ORDER NO: G.CM 5300 EDITION 3/2001 VERSION NO.: <b>VNM</b>

Es gelten die Vorschriften und Sicherheitshinweise gemäß dem Service Manual "Sicherheit", Mat.-Nummer 720108000000, sowie zusätzlich die eventuell abweichenden, landesspezifischen Vorschriften!



The regulations and safety instructions shall be valid as provided by the "Safety" Service Manual, part number 720108000000, as well as the respective national deviations.

ÄNDERUNGEN VORBEHALTEN / SUBJECT TO ALTERATION

ÄNDERUNGEN VORBEHALTEN / SUBJECT TO ALTERATION

POS. NR. MATERIAL-NR. BEZEICHNUNG  
 POS. NO. PART NUMBER DESCRIPTION

POS. NR. MATERIAL-NR. BEZEICHNUNG  
 POS. NO. PART NUMBER DESCRIPTION

**M 72-109 MV/DOLBY**

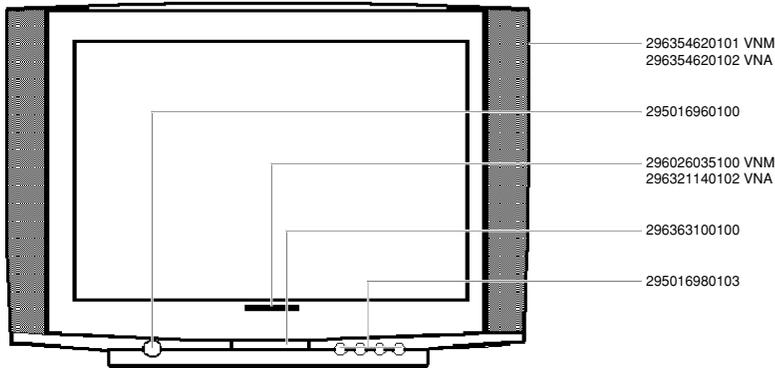

64

**Ersatzteilliste  
 Spare Parts List**

**TV**

**6 / 2002**

**M 72-109 MV/DOLBY**

MATERIAL-NR. / PART NO.: 921988027500 BESTELL-NR. / ORDER NO.: GCM5300 SCHWARZ/BLACK  
 VERSION NR./VERSION NO.: VNX

POS. NR. POS. NO.	ABB. FIG.	MATERIAL-NR. PART NUMBER	ANZ. QTY.	BEZEICHNUNG (D)	DESCRIPTION (GB)
		921988027500		M 72-109 MV/DOLBY SCHWARZ KEIN E-TEIL	M 72-109 MV/DOLBY BLACK NO SPARE PART
0200.000		296354620102		GEH.-VORDEITEIL DRUCK KPL EMBLEM GRUNDIG	CABINET FRONT PART PRINT CPL EMBLEM GRUNDIG
0229.000		296321140102		GEH.-RUECKTEIL	CABINET REAR PART
0300.000		296319818715		ABDECKUNG M.KOAX-KABEL	COVER W.COAX CABLE
0314.000		297006513102		TYPENAUFKLEBER VNX	TYPE LABEL SELF ADHESIVE VNX
0320.000		291104316504		SHIFTSTECKER KPL 5W/180 OHM	SHIFT PLUG CPL 5 W/180 OHM
0950.000		292104087606		SHIFTSTECKER KPL 4W/330 OHM	SHIFT PLUG CPL 4 W/330 OHM
0950.000		292104087306		BILDROHR A 68 ESF002X43 PHILIPS	PICTURE TUBE A 68 ESF002X43 PHILIPS
1100.000		830006824300		BILDROHRPLATTE	PICTURE TUBE BOARD
2300.000		293051223100	X		
		219889410200		BEDIENUNGSANLEITUNG D	OPERATION INSTRUCTIONS D
		219889410400		BEDIENUNGSANLEITUNG GB/NL	OPERATION INSTRUCTIONS GB/NL
		219889410500		BEDIENUNGSANLEITUNG E/P	OPERATION INSTRUCTIONS E/P
		219889410600		BEDIENUNGSANLEITUNG DK/FIN	OPERATION INSTRUCTIONS DK/FIN
		219889410700		BEDIENUNGSANLEITUNG S/N	OPERATION INSTRUCTIONS S/N
		720100305000		SERVICE MANUAL D/GB	SERVICE MANUAL D/GB
		720100305400		SERVICE MANUAL D/GB 4.ERGAENZUNG	SERVICE MANUAL D/GB 4TH SUPPLEMENT
		720100305500		SERVICE MANUAL D/GB 5.ERGAENZUNG	SERVICE MANUAL D/GB 5TH SUPPLEMENT
		720100305600		SERVICE MANUAL D/GB 6.ERGAENZUNG	SERVICE MANUAL D/GB 6TH SUPPLEMENT
		297040192200	X	CHASSIS-FS-STEREO DIGI 100 CUC 1838 KEIN E-TEIL	CHASSIS TV STEREO DIGI 100 CUC 1838 NO SPARE PART
				X = SIEHE GESONDERTE E-LISTE	X = SEE SEPARATE PARTS LIST
				ALLE ANDEREN TEILE SIEHE E-LISTE M 72-109 MV/DOLBY MAT.-NR: 921988027500 BESTELL-NR: G.CM 5300 AUSGABE 3/2001 VERSION-NR.: VNM	FOR ALL OTHER PARTS SEE M 72-109 MV/DOLBY PART NO: 921988027500 ORDER NO: G.CM 5300 EDITION 3/2001 VERSION NO.: VNM

Es gelten die Vorschriften und Sicherheitshinweise gemäß dem Service Manual "Sicherheit", Mat.-Nummer 720108000000, sowie zusätzlich die eventuell abweichenden, landesspezifischen Vorschriften!



The regulations and safety instructions shall be valid as provided by the "Safety" Service Manual, part number 720108000000, as well as the respective national deviations.

ÄNDERUNGEN VORBEHALTEN / SUBJECT TO ALTERATION

ÄNDERUNGEN VORBEHALTEN / SUBJECT TO ALTERATION

POS. NR. MATERIAL-NR. BEZEICHNUNG  
 POS. NO. PART NUMBER DESCRIPTION

POS. NR. MATERIAL-NR. BEZEICHNUNG  
 POS. NO. PART NUMBER DESCRIPTION

M 72-109 MV/DOLBY

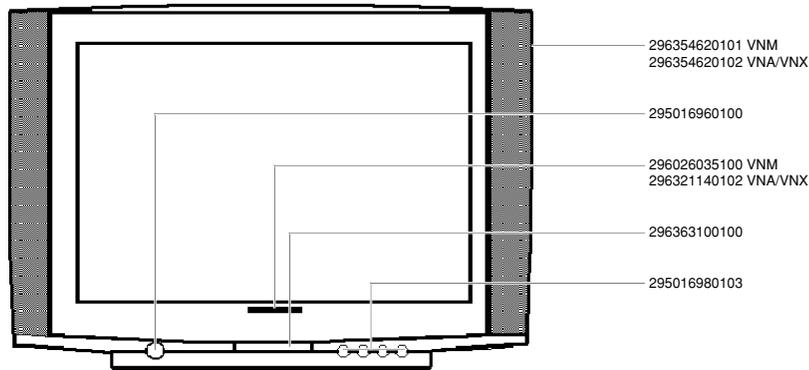

65

Ersatzteilliste  
 Spare Parts List

6 / 2002

MF 72-258 DOLBY

MATERIAL-NR. / PART NO.: 922211014000 BESTELL-NR. / ORDER NO.: GCM8200 PROCON SILBER/PROCON SILVER  
 VERSION NR./VERSION NO.: VNA

POS. NR. POS. NO.	ABB. FIG.	MATERIAL-NR. PART NUMBER	ANZ. QTY.	BEZEICHNUNG Ⓧ	DESCRIPTION Ⓧ
		922211014000		MF 72-258 DOLBY PROCON SILBER KEIN E-TEIL	MF 72-258 DOLBY PROCON SILVER NO SPARE PART
0050.000				PROGRAMM FLASH-EPROM <b>DEUTSCHLAND</b> DOWNLOAD: HTTP://PARTNERWEB. GRUNDIG.DE/KUNDENDIENST PROGRAMM FLASH-EPROM <b>INTERNATIONAL</b> DOWNLOAD: WWW.GRUNDIG.DE/ PRODUKTE/KONTAKT/HAENDLERSERVICE	PROGRAM FLASH EPROM <b>GERMANY</b> DOWNLOAD: HTTP://PARTNERWEB. GRUNDIG.DE/KUNDENDIENST PROGRAM FLASH EPROM <b>INTERNATIONAL</b> DOWNLOAD: WWW.GRUNDIG.DE/ PRODUCTS/CONTACT/RESELLER SUPPORT
0217.000		296088640102	5	SOCKELEINLAGE	BASE INSERT
0225.000		295017623102		KLAPPE DRUCK KPL BEDIEN TEIL	FLAP PRINT CPL CONTROL UNIT
0320.000		291105296401		TYPENAUFKLEBER VNA	TYPE LABEL SELF ADHESIVE VNA
0320.000		291104436403		TYPENAUFKLEBER VNA	TYPE LABEL SELF ADHESIVE VNA
0350.000		296383650101		ZWISCHENSTUECK RUECKWANDBEFEST.	INTERMEDIATE PIECE REAR PANEL FIXING
0450.000		297006544101		HALTER LEITERPLATTE	HOLDER PCB
0450.000		297006542101		HALTER FOKUSBLOCK	HOLDER FOCUS UNIT
0950.000		292104087306		SHIFTSTECKER KPL 4W/330 OHM	SHIFT PLUG CPL 4W/330 OHM
0950.000		292104087606		SHIFTSTECKER KPL 5W/180 OHM	SHIFT PLUG CPL 5W/180 OHM
1100.000	⚠	830006889400		BILDROHR A 68 QCP893X539 SAMSUNG	PICT. TUBE A 68 QCP893X539 SAMSUNG
2300.000		293051224500	X	BILDROHRPLATTE	PICT. TUBE BOARD
		222119410200		BEDIENUNGSANLEITUNG D	OPERATION INSTRUCTIONS D
		222119410300		BEDIENUNGSANLEITUNG F/I	OPERATION INSTRUCTIONS F/I
		222119410400		BEDIENUNGSANLEITUNG GB/NL	OPERATION INSTRUCTIONS GB/NL
		720100305000		SERVICE MANUAL D/GB	SERVICE MANUAL D/GB
		720100305400		SERVICE MANUAL D/GB 4.ERGAENZUNG	SERVICE MANUAL D/GB 4TH SUPPLEMENT
		720100305500		SERVICE MANUAL D/GB 5.ERGAENZUNG	SERVICE MANUAL D/GB 5TH SUPPLEMENT
		720100305600		SERVICE MANUAL D/GB 6.ERGAENZUNG	SERVICE MANUAL D/GB 6TH SUPPLEMENT
		297040191000	X	CHASSIS-FS-STEREO DIGI 100 CUC 1838 KEIN E-TEIL <b>FUER BR A68QCP893X539</b>	CHASSIS TV STEREO DIGI 100 CUC 1838 NO SPARE PART <b>FOR PT A68QCP893X539</b>
		297040193500	X	CHASSIS-FS-STEREO DIGI 100 CUC 1838 KEIN E-TEIL <b>FUER BR A68ERF231X044</b>	CHASSIS TV STEREO DIGI 100 CUC 1838 NO SPARE PART <b>FOR PT A68ERF231X044</b>
				X = SIEHE GESONDERTE E-LISTE WW.=WAHLWEISE	X = SEE SEPARATE PARTS LIST WW.=OPTIONAL
				ALLE ANDEREN TEILE SIEHE E-LISTE MF 72-258 DOLBY MAT.-NR: 922211014000 BESTELL-NR: G.CM 8200 AUSGABE 5/2201 VERSION-NR.: VNM	FOR ALL OTHER PARTS SEE MF 72-258 DOLBY PART NO: 922211014000 ORDER NO: G.CM 8200 EDITION 5/2001 VERSION NO.: VNM

Es gelten die Vorschriften und Sicherheitshinweise gemäß dem Service Manual "Sicherheit", Mat.-Nummer 720108000000, sowie zusätzlich die eventuell abweichenden, landesspezifischen Vorschriften!



The regulations and safety instructions shall be valid as provided by the "Safety" Service Manual, part number 720108000000, as well as the respective national deviations.

ÄNDERUNGEN VORBEHALTEN / SUBJECT TO ALTERATION

Es gelten die Vorschriften und Sicherheitshinweise gemäß dem Service Manual "Sicherheit", Mat.-Nummer 720108000000, sowie zusätzlich die eventuell abweichenden, landesspezifischen Vorschriften!



The regulations and safety instructions shall be valid as provided by the "Safety" Service Manual, part number 720108000000, as well as the respective national deviations.

ÄNDERUNGEN VORBEHALTEN / SUBJECT TO ALTERATION

### Ersatzteilliste Spare Parts List

6 / 2002

### XENTIA 72 M 72-420 DOLBY

MATERIAL-NR. / PART NO.: 921949014000 BESTELL-NR. / ORDER NO.: GCL6900 PROCON SILBER/PROCON SILVER  
VERSION NR./VERSION NO.: VNA

POS. NR. POS. NO.	ABB. FIG.	MATERIAL-NR. PART NUMBER	ANZ. QTY.	BEZEICHNUNG (D)	DESCRIPTION (GB)
		921949014000		XENTIA 72 M 72-420 DOLBY PROCON SILBER KEIN E-TEIL	XENTIA 72 M 72-420 DOLBY PROCON SILVER NO SPARE PART
0050.000				PROGRAMM FLASH-EPROM DOWNLOAD: WWW.GRUNDIG.DE/ PRODUKTE/KONTAKT/HAENDLERSERVICE	PROGRAM FLASH EPROM DOWNLOAD: WWW.GRUNDIG.DE/ PRODUCTS/CONTACT/RESELLER SUPPORT
0201.000 0312.000 0320.000 WW. 0950.000 0950.000 1100.000 1306.000		191260469701 297006510104 291102306403 291102906402 292104087306 292104087606 830006824300 295017380109	2	LAUTSPRECHER KOMBI ABDECKUNG DIGI-100 TYPENAUFKLEBER VNA TYPENAUFKLEBER VNA SHIFTSTECKER KPL 4W/330 OHM SHIFTSTECKER KPL 5W/180 OHM BILDROHR A 68 ESF002X43 PHILIPS AUFNAHME DRUCK KPL	LOUDSPEAKER COMBI COVER DIGI-100 TYPE LABEL SELF ADHESIVE VNA TYPE LABEL SELF ADHESIVE VNA SHIFT PLUG CPL 4W/330 OHM SHIFT PLUG CPL 5W/180 OHM PICTURE TUBE A 68 ESF002X43 PHILIPS HOLDER PRINT CPL
		219499410300 219499410400 219499410500 720100305000 720100305400 720100305500 720100305600		BEDIENUNGSANLEITUNG D BEDIENUNGSANLEITUNG F/I BEDIENUNGSANLEITUNG GB/NL SERVICE MANUAL D/GB SERVICE MANUAL D/GB 4. ERGAENZUNG SERVICE MANUAL D/GB 5. ERGAENZUNG SERVICE MANUAL D/GB 6. ERGAENZUNG	OPERATION INSTRUCTIONS D OPERATION INSTRUCTIONS F/I OPERATION INSTRUCTIONS GB/NL SERVICE MANUAL D/GB SERVICE MANUAL D/GB 4TH SUPPLEMENT SERVICE MANUAL D/GB 5TH SUPPLEMENT SERVICE MANUAL D/GB 6TH SUPPLEMENT
		297040193100	X	CHASSIS-FS-STEREO DIGI 100 CUC 1838 KEIN E-TEIL  X = SIEHE GESONDERTE E-LISTE WW. = WAHLWEISE  ALLE ANDEREN TEILE SIEHE E-LISTE XENTIA 72 M 72-420 DOLBY MAT.-NR: 921949014000 BESTELL-NR: G. CL 6900 AUSGABE 9/2001 VERSION-NR.: VNM	CHASSIS TV STEREO DIGI 100 CUC 1838 NO SPARE PART  X = SEE SEPARATE PARTS LIST WW. = OPTIONAL  FOR ALL OTHER PARTS SEE XENTIA 72 M 72-420 DOLBY PART NO: 921949014000 ORDER NO: G. CL 6900 EDITION 9/2001 VERSION NO.: VNM

ÄNDERUNGEN VORBEHALTEN / SUBJECT TO ALTERATION

POS. NR. MATERIAL-NR. BEZEICHNUNG  
POS. NO. PART NUMBER DESCRIPTION

POS. NR. MATERIAL-NR. BEZEICHNUNG  
POS. NO. PART NUMBER DESCRIPTION

### XENTIA 72 M 72-420 DOLBY

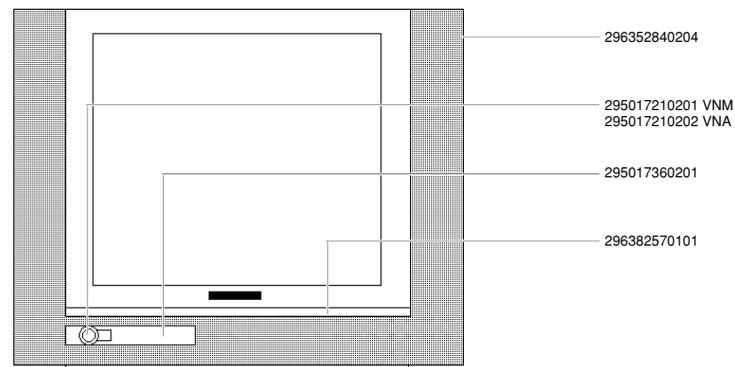

Es gelten die Vorschriften und Sicherheitshinweise gemäß dem Service Manual "Sicherheit", Mat.-Nummer 720108000000, sowie zusätzlich die eventuell abweichenden, landesspezifischen Vorschriften!



The regulations and safety instructions shall be valid as provided by the "Safety" Service Manual, part number 720108000000, as well as the respective national deviations.

ÄNDERUNGEN VORBEHALTEN / SUBJECT TO ALTERATION

MATERIAL-NR. / PART NO.: 921949017700 BESTELL-NR. / ORDER NO.: GCL6977 ELON METALLIC  
VERSION NR./VERSION NO.: VNA

POS. NR. POS. NO.	ABB. FIG.	MATERIAL-NR. PART NUMBER	ANZ. QTY.	BEZEICHNUNG (D)	DESCRIPTION (GB)
		921949017700		XENTIA 72 M 72-420 DOLBY ELON METALLIC KEIN E-TEIL	XENTIA 72 M 72-420 DOLBY ELON METALLIC NO SPARE PART
0050.000				PROGRAMM FLASH-EPROM DOWNLOAD: WWW.GRUNDIG.DE/ PRODUKTE/KONTAKT/HAENDLERSERVICE	PROGRAM FLASH EPROM DOWNLOAD: WWW.GRUNDIG.DE/ PRODUCTS/CONTACT/RESELLER SUPPORT
0201.000		191260469701	2	LAUTSPRECHER KOMBI	LOUDSPEAKER COMBI
0300.000		296363880203		GEH-RUECKTEIL OFB	CABINET REAR PART SURFACE TREATED
0312.000		297006510104		ABDECKUNG DIGI-100	COVER DIGI-100
0320.000		291102906402		TYPENAUFKLEBER VNA	TYPE LABEL SELF ADHESIVE VNA
WW.		291102306403		TYPENAUFKLEBER VNA	TYPE LABEL SELF ADHESIVE VNA
0950.000		292104087306		SHIFTSTECKER KPL 4W/330 OHM	SHIFT PLUG CPL 4W/330 OHM
0950.000		292104087606		SHIFTSTECKER KPL 5W/180 OHM	SHIFT PLUG CPL 5W/180 OHM
1100.000		830006824300		BILDROHR A 68 ESF002X43 PHILIPS	PICTURE TUBE A 68 ESF002X43 PHILIPS
1360.000	△	297033910600		NETZSCHALTER O.WISCHER	POWER SWITCH W/O WIPER
1370.000		295017210202		TASTENKNOPF NETZ KPL	KEY POWER CPL
1395.000		295017380109		AUFNAHME DRUCK KPL	HOLDER PRINT CPL
		219499410300		BEDIENUNGSANLEITUNG D	OPERATION INSTRUCTIONS D
		219499410400		BEDIENUNGSANLEITUNG F/I	OPERATION INSTRUCTIONS F/I
		219499410500		BEDIENUNGSANLEITUNG GB/NL	OPERATION INSTRUCTIONS GB/NL
		720100305000		SERVICE MANUAL D/GB	SERVICE MANUAL D/GB
		720100305400		SERVICE MANUAL D/GB 4.ERGAENZUNG	SERVICE MANUAL D/GB 4TH SUPPLEMENT
		720100305500		SERVICE MANUAL D/GB 5.ERGAENZUNG	SERVICE MANUAL D/GB 5TH SUPPLEMENT
		720100305600		SERVICE MANUAL D/GB 6.ERGAENZUNG	SERVICE MANUAL D/GB 6TH SUPPLEMENT
		297040193100	X	CHASSIS-FS-STEREO DIGI 100 CUC 1838 KEIN E-TEIL	CHASSIS TV STEREO DIGI 100 CUC 1838 NO SPARE PART
				X = SIEHE GESONDERTE E-LISTE WW. = WAHLWEISE	X = SEE SEPARATE PARTS LIST WW. = OPTIONAL
				ALLE ANDEREN TEILE SIEHE E-LISTE XENTIA 72 M 72-420 DOLBY MAT.-NR: 921949017700 BESTELL-NR: G.CL 6977 AUSGABE 1/2001 VERSION-NR.: VNM	FOR ALL OTHER PARTS SEE XENTIA 72 M 72-420 DOLBY PART NO: 921949017700 ORDER NO: G.CL 6977 EDITION 1/2001 VERSION NO.: VNM

ÄNDERUNGEN VORBEHALTEN / SUBJECT TO ALTERATION

POS. NR. MATERIAL-NR. BEZEICHNUNG  
POS. NO. PART NUMBER DESCRIPTION

POS. NR. MATERIAL-NR. BEZEICHNUNG  
POS. NO. PART NUMBER DESCRIPTION

### XENTIA 72 M 72-420 DOLBY

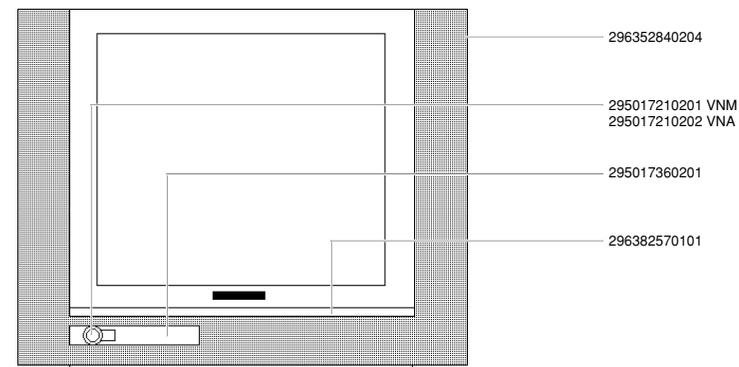

Es gelten die Vorschriften und Sicherheitshinweise gemäß dem Service Manual "Sicherheit", Mat.-Nummer 720108000000, sowie zusätzlich die eventuell abweichenden, landesspezifischen Vorschriften!



The regulations and safety instructions shall be valid as provided by the "Safety" Service Manual, part number 720108000000, as well as the respective national deviations.

ÄNDERUNGEN VORBEHALTEN / SUBJECT TO ALTERATION

### Ersatzteilliste Spare Parts List

6 / 2002

### XENTIA 72 M 72-420/8 DOLBY

MATERIAL-NR. / PART NO.: 921949024000 BESTELL-NR. / ORDER NO.: GCL7000 PROCON SILBER / PROCON SILVER  
VERSION NR./VERSION NO.: VNA

POS. NR. POS. NO.	ABB. FIG.	MATERIAL-NR. PART NUMBER	ANZ. QTY.	BEZEICHNUNG (D)	DESCRIPTION (GB)
		921949024000		XENTIA 72 M 72-420/8 DOLBY PROCON SILBER KEIN E-TEIL	XENTIA 72 M 72-420/8 DOLBY PROCON SILVER NO SPARE PART
0050.000				PROGRAMM FLASH-EPROM DOWNLOAD: WWW.GRUNDIG.DE/ PRODUKTE/KONTAKT/HAENDLERSERVICE	PROGRAM FLASH EPROM DOWNLOAD: WWW.GRUNDIG.DE/ PRODUCTS/CONTACT/RESELLER SUPPORT
0201.000		191260469701	2	LAUTSPRECHER KOMBI	LOUDSPEAKER COMBI
0206.000		296364430100		ABDECKUNG LAUTSPRECHER	COVER LOUDSPEAKER
0212.000		297006510104		ABDECKUNG DIGI-100	COVER DIGI-100
0217.000		296088640102	5	SOCKELEINLAGE	BASE INSERT
0222.000		296382570101		ZIERLEISTE KPL	ORNAMENTAL STRIP CPL
0320.000		291102316405		TYPENAUFKLEBER VNA	TYPE LABEL SELF ADHESIVE VNA
WW.		291102886404		TYPENAUFKLEBER VNA	TYPE LABEL SELF ADHESIVE VNA
0950.000		292104087306		SHIFTSTECKER KPL 4W/330 OHM	SHIFT PLUG CPL 4W/330 OHM
0950.000		292104087606		SHIFTSTECKER KPL 5W/180 OHM	SHIFT PLUG CPL 5W/180 OHM
1100.000		830006824300		BILDROHR A 68 ESF002X43 PHILIPS	PICTURE TUBE A 68 ESF002X43 PHILIPS
1306.000		295017380109		AUFNAHME DRUCK KPL	HOLDER PRINT CPL
		219499410600		BEDIENUNGSANLEITUNG D	OPERATION INSTRUCTIONS D
		219499410700		BEDIENUNGSANLEITUNG F/I	OPERATION INSTRUCTIONS F/I
		219499410800		BEDIENUNGSANLEITUNG GB/NL	OPERATION INSTRUCTIONS GB/NL
		219499410900		BEDIENUNGSANLEITUNG E/P	OPERATION INSTRUCTIONS E/P
		219499411000		BEDIENUNGSANLEITUNG DK/FIN	OPERATION INSTRUCTIONS DK/FIN
		219499411100		BEDIENUNGSANLEITUNG S/N	OPERATION INSTRUCTIONS S/N
		720100305000		SERVICE MANUAL D/GB	SERVICE MANUAL D/GB
		720100305400		SERVICE MANUAL D/GB 4.ERGAENZUNG	SERVICE MANUAL D/GB 4TH SUPPLEMENT
		720100305500		SERVICE MANUAL D/GB 5.ERGAENZUNG	SERVICE MANUAL D/GB 5TH SUPPLEMENT
		720100305600		SERVICE MANUAL D/GB 6.ERGAENZUNG	SERVICE MANUAL D/GB 6TH SUPPLEMENT
		297040193200	X	CHASSIS-FS-STEREO DIGI 100 CUC 1838 KEIN E-TEIL	CHASSIS TV STEREO DIGI 100 CUC 1838 NO SPARE PART
				X = SIEHE GESONDERTE E-LISTE WW. = WAHLWEISE	X = SEE SEPARATE PARTS LIST WW. = OPTIONAL
				ALLE ANDEREN TEILE SIEHE E-LISTE XENTIA 72 M 72-420/8 DOLBY MAT.-NR: 921949024000 BESTELL-NR: G.CL 7000 AUSGABE 9/2001 VERSION-NR.: VNM	FOR ALL OTHER PARTS SEE XENTIA 72 M 72-420/8 DOLBY PART NO: 921949024000 ORDER NO: G.CL 7000 EDITION 9/2001 VERSION NO.: VNM

89

### XENTIA 72 M 72-420/8 DOLBY

POS. NR. MATERIAL-NR. BEZEICHNUNG  
POS. NO. PART NUMBER DESCRIPTION

POS. NR. MATERIAL-NR. BEZEICHNUNG  
POS. NO. PART NUMBER DESCRIPTION

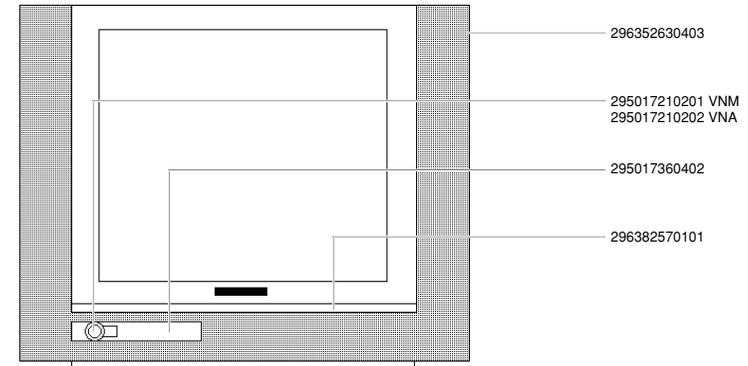

ÄNDERUNGEN VORBEHALTEN / SUBJECT TO ALTERATION

Es gelten die Vorschriften und Sicherheitshinweise gemäß dem Service Manual "Sicherheit", Mat.-Nummer 720108000000, sowie zusätzlich die eventuell abweichenden, landesspezifischen Vorschriften!



The regulations and safety instructions shall be valid as provided by the "Safety" Service Manual, part number 720108000000, as well as the respective national deviations.

ÄNDERUNGEN VORBEHALTEN / SUBJECT TO ALTERATION

### Ersatzteilliste Spare Parts List

6 / 2002

### XENTIA 72 M 72-420/8 DOLBY

MATERIAL-NR. / PART NO.: 921949027700 BESTELL-NR. / ORDER NO.: GCL7077 ELON METALLIC  
VERSION NR./VERSION NO.: VNA

POS. NR. POS. NO.	ABB. FIG.	MATERIAL-NR. PART NUMBER	ANZ. QTY.	BEZEICHNUNG (D)	DESCRIPTION (GB)
		921949027700		XENTIA 72 M 72-420/8 DOLBY ELON METALLIC KEIN E-TEIL	XENTIA 72 M 72-420/8 DOLBY ELON METALLIC NO SPARE PART
0050.000				PROGRAMM FLASH-EPROM DOWNLOAD: WWW.GRUNDIG.DE/ PRODUKTE/KONTAKT/HAENDLERSERVICE	PROGRAM FLASH EPROM DOWNLOAD: WWW.GRUNDIG.DE/ PRODUCTS/CONTACT/RESELLER SUPPORT
0201.000		191260469701	2	LAUTSPRECHER KOMBI	LOUDSPEAKER COMBI
0208.000		297006510104		ABDECKUNG DIGI-100	COVER DIGI-100
0300.000		296363880203		GEH-RUECKTEIL OFB	CABINET REAR PART SURFACE TREATED
0320.000		291102316405		TYPENAUFKLEBER VNA	TYPE LABEL SELF ADHESIVE VNA
WW.		291102886404		TYPENAUFKLEBER VNA	TYPE LABEL SELF ADHESIVE VNA
0950.000		292104087306		SHIFTSTECKER KPL 4W/330 OHM	SHIFT PLUG CPL 4W/330 OHM
0950.000		292104087606		SHIFTSTECKER KPL 5W/180 OHM	SHIFT PLUG CPL 5W/180 OHM
1100.000		830006824300		BILDROHR A 68 ESF002X43 PHILIPS	PICTURE TUBE A 68 ESF002X43 PHILIPS
1360.000	△	297033910600		NETZSCHALTER O.WISCHER	POWER SWITCH W/O WIPER
1370.000		295017210202		TASTENKNOPF NETZ KPL	KEY POWER CPL
1395.000		295017380109		AUFNAHME DRUCK KPL	HOLDER PRINT CPL
		219499410600		BEDIENUNGSANLEITUNG D	OPERATION INSTRUCTIONS D
		219499410700		BEDIENUNGSANLEITUNG F/I	OPERATION INSTRUCTIONS F/I
		219499410800		BEDIENUNGSANLEITUNG GB/NL	OPERATION INSTRUCTIONS GB/NL
		219499410900		BEDIENUNGSANLEITUNG E/P	OPERATION INSTRUCTIONS E/P
		219499411000		BEDIENUNGSANLEITUNG DK/FIN	OPERATION INSTRUCTIONS DK/FIN
		219499411100		BEDIENUNGSANLEITUNG S/N	OPERATION INSTRUCTIONS S/N
		720100305000		SERVICE MANUAL D/GB	SERVICE MANUAL D/GB
		720100305400		SERVICE MANUAL D/GB 4.ERGAENZUNG	SERVICE MANUAL D/GB 4TH SUPPLEMENT
		720100305500		SERVICE MANUAL D/GB 5.ERGAENZUNG	SERVICE MANUAL D/GB 5TH SUPPLEMENT
		720100305600		SERVICE MANUAL D/GB 6.ERGAENZUNG	SERVICE MANUAL D/GB 6TH SUPPLEMENT
		297040193200	X	CHASSIS-FS-STEREO DIGI 100 CUC 1838 KEIN E-TEIL	CHASSIS TV STEREO DIGI 100 CUC 1838 NO SPARE PART
				X = SIEHE GESONDERTE E-LISTE WW. = WAHLWEISE	X = SEE SEPARATE PARTS LIST WW. = OPTIONAL
				ALLE ANDEREN TEILE SIEHE E-LISTE XENTIA 72 M 72-420/8 DOLBY MAT.-NR: 921949027700 BESTELL-NR: GCL 7077 AUSGABE 1/2001 VERSION-NR.: VNM	FOR ALL OTHER PARTS SEE XENTIA 72 M 72-420/8 DOLBY PART NO: 921949027700 ORDER NO: GCL 7077 EDITION 1/2001 VERSION NO.: VNM

ÄNDERUNGEN VORBEHALTEN / SUBJECT TO ALTERATION

POS. NR. MATERIAL-NR. BEZEICHNUNG  
POS. NO. PART NUMBER DESCRIPTION

POS. NR. MATERIAL-NR. BEZEICHNUNG  
POS. NO. PART NUMBER DESCRIPTION

### XENTIA 72 M 72-420/8 DOLBY

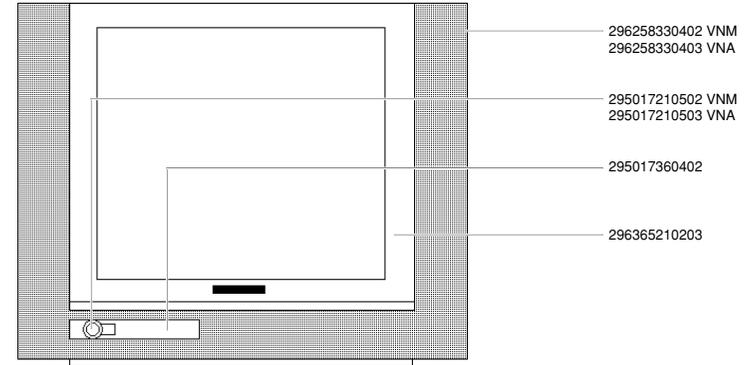

Es gelten die Vorschriften und Sicherheitshinweise gemäß dem Service Manual "Sicherheit", Mat.-Nummer 720108000000, sowie zusätzlich die eventuell abweichenden, landesspezifischen Vorschriften!



The regulations and safety instructions shall be valid as provided by the "Safety" Service Manual, part number 720108000000, as well as the respective national deviations.

ÄNDERUNGEN VORBEHALTEN / SUBJECT TO ALTERATION

# Ersatzteilliste Spare Parts List

## 6 / 2002

## XENTIA 72 M 72-430 DOLBY

MATERIAL-NR. / PART NO.: 921948014000 BESTELL-NR. / ORDER NO.: GCL6777 PROCON SILBER /PROCON SILVER  
VERSION NR./VERSION NO.: **VNA**

POS. NR. POS. NO.	ABB. FIG.	MATERIAL-NR. PART NUMBER	ANZ. QTY.	BEZEICHNUNG (D)	DESCRIPTION (GB)
		921948014000		XENTIA 72 FLAT MF 72-430 DOLBY PROCON SILBER KEIN E-TEIL	XENTIA 72 FLAT MF 72-430 DOLBY PROCON SILBER NO SPARE PART
0050.000				PROGRAMM FLASH-EPROM <b>DEUTSCHLAND</b> DOWNLOAD: HTTP://PARTNERWEB. GRUNDIG.DE/KUNDENDIENST PROGRAMM FLASH-EPROM <b>INTERNATIONAL</b> DOWNLOAD: WWW.GRUNDIG.DE/ PRODUKTE/KONTAKT/HAENDLERSERVICE	PROGRAM FLASH EPROM <b>GERMANY</b> DOWNLOAD: HTTP://PARTNERWEB. GRUNDIG.DE/KUNDENDIENST PROGRAM FLASH EPROM <b>INTERNATIONAL</b> DOWNLOAD: WWW.GRUNDIG.DE/ PRODUCTS/CONTACT/RESELLER SUPPORT
0200.000		296258330403	2	GEH-VORDETEIL OFB LS-KOMBI	CABINET FRONT PART SURFACE TREATED LOUDSPEAKER COMBI
0201.000		191260529701		ABDECKUNG LAUTSPRECHER	COVER LOUDSPEAKER
0206.000		296364430100		ABDECKUNG DIGI-100	COVER DIGI-100
0208.000		297006510103		TYPENAUFKLEBER VNA	TYPE LABEL SELF ADHESIVE VNA
0320.000		291103146402		TYPENAUFKLEBER VNA	TYPE LABEL SELF ADHESIVE VNA
WW.		291103136402		ENTMAGNETISIERUNGSSPULE	DEGAUSSING COIL CPL
0700.000		092461357806		<b>FUER BR A68LQP356X97</b>	<b>FOR PT A68LQP356X97</b>
0950.000		292104087306		SHIFTSTECKER KPL 4W/330 OHM	SHIFT PLUG CPL 4W/330 OHM
0950.000		292104087606		SHIFTSTECKER KPL 5W/180 OHM	SHIFT PLUG CPL 5W/180 OHM
1301.000		295017380108		AUFNAHME DRUCK KPL	HOLDER PRINT CPL
1370.000		295017210503		TASTENKNOPF NETZ KPL	KEY KNOB POWER CPL
		219489410900		BEDIENUNGSANLEITUNG D	OPERATION INSTRUCTIONS D
		219489411000		BEDIENUNGSANLEITUNG F/I	OPERATION INSTRUCTIONS F/I
		219489411100		BEDIENUNGSANLEITUNG GB/NL	OPERATION INSTRUCTIONS GB/NL
		720100305000		SERVICE MANUAL D/GB	SERVICE MANUAL D/GB
		720100305400		SERVICE MANUAL D/GB 4.ERGAENZUNG	SERVICE MANUAL D/GB 4TH SUPPLEMENT
		720100305500		SERVICE MANUAL D/GB 5.ERGAENZUNG	SERVICE MANUAL D/GB 5TH SUPPLEMENT
		720100305600		SERVICE MANUAL D/GB 6.ERGAENZUNG	SERVICE MANUAL D/GB 6TH SUPPLEMENT
		297040190100	X	CHASSIS-FS-STEREO DIGI 100 CUC 1838 KEIN E-TEIL <b>FUER BR A68ERF231X044</b>	CHASSIS TV STEREO DIGI 100 CUC 1838 NO SPARE PART <b>FOR PT A68ERF231X044</b>
		297040190200	X	CHASSIS-FS-STEREO DIGI 100 CUC 1838 KEIN E-TEIL <b>FUER BR A68LQP356X97</b>	CHASSIS TV STEREO DIGI 100 CUC 1838 NO SPARE PART <b>FOR PT A68LQP356X97</b>
				X = SIEHE GESONDERTE E-LISTE WW. = WAHLWEISE	X = SEE SEPARATE PARTS LIST WW. = OPTIONAL
				ALLE ANDEREN TEILE SIEHE E-LISTE XENTIA 72 FLAT MF 72-430 DOLBY MAT.-NR: 921948014000 BESTELL-NR: G.CL 6777 AUSGABE 4/2001 VERSION-NR.: <b>VNM</b>	FOR ALL OTHER PARTS SEE XENTIA 72 FLAT MF 72-430 DOLBY PART NO: 921948014000 ORDER NO: G.CL 6777 EDITION 4/2001 VERSION NO.: <b>VNM</b>

ÄNDERUNGEN VORBEHALTEN / SUBJECT TO ALTERATION

POS. NR. MATERIAL-NR. BEZEICHNUNG  
POS. NO. PART NUMBER DESCRIPTION

POS. NR. MATERIAL-NR. BEZEICHNUNG  
POS. NO. PART NUMBER DESCRIPTION

## XENTIA 72 M 72-430 DOLBY

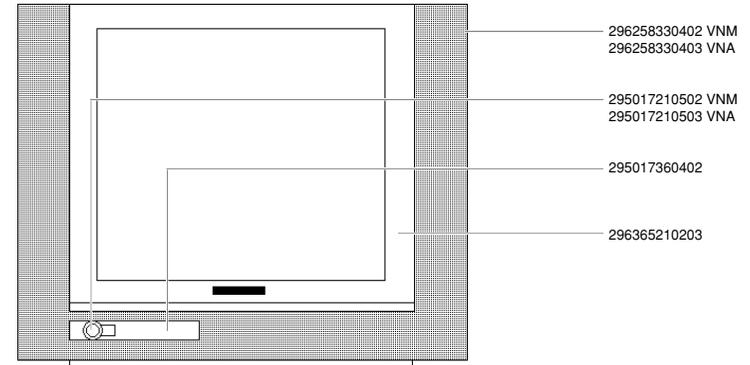

Es gelten die Vorschriften und Sicherheitshinweise gemäß dem Service Manual "Sicherheit", Mat.-Nummer 720108000000, sowie zusätzlich die eventuell abweichenden, landesspezifischen Vorschriften!



The regulations and safety instructions shall be valid as provided by the "Safety" Service Manual, part number 720108000000, as well as the respective national deviations.

ÄNDERUNGEN VORBEHALTEN / SUBJECT TO ALTERATION

### Ersatzteilliste Spare Parts List

6 / 2002

### XENTIA 72 FLAT MF 72-430 DOLBY

MATERIAL-NR. / PART NO.: 921948014000 BESTELL-NR. / ORDER NO.: GCL6777 PROCON SILBER/PROCON SILVER  
VERSION NR./VERSION NO.: VNX

POS. NR. POS. NO.	ABB. FIG.	MATERIAL-NR. PART NUMBER	ANZ. QTY.	BEZEICHNUNG D	DESCRIPTION GB
		921948014000		XENTIA 72 FLAT MF 72-430 DOLBY PROCON SILBER KEIN E-TEIL	XENTIA 72 FLAT MF 72-430 DOLBY PROCON SILBER NO SPARE PART
0050.000				PROGRAMM FLASH-EPROM <b>DEUTSCHLAND</b> DOWNLOAD: HTTP://PARTNERWEB. GRUNDIG.DE/KUNDENDIENST PROGRAMM FLASH-EPROM <b>INTERNATIONAL</b> DOWNLOAD: WWW.GRUNDIG.DE/ PRODUKTE/KONTAKT/HAENDLERSERVICE	PROGRAM FLASH EPROM <b>GERMANY</b> DOWNLOAD: HTTP://PARTNERWEB. GRUNDIG.DE/KUNDENDIENST PROGRAM FLASH EPROM <b>INTERNATIONAL</b> DOWNLOAD: WWW.GRUNDIG.DE/ PRODUCTS/CONTACT/RESSELLER SUPPORT
0200.000		296258330403	2	GEH-VORDETEIL OFB	CABINET FRONT PART SURF. TREATED
0201.000		191260529701		LS-KOMBI	LOUDSPEAKER COMBI
0206.000		296364430100		ABDECKUNG LAUTSPRECHER	COVER LOUDSPEAKER
0208.000		297006510104		ABDECKUNG DIGI-100	COVER DIGI-100
0320.000		291103136502		TYPENAUFKLEBER VNX	TYPE LABEL SELF ADHESIVE VNX
0950.000		292104087306		SHIFTSTECKER KPL 4W/330 OHM	SHIFT PLUG CPL 4W/330 OHM
0950.000		292104087606		SHIFTSTECKER KPL 5W/180 OHM	SHIFT PLUG CPL 5W/180 OHM
1100.000		830006835700		BILDROHR A 68 LTF356X96 TOSHIBA	PICTURE TUBE A 68 LTF356X96 TOSHIBA
1301.000		295017380109		AUFNAHME DRUCK KPL	HOLDER PRINT CPL
1370.000		295017210503		TASTENKNOPF NETZ KPL	KEY KNOB POWER CPL
219489410900			BEDIENUNGSANLEITUNG D	OPERATING INSTRUCTIONS D	
219489411000			BEDIENUNGSANLEITUNG F/I	OPERATING INSTRUCTIONS F/I	
219489411100			BEDIENUNGSANLEITUNG GB/NL	OPERATING INSTRUCTIONS GB/NL	
720100305000			SERVICE MANUAL D/GB	SERVICE MANUAL D/GB	
720100305400			SERVICE MANUAL D/GB 4.ERGAENZUNG	SERVICE MANUAL D/GB 4TH SUPPLEMENT	
720100305500			SERVICE MANUAL D/GB 5.ERGAENZUNG	SERVICE MANUAL D/GB 5TH SUPPLEMENT	
720100305600			SERVICE MANUAL D/GB 6.ERGAENZUNG	SERVICE MANUAL D/GB 6TH SUPPLEMENT	
297040197400			X	CHASSIS-FS-STEREO DIGI 100	CHASSIS TV STEREO DIGI 100
				CUC 1838 KEIN E-TEIL	CUC 1838 NO SPARE PART
				X = SIEHE GESONDERTE E-LISTE WW. = WAHLWEISE	X = SEE SEPARATE PARTS LIST WW. = OPTIONAL
				ALLE ANDEREN TEILE SIEHE E-LISTE XENTIA 72 FLAT MF 72-430 DOLBY MAT.-NR: 921948014000 BESTELL-NR: GCL 6777 AUSGABE 4/2001 VERSION-NR.: VNM	FOR ALL OTHER PARTS SEE XENTIA 72 FLAT MF 72-430 DOLBY PART NO: 921948014000 ORDER NO: GCL 6777 EDITION 4/2001 VERSION NO.: VNM

ÄNDERUNGEN VORBEHALTEN / SUBJECT TO ALTERATION

POS. NR. MATERIAL-NR. BEZEICHNUNG  
POS. NO. PART NUMBER DESCRIPTION

POS. NR. MATERIAL-NR. BEZEICHNUNG  
POS. NO. PART NUMBER DESCRIPTION

### XENTIA 72 FLAT M 72-430 DOLBY

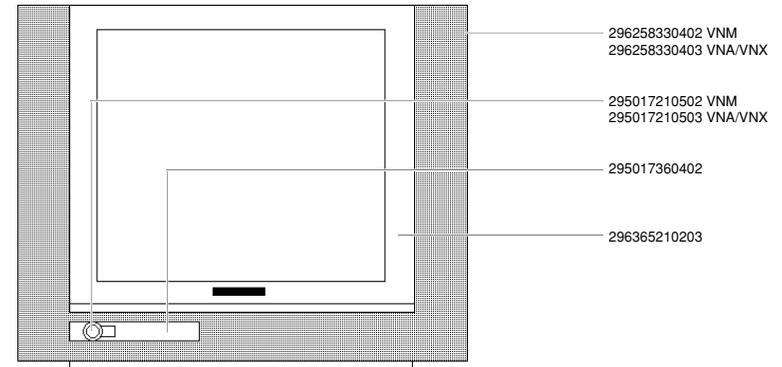

Es gelten die Vorschriften und Sicherheitshinweise gemäß dem Service Manual "Sicherheit", Mat.-Nummer 720108000000, sowie zusätzlich die eventuell abweichenden, landesspezifischen Vorschriften!



The regulations and safety instructions shall be valid as provided by the "Safety" Service Manual, part number 720108000000, as well as the respective national deviations.

ÄNDERUNGEN VORBEHALTEN / SUBJECT TO ALTERATION

MATERIAL-NR. / PART NO.: 921948024000 BESTELL-NR. / ORDER NO.: GCL6877 PROCON SILBER/PROCON SILVER  
VERSION NR./VERSION NO.: VNA

POS. NR. POS. NO.	ABB. FIG.	MATERIAL-NR. PART NUMBER	ANZ. QTY.	BEZEICHNUNG <b>(D)</b>	DESCRIPTION <b>(GB)</b>
		921948024000		XENTIA 72 FLAT MF 72-430/8 DOLBY PROCON SILBER KEIN E-TEIL	XENTIA 72 FLAT MF 72-430/8 DOLBY PROCON SILVER NO SPARE PART
0050.000				PROGRAMM FLASH-EPROM <b>DEUTSCHLAND</b> DOWNLOAD: HTTP://PARTNERWEB. GRUNDIG.DE/KUNDENDIENST PROGRAMM FLASH-EPROM <b>INTERNATIONAL</b> DOWNLOAD: WWW.GRUNDIG.DE/ PRODUKTE/KONTAKT/HAENDLERSERVICE	PROGRAM FLASH EPROM <b>GERMANY</b> DOWNLOAD: HTTP://PARTNERWEB. GRUNDIG.DE/KUNDENDIENST PROGRAM FLASH EPROM <b>INTERNATIONAL</b> DOWNLOAD: WWW.GRUNDIG.DE/ PRODUCTS/CONTACT/RESELLER SUPPORT
0200.000		296258330403	2	GEH-VORDE RTEIL OFB	CABINET FRONT PART SURF. TREATED
0201.000		191260529701		LS-KOMBI	LOUDSPEAKER COMBI
0206.000		296364430100		ABDECKUNG LAUTSPRECHER	COVER LOUDSPEAKER
0208.000		297006510103		ABDECKUNG DIGI-100	COVER DIGI-100
0320.000		291103166403		TYPENAUFKLEBER VNA	TYPE LABEL SELF ADHESIVE VNA
WW.		291103156403		TYPENAUFKLEBER VNA	TYPE LABEL SELF ADHESIVE VNA
0700.000		092461357806		ENTMAGNETISIERUNGSSPULE	DEGAUSSING COIL CPL
				FUER BR A68LQP356X97	FOR PT A68LQP356X97
0900.000	△	292014771101		FOKUS U.UG2-REGLER	FOCUS AND UG2-CONTROLLER
0950.000		292104087306		SHIFTSTECKER KPL 4W/330 OHM	SHIFT PLUG CPL 4W/330 OHM
0950.000		292104087606		SHIFTSTECKER KPL 5W/180 OHM	SHIFT PLUG CPL 5W/180 OHM
1301.000		295017380109		AUFNAHME DRUCK KPL	HOLDER PRINT CPL
1370.000		295017210503		TASTENKNOPF NETZ KPL	KEY KNOB POWER CPL
		219489410300		BEDIENUNGSANLEITUNG D	OPERATION INSTRUCTIONS D
		219489410400		BEDIENUNGSANLEITUNG F/I	OPERATION INSTRUCTIONS F/I
		219489410500		BEDIENUNGSANLEITUNG GB/NL	OPERATION INSTRUCTIONS GB/NL
		219489410600		BEDIENUNGSANLEITUNG E/P	OPERATION INSTRUCTIONS E/P
		219489410700		BEDIENUNGSANLEITUNG DK/FIN	OPERATION INSTRUCTIONS DK/FIN
		219489410800		BEDIENUNGSANLEITUNG S/N	OPERATION INSTRUCTIONS S/N
		720100305000		SERVICE MANUAL D/GB	SERVICE MANUAL D/GB
		720100305400		SERVICE MANUAL D/GB 4.ERGAENZUNG	SERVICE MANUAL D/GB 4TH SUPPLEMENT
		720100305500		SERVICE MANUAL D/GB 5.ERGAENZUNG	SERVICE MANUAL D/GB 5TH SUPPLEMENT
		720100305600		SERVICE MANUAL D/GB 6.ERGAENZUNG	SERVICE MANUAL D/GB 6TH SUPPLEMENT
		297040190300	X	CHASSIS-FS-STEREO DIGI 100 CUC 1838 KEIN E-TEIL <b>FUER BR A68ERF231X044</b>	CHASSIS TV STEREO DIGI 100 CUC 1838 NO SPARE PART <b>FOR PT A68ERF231X044</b>
		297040190400	X	CHASSIS-FS-STEREO DIGI 100 CUC 1838 KEIN E-TEIL <b>FUER BR A68LQP356X97</b>	CHASSIS TV STEREO DIGI 100 CUC 1838 NO SPARE PART <b>FOR PT A68LQP356X97</b>
				X = SIEHE GESONDERTE E-LISTE WW. = WAHLWEISE	X = SEE SEPARATE PARTS LIST WW. = OPTIONAL
				ALLE ANDEREN TEILE SIEHE E-LISTE XENTIA 72 FLAT MF 72-430/8 DOLBY MAT.-NR: 921948024000 BESTELL-NR: GCL6877 AUSGABE 4/2001 VERSION-NR.: VNM	FOR ALL OTHER PARTS SEE XENTIA 72 FLAT MF 72-430/8 DOLBY PART NO: 921948024000 ORDER NO: GCL6877 EDITION 4/2001 VERSION NO.: VNM

ÄNDERUNGEN VORBEHALTEN / SUBJECT TO ALTERATION

POS. NR. MATERIAL-NR. BEZEICHNUNG  
POS. NO. PART NUMBER DESCRIPTION

POS. NR. MATERIAL-NR. BEZEICHNUNG  
POS. NO. PART NUMBER DESCRIPTION

### XENTIA 72 FLAT MF 72-430/8 DOLBY

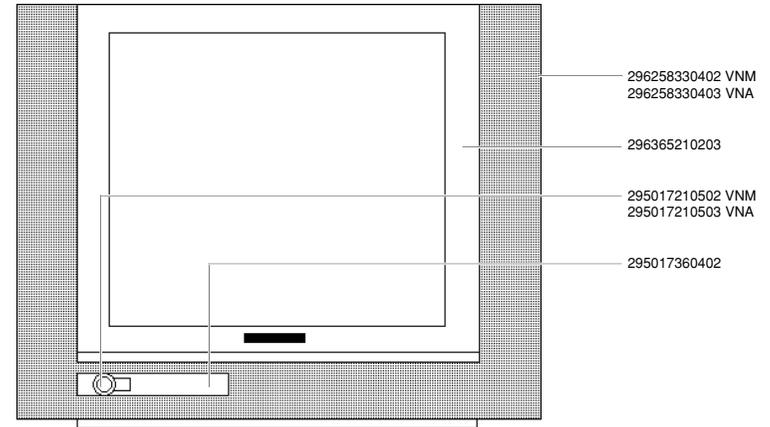

Es gelten die Vorschriften und Sicherheitshinweise gemäß dem Service Manual "Sicherheit", Mat.-Nummer 720108000000, sowie zusätzlich die eventuell abweichenden, landesspezifischen Vorschriften!



The regulations and safety instructions shall be valid as provided by the "Safety" Service Manual, part number 720108000000, as well as the respective national deviations.

ÄNDERUNGEN VORBEHALTEN / SUBJECT TO ALTERATION

Ersatzteilliste  
Spare Parts List

**GRUNDIG**

**TV**

**7 / 2002**

**XENTIA 72 FLAT MF 72-430/8 DOLBY**

MATERIAL-NR. / PART NO.: 921948024000 BESTELL-NR. / ORDER NO.: GCL6877 PROCON SILBER/PROCON SILVER  
VERSION NR./VERSION NO.: **VNX**

POS. NR. POS. NO.	ABB. FIG.	MATERIAL-NR. PART NUMBER	ANZ. QTY.	BEZEICHNUNG (D)	DESCRIPTION (GB)
		921948024000		XENTIA 72 FLAT MF 72-430/8 DOLBY PROCON SILBER KEIN E-TEIL	XENTIA 72 FLAT MF 72-430/8 DOLBY PROCON SILVER NO SPARE PART
0050.000				PROGRAMM FLASH-EPROM <b>DEUTSCHLAND</b> DOWNLOAD: HTTP://PARTNERWEB. GRUNDIG.DE/KUNDENDIENST PROGRAMM FLASH-EPROM <b>INTERNATIONAL</b> DOWNLOAD: WWW.GRUNDIG.DE/ PRODUKTE/KONTAKT/HAENDLERSERVICE	PROGRAM FLASH EPROM <b>GERMANY</b> DOWNLOAD: HTTP://PARTNERWEB. GRUNDIG.DE/KUNDENDIENST PROGRAM FLASH EPROM <b>INTERNATIONAL</b> DOWNLOAD: WWW.GRUNDIG.DE/ PRODUCTS/CONTACT/RESSELLER SUPPORT
0200.000		296258330403	2	GEH-VORDERTEIL OFB	CABINET FRONT PART SURF. TREATED
0201.000		191260529701		LS-KOMBI	LOUDSPEAKER COMBI
0206.000		296364430100		ABDECKUNG LAUTSPRECHER	COVER LOUDSPEAKER
0208.000		297006510104		ABDECKUNG DIGI-100	COVER DIGI-100
0320.000		291103156503		TYPENAUFKLEBER VNX	TYPE LABEL SELF ADHESIVE VNX
0700.000		092461357806		ENTMAGNETISIERUNGSSPULE	DEGAUSSING COIL CPL
0950.000		292104087306		SHIFTSTECKER KPL 4W/330 OHM	SHIFT PLUG CPL 4W/330 OHM
0950.000		292104087606		SHIFTSTECKER KPL 5W/180 OHM	SHIFT PLUG CPL 5W/180 OHM
1100.000		830006835700		BILDROHR A 68 LTF356X96 TOSHIBA	PICTURE TUBE A 68 LTF356X96 TOSHIBA
1301.000		295017380109		AUFNAHME DRUCK KPL	HOLDER PRINT CPL
1370.000		295017210503		TASTENKNOPF NETZ KPL	KEY KNOB POWER CPL
		219489410300		BEDIENUNGSANLEITUNG D	OPERATION INSTRUCTIONS D
		219489410400		BEDIENUNGSANLEITUNG F/I	OPERATION INSTRUCTIONS F/I
		219489410500		BEDIENUNGSANLEITUNG GB/NL	OPERATION INSTRUCTIONS GB/NL
		219489410600		BEDIENUNGSANLEITUNG E/P	OPERATION INSTRUCTIONS E/P
		219489410700		BEDIENUNGSANLEITUNG DK/FIN	OPERATION INSTRUCTIONS DK/FIN
		219489410800		BEDIENUNGSANLEITUNG S/N	OPERATION INSTRUCTIONS S/N
		720100305000		SERVICE MANUAL D/GB	SERVICE MANUAL D/GB
		720100305400		SERVICE MANUAL D/GB 4.ERGAENZUNG	SERVICE MANUAL D/GB 4TH SUPPLEMENT
		720100305500		SERVICE MANUAL D/GB 5.ERGAENZUNG	SERVICE MANUAL D/GB 5TH SUPPLEMENT
		720100305600		SERVICE MANUAL D/GB 6.ERGAENZUNG	SERVICE MANUAL D/GB 6TH SUPPLEMENT
		297040197300	X	CHASSIS-FS-STEREO DIGI 100 CUC 1838 KEIN E-TEIL  X = SIEHE GESONDERTE E-LISTE  ALLE ANDEREN TEILE SIEHE E-LISTE XENTIA 72 FLAT MF 72-430/8 DOLBY MAT.-NR: 921948024000 BESTELL-NR: GCL6877 AUSGABE 4/2001 VERSION-NR.: <b>VNM</b>	CHASSIS TV STEREO DIGI 100 CUC 1838 NO SPARE PART  X = SEE SEPARATE PARTS LIST  FOR ALL OTHER PARTS SEE XENTIA 72 FLAT MF 72-430/8 DOLBY PART NO: 921948024000 ORDER NO: GCL6877 EDITION 4/2001 VERSION NO.: <b>VNM</b>

ÄNDERUNGEN VORBEHALTEN / SUBJECT TO ALTERATION

POS. NR. MATERIAL-NR. BEZEICHNUNG  
POS. NO. PART NUMBER DESCRIPTION

POS. NR. MATERIAL-NR. BEZEICHNUNG  
POS. NO. PART NUMBER DESCRIPTION

**XENTIA 72 FLAT MF 72-430/8 DOLBY**

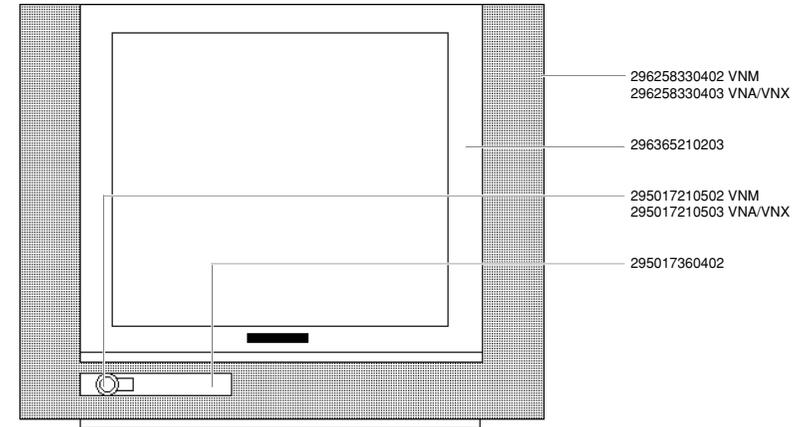

Es gelten die Vorschriften und Sicherheitshinweise gemäß dem Service Manual "Sicherheit", Mat.-Nummer 720108000000, sowie zusätzlich die eventuell abweichenden, landesspezifischen Vorschriften!



The regulations and safety instructions shall be valid as provided by the "Safety" Service Manual, part number 720108000000, as well as the respective national deviations.

ÄNDERUNGEN VORBEHALTEN / SUBJECT TO ALTERATION

### Ersatzteilliste Spare Parts List

### 7 / 2002

### M 72-798 DOLBY

MATERIAL-NR. / PART NO.: 921984017200 BESTELL-NR. / ORDER NO.: GCM5200 AGANA-GRAU/AGANA GREY  
VERSION NR./VERSION NO.: VNA

POS. NR. POS. NO.	ABB. FIG.	MATERIAL-NR. PART NUMBER	ANZ. QTY.	BEZEICHNUNG (D)	DESCRIPTION (GB)
		921984017200		M 72-798 DOLBY AGANA-GRAU KEIN E-TEIL	M 72-798 DOLBY AGANA GREY NO SPARE PART
0050.000				PROGRAMM FLASH-EPROM <b>DEUTSCHLAND</b> DOWNLOAD: HTTP://PARTNERWEB. GRUNDIG.DE/KUNDENDIENST PROGRAMM FLASH-EPROM <b>INTERNATIONAL</b> DOWNLOAD: WWW.GRUNDIG.DE/ PRODUKTE/KONTAKT/HAENDLERSERVICE	PROGRAM FLASH EPROM <b>GERMANY</b> DOWNLOAD: HTTP://PARTNERWEB. GRUNDIG.DE/KUNDENDIENST PROGRAM FLASH EPROM <b>INTERNATIONAL</b> DOWNLOAD: WWW.GRUNDIG.DE/ PRODUCTS/CONTACT/RESELLER SUPPORT
0200.000		296354620302		GEH-VORDETEIL DRUCK KPL	CABINET FRONT PART PRINT CPL
0229.000		296321140102		EMBLEM GRUNDIG	EMBLEM GRUNDIG
0312.000		297006513102		ABDECKUNG M.KOAX-KABEL	COVER W.COAX CABLE
0320.000		291104336403		TYPENAUFKLEBER VNA	TYPE LABEL SELF ADHESIVE VNA
0950.000		292104087306		SHIFTSTECKER KPL 4W/330 OHM	SHIFT PLUG CPL 4W/330 OHM
0950.000		292104087606		SHIFTSTECKER KPL 5W/180 OHM	SHIFT PLUG CPL 5W/180 OHM
		219849410200		BEDIENUNGSANLEITUNG D	OPERATION INSTRUCTIONS D
		219849410300		BEDIENUNGSANLEITUNG F/I	OPERATION INSTRUCTIONS F/I
		219849410400		BEDIENUNGSANLEITUNG GB/NL	OPERATION INSTRUCTIONS GB/NL
		720100305000		SERVICE MANUAL D/GB	SERVICE MANUAL D/GB
		720100305400		SERVICE MANUAL D/GB 4.ERGAENZUNG	SERVICE MANUAL D/GB 4TH SUPPLEMENT
		720100305500		SERVICE MANUAL D/GB 5.ERGAENZUNG	SERVICE MANUAL D/GB 5TH SUPPLEMENT
		720100305600		SERVICE MANUAL D/GB 6.ERGAENZUNG	SERVICE MANUAL D/GB 6TH SUPPLEMENT
		297040115200	X	CHASSIS-FS-STEREO DIGI 100 CUC 1838 KEIN E-TEIL	CHASSIS TV STEREO DIGI 100 CUC 1838 NO SPARE PART
				X = SIEHE GESONDERTE E-LISTE WW. = WAHLWEISE	X = SEE SEPARATE PARTS LIST WW. = OPTIONAL
				ALLE ANDEREN TEILE SIEHE E-LISTE M 72-798 DOLBY MAT.-NR: 921984017200 M 72-798 DOLBY BESTELL-NR: GCM5200 AUSGABE 3/2001 VERSION-NR.: VNM	FOR ALL OTHER PARTS SEE M 72-798 DOLBY PART NO: 921984017200 M 72-798 DOLBY ORDER NO: GCM5200 EDITION 3/2001 VERSION NO.: VNM

### M 72-798 DOLBY

POS. NR. MATERIAL-NR. BEZEICHNUNG  
POS. NO. PART NUMBER DESCRIPTION

POS. NR. MATERIAL-NR. BEZEICHNUNG  
POS. NO. PART NUMBER DESCRIPTION

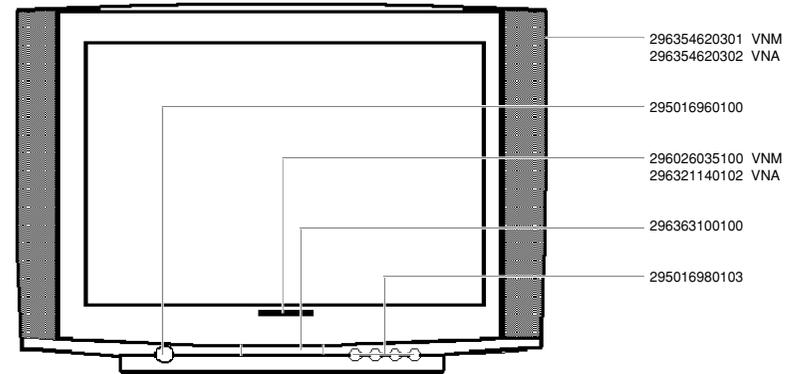

Es gelten die Vorschriften und Sicherheitshinweise gemäß dem Service Manual "Sicherheit", Mat.-Nummer 720108000000, sowie zusätzlich die eventuell abweichenden, landesspezifischen Vorschriften!



The regulations and safety instructions shall be valid as provided by the "Safety" Service Manual, part number 720108000000, as well as the respective national deviations.

ÄNDERUNGEN VORBEHALTEN / SUBJECT TO ALTERATION

ÄNDERUNGEN VORBEHALTEN / SUBJECT TO ALTERATION

## Ersatzteilliste Spare Parts List

### TV

#### 9 / 2002

#### M 72-798 DOLBY

MATERIAL-NR. / PART NO.: 921984017200 BESTELL-NR. / ORDER NO.: GCM5200 AGANA-GRAU/AGANA GREY  
VERSION NR./VERSION NO.: VNX

POS. NR. POS. NO.	ABB. FIG.	MATERIAL-NR. PART NUMBER	ANZ. QTY.	BEZEICHNUNG ①	DESCRIPTION ②
		921984017200		M 72-798 DOLBY AGANA-GRAU KEIN E-TEIL	M 72-798 DOLBY AGANA GREY NO SPARE PART
0200.000		296354620302		GEH-VORDERTEIL DRUCK KPL	CABINET FRONT PART PRINT CPL
0229.000		296321140102		EMBLEM GRUNDIG	EMBLEM GRUNDIG
0312.000		297006513102		ABDECKUNG M.KOAX-KABEL	COVER W.COAX CABLE
0320.000		291104336503		TYPENAUFKL.VNX	TYPE LABEL VNX
0950.000		292104087606		SHIFTSTECKER KPL 5W/180 OHM	SHIFT PLUG CPL 5W/180 OHM
0950.000		292104087306		SHIFTSTECKER KPL 4W/330 OHM	SHIFT PLUG CPL 4W/330 OHM
1100.000		830006824300		BILDROHR A 68 ESF002X43 PHILIPS PICTURE TUBE A 68 ESF002X43 PHILIPS	PICTURE TUBE BOARD
2300.000		293051223100	X	BILDROHRPLATTE	PICTURE TUBE BOARD
219849410200				BEDIENUNGSANLEITUNG D	OPERATION INSTRUCTIONS D
219849410300				BEDIENUNGSANLEITUNG F/I	OPERATION INSTRUCTIONS F/I
219849410400				BEDIENUNGSANLEITUNG GB/NL	OPERATION INSTRUCTIONS GB/NL
720100305000				SERVICE MANUAL D/GB	SERVICE MANUAL D/GB
720100305400				SERVICE MANUAL D/GB 4.ERGAENZUNG	SERVICE MANUAL D/GB 4TH SUPPLEMENT
720100305500				SERVICE MANUAL D/GB 5.ERGAENZUNG	SERVICE MANUAL D/GB 5TH SUPPLEMENT
720100305600				SERVICE MANUAL D/GB 6.ERGAENZUNG	SERVICE MANUAL D/GB 6TH SUPPLEMENT
297040192300			X	CHASSIS-FS-STEREO DIGI 100 CUC 1838 KEIN E-TEIL	CHASSIS TV STEREO DIGI 100 CUC 1838 NO SPARE PART
				X = SIEHE GESONDERTE E-LISTE	X = SEE SEPARATE PARTS LIST
				ALLE ANDEREN TEILE SIEHE E-LISTE M 72-798 DOLBY MAT.-NR.: 921984017200 BESTELL-NR.: GCM5200 AUSGABE 3/2001 VERSION-NR.: VNM	FOR ALL OTHER PARTS SEE M 72-798 DOLBY PART NO.: 921984017200 ORDER NO.: GCM5200 EDITION 3/2001 VERSION NO.: VNM

## Ersatzteilliste Spare Parts List

### TV

#### 7 / 2002

#### SEDANCE 72 M 72-2110 DOLBY

MATERIAL-NR. / PART NO.: 921990017500 BESTELL-NR. / ORDER NO.: GCM2700 SCHWARZ/BLACK  
VERSION NR./VERSION NO.: VNA

POS. NR. POS. NO.	ABB. FIG.	MATERIAL-NR. PART NUMBER	ANZ. QTY.	BEZEICHNUNG ①	DESCRIPTION ②
		921990017500		SEDANCE 72 M 72-2110 DOLBY SCHWARZ KEIN E-TEIL	SEDANCE 72 M 72-2110 DOLBY BLACK NO SPARE PART
0050.000				PROGRAMM FLASH-EPROM DOWNLOAD: WWW.GRUNDIG.DE/ PRODUKTE/KONTAKT/HAENDLERSERVICE	PROGRAM FLASH EPROM DOWNLOAD: WWW.GRUNDIG.DE/ PRODUCTS/CONTACT/RESELLER SUPPORT
0200.000		296354620102		GEH-VORDERTEIL DRUCK KPL	CABINET FRONT PART PRINT CPL
0229.000		296321140102		EMBLEM GRUNDIG	EMBLEM GRUNDIG
0320.000		291104246403		TYPENAUFKLEBER VNA	TYPE LABEL VNA
0950.000		292104087606		SHIFTSTECKER KPL 5 W/180 OHM	SHIFT PLUG CPL 5 W/180 OHM
0950.000		292104087306		SHIFTSTECKER KPL 4 W/330 OHM	SHIFT PLUG CPL 4 W/330 OHM
2300.000		293051223100	X	BILDROHRPLATTE	PICT.TUBE BOARD
219909410900				BEDIENUNGSANLEITUNG D	OPERATING INSTRUCTIONS D
219909411000				BEDIENUNGSANLEITUNG F/I	OPERATING INSTRUCTIONS F/I
219909411100				BEDIENUNGSANLEITUNG GB/NL	OPERATING INSTRUCTIONS GB/NL
720100305000				SERVICE MANUAL D/GB	SERVICE MANUAL D/GB
720100305400				SERVICE MANUAL D/GB 4.ERGAENZUNG	SERVICE MANUAL D/GB 4TH SUPPLEMENT
720100305500				SERVICE MANUAL D/GB 5.ERGAENZUNG	SERVICE MANUAL D/GB 5TH SUPPLEMENT
720100305600				SERVICE MANUAL D/GB 6.ERGAENZUNG	SERVICE MANUAL D/GB 6TH SUPPLEMENT
297040115200			X	CHASSIS-FS-STEREO CUC 1838 DIGI 100 KEIN E-TEIL	CHASSIS TV STEREO CUC 1838 DIGI 100 NO SPARE PART
				X=SIEHE GESONDERTE E-LISTE	X=SEE SEPARATE PARTS LIST
				ALLE WEITEREN TEILE SIEHE E-LISTE SEDANCE 72 M 72-2110 DOLBY SCHWARZ MAT.-NR.: 921990017500 BESTELL-NR.: GCM2700 AUSGABE 2/2001 VERSION NR.: VNM	FOR ALL OTHER PARTS SEE SEDANCE 72 M 72-2110 DOLBY BLACK PART NO.: 921990017500 ORDER NR.: GCM2700 EDITION 2/2001 VERSION NO.: VNM

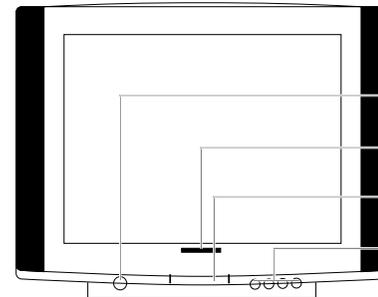

296354620101 VNM  
296354620102 VNA

295016960100

296026035100 VNM  
296321140102 VNA

296363100100

295016980103

Es gelten die Vorschriften und Sicherheitshinweise gemäß dem Service Manual "Sicherheit", Mat.-Nummer 720108000000, sowie zusätzlich die eventuell abweichenden, landesspezifischen Vorschriften!



The regulations and safety instructions shall be valid as provided by the "Safety" Service Manual, part number 720108000000, as well as the respective national deviations.

ÄNDERUNGEN VORBEHALTEN / SUBJECT TO ALTERATION

ÄNDERUNGEN VORBEHALTEN / SUBJECT TO ALTERATION

Ersatzteilliste  
Spare Parts List

7 / 2002

SEDANCE 72 M 72-2110 DOLBY

MATERIAL-NR. / PART NO.: 921990017500 BESTELL-NR. / ORDER NO.: GCM2700 SCHWARZ/BLACK  
VERSION NR./VERSION NO.: VNX

POS. NR. POS. NO.	ABB. FIG.	MATERIAL-NR. PART NUMBER	ANZ. QTY.	BEZEICHNUNG D	DESCRIPTION GB
		921990017500		SEDANCE 72 M 72-2110 DOLBY SCHWARZ KEIN E-TEIL	SEDANCE 72 M 72-2110 DOLBY BLACK NO SPARE PART
0050.000				PROGRAMM FLASH-EPROM DOWNLOAD: WWW.GRUNDIG.DE/ PRODUKTE/KONTAKT/HAENDLERSERVICE	PROGRAM FLASH EPROM DOWNLOAD: WWW.GRUNDIG.DE/ PRODUCTS/CONTACT/RESELLER SUPPORT
0200.000 0229.000 0320.000 0950.000 0950.000 2300.000 2400.000 2410.000		296354620102 296321140102 291104246503 292104087606 292104087306 293051223100 296420660300 720086745000		GEH-VORDE RTEIL DRUCK KPL EMBLEM GRUNDIG TYPENAUFKLEBER VNX SHIFTSTECKER KPL 5 W/180 OHM SHIFTSTECKER KPL 4 W/330 OHM X BILDROHRPLATTE TP 150 C FERNBEDIENUNG SCHWARZ DECKEL BATTERIE TP 150 C	CABINET FRONT PART PRINT CPL EMBLEM GRUNDIG TYPE LABEL VNX SHIFT PLUG CPL 5 W/180 OHM SHIFT PLUG CPL 4 W/330 OHM PICT.TUBE BOARD TP 150 C REMOTE CONTROL BLACK BATTERY LID TP 150 C
219909412000 219909412100 219909412200 720100305000 720100305400 720100305500 720100305600				BEDIENUNGSANLEITUNG D BEDIENUNGSANLEITUNG F/I BEDIENUNGSANLEITUNG GB/NL SERVICE MANUAL D/GB SERVICE MANUAL D/GB 4.ERGAENZUNG SERVICE MANUAL D/GB 5.ERGAENZUNG SERVICE MANUAL D/GB 6.ERGAENZUNG	OPERATING INSTRUCTIONS D OPERATING INSTRUCTIONS F/I OPERATING INSTRUCTIONS GB/NL SERVICE MANUAL D/GB SERVICE MANUAL D/GB 4TH SUPPLEMENT SERVICE MANUAL D/GB 5TH SUPPLEMENT SERVICE MANUAL D/GB 6TH SUPPLEMENT
297040115200			X	CHASSIS-FS-STEREO CUC 1838 DIGI 100 KEIN E-TEIL	CHASSIS TV STEREO CUC 1838 DIGI 100 NO SPARE PART
				X=SIEHE GESONDERTE E-LISTE	X=SEE SEPARATE PARTS LIST
				ALLE WEITEREN TEILE SIEHE E-LISTE SEDANCE 72 M 72-2110 DOLBY SCHWARZ MAT.-NR.: 921990017500 BESTELL-NR.: GCM2700 AUSGABE 2/2001 VERSION NR.: VNM	FOR ALL OTHER PARTS SEE SEDANCE 72 M 72-2110 DOLBY BLACK PART NO: 921990017500 ORDER NR: GCM2700 EDITION 2/2001 VERSION NO.: VNM

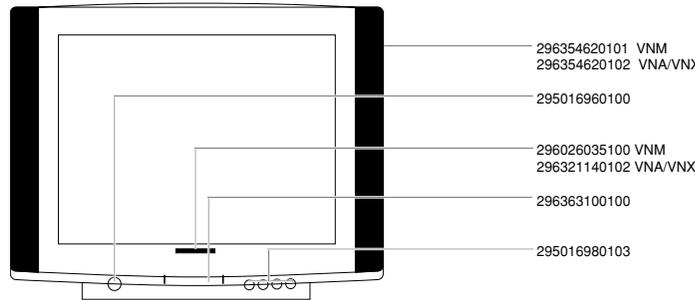

ÄNDERUNGEN VORBEHALTEN / SUBJECT TO ALTERATION

Ersatzteilliste  
Spare Parts List

7 / 2002

SEDANCE 72 M 72-2110 DOLBY

MATERIAL-NR. / PART NO.: 921990017500 BESTELL-NR. / ORDER NO.: GCM2700 SCHWARZ/BLACK  
VERSION NR./VERSION NO.: VNG

POS. NR. POS. NO.	ABB. FIG.	MATERIAL-NR. PART NUMBER	ANZ. QTY.	BEZEICHNUNG D	DESCRIPTION GB
		921990017500		SEDANCE 72 M 72-2110 DOLBY SCHWARZ KEIN E-TEIL	SEDANCE 72 M 72-2110 DOLBY BLACK NO SPARE PART
0050.000				PROGRAMM FLASH-EPROM DOWNLOAD: WWW.GRUNDIG.DE/ PRODUKTE/KONTAKT/HAENDLERSERVICE	PROGRAM FLASH EPROM DOWNLOAD: WWW.GRUNDIG.DE/ PRODUCTS/CONTACT/RESELLER SUPPORT
0200.000 0229.000 0300.000 0320.000 0950.000 0950.000 1100.000 2300.000		296354620102 296321140102 296319818715 291104246603 292104087606 292104087306 830006824300 293051223100		GEH-VORDE RTEIL DRUCK KPL EMBLEM GRUNDIG GEH-RUECKTEIL TYPENAUFKLEBER VNG SHIFTSTECKER KPL 5 W/180 OHM SHIFTSTECKER KPL 4 W/330 OHM X BILDR.A68ESF002X43 BILDROHRPLATTE	CABINET FRONT PART PRINT CPL EMBLEM GRUNDIG CABINET REAR PART TYPE LABEL VNG SHIFT PLUG CPL 5 W/180 OHM SHIFT PLUG CPL 4 W/330 OHM PICT.TUBE A68ESF002X43 PICT.TUBE BOARD
2400.000 2410.000		296420660300 720086745000		TP 150 C FERNBEDIENUNG SCHWARZ DECKEL BATTERIE TP 150 C	TP 150 C REMOTE CONTROL BLACK BATTERY LID TP 150 C
219909412000 219909412100 219909412200 720100305000 720100305400 720100305500 720100305600				BEDIENUNGSANLEITUNG D BEDIENUNGSANLEITUNG F/I BEDIENUNGSANLEITUNG GB/NL SERVICE MANUAL D/GB SERVICE MANUAL D/GB 4.ERGAENZUNG SERVICE MANUAL D/GB 5.ERGAENZUNG SERVICE MANUAL D/GB 6.ERGAENZUNG	OPERATING INSTRUCTIONS D OPERATING INSTRUCTIONS F/I OPERATING INSTRUCTIONS GB/NL SERVICE MANUAL D/GB SERVICE MANUAL D/GB 4TH SUPPLEMENT SERVICE MANUAL D/GB 5TH SUPPLEMENT SERVICE MANUAL D/GB 6TH SUPPLEMENT
297040192300			X	CHASSIS-FS-STEREO CUC 1838 DIGI 100 KEIN E-TEIL	CHASSIS TV STEREO CUC 1838 DIGI 100 NO SPARE PART
				X=SIEHE GESONDERTE E-LISTE	X=SEE SEPARATE PARTS LIST
				ALLE WEITEREN TEILE SIEHE E-LISTE SEDANCE 72 M 72-2110 DOLBY SCHWARZ MAT.-NR.: 921990017500 BESTELL-NR.: GCM2700 AUSGABE 2/2001 VERSION NR.: VNM	FOR ALL OTHER PARTS SEE SEDANCE 72 M 72-2110 DOLBY BLACK PART NO: 921990017500 ORDER NR: GCM2700 EDITION 2/2001 VERSION NO.: VNM

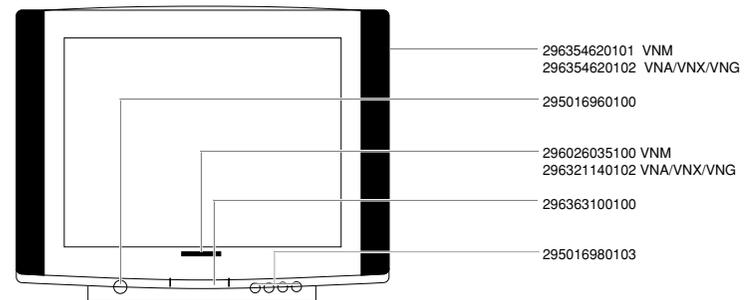

ÄNDERUNGEN VORBEHALTEN / SUBJECT TO ALTERATION

## Ersatzteilliste Spare Parts List

### 7 / 2002

### SEDANCE 72 M 72-2110 MV/DOLBY

MATERIAL-NR. / PART NO.: 921990029200 BESTELL-NR. / ORDER NO.: GCM1900 TITANE  
VERSION NR./VERSION NO.: **VNA**

POS. NR. POS. NO.	ABB. FIG.	MATERIAL-NR. PART NUMBER	ANZ. QTY.	BEZEICHNUNG <b>(D)</b>	DESCRIPTION <b>(GB)</b>
		921990029200		SEDANCE 72 M 72-2110 MV/DOLBY TITANE KEIN E-TEIL	SEDANCE 72 M 72-2110 MV/DOLBY TITANE NO SPARE PART
0050.000				PROGRAMM FLASH-EPROM DOWNLOAD: WWW.GRUNDIG.DE/ PRODUKTE/KONTAKT/HAENDLERSERVICE	PROGRAM FLASH EPROM DOWNLOAD: WWW.GRUNDIG.DE/ PRODUCTS/CONTACT/RESELLER SUPPORT
0200.000		296354620402		GEH-VORDERTEIL DRUCK KPL	CABINET FRONT PART PRINT CPL
0229.000		296321140102		EMBLEM GRUNDIG	EMBLEM GRUNDIG
0300.000		296319810602		GEH-RUECKTEIL OFB	CABINET REAR PART SURFACE TREATED
0320.000		291104236403		TYPENAUFKLEBER VNA	TYPE LABEL VNA
0950.000		292104087606		SHIFTSTECKER KPL 5 W/180 OHM	SHIFT PLUG CPL 5 W/180 OHM
0950.000		292104087306		SHIFTSTECKER KPL 4 W/330 OHM	SHIFT PLUG CPL 4 W/330 OHM
2300.000		293051223100	X	BILDROHRPLATTE	PICT.TUBE BOARD
219909410300				BEDIENUNGSANLEITUNG D	OPERATING INSTRUCTIONS D
219909410400				BEDIENUNGSANLEITUNG F/I	OPERATING INSTRUCTIONS F/I
219909410500				BEDIENUNGSANLEITUNG GB/NL	OPERATING INSTRUCTIONS GB/NL
219909410600				BEDIENUNGSANLEITUNG E/P	OPERATING INSTRUCTIONS E/P
219909410700				BEDIENUNGSANLEITUNG DK/FIN	OPERATING INSTRUCTIONS DK/FIN
219909410800				BEDIENUNGSANLEITUNG S/N	OPERATING INSTRUCTIONS S/N
720100305000				SERVICE MANUAL D/GB	SERVICE MANUAL D/GB
720100305400				SERVICE MANUAL D/GB 4.ERGAENZUNG	SERVICE MANUAL D/GB 4TH SUPPLEMENT
720100305500				SERVICE MANUAL D/GB 5.ERGAENZUNG	SERVICE MANUAL D/GB 5TH SUPPLEMENT
720100305600				SERVICE MANUAL D/GB 6.ERGAENZUNG	SERVICE MANUAL D/GB 6TH SUPPLEMENT
297040115300			X	CHASSIS-FS-STEREO CUC 1838 DIGI 100 KEIN E-TEIL	CHASSIS TV STEREO CUC 1838 DIGI 100 NO SPARE PART
				X=SIHE GESONDERTE E-LISTE	X=SEE SEPARATE PARTS LIST
				ALLE WEITEREN TEILE SIEHE E-LISTE SEDANCE 72 M 72-2110 MV/DOLBY TITANE MAT.-NR.: 921990029200 BESTELL-NR.: GCM1900 AUSGABE 2/2001 VERSION NR.: <b>VNM</b>	FOR ALL OTHER PARTS SEE SEDANCE 72 M 72-2110 MV/DOLBY TITANE PART NO.: 921990029200 ORDER NR: GCM1900 EDITION 2/2001 VERSION NO.: <b>VNM</b>

ÄNDERUNGEN VORBEHALTEN / SUBJECT TO ALTERATION

POS. NR. MATERIAL-NR. BEZEICHNUNG  
POS. NO. PART NUMBER DESCRIPTION

POS. NR. MATERIAL-NR. BEZEICHNUNG  
POS. NO. PART NUMBER DESCRIPTION

### SEDANCE 72 M 72-2110 MV/DOLBY

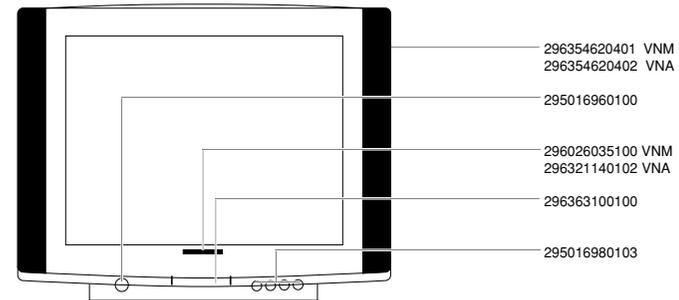

Es gelten die Vorschriften und Sicherheitshinweise gemäß dem Service Manual "Sicherheit", Mat.-Nummer 720108000000, sowie zusätzlich die eventuell abweichenden, landesspezifischen Vorschriften!



The regulations and safety instructions shall be valid as provided by the "Safety" Service Manual, part number 720108000000, as well as the respective national deviations.

ÄNDERUNGEN VORBEHALTEN / SUBJECT TO ALTERATION

# Ersatzteilliste Spare Parts List

## 7 / 2002

# GRUNDIG

# TV

### SEDANCE 72 M 72-2110 MV/DOLBY

MATERIAL-NR. / PART NO.: 921990029200 BESTELL-NR. / ORDER NO.: GCM1900 TITANE  
VERSION NR./VERSION NO.: VNX

POS. NR. POS. NO.	ABB. FIG.	MATERIAL-NR. PART NUMBER	ANZ. QTY.	BEZEICHNUNG (D)	DESCRIPTION (GB)
		921990029200		SEDANCE 72 M 72-2110 MV/DOLBY TITANE KEIN E-TEIL	SEDANCE 72 M 72-2110 MV/DOLBY TITANE NO SPARE PART
0050.000				PROGRAMM FLASH-EPROM <b>DEUTSCHLAND</b> DOWNLOAD: HTTP://PARTNERWEB. GRUNDIG.DE/KUNDENDIENST	PROGRAM FLASH EPROM <b>GERMANY</b> DOWNLOAD: HTTP://PARTNERWEB. GRUNDIG.DE/KUNDENDIENST
0050.000				PROGRAMM FLASH-EPROM <b>INTERNATIONAL</b> DOWNLOAD: WWW.GRUNDIG.DE/ PRODUKTE/KONTAKT/HAENDLERSERVICE	PROGRAM FLASH EPROM <b>INTERNATIONAL</b> DOWNLOAD: WWW.GRUNDIG.DE/ PRODUCTS/CONTACT/RESELLER SUPPORT
0200.000		296354620402		GEH-VORDETEIL DRUCK KPL	CABINET FRONT PART PRINT CPL
0229.000		296321140102		EMBLEM GRUNDIG	EMBLEM GRUNDIG
0300.000		296319810602		GEH-RUECKTEIL OFB	CABINET REAR PART SURFACE TREATED
0320.000		291104236503		TYPENAUFKLEBER VNX	TYPE LABEL VNX
0950.000		292104087606		SHIFTSTECKER KPL 5 W/180 OHM	SHIFT PLUG CPL 5 W/180 OHM
0950.000		292104087306		SHIFTSTECKER KPL 4 W/330 OHM	SHIFT PLUG CPL 4 W/330 OHM
2300.000		293051223100	X	BILDROHRPLATTE	PICT.TUBE BOARD
2400.000		296420660300		TP 150 C FERNBEDIENUNG SCHWARZ	TP 150 C REMOTE CONTROL BLACK
2410.000		720086745000		DECKEL BATTERIE TP 150 C	BATTERY LID TP 150 C
219909411300				BEDIENUNGSANLEITUNG D	OPERATING INSTRUCTIONS D
219909411400				BEDIENUNGSANLEITUNG F/I	OPERATING INSTRUCTIONS F/I
219909411500				BEDIENUNGSANLEITUNG GB/NL	OPERATING INSTRUCTIONS GB/NL
219909411600				BEDIENUNGSANLEITUNG E/P	OPERATING INSTRUCTIONS E/P
219909411700				BEDIENUNGSANLEITUNG DK/FIN	OPERATING INSTRUCTIONS DK/FIN
219909411800				BEDIENUNGSANLEITUNG S/N	OPERATING INSTRUCTIONS S/N
720100305000				SERVICE MANUAL D/GB	SERVICE MANUAL D/GB
720100305400				SERVICE MANUAL D/GB 4.ERGAENZUNG	SERVICE MANUAL D/GB 4TH SUPPLEMENT
720100305500				SERVICE MANUAL D/GB 5.ERGAENZUNG	SERVICE MANUAL D/GB 5TH SUPPLEMENT
720100305600				SERVICE MANUAL D/GB 6.ERGAENZUNG	SERVICE MANUAL D/GB 6TH SUPPLEMENT
297040115300			X	CHASSIS-FS-STEREO CUC 1838 DIGI 100 KEIN E-TEIL	CHASSIS TV STEREO CUC 1838 DIGI 100 NO SPARE PART
				X-SIEHE GESONDERTE E-LISTE	X=SEE SEPARATE PARTS LIST
				ALLE WEITEREN TEILE SIEHE E-LISTE SEDANCE 72 M 72-2110 MV/DOLBY TITANE MAT.-NR.: 921990029200 BESTELL-NR.: GCM1900 AUSGABE 2/2001 VERSION NR.: VNM	FOR ALL OTHER PARTS SEE SEDANCE 72 M 72-2110 MV/DOLBY TITANE PART NO.: 921990029200 ORDER NR.: GCM1900 EDITION 2/2001 VERSION NO.: VNM

ÄNDERUNGEN VORBEHALTEN / SUBJECT TO ALTERATION

POS. NR. MATERIAL-NR. BEZEICHNUNG  
POS. NO. PART NUMBER DESCRIPTION

POS. NR. MATERIAL-NR. BEZEICHNUNG  
POS. NO. PART NUMBER DESCRIPTION

### SEDANCE 72 M 72-2110 MV/DOLBY

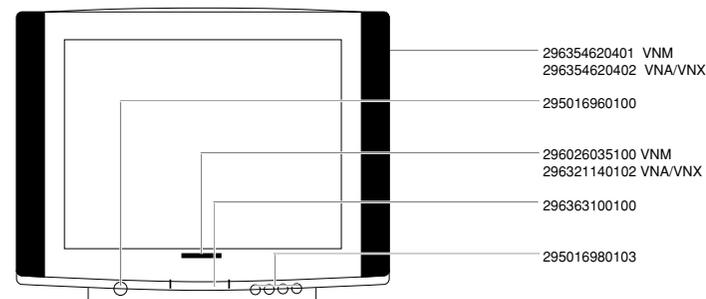

Es gelten die Vorschriften und Sicherheitshinweise gemäß dem Service Manual "Sicherheit", Mat.-Nummer 720108000000, sowie zusätzlich die eventuell abweichenden, landesspezifischen Vorschriften!



The regulations and safety instructions shall be valid as provided by the "Safety" Service Manual, part number 720108000000, as well as the respective national deviations.

ÄNDERUNGEN VORBEHALTEN / SUBJECT TO ALTERATION

# Ersatzteilliste Spare Parts List

7 / 2002

# GRUNDIG

# TV

## SEDANCE 72 M 72-2110 MV/DOLBY

MATERIAL-NR. / PART NO.: 921990029200 BESTELL-NR. / ORDER NO.: GCM1900 TITANE  
VERSION NR./VERSION NO.: VNG

POS. NR. POS. NO.	ABB. FIG.	MATERIAL-NR. PART NUMBER	ANZ. QTY.	BEZEICHNUNG (D)	DESCRIPTION (GB)
		921990029200		SEDANCE 72 M 72-2110 MV/DOLBY TITANE KEIN E-TEIL	SEDANCE 72 M 72-2110 MV/DOLBY TITANE NO SPARE PART
0050.000				PROGRAMM FLASH-EPROM <b>DEUTSCHLAND</b> DOWNLOAD: HTTP://PARTNERWEB. GRUNDIG.DE/KUNDENDIENST	PROGRAM FLASH EPROM <b>GERMANY</b> DOWNLOAD: HTTP://PARTNERWEB. GRUNDIG.DE/KUNDENDIENST
0050.000				PROGRAMM FLASH-EPROM <b>INTERNATIONAL</b> DOWNLOAD: WWW.GRUNDIG.DE/ PRODUKTE/KONTAKT/HAENDLERSERVICE	PROGRAM FLASH EPROM <b>INTERNATIONAL</b> DOWNLOAD: WWW.GRUNDIG.DE/ PRODUCTS/CONTACT/RESELLER SUPPORT
0200.000		296354620402		GEH-VORDERTEIL DRUCK KPL	CABINET FRONT PART PRINT CPL
0229.000		296321140102		EMBLEM GRUNDIG	EMBLEM GRUNDIG
0300.000		296319810602		GEH-RUECKTEIL OFB	CABINET REAR PART SURFACE TREATED
0320.000		291104236603		TYPENAUFKLEBER VNG	TYPE LABEL VNG
0950.000		292104087606		SHIFTSTECKER KPL 5 W/180 OHM	SHIFT PLUG CPL 5 W/180 OHM
0950.000		292104087306		SHIFTSTECKER KPL 4 W/330 OHM	SHIFT PLUG CPL 4 W/330 OHM
1100.000		830006824300		BILDR.A68ESF002X43	PICT.TUBE A68ESF002X43
2300.000		293051223100	X	BILDROHRPLATTE	PICT.TUBE BOARD
2400.000		296420660300		TP 150 C FERNBEDIENUNG SCHWARZ	TP 150 C REMOTE CONTROL BLACK
2410.000		720086745000		DECKEL BATTERIE TP 150 C	BATTERY LID TP 150 C
		219909411300		BEDIENUNGSANLEITUNG D	OPERATING INSTRUCTIONS D
		219909411400		BEDIENUNGSANLEITUNG F/I	OPERATING INSTRUCTIONS F/I
		219909411500		BEDIENUNGSANLEITUNG GB/NL	OPERATING INSTRUCTIONS GB/NL
		219909411600		BEDIENUNGSANLEITUNG E/P	OPERATING INSTRUCTIONS E/P
		219909411700		BEDIENUNGSANLEITUNG DK/FIN	OPERATING INSTRUCTIONS DK/FIN
		219909411800		BEDIENUNGSANLEITUNG S/N	OPERATING INSTRUCTIONS S/N
		720100305000		SERVICE MANUAL D/GB	SERVICE MANUAL D/GB
		720100305400		SERVICE MANUAL D/GB 4.ERGAENZUNG	SERVICE MANUAL D/GB 4TH SUPPLEMENT
		720100305500		SERVICE MANUAL D/GB 5.ERGAENZUNG	SERVICE MANUAL D/GB 5TH SUPPLEMENT
		720100305600		SERVICE MANUAL D/GB 6.ERGAENZUNG	SERVICE MANUAL D/GB 6TH SUPPLEMENT
		297040192200	X	CHASSIS-FS-STEREO CUC 1838 DIGI 100 KEIN E-TEIL	CHASSIS TV STEREO CUC 1838 DIGI 100 NO SPARE PART
				X=SIEMHE GESONDERTE E-LISTE	X=SEE SEPARATE PARTS LIST
				ALLE WEITEREN TEILE SIEHE E-LISTE SEDANCE 72 M 72-2110 MV/DOLBY TITANE MAT.-NR.: 921990029200 BESTELL-NR.: GCM1900 AUSGABE 2/2001 VERSION NR.: VNM	FOR ALL OTHER PARTS SEE SEDANCE 72 M 72-2110 MV/DOLBY TITANE PART NO.: 921990029200 ORDER NR.: GCM1900 EDITION 2/2001 VERSION NO.: VNM

ÄNDERUNGEN VORBEHALTEN / SUBJECT TO ALTERATION

POS. NR. MATERIAL-NR. BEZEICHNUNG  
POS. NO. PART NUMBER DESCRIPTION

POS. NR. MATERIAL-NR. BEZEICHNUNG  
POS. NO. PART NUMBER DESCRIPTION

## SEDANCE 72 M 72-2110 MV/DOLBY

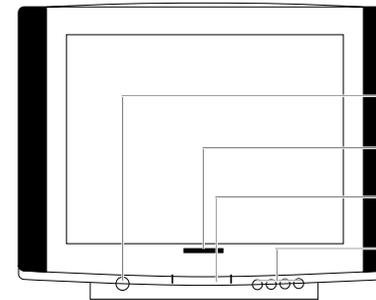

296354620401 VNM  
296354620402 VNA/VNX/VNG  
295016960100  
296026035100 VNM  
296321140102 VNA/VNX/VNG  
296363100100  
295016980103

Es gelten die Vorschriften und Sicherheitshinweise gemäß dem Service Manual "Sicherheit", Mat.-Nummer 720108000000, sowie zusätzlich die eventuell abweichenden, landesspezifischen Vorschriften!



The regulations and safety instructions shall be valid as provided by the "Safety" Service Manual, part number 720108000000, as well as the respective national deviations.

ÄNDERUNGEN VORBEHALTEN / SUBJECT TO ALTERATION

## Ersatzteilliste Spare Parts List

### 7 / 2002

### ELEGANCE 72 FLAT MF 72-3110 DOLBY

MATERIAL-NR. / PART NO.: 921993014000 BESTELL-NR. / ORDER NO.: GCM4700 PROCON SILBER/PROCON SILVER  
VERSION NR./VERSION NO.: VNA

POS. NR. POS. NO.	ABB. FIG.	MATERIAL-NR. PART NUMBER	ANZ. QTY.	BEZEICHNUNG (D)	DESCRIPTION (GB)
		921993014000		ELEGANCE 72 FLAT MF 72-3110 DOLBY PROCON SILBER KEIN E-TEIL	ELEGANCE 72 FLAT MF 72-3110 DOLBY PROCON SILVER NO SPARE PART
0050.000				PROGRAMM FLASH-EPROM <b>DEUTSCHLAND</b> DOWNLOAD: HTTP://PARTNERWEB. GRUNDIG.DE/KUNDENDIENST	PROGRAM FLASH EPROM <b>GERMANY</b> DOWNLOAD: HTTP://PARTNERWEB. GRUNDIG.DE/KUNDENDIENST
0050.000				PROGRAMM FLASH-EPROM <b>INTERNATIONAL</b> DOWNLOAD: WWW.GRUNDIG.DE/ PRODUKTE/KONTAKT/HAENDLERSERVICE	PROGRAM FLASH EPROM <b>INTERNATIONAL</b> DOWNLOAD: WWW.GRUNDIG.DE/ PRODUCTS/CONTACT/RESELLER SUPPORT
0225.000		295017623102		KLAPPE DRUCK KPL	FLAP PRINT CPL
0240.000		293033904200		KOPFHUERERBUCHSE 3,5mm O.SCHALTER	HEADPHONE SOCKET 3,5mm W/O SWITCH
0241.000		293031680503		CINCH-BUCHSE 3-FACH FBAS/NF L,R	CINCH SOCKET 3 FOLD FBAS/AF L,R
0320.000		291104096403		TYPENAUFKLEBER VNA	TYPE LABEL SELF ADHESIVE VNA
0350.000		296383650101	6	ZWISCHENSTUECK RUECKWANDBEFEST.	INTERMEDIATE PIECE REAR PANEL FIXING
0950.000		292104087306		SHIFTSTECKER KPL 4W/330 OHM	SHIFT PLUG CPL 4W/330 OHM
0950.000		292104087606		SHIFTSTECKER KPL 5W/180	OHM SHIFT PLUG CPL 5W/180 OHM
		219939410300		BEDIENUNGSANLEITUNG D	OPERATION INSTRUCTIONS D
		219939410400		BEDIENUNGSANLEITUNG F/I	OPERATION INSTRUCTIONS F/I
		219939410500		BEDIENUNGSANLEITUNG GB/NL	OPERATION INSTRUCTIONS GB/NL
		720100305000		SERVICE MANUAL D/GB	SERVICE MANUAL D/GB
		720100305400		SERVICE MANUAL D/GB 4.ERGAENZUNG	SERVICE MANUAL D/GB 4TH SUPPLEMENT
		720100305500		SERVICE MANUAL D/GB 5.ERGAENZUNG	SERVICE MANUAL D/GB 5TH SUPPLEMENT
		720100305600		SERVICE MANUAL D/GB 6.ERGAENZUNG	SERVICE MANUAL D/GB 6TH SUPPLEMENT
		297040191000	X	CHASSIS-FS-STEREO DIGI 100 CUC 1838 KEIN E-TEIL	CHASSIS TV STEREO DIGI 100 CUC 1838 NO SPARE PART
				X = SIEHE GESONDERTE E-LISTE	X = SEE SEPARATE PARTS LIST
				ALLE ANDEREN TEILE SIEHE E-LISTE ELEGANCE 72 MF 72-3110 DOLBY MAT.-NR: 921993014000 BESTELL-NR: GCM4700 AUSGABE 9/2001 VERSION-NR.: VNM	FOR ALL OTHER PARTS SEE ELEGANCE 72 MF 72-3110 DOLBY PART NO: 921993014000 ORDER NO: GCM4700 EDITION 9/2001 VERSION NO.: VNM

ÄNDERUNGEN VORBEHALTEN / SUBJECT TO ALTERATION

POS. NR. MATERIAL-NR. BEZEICHNUNG  
POS. NO. PART NUMBER DESCRIPTION

POS. NR. MATERIAL-NR. BEZEICHNUNG  
POS. NO. PART NUMBER DESCRIPTION

### ELEGANCE 72 FLAT MF 72-3110 DOLBY

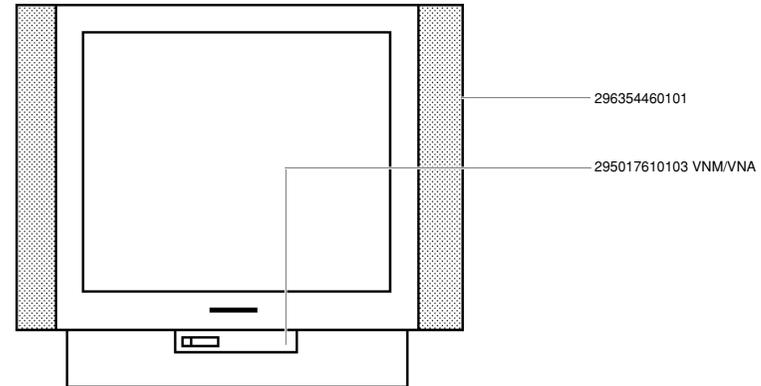

Es gelten die Vorschriften und Sicherheitshinweise gemäß dem Service Manual "Sicherheit", Mat.-Nummer 720108000000, sowie zusätzlich die eventuell abweichenden, landesspezifischen Vorschriften!



The regulations and safety instructions shall be valid as provided by the "Safety" Service Manual, part number 720108000000, as well as the respective national deviations.

ÄNDERUNGEN VORBEHALTEN / SUBJECT TO ALTERATION

## Ersatzteilliste Spare Parts List

### 7 / 2002

### ELEGANCE 72 FLAT MF 72-3110 DOLBY

MATERIAL-NR. / PART NO.: 921993014000 BESTELL-NR. / ORDER NO.: GCM4700 PROCON SILBER/PROCON SILVER  
VERSION NR./VERSION NO.: VNX

POS. NR. POS. NO.	ABB. FIG.	MATERIAL-NR. PART NUMBER	ANZ. QTY.	BEZEICHNUNG (D)	DESCRIPTION (GB)
		921993014000		ELEGANCE 72 FLAT MF 72-3110 DOLBY PROCON SILBER KEIN E-TEIL	ELEGANCE 72 FLAT MF 72-3110 DOLBY PROCON SILVER NO SPARE PART
0050.000				PROGRAMM FLASH-EPROM <b>DEUTSCHLAND</b> DOWNLOAD: HTTP://PARTNERWEB. GRUNDIG.DE/KUNDENDIENST PROGRAMM FLASH-EPROM	PROGRAM FLASH EPROM <b>GERMANY</b> DOWNLOAD: HTTP://PARTNERWEB. GRUNDIG.DE/KUNDENDIENST PROGRAM FLASH EPROM
0050.000				<b>INTERNATIONAL</b> DOWNLOAD: WWW.GRUNDIG.DE/ PRODUKTE/KONTAKT/HAENDLERSERVICE	<b>INTERNATIONAL</b> DOWNLOAD: WWW.GRUNDIG.DE/ PRODUCTS/CONTACT/RESELLER SUPPORT
0210.000		295017610104		BEDIENEINSATZ MONTIERT KPL	CONTROL INSERT MOUNTED CPL
0225.000		295017623102		KLAPPE DRUCK KPL	FLAP PRINT CPL
0240.000		293033904200		KOPFHOERERBUCHSE 3,5mm O.SCHALTER	HEADPHONE SOCKET 3.5mm W/O SWITCH
0241.000		293031680503		CINCH-BUCHSE 3-FACH FBAS/NF L,R	CINCH SOCKET 3 FOLD FBAS/AF L,R
0320.000		291105256502		TYPENAUFKLEBER VNX	TYPE LABEL SELF ADHESIVE VNX
0950.000		292104087306		SHIFTSTECKER KPL 4W/330 OHM	SHIFT PLUG CPL 4W/330 OHM
0950.000		292104087606		SHIFTSTECKER KPL 5W/180 OHM	SHIFT PLUG CPL 5W/180 OHM
1100.000	△	830006835700		BILDROHR A 68 LTF356X96 TOSHIBA	PICTURE TUBE A 68 LTF356X96 TOSHIBA
2300.000		293051223200	X	BILDROHRPLATTE	PICTURE TUBE
		219939410300		BEDIENUNGSANLEITUNG D	OPERATION INSTRUCTIONS D
		219939410400		BEDIENUNGSANLEITUNG F/I	OPERATION INSTRUCTIONS F/I
		219939410500		BEDIENUNGSANLEITUNG GB/NL	OPERATION INSTRUCTIONS GB/NL
		720100305000		SERVICE MANUAL D/GB	SERVICE MANUAL D/GB
		720100305400		SERVICE MANUAL D/GB 4.ERGAENZUNG	SERVICE MANUAL D/GB 4TH SUPPLEMENT
		720100305500		SERVICE MANUAL D/GB 5.ERGAENZUNG	SERVICE MANUAL D/GB 5TH SUPPLEMENT
		720100305600		SERVICE MANUAL D/GB 6.ERGAENZUNG	SERVICE MANUAL D/GB 6TH SUPPLEMENT
		297040197500	X	CHASSIS-FS-STEREO DIGI 100 CUC 1838 KEIN E-TEIL	CHASSIS TV STEREO DIGI 100 CUC 1838 NO SPARE PART
				X = SIEHE GESONDERTE E-LISTE	X = SEE SEPARATE PARTS LIST
				ALLE ANDEREN TEILE SIEHE E-LISTE ELEGANCE 72 MF 72-3110 DOLBY MAT.-NR.: 921993014000 BESTELL-NR.: GCM4700 AUSGABE 9/2001 VERSION-NR.: VNM	FOR ALL OTHER PARTS SEE ELEGANCE 72 MF 72-3110 DOLBY PART NO.: 921993014000 ORDER NO.: GCM4700 EDITION 9/2001 VERSION NO.: VNM

ÄNDERUNGEN VORBEHALTEN / SUBJECT TO ALTERATION

POS. NR. MATERIAL-NR. BEZEICHNUNG  
POS. NO. PART NUMBER DESCRIPTION

POS. NR. MATERIAL-NR. BEZEICHNUNG  
POS. NO. PART NUMBER DESCRIPTION

### ELEGANCE 72 FLAT MF 72-3110 DOLBY

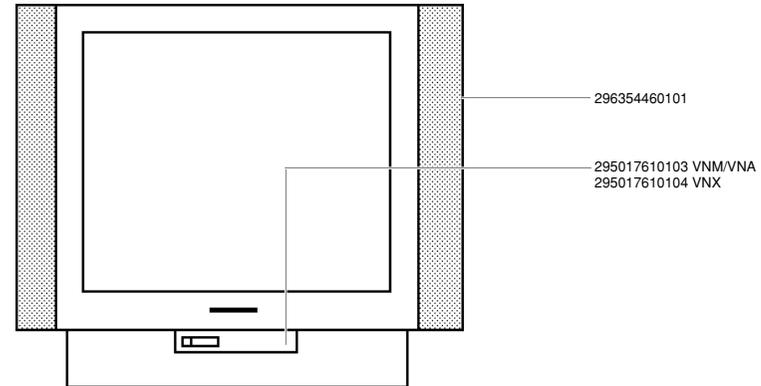

Es gelten die Vorschriften und Sicherheitshinweise gemäß dem Service Manual "Sicherheit", Mat.-Nummer 720108000000, sowie zusätzlich die eventuell abweichenden, landesspezifischen Vorschriften!



The regulations and safety instructions shall be valid as provided by the "Safety" Service Manual, part number 720108000000, as well as the respective national deviations.

ÄNDERUNGEN VORBEHALTEN / SUBJECT TO ALTERATION

# Ersatzteilliste Spare Parts List

## 7 / 2002

## ELEGANCE 72 MF 72-3110/8 DOLBY

MATERIAL-NR. / PART NO.: 921993024000 BESTELL-NR. / ORDER NO.: GCL8600 PROCON SILBER/PROCON SILVER  
VERSION NR./VERSION NO.: VNA

POS. NR. POS. NO.	ABB. FIG.	MATERIAL-NR. PART NUMBER	ANZ. QTY.	BEZEICHNUNG (D)	DESCRIPTION (GB)
		921993024000		ELEGANCE 72 MF 72-3110/8 DOLBY PROCON SILBER KEIN E-TEIL	ELEGANCE 72 MF 72-3110/8 DOLBY PROCON SILVER NO SPARE PART
0050.000				PROGRAMM FLASH-EPROM <b>DEUTSCHLAND</b> DOWNLOAD: HTTP://PARTNERWEB. GRUNDIG.DE/KUNDENDIENST	PROGRAM FLASH EPROM <b>GERMANY</b> DOWNLOAD: HTTP://PARTNERWEB. GRUNDIG.DE/KUNDENDIENST
0050.000				PROGRAMM FLASH-EPROM <b>INTERNATIONAL</b> DOWNLOAD: WWW.GRUNDIG.DE/ PRODUKTE/KONTAKT/HAENDLERSERVICE	PROGRAM FLASH EPROM <b>INTERNATIONAL</b> DOWNLOAD: WWW.GRUNDIG.DE/ PRODUCTS/CONTACT/RESELLER SUPPORT
0225.000		295017623102		KLAPPE DRUCK KPL	FLAP PRINT CPL
0240.000		293033904200		KOPFHÖRERBUCHSE 3,5mm O.SCHALTER	HEADPHONE SOCKET 3,5mm W/O SWITCH
0241.000		293031680503		CINCH-BUCHSE 3-FACH FBAS/NF L,R	CINCH SOCKET 3 FOLD FBAS/AF L,R
0320.000		291104106404		TYPENAUFKLEBER VNA	TYPE LABEL SELF ADHESIVE VNA
0350.000		296383650101	6	ZWISCHENSTUECK RUECKWANDBEFEST.	INTERMEDIATE PIECE REAR PANAL FIXING
0950.000		292104087306		SHIFTSTECKER KPL 4W/330 OHM	SHIFT PLUG CPL 4W/330 OHM
0950.000		292104087606		SHIFTSTECKER KPL 5W/180	OHM SHIFT PLUG CPL 5W/180 OHM
		219939410601		BEDIENUNGSANLEITUNG D	OPERATION INSTRUCTIONS D
		219939410701		BEDIENUNGSANLEITUNG F/I	OPERATION INSTRUCTIONS F/I
		219939410801		BEDIENUNGSANLEITUNG GB/NL	OPERATION INSTRUCTIONS GB/NL
		219939410901		BEDIENUNGSANLEITUNG E/P	OPERATION INSTRUCTIONS E/P
		219939411001		BEDIENUNGSANLEITUNG DK/FIN	OPERATION INSTRUCTIONS DK/FIN
		219939411101		BEDIENUNGSANLEITUNG S/N	OPERATION INSTRUCTIONS S/N
		720100305000		SERVICE MANUAL D/GB	SERVICE MANUAL D/GB
		720100305400		SERVICE MANUAL D/GB 4.ERGAENZUNG	SERVICE MANUAL D/GB 4TH SUPPLEMENT
		720100305500		SERVICE MANUAL D/GB 5.ERGAENZUNG	SERVICE MANUAL D/GB 5TH SUPPLEMENT
		720100305600		SERVICE MANUAL D/GB 6.ERGAENZUNG	SERVICE MANUAL D/GB 6TH SUPPLEMENT
		297040191100	X	CHASSIS-FS-STEREO DIGI 100 CUC 1838 KEIN E-TEIL	CHASSIS TV STEREO DIGI 100 CUC 1838 NO SPARE PART
				X = SIEHE GESONDERTE E-LISTE	X = SEE SEPARATE PARTS LIST
				ALLE ANDEREN TEILE SIEHE E-LISTE ELEGANCE 72 MF 72-3110/8 DOLBY MAT.-NR.: 921993024000 BESTELL-NR.: GCL8600 AUSGABE 8/2001 VERSION-NR.: VNM	FOR ALL OTHER PARTS SEE ELEGANCE 72 MF 72-3110/8 DOLBY PART NO.: 921993024000 ORDER NO.: GCL8600 EDITION 8/2001 VERSION NO.: VNM

ÄNDERUNGEN VORBEHALTEN / SUBJECT TO ALTERATION

# GRUNDIG

# TV

POS. NR. MATERIAL-NR. BEZEICHNUNG  
POS. NO. PART NUMBER DESCRIPTION

POS. NR. MATERIAL-NR. BEZEICHNUNG  
POS. NO. PART NUMBER DESCRIPTION

## ELEGANCE 72 MF 72-3110/8 DOLBY

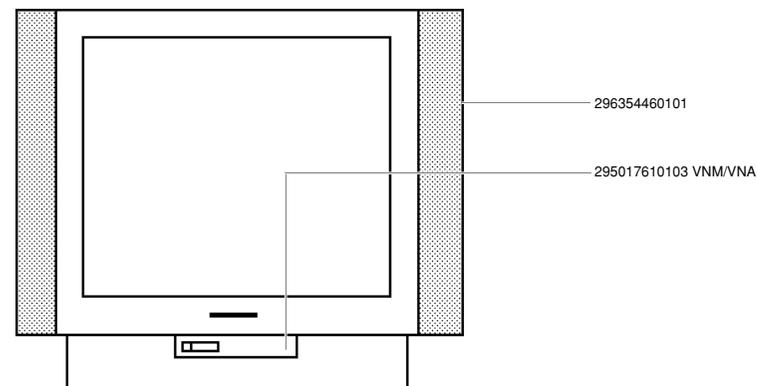

Es gelten die Vorschriften und Sicherheitshinweise gemäß dem Service Manual "Sicherheit", Mat.-Nummer 720108000000, sowie zusätzlich die eventuell abweichenden, landesspezifischen Vorschriften!



The regulations and safety instructions shall be valid as provided by the "Safety" Service Manual, part number 720108000000, as well as the respective national deviations.

ÄNDERUNGEN VORBEHALTEN / SUBJECT TO ALTERATION

### Ersatzteilliste Spare Parts List

7 / 2002

### ELEGANCE 72 MF 72-3110/8 DOLBY

MATERIAL-NR. / PART NO.: 921993024000 BESTELL-NR. / ORDER NO.: GCL8600 PROCON SILBER/PROCON SILVER  
VERSION NR./VERSION NO.: VNX

POS. NR. POS. NO.	ABB. FIG.	MATERIAL-NR. PART NUMBER	ANZ. QTY.	BEZEICHNUNG (D)	DESCRIPTION (GB)
		921993024000		ELEGANCE 72 MF 72-3110/8 DOLBY PROCON SILBER KEIN E-TEIL	ELEGANCE 72 MF 72-3110/8 DOLBY PROCON SILVER NO SPARE PART
0050.000				PROGRAMM FLASH-EPROM <b>DEUTSCHLAND</b> DOWNLOAD: HTTP://PARTNERWEB. GRUNDIG.DE/KUNDENDIENST PROGRAMM FLASH-EPROM	PROGRAM FLASH EPROM <b>GERMANY</b> DOWNLOAD: HTTP://PARTNERWEB. GRUNDIG.DE/KUNDENDIENST PROGRAM FLASH EPROM
0050.000				<b>INTERNATIONAL</b> DOWNLOAD: WWW.GRUNDIG.DE/ PRODUKTE/KONTAKT/HAENDLERSERVICE	<b>INTERNATIONAL</b> DOWNLOAD: WWW.GRUNDIG.DE/ PRODUCTS/CONTACT/RESELLER SUPPORT
0225.000		295017623102		KLAPPE DRUCK KPL	FLAP PRINT CPL
0240.000		293033904200		KOPFHOERERBUCHSE 3,5mm O.SCHALTER	HEADPHONE SOCKET 3,5mm W/O SWITCH
0241.000		293031680503		CINCH-BUCHSE 3-FACH FBAS/NF L,R	CINCH SOCKET 3 FOLD FBAS/AF L,R
0312.000		297006510104		ABDECKUNG DIGI-100	COVER DIGI-100
0320.000		2911105266504		TYPENAUFKLEBER VNX	TYPE LABEL SELF ADHESIVE VNX
0350.000		296383650101	6	ZWISCHENSTUECK RUECKWANDBEFEST.	INTERMEDIATE PIECE REAR PANEL FIXING
0950.000		292104087306		SHIFTSTECKER KPL 4W/330 OHM	SHIFT PLUG CPL 4W/330 OHM
0950.000		292104087606		SHIFTSTECKER KPL 5W/180	OHM SHIFT PLUG CPL 5W/180 OHM
1100.000	△	830006835700		BILDROHR A 68 LTF356X96 TOSHIBA	PICTURE TUBE A 68 LTF356X96 TOSHIBA
1300.000		295017610104		BEDIENEINSATZ MONTIERT KPL	CONTROL INSERT MOUNTED CPL
2300.000		293051223200	X	BILDROHRPLATTE	PICTURE TUBE BOARD
2500.000		219939410601		BEDIENUNGSANLEITUNG D	OPERATION INSTRUCTIONS D
		219939410701		BEDIENUNGSANLEITUNG F/I	OPERATION INSTRUCTIONS F/I
		219939410801		BEDIENUNGSANLEITUNG GB/NL	OPERATION INSTRUCTIONS GB/NL
		219939410901		BEDIENUNGSANLEITUNG E/P	OPERATION INSTRUCTIONS E/P
		219939411001		BEDIENUNGSANLEITUNG DK/FIN	OPERATION INSTRUCTIONS DK/FIN
		219939411101		BEDIENUNGSANLEITUNG S/N	OPERATION INSTRUCTIONS S/N
		720100305000		SERVICE MANUAL D/GB	SERVICE MANUAL D/GB
		720100305400		SERVICE MANUAL D/GB 4.ERGAENZUNG	SERVICE MANUAL D/GB 4TH SUPPLEMENT
		720100305500		SERVICE MANUAL D/GB 5.ERGAENZUNG	SERVICE MANUAL D/GB 5TH SUPPLEMENT
		720100305600		SERVICE MANUAL D/GB 6.ERGAENZUNG	SERVICE MANUAL D/GB 6TH SUPPLEMENT
		297040197800	X	CHASSIS-FS-STEREO DIGI 100 CUC 1838 KEIN E-TEIL	CHASSIS TV STEREO DIGI 100 CUC 1838 NO SPARE PART
				X = SIEHE GESONDERTE E-LISTE	X = SEE SEPARATE PARTS LIST
				ALLE ANDEREN TEILE SIEHE E-LISTE ELEGANCE 72 MF 72-3110/8 DOLBY MAT.-NR: 921993024000 BESTELL-NR: GCL8600 AUSGABE 8/2001 VERSION-NR.: VNM	FOR ALL OTHER PARTS SEE ELEGANCE 72 MF 72-3110/8 DOLBY PART NO: 921993024000 ORDER NO: GCL8600 EDITION 8/2001 VERSION NO.: VNM

88

ÄNDERUNGEN VORBEHALTEN / SUBJECT TO ALTERATION

POS. NR. MATERIAL-NR. BEZEICHNUNG  
POS. NO. PART NUMBER DESCRIPTION

POS. NR. MATERIAL-NR. BEZEICHNUNG  
POS. NO. PART NUMBER DESCRIPTION

### ELEGANCE 72 MF 72-3110/8 DOLBY

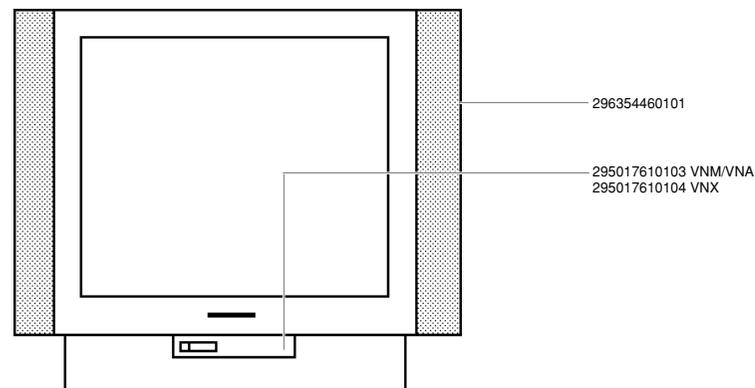

Es gelten die Vorschriften und Sicherheitshinweise gemäß dem Service Manual "Sicherheit", Mat.-Nummer 720108000000, sowie zusätzlich die eventuell abweichenden, landesspezifischen Vorschriften!



The regulations and safety instructions shall be valid as provided by the "Safety" Service Manual, part number 720108000000, as well as the respective national deviations.

ÄNDERUNGEN VORBEHALTEN / SUBJECT TO ALTERATION

# Ersatzteilliste Spare Parts List

## 7 / 2002

### LEEMAXX 72 FLAT MF 72-9110/8 DOLBY

MATERIAL-NR. / PART NO.: 922214023800 BESTELL-NR. / ORDER NO.: GCM9100 AQUA SILBER/AQUA SILVER  
VERSION NR./VERSION NO.: **VNA**

POS. NR. POS. NO.	ABB. FIG.	MATERIAL-NR. PART NUMBER	ANZ. QTY.	BEZEICHNUNG (D)	DESCRIPTION (GB)
		922214023800		LEEMAXX 72 FLAT MF 72-9110/8 DOLBY AQUA SILBER KEIN E-TEIL	LEEMAXX 72 FLAT MF 72-9110/8 DOLBY AQUA SILBER NO SPARE PART
0050.000				PROGRAMM FLASH-EPROM <b>DEUTSCHLAND</b> DOWNLOAD: HTTP://PARTNERWEB. GRUNDIG.DE/KUNDENDIENST	PROGRAM FLASH EPROM <b>GERMANY</b> DOWNLOAD: HTTP://PARTNERWEB. GRUNDIG.DE/KUNDENDIENST
0050.000				PROGRAMM FLASH-EPROM <b>INTERNATIONAL</b> DOWNLOAD: WWW.GRUNDIG.DE/ PRODUKTE/KONTAKT/HAENDLERSERVICE	PROGRAM FLASH EPROM <b>INTERNATIONAL</b> DOWNLOAD: WWW.GRUNDIG.DE/ PRODUCTS/CONTACT/RESELLER SUPPORT
0225.000		296366990102		KLAPPE BEDIENUNG	FLAP CONTROL
0240.000		293033904200		KOPFHÖRERBUCHSE 3,5 O.SCHALTER	HEADPHONE SOCKET 3,5 W/O SWITCH
0241.000		293031689401		CINCH-BUCHSE 3-FACH FBAS/NF L,R	CINCH SOCKET 3 FOLD FBAS/AF L,R
0320.000		291104906404		TYPENAUFKLEBER VNA	TYPE LABEL VNA
0950.000		292104087606		SHIFTSTECKER KPL 5 W/180 OHM	SHIFT PLUG CPL 5 W/180 OHM
0950.000		292104087306		SHIFTSTECKER KPL 4 W/330 OHM	SHIFT PLUG CPL 4 W/330 OHM
		222149410201		BEDIENUNGSANLEITUNG D	OPERATING INSTRUCTIONS D
		222149410301		BEDIENUNGSANLEITUNG F/I	OPERATING INSTRUCTIONS F/I
		222149410401		BEDIENUNGSANLEITUNG GB/NL	OPERATING INSTRUCTIONS GB/NL
		222149410501		BEDIENUNGSANLEITUNG E/P	OPERATING INSTRUCTIONS E/P
		222149410601		BEDIENUNGSANLEITUNG DK/FIN	OPERATING INSTRUCTIONS DK/FIN
		222149410701		BEDIENUNGSANLEITUNG S/N	OPERATING INSTRUCTIONS S/N
		720100305000		SERVICE MANUAL D/GB	SERVICE MANUAL D/GB
		720100305400		SERVICE MANUAL D/GB 4.ERGAENZUNG	SERVICE MANUAL D/GB 4TH SUPPLEMENT
		720100305500		SERVICE MANUAL D/GB 5.ERGAENZUNG	SERVICE MANUAL D/GB 5TH SUPPLEMENT
		720100305600		SERVICE MANUAL D/GB 6.ERGAENZUNG	SERVICE MANUAL D/GB 6TH SUPPLEMENT
		297040192100	X	CHASSIS-FS-STEREO CUC 1838 DIGI 100 KEIN E-TEIL	CHASSIS TV STEREO CUC 1838 DIGI 100 NO SPARE PART
				X-SIEHE GESONDERTE E-LISTE	X=SEE SEPARATE PARTS LIST
				ALLE WEITEREN TEILE SIEHE E-LISTE LEEMAXX 72 FLAT MF 72-9110/8 DOLBY AQUA SILBER MAT.-NR.: 922214023800 BESTELL-NR.: GCM9100 AUSGABE 9/2001 VERSION NR.: <b>VNM</b>	FOR ALL OTHER PARTS SEE LEEMAXX 72 FLAT MF 72-9110/8 DOLBY AQUA SILVER PART NO.: 922214023800 ORDER NR.: GCM9100 EDITION 9/2001 VERSION NO.: <b>VNM</b>

ÄNDERUNGEN VORBEHALTEN / SUBJECT TO ALTERATION

# GRUNDIG

## TV

POS. NR. MATERIAL-NR. BEZEICHNUNG  
POS. NO. PART NUMBER DESCRIPTION

POS. NR. MATERIAL-NR. BEZEICHNUNG  
POS. NO. PART NUMBER DESCRIPTION

### LEEMAXX 72 FLAT MF 72-9110/8 DOLBY

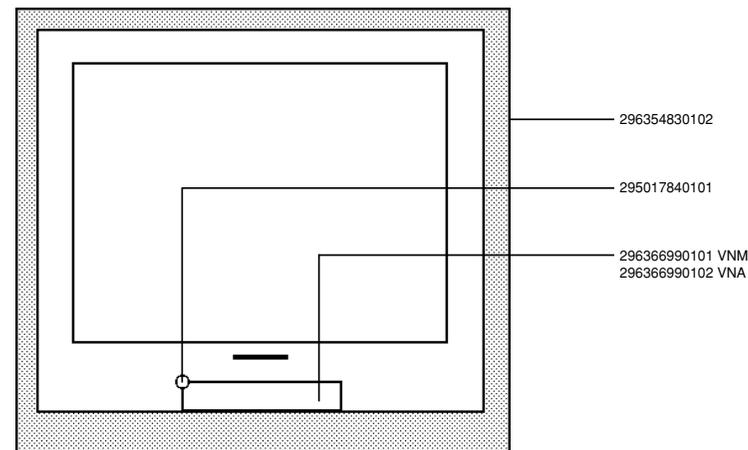

Es gelten die Vorschriften und Sicherheitshinweise gemäß dem Service Manual "Sicherheit", Mat.-Nummer 720108000000, sowie zusätzlich die eventuell abweichenden, landesspezifischen Vorschriften!



The regulations and safety instructions shall be valid as provided by the "Safety" Service Manual, part number 720108000000, as well as the respective national deviations.

ÄNDERUNGEN VORBEHALTEN / SUBJECT TO ALTERATION

## Ersatzteilliste Spare Parts List

### 7 / 2002

### LEEMAXX 72 FLAT MF 72-9110/8 DOLBY

MATERIAL-NR. / PART NO.: 922214023800 BESTELL-NR. / ORDER NO.: GCM9100 AQUA SILBER/AQUA SILVER  
VERSION NR./VERSION NO.: VNX

POS. NR. POS. NO.	ABB. FIG.	MATERIAL-NR. PART NUMBER	ANZ. QTY.	BEZEICHNUNG (D)	DESCRIPTION (GB)
		922214023800		LEEMAXX 72 FLAT MF 72-9110/8 DOLBY AQUA SILBER KEIN E-TEIL	LEEMAXX 72 FLAT MF 72-9110/8 DOLBY AQUA SILBER NO SPARE PART
0050.000				PROGRAMM FLASH-EPROM <b>DEUTSCHLAND</b> DOWNLOAD: HTTP://PARTNERWEB. GRUNDIG.DE/KUNDENDIENST	PROGRAM FLASH EPROM <b>GERMANY</b> DOWNLOAD: HTTP://PARTNERWEB. GRUNDIG.DE/KUNDENDIENST
0050.000				PROGRAMM FLASH-EPROM <b>INTERNATIONAL</b> DOWNLOAD: WWW.GRUNDIG.DE/ PRODUKTE/KONTAKT/HAENDLERSERVICE	PROGRAM FLASH EPROM <b>INTERNATIONAL</b> DOWNLOAD: WWW.GRUNDIG.DE/ PRODUCTS/CONTACT/RESELLER SUPPORT
0212.000		297006510104		ABDECKUNG DIGI-100	COVER DIGI-100
0225.000		296366990102		KLAPPE BEDIENUNG	FLAP CONTROL
0240.000		293033904200		KOPFHÖRERBUCHSE 3,5 O.SCHALTER	HEADPHONE SOCKET 3,5 W/O SWITCH
0241.000		293031689401		CINCH-BUCHSE 3-FACH FBAS/NF L,R	CINCH SOCKET 3 FOLD FBAS/AF L,R
0320.000		291104906504		TYPENAUFKLEBER VNX	TYPE LABEL VNX
0950.000		292104087606		SHIFTSTECKER KPL 5 W/180 OHM	SHIFT PLUG CPL 5 W/180 OHM
0950.000		292104087306		SHIFTSTECKER KPL 4 W/330 OHM	SHIFT PLUG CPL 4 W/330 OHM
1100.000	△	830006835700		BILDR.A68LTF356X96 TOSHIBA	PICT.TUBE A68LTF356X96 TOSHIBA
2300.000		293051223200	X	BILDROHRPLATTE	PICTURE TUBE BOARD
		222149410201		BEDIENUNGSANLEITUNG D	OPERATING INSTRUCTIONS D
		222149410301		BEDIENUNGSANLEITUNG F/I	OPERATING INSTRUCTIONS F/I
		222149410401		BEDIENUNGSANLEITUNG GB/NL	OPERATING INSTRUCTIONS GB/NL
		222149410501		BEDIENUNGSANLEITUNG E/P	OPERATING INSTRUCTIONS E/P
		222149410601		BEDIENUNGSANLEITUNG DK/FIN	OPERATING INSTRUCTIONS DK/FIN
		222149410701		BEDIENUNGSANLEITUNG S/N	OPERATING INSTRUCTIONS S/N
		720100305000		SERVICE MANUAL D/GB	SERVICE MANUAL D/GB
		720100305400		SERVICE MANUAL D/GB 4.ERGAENZUNG	SERVICE MANUAL D/GB 4TH SUPPLEMENT
		720100305500		SERVICE MANUAL D/GB 5.ERGAENZUNG	SERVICE MANUAL D/GB 5TH SUPPLEMENT
		720100305600		SERVICE MANUAL D/GB 6.ERGAENZUNG	SERVICE MANUAL D/GB 6TH SUPPLEMENT
		297040197200	X	CHASSIS-FS-STEREO CUC 1838 DIGI 100 KEIN E-TEIL	CHASSIS TV STEREO CUC 1838 DIGI 100 NO SPARE PART
				X=SIEMER GESONDERTE E-LISTE	X=SEE SEPARATE PARTS LIST
				ALLE WEITEREN TEILE SIEHE E-LISTE LEEMAXX 72 FLAT MF 72-9110/8 DOLBY AQUA SILBER MAT.-NR.: 922214023800 BESTELL-NR.: GCM9100 AUSGABE 9/2001 VERSION NR.: VNM	FOR ALL OTHER PARTS SEE LEEMAXX 72 FLAT MF 72-9110/8 DOLBY AQUA SILBER PART NO.: 922214023800 ORDER NR.: GCM9100 EDITION 9/2001 VERSION NO.: VNM

85

### LEEMAXX 72 FLAT MF 72-9110/8 DOLBY

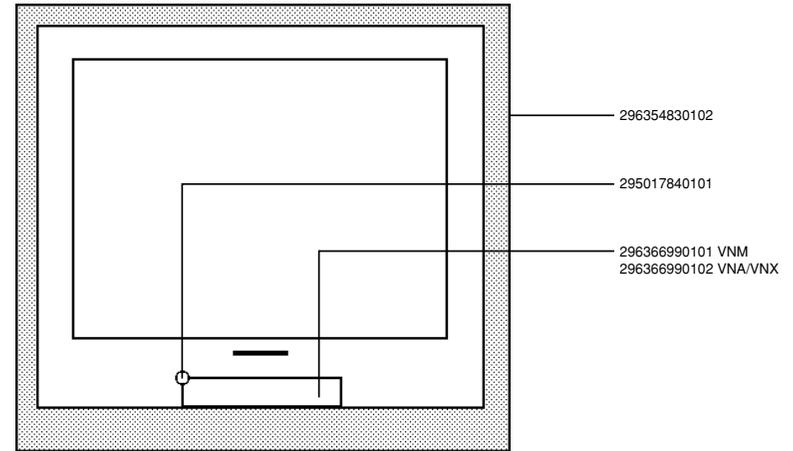

POS. NR. MATERIAL-NR. BEZEICHNUNG  
POS. NO. PART NUMBER DESCRIPTION

POS. NR. MATERIAL-NR. BEZEICHNUNG  
POS. NO. PART NUMBER DESCRIPTION

Es gelten die Vorschriften und Sicherheitshinweise gemäß dem Service Manual "Sicherheit", Mat.-Nummer 720108000000, sowie zusätzlich die eventuell abweichenden, landesspezifischen Vorschriften!



The regulations and safety instructions shall be valid as provided by the "Safety" Service Manual, part number 720108000000, as well as the respective national deviations.

ÄNDERUNGEN VORBEHALTEN / SUBJECT TO ALTERATION

ÄNDERUNGEN VORBEHALTEN / SUBJECT TO ALTERATION

MATERIAL-NR. / PART NO.: 922206016900 BESTELL-NR. / ORDER NO.: GCK6875 TESSA BLACK  
VERSION NR./VERSION NO.: **VNA**

POS. NR. POS. NO.	ABB. FIG.	MATERIAL-NR. PART NUMBER	ANZ. QTY.	BEZEICHNUNG <b>(D)</b>	DESCRIPTION <b>(GB)</b>
		922206016900		TORONTO SE 7216 DOLBY TESSA BLACK KEIN E-TEIL	TORONTO SE 7216 DOLBY TESSA BLACK NO SPARE PART
0050.000				PROGRAMM FLASH-EPROM <b>DEUTSCHLAND</b> DOWNLOAD: HTTP://PARTNERWEB. GRUNDIG.DE/KUNDENDIENST	PROGRAM FLASH EPROM <b>GERMANY</b> DOWNLOAD: HTTP://PARTNERWEB. GRUNDIG.DE/KUNDENDIENST
0050.000				PROGRAMM FLASH-EPROM <b>INTERNATIONAL</b> DOWNLOAD: WWW.GRUNDIG.DE/ PRODUKTE/KONTAKT/HAENDLERSERVICE	PROGRAM FLASH EPROM <b>INTERNATIONAL</b> DOWNLOAD: WWW.GRUNDIG.DE/ PRODUCTS/CONTACT/RESELLER SUPPORT
0201.000 0312.000 0320.000 0700.000 0950.000 0950.000 1100.000 1370.000 1395.000 2410.000	<b>△</b>	191260469701 297006510104 291105096401 092461347500 292104087306 292104087606 830006824300 295017210302 295017380303 720086734000	2	LAUTSPRECHER KOMBI ABDECKUNG DIGI-100 TYPENAUFKLEBER VNA SPULE ENTMAGNETISIERUNG SHIFTSTECKER KPL 4W/330 OHM SHIFTSTECKER KPL 5W/180 BILDROHR A 68 ESF002X43 PHILIPS TASTENKNOPF NETZ KPL AUFNAHME BEDIENPLATTE DRUCK KPL DECKEL BATTERIE	LOUDSPEAKER COMBI COVER DIGI-100 TYPE LABEL VNA DEGAUSSING COIL SHIFT PLUG CPL 4W/330 OHM OHM SHIFT PLUG CPL 5W/180 OHM PICTURE TUBE A 68 ESF002X43 PHILIPS KEY KNOB POWER CPL HOLDER CONTROL BOARD PRINT CPL BATTERY LID
		222069410100 720100305000 720100305400 720100305500 720100305600		BEDIENUNGSANLEITUNG D/I SERVICE MANUAL D/GB SERVICE MANUAL D/GB 4.ERGAENZUNG SERVICE MANUAL D/GB 5.ERGAENZUNG SERVICE MANUAL D/GB 6.ERGAENZUNG	OPERATION INSTRUCTIONS D/I SERVICE MANUAL D/GB SERVICE MANUAL D/GB 4TH SUPPLEMENT SERVICE MANUAL D/GB 5TH SUPPLEMENT SERVICE MANUAL D/GB 6TH SUPPLEMENT
		296560041600		MONTAGEZUBEHOER F.BILDROHR KEIN E-TEIL	MOUNTING ACCESSORIES F.PICT. TUBE NO SPARE PART
		297040194300	X	CHASSIS-FS-STEREO DIGI 100 CUC 1838 KEIN E-TEIL	CHASSIS TV STEREO DIGI 100 CUC 1838 NO SPARE PART
				X = SIEHE GESONDERTE E-LISTE	X = SEE SEPARATE PARTS LIST
				ALLE ANDEREN TEILE SIEHE E-LISTE TORONTO SE 7216 DOLBY MAT.-NR: 922206016900 BESTELL-NR: GCK6875 AUSGABE 1/2001 VERSION-NR.: <b>VNM</b>	FOR ALL OTHER PARTS SEE TORONTO SE 7216 DOLBY PART NO: 922206016900 ORDER NO: GCK6875 EDITION 1/2001 VERSION NO.: <b>VNM</b>

POS. NR. POS. NO.	MATERIAL-NR. PART NUMBER	BEZEICHNUNG DESCRIPTION	POS. NR. POS. NO.	MATERIAL-NR. PART NUMBER	BEZEICHNUNG DESCRIPTION
	295010853000	BEDIENEINHEIT M.AUFNAHME CONTROL UNIT W.HOLDER KEIN E-TEIL/NO SPARE PART			
D 85001	830998411900	LE-DIODE L-119EGW			

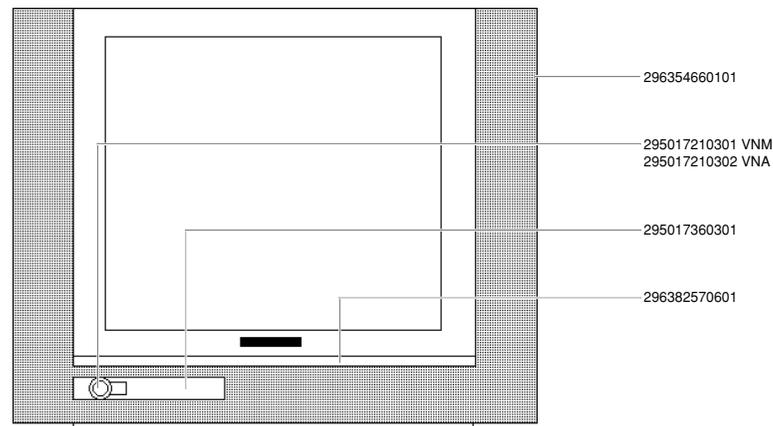

Es gelten die Vorschriften und Sicherheitshinweise gemäß dem Service Manual "Sicherheit", Mat.-Nummer 720108000000, sowie zusätzlich die eventuell abweichenden, landesspezifischen Vorschriften!



The regulations and safety instructions shall be valid as provided by the "Safety" Service Manual, part number 720108000000, as well as the respective national deviations.

### Ersatzteilliste Spare Parts List

7 / 2002

### TORONTO SE 7216/8 DOLBY

MATERIAL-NR. / PART NO.: 922206026900 BESTELL-NR. / ORDER NO.: GCK6775 TESSA BLACK/TESSA BLACK  
VERSION NR./VERSION NO.: VNA

POS. NR. POS. NO.	ABB. FIG.	MATERIAL-NR. PART NUMBER	ANZ. QTY.	BEZEICHNUNG (D)	DESCRIPTION (GB)
		922206026900		TORONTO SE 7216/8 DOLBY TESSA BLACK KEIN E-TEIL	TORONTO SE 7216/8 DOLBY TESSA BLACK NO SPARE PART
0050.000				PROGRAMM FLASH-EPROM <b>DEUTSCHLAND</b> DOWNLOAD: HTTP://PARTNERWEB. GRUNDIG.DE/KUNDENDIENST	PROGRAM FLASH EPROM <b>GERMANY</b> DOWNLOAD: HTTP://PARTNERWEB. GRUNDIG.DE/KUNDENDIENST
0050.000				PROGRAMM FLASH-EPROM <b>INTERNATIONAL</b> DOWNLOAD: WWW.GRUNDIG.DE/ PRODUKTE/KONTAKT/HAENDLERSERVICE	PROGRAM FLASH EPROM <b>INTERNATIONAL</b> DOWNLOAD: WWW.GRUNDIG.DE/ PRODUCTS/CONTACT/RESELLER SUPPORT
0201.000		191260469701	2	LAUTSPRECHER KOMBI	LOUDSPEAKER COMBI
0312.000		297006510104		ABDECKUNG DIGI-100	COVER DIGI-100
0320.000		291104306403		TYPENAUFKLEBER VNA	TYPE LABEL SELF ADHESIVE VNA
0700.000	△	092461347500		SPULE ENTMAGNETISIERUNG	DEGAUSSING COIL
0950.000		292104087306		SHIFTSTECKER KPL 4W/330 OHM	SHIFT PLUG CPL 4W/330 OHM
0950.000		292104087606		SHIFTSTECKER KPL 5W/180 OHM	SHIFT PLUG CPL 5W/180 OHM
1100.000		830006824300		BILDROHR A 68 ESF002X43 PHILIPS	PICTURE TUBE A 68 ESF002X43 PHILIPS
1370.000		295017210302		TASTENKNOPF NETZ KPL	KEY KNOB POWER CPL
2410.000		720086734000		DECKEL BATTERIE	BATTERY LID
		222069410200		BEDIENUNGSANLEITUNG GB/N	OPERATION INSTRUCTIONS GB/N
		720100305000		SERVICE MANUAL D/GB	SERVICE MANUAL D/GB
		720100305400		SERVICE MANUAL D/GB 4.ERGAENZUNG	SERVICE MANUAL D/GB 4TH SUPPLEMENT
		720100305500		SERVICE MANUAL D/GB 5.ERGAENZUNG	SERVICE MANUAL D/GB 5TH SUPPLEMENT
		720100305600		SERVICE MANUAL D/GB 6.ERGAENZUNG	SERVICE MANUAL D/GB 6TH SUPPLEMENT
		296560041600		MONTAGEZUBEHOER F.BILDROHR KEIN E-TEIL	MOUNTING ACCESSORIES F.PICT. TUBE NO SPARE PART
		297040194400	X	CHASSIS-FS-STEREO DIGI 100 CUC 1838 KEIN E-TEIL	CHASSIS TV STEREO DIGI 100 CUC 1838 NO SPARE PART
				X = SIEHE GESONDERTE E-LISTE	X = SEE SEPARATE PARTS LIST
				ALLE ANDEREN TEILE SIEHE E-LISTE TORONTO SE 7216/8 DOLBY MAT.-NR: 922206026900 BESTELL-NR: GCK6775 AUSGABE 1/2001 VERSION-NR: VNM	FOR ALL OTHER PARTS SEE TORONTO SE 7216/8 DOLBY PART NO: 922206026900 ORDER NO: GCK6775 EDITION 1/2001 VERSION NO: VNM

POS. NR. POS. NO.	MATERIAL-NR. PART NUMBER	BEZEICHNUNG DESCRIPTION
	295010853000	BEDIENEINHEIT M.AUFNAHME CONTROL UNIT W.HOLDER KEIN E-TEIL/NO SPARE PART
D 85001	830998411900	LE-DIODE L-119EGW

POS. NR. POS. NO.	MATERIAL-NR. PART NUMBER	BEZEICHNUNG DESCRIPTION
	296354660101	
	295017210301 VNM	295017210302 VNA
	295017360301	
	296382570601	

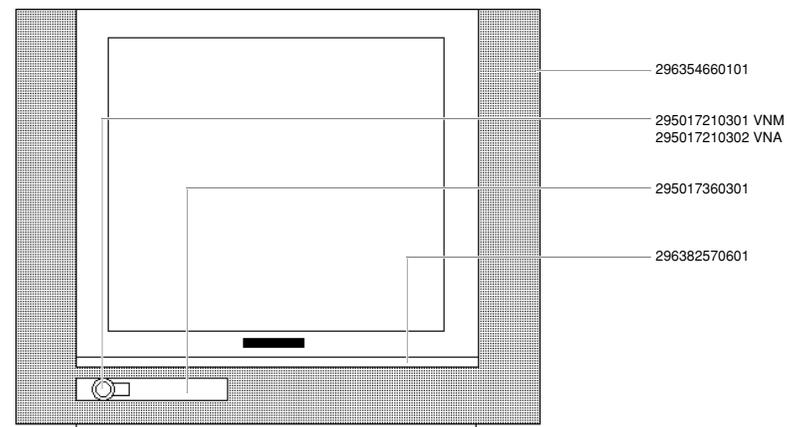

Es gelten die Vorschriften und Sicherheitshinweise gemäß dem Service Manual "Sicherheit", Mat.-Nummer 720108000000, sowie zusätzlich die eventuell abweichenden, landesspezifischen Vorschriften!



The regulations and safety instructions shall be valid as provided by the "Safety" Service Manual, part number 720108000000, as well as the respective national deviations.

MATERIAL-NR. / PART NO.: 922205017500 BESTELL-NR. / ORDER NO.: GCM5700 SCHWARZ/BLACK  
VERSION NR./VERSION NO.: VNA

POS. NR. POS. NO.	ABB. FIG.	MATERIAL-NR. PART NUMBER	ANZ. QTY.	BEZEICHNUNG ①	DESCRIPTION ②
		922205017500		SYDNEY SE 7240 DOLBY SCHWARZ KEIN E-TEIL	SYDNEY SE 7240 DOLBY BLACK NO SPARE PART
0050.000				PROGRAMM FLASH-EPROM <b>DEUTSCHLAND</b> DOWNLOAD: HTTP://PARTNERWEB. GRUNDIG.DE/KUNDENDIENST	PROGRAM FLASH EPROM <b>GERMANY</b> DOWNLOAD: HTTP://PARTNERWEB. GRUNDIG.DE/KUNDENDIENST
0050.000				PROGRAMM FLASH-EPROM <b>INTERNATIONAL</b> DOWNLOAD: WWW.GRUNDIG.DE/ PRODUKTE/KONTAKT/HAENDLERSERVICE	PROGRAM FLASH EPROM <b>INTERNATIONAL</b> DOWNLOAD: WWW.GRUNDIG.DE/ PRODUKTE/CONTACT/RESELLER SUPPORT
0201.000		191260469701	2	LAUTSPRECHER KOMBI 8 OHM	SPEAKER COMBI 8 OHM
0313.000		296364568703	4	ABDECKUNG SCHRAUBE GEH-RUECKTEIL	COVER SCREW CABINET REAR PART
0320.000		291105026401		TYPENAUFKLEBER VNA	TYPE LABEL VNA
0740.000		296073090101		HALTER SPULE ENTMAGNETISIERUNG	HOLDER DEGAUSSING COIL
0950.000		292104087606		SHIFTSTECKER KPL 5 W/180 OHM	SHIFT PLUG CPL 5 W/180 OHM
0950.000		292104087306		SHIFTSTECKER KPL 4 W/330 OHM	SHIFT PLUG CPL 4 W/330 OHM
1100.000		830006824300		BILDR.A68ESF002X43	PICT.TUBE A68ESF002X43
1352.000		295017740502		BEDIENTEIL M.KLAPPE MONTIERT	CONTROL UNIT W.FLAP MOUNTED
1353.000		270332210100		DRUCKSCHNAPPER	PRESSURE CATCH
1354.000		296380231101		DAEMPFBLOCK Klappe	DAMPING BLOCK FLAP
1900.000	△	295010870700		NETZSCHALTERPLATTE	POWER SWITCH BOARD
1900.000	△	295010871400		NETZSCHALTERPLATTE	POWER SWITCH BOARD
1960.000	△	297032917105		NETZSCHALTER ECO O.WISCHER	POWER SWITCH ECO W/O WIPER
1970.000		295017310102		TASTENKNOPF NETZ	KEY KNOB POWER
		222059410100		BEDIENUNGSANLEITUNG D/I	OPERATING INSTRUCTIONS D/I
		720100305000		SERVICE MANUAL D/GB	SERVICE MANUAL D/GB
		720100305400		SERVICE MANUAL D/GB 4.ERGAENZUNG	SERVICE MANUAL D/GB 4TH SUPPLEMENT
		720100305500		SERVICE MANUAL D/GB 5.ERGAENZUNG	SERVICE MANUAL D/GB 5TH SUPPLEMENT
		720100305600		SERVICE MANUAL D/GB 6.ERGAENZUNG	SERVICE MANUAL D/GB 6TH SUPPLEMENT
		297040194200	X	CHASSIS-FS-STEREO CUC 1838 DIGI 100 KEIN E-TEIL	CHASSIS TV STEREO CUC 1838 DIGI 100 NO SPARE PART
				X=SIEHE GESONDERTE E-LISTE	X=SEE SEPARATE PARTS LIST
				ALLE WEITEREN TEILE SIEHE E-LISTE SYDNEY SE 7240 DOLBY SCHWARZ MAT.-NR.: 922205017500 BESTELL-NR.: GCM5700 AUSGABE 2/2001 VERSION NR.: VNM	FOR ALL OTHER PARTS SEE SYDNEY SE 7240 DOLBY BLACK PART NO: 922205017500 ORDER NR: GCM5700 EDITION 2/2001 VERSION NO.: VNM

POS. NR. POS. NO.	MATERIAL-NR. PART NUMBER	BEZEICHNUNG DESCRIPTION	POS. NR. POS. NO.	MATERIAL-NR. PART NUMBER	BEZEICHNUNG DESCRIPTION
	295010870700	NETZSCHALTERPLATTE POWER SWITCH BOARD			
L 62001	△ 295008410400	ENTSTOER-DR 2X1MH			
	295010871400	NETZSCHALTERPLATTE POWER SWITCH BOARD			
CD 81001	833050414800	MELF DIODE MCL4148			
CT 81001	830119005000	SMD TRANS BSP50			
CT 81002	830100484800	SMD TRANS BC848B/ BC847B			
D 85001	830998411600	LE-DIODE L-115WEGW			

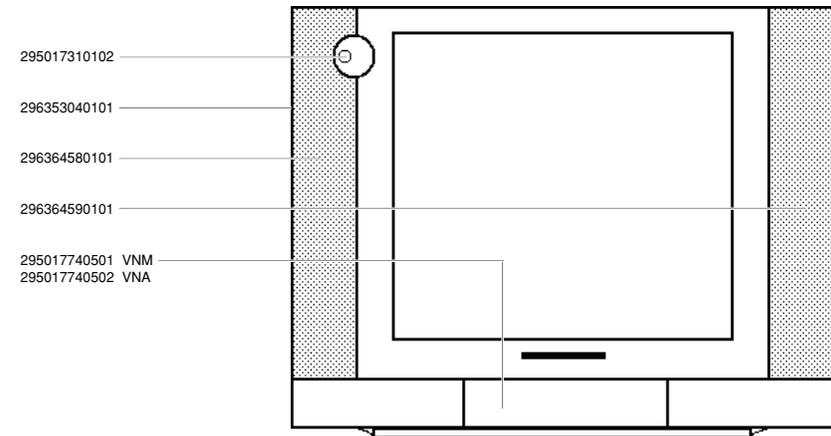

# Ersatzteilliste Spare Parts List

## 7 / 2002

# GRUNDIG

# TV

## SYDNEY SE 7240 DOLBY

MATERIAL-NR. / PART NO.: 922205019200 BESTELL-NR. / ORDER NO.: GCM5710 TITANE  
VERSION NR./VERSION NO.: VNA

POS. NR. POS. NO.	ABB. FIG.	MATERIAL-NR. PART NUMBER	ANZ. QTY.	BEZEICHNUNG (D)	DESCRIPTION (GB)
		922205019200		SYDNEY SE 7240 DOLBY TITANE KEIN E-TEIL	SYDNEY SE 7240 DOLBY TITANE NO SPARE PART
0050.000				PROGRAMM FLASH-EPROM <b>DEUTSCHLAND</b> DOWNLOAD: HTTP://PARTNERWEB. GRUNDIG.DE/KUNDENDIENST	PROGRAM FLASH EPROM <b>GERMANY</b> DOWNLOAD: HTTP://PARTNERWEB. GRUNDIG.DE/KUNDENDIENST
0050.000				PROGRAMM FLASH-EPROM <b>INTERNATIONAL</b> DOWNLOAD: WWW.GRUNDIG.DE/ PRODUKTE/KONTAKT/HAENDLERSERVICE	PROGRAM FLASH EPROM <b>INTERNATIONAL</b> DOWNLOAD: WWW.GRUNDIG.DE/ PRODUCTS/CONTACT/RESELLER SUPPORT
0201.000		191260469701	2	LAUTSPRECHER KOMBI 8 OHM	SPEAKER COMBI 8 OHM
0300.000		296364000202		GEH-RUECKTEIL OFB	CABINET REAR PART SURFACE TREATED
0313.000		296364560204	4	ABDECKUNG SCHRAUBE GEH-RUECKTEIL	COVER SCREW CABINET REAR PART
0320.000		291105026401		TYPENAUFKLEBER VNA	TYPE LABEL VNA
0740.000		296073090101		HALTER SPULE ENTMAGNETISIERUNG	HOLDER DEGAUSSING COIL
0950.000		292104087606		SHIFTSTECKER KPL 5 W/180 OHM	SHIFT PLUG CPL 5 W/180 OHM
0950.000		292104087306		SHIFTSTECKER KPL 4 W/330 OHM	SHIFT PLUG CPL 4 W/330 OHM
1100.000		830006824300		BILDR.A68ESF002X43	PICT.TUBE A68ESF002X43
1352.000		295017740602		BEDIENTEIL M.KLAPPE MONTIERT	CONTROL UNIT W.FLAP MOUNTED
1353.000		270332210100		DRUCKSCHNAPPER	PRESSURE CATCH
1354.000		296380231101		DAEMPFUNGSBLOCK KLAPPE	DAMPING BLOCK FLAP
2100.000	△	829099131600		NETZKABEL KPL	POWER CABLE CPL
		222059410100		BEDIENUNGSANLEITUNG D/I	OPERATING INSTRUCTIONS D/I
		720100305000		SERVICE MANUAL D/GB	SERVICE MANUAL D/GB
		720100305400		SERVICE MANUAL D/GB 4.ERGAENZUNG	SERVICE MANUAL D/GB 4TH SUPPLEMENT
		720100305500		SERVICE MANUAL D/GB 5.ERGAENZUNG	SERVICE MANUAL D/GB 5TH SUPPLEMENT
		720100305600		SERVICE MANUAL D/GB 6.ERGAENZUNG	SERVICE MANUAL D/GB 6TH SUPPLEMENT
		297040194200	X	CHASSIS-FS-STEREO CUC 1838 DIGI 100 KEIN E-TEIL	CHASSIS TV STEREO CUC 1838 DIGI 100 NO SPARE PART
				X-SIEHE GESONDERTE E-LISTE	X-SEE SEPARATE PARTS LIST
				ALLE WEITEREN TEILE SIEHE E-LISTE SYDNEY SE 7240 DOLBY TITANE MAT.-NR.: 922205019200 BESTELL-NR.: GCM5710 AUSGABE 2/2001 VERSION NR.: VNM	FOR ALL OTHER PARTS SEE SYDNEY SE 7240 DOLBY TITANE PART NO.: 922205019200 ORDER NR.: GCM5710 EDITION 2/2001 VERSION NO.: VNM

POS. NR. POS. NO.	MATERIAL-NR. PART NUMBER	BEZEICHNUNG DESCRIPTION	POS. NR. POS. NO.	MATERIAL-NR. PART NUMBER	BEZEICHNUNG DESCRIPTION
	295010871200	NETZSCHALTERPLATTE POWER SWITCH BOARD			
L 62001	△	295008410400		ENTSTOER-DR 2X1MH	

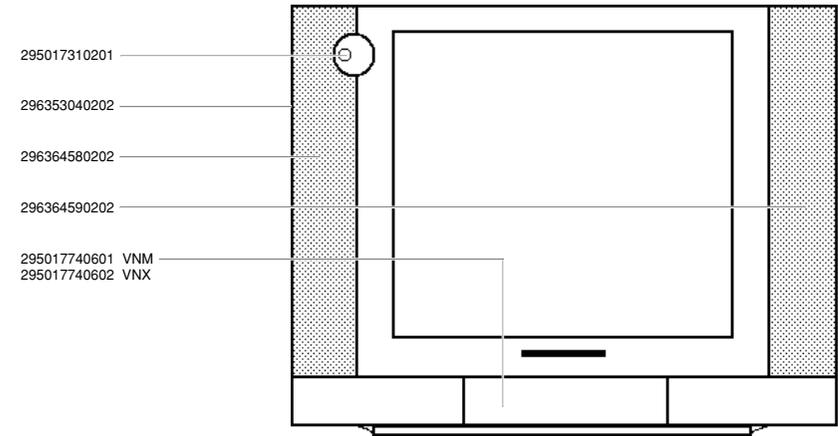

68

ÄNDERUNGEN VORBEHALTEN / SUBJECT TO ALTERATION

Es gelten die Vorschriften und Sicherheitshinweise gemäß dem Service Manual "Sicherheit", Mat.-Nummer 720108000000, sowie zusätzlich die eventuell abweichenden, landesspezifischen Vorschriften!



The regulations and safety instructions shall be valid as provided by the "Safety" Service Manual, part number 720108000000, as well as the respective national deviations.

ÄNDERUNGEN VORBEHALTEN / SUBJECT TO ALTERATION

## ATLANTA FLAT SE 7260 DOLBY

MATERIAL-NR. / PART NO.: 921941019200 BESTELL-NR. / ORDER NO.: GCK6475 TITAN/TITANE  
VERSION NR./VERSION NO.: VNX

POS. NR. POS. NO.	ABB. FIG.	MATERIAL-NR. PART NUMBER	ANZ. QTY.	BEZEICHNUNG ①	DESCRIPTION ②
		921941019200		ATLANTA FLAT SE 7260 DOLBY TITAN KEIN E-TEIL	ATLANTA FLAT SE 7260 DOLBY TITANE NO SPARE PART
0050.000				PROGRAMM FLASH-EPROM <b>DEUTSCHLAND</b> DOWNLOAD: HTTP://PARTNERWEB. GRUNDIG.DE/KUNDENDIENST	PROGRAM FLASH EPROM <b>GERMANY</b> DOWNLOAD: HTTP://PARTNERWEB. GRUNDIG.DE/KUNDENDIENST
0050.000				PROGRAMM FLASH-EPROM <b>INTERNATIONAL</b> DOWNLOAD: WWW.GRUNDIG.DE/ PRODUKTE/KONTAKT/HAENDLERSERVICE	PROGRAM FLASH EPROM <b>INTERNATIONAL</b> DOWNLOAD: WWW.GRUNDIG.DE/ PRODUCTS/CONTACT/RESELLER SUPPORT
0201.000		191260469701	2	LAUTSPRECHER KOMBI 8 OHM	SPEAKER COMBI 8 OHM
0300.000		296364000202		GEH-RUECKTEIL OFB	CABINET REAR PART SURFACE TREATED
0312.000		297006510401		ABDECKUNG DIGI-100	COVER DIGI-100
0313.000		296364560204	4	ABDECKUNG SCHRAUBE GEH-RUECKTEIL	COVER SCREW CABINET REAR PART
0320.000		291105116501		TYPENAUFKLEBER VNX	TYPE LABEL VNX
0700.000		092461357806		ENTMAGNETISIERUNGSSPULE KPL	DEGAUSSING COIL CPL
0740.000		296073090101		SPULENHALTER ENTMAGNETISIERUNGSSP.	HOLDER DEGAUSSING COIL
0900.000	△	292014800101		FOKUS/UG2-REGLER M.STECKER	FOCUS/UG2-CONTROLLER W.PLUG
0940.000		297006542101		HALTER FOKUSBLOCK	HOLDER FOCUS UNIT
0950.000		292104087606		SHIFTSTECKER KPL 5 W/180 OHM	SHIFT PLUG CPL 5 W/180 OHM
0950.000		292104087306		SHIFTSTECKER KPL 4 W/330 OHM	SHIFT PLUG CPL 4 W/330 OHM
1100.000	△	830006835700		BILDR.A68LTF356X96 <b>TOSHIBA</b>	PICT.TUBE A68LTF356X96 <b>TOSHIBA</b>
1100.000	△	830006889100		BILDR.A68QCP891X539 <b>SAMSUNG</b>	PICT.TUBE A68QCP891X539 <b>SAMSUNG</b>
1352.000		295017740702		BEDIENTEIL M.KLAPPE MONTIERT	CONTROL UNIT W.FLAP MOUNTED
1900.000	△	295010871300		NETZSCHALTERPLATTE	POWER SWITCH BOARD
1960.000	△	297032917105		NETZSCHALTER ECO O.WISCHER	POWER SWITCH ECO W/O WIPER
1970.000		295017310201		NETZTASTENKNOPF CHROM.M.LICHTLEITER	KNOB POWER KEY CHROMIUM
2300.000		293051223200	X	BILDROHRPLATTE <b>TOSHIBA-BR</b>	PICT.TUBE BOARD <b>TOSHIBA PT</b>
2300.000		293051224300	X	BILDROHRPLATTE <b>SAMSUNG-BR</b>	PICT.TUBE BOARD <b>SAMSUNG PT</b>
		219419410200		BEDIENUNGSANLEITUNG D	OPERATING INSTRUCTIONS D
		219419410300		BEDIENUNGSANLEITUNG GB/I	OPERATING INSTRUCTIONS GB/I
		720100305000		SERVICE MANUAL D/GB	SERVICE MANUAL D/GB
		720100305400		SERVICE MANUAL D/GB 4.ERGAENZUNG	SERVICE MANUAL D/GB 4TH SUPPLEMENT
		720100305500		SERVICE MANUAL D/GB 5.ERGAENZUNG	SERVICE MANUAL D/GB 5TH SUPPLEMENT
		720100305600		SERVICE MANUAL D/GB 6.ERGAENZUNG	SERVICE MANUAL D/GB 6TH SUPPLEMENT
		296560044700		MONTAGEZUBEHOER F.BILDROHR KEIN E-TEIL	MOUNTING ACCESSORIES F.PT NO SPARE PART
		297040112200	X	CHASSIS-FS-STEREO <b>TOSHIBA-BR</b> CUC 1838 DIGI 100 KEIN E-TEIL	CHASSIS TV STEREO <b>TOSHIBA PT</b> CUC 1838 DIGI 100 NO SPARE PART
		297040116700	X	CHASSIS-FS-STEREO <b>SAMSUNG-BR</b> CUC 1838 DIGI 100 KEIN E-TEIL	CHASSIS TV STEREO <b>SAMSUNG PT</b> CUC 1838 DIGI 100 NO SPARE PART
				X-SIEHE GESONDERTE E-LISTE	X=SEE SEPARATE PARTS LIST

ÄNDERUNGEN VORBEHALTEN / SUBJECT TO ALTERATION

POS. NR. POS. NO.	ABB. FIG.	MATERIAL-NR. PART NUMBER	ANZ. QTY.	BEZEICHNUNG ①	DESCRIPTION ②
----------------------	--------------	-----------------------------	--------------	------------------	------------------

ALLE WEITEREN TEILE SIEHE E-LISTE  
ATLANTA FLAT SE 7260 DOLBY TITAN  
MAT.-NR.: 921941019200  
BESTELL-NR.: GCK6475  
AUSGABE 3/2001  
VERSION NR.: VNM

FOR ALL OTHER PARTS SEE  
ATLANTA FLAT SE 7260 DOLBY TITANE  
PART NO.: 921941019200  
ORDER NR.: GCK6475  
EDITION 3/2001  
VERSION NO.: VNM

POS. NR. POS. NO.	MATERIAL-NR. PART NUMBER	BEZEICHNUNG DESCRIPTION	POS. NR. POS. NO.	MATERIAL-NR. PART NUMBER	BEZEICHNUNG DESCRIPTION
----------------------	-----------------------------	----------------------------	----------------------	-----------------------------	----------------------------

295010871300 NETZSCHALTERPLATTE  
POWER SWITCH BOARD

CD 81001 833050414800 MELF DIODE MCL4148

CT 81001 830119005000 SMD TRANS BSP50

CT 81002 830100484800 SMD TRANS BC848B/ BC847B

D 85001 830998411600 LE-DIODE L-115WEGW

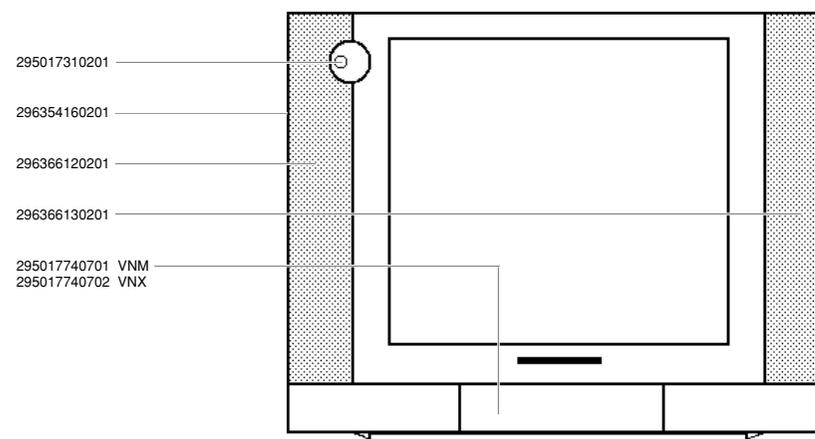

Es gelten die Vorschriften und Sicherheitshinweise gemäß dem Service Manual "Sicherheit", Mat.-Nummer 720108000000, sowie zusätzlich die eventuell abweichenden, landesspezifischen Vorschriften!



The regulations and safety instructions shall be valid as provided by the "Safety" Service Manual, part number 720108000000, as well as the respective national deviations.

ÄNDERUNGEN VORBEHALTEN / SUBJECT TO ALTERATION

MATERIAL-NR. / PART NO.: 921941019200 BESTELL-NR. / ORDER NO.: GCK6475 TITAN/TITANE  
VERSION NR./VERSION NO.: **VNG**

POS. NR. POS. NO.	ABB. FIG.	MATERIAL-NR. PART NUMBER	ANZ. QTY.	BEZEICHNUNG <b>(D)</b>	DESCRIPTION <b>(GB)</b>
		921941019200		ATLANTA FLAT SE 7260 DOLBY TITAN KEIN E-TEIL	ATLANTA FLAT SE 7260 DOLBY TITANE NO SPARE PART
0050.000				PROGRAMM FLASH-EPROM <b>DEUTSCHLAND</b> DOWNLOAD: HTTP://PARTNERWEB. GRUNDIG.DE/KUNDENDIENST	PROGRAM FLASH EPROM <b>GERMANY</b> DOWNLOAD: HTTP://PARTNERWEB. GRUNDIG.DE/KUNDENDIENST
0050.000				PROGRAMM FLASH-EPROM <b>INTERNATIONAL</b> DOWNLOAD: WWW.GRUNDIG.DE/ PRODUKTE/KONTAKT/HAENDLERSERVICE	PROGRAM FLASH EPROM <b>INTERNATIONAL</b> DOWNLOAD: WWW.GRUNDIG.DE/ PRODUCTS/CONTACT/RESELLER SUPPORT
0201.000		191260469701	2	LAUTSPRECHER KOMBI 8 OHM	SPEAKER COMBI 8 OHM
0300.000		296364000202		GEH-RUECKTEIL OFB	CABINET REAR PART SURFACE TREATED
0312.000		297006510401		ABDECKUNG DIGI-100	COVER DIGI-100
0313.000		296364560204	4	ABDECKUNG SCHRAUBE GEH-RUECKTEIL	COVER SCREW CABINET REAR PART
0320.000		291105116601		TYPENAUFKLEBER VNG	TYPE LABEL VNG
0700.000	△	092461567501		ENTMAGNETISIERUNGSSPULE M.HALT. KPL	DEGAUSSING COIL W.HOLDER CPL
0740.000		296073090101		SPULENHALTER ENTMAGNETISIERUNGSSP.	HOLDER DEGAUSSING COIL
0950.000		292104087606		SHIFTSTECKER KPL 5 W/180 OHM	SHIFT PLUG CPL 5 W/180 OHM
0950.000		292104087306		SHIFTSTECKER KPL 4 W/330 OHM	SHIFT PLUG CPL 4 W/330 OHM
1352.000		295017740702		BEDIENENTEIL M.KLAPPE MONTIERT	CONTROL UNIT W.FLAP MOUNTED
		219419410200		BEDIENUNGSANLEITUNG D	OPERATING INSTRUCTIONS D
		219419410300		BEDIENUNGSANLEITUNG GB/I	OPERATING INSTRUCTIONS GB/I
		720100305000		SERVICE MANUAL D/GB	SERVICE MANUAL D/GB
		720100305400		SERVICE MANUAL D/GB 4.ERGAENZUNG	SERVICE MANUAL D/GB 4TH SUPPLEMENT
		720100305500		SERVICE MANUAL D/GB 5.ERGAENZUNG	SERVICE MANUAL D/GB 5TH SUPPLEMENT
		720100305600		SERVICE MANUAL D/GB 6.ERGAENZUNG	SERVICE MANUAL D/GB 6TH SUPPLEMENT
		296560044701		MONTAGEZUBEHOER F.BILDROHR KEIN E-TEIL	MOUNTING ACCESSORIES F.PT NO SPARE PART
		297040190500	X	CHASSIS-FS-STEREO TOSHIBA-BR CUC 1838 DIGI 100 KEIN E-TEIL	CHASSIS TV STEREO TOSHIBA PT CUC 1838 DIGI 100 NO SPARE PART
				X=SIEHE GESONDERTE E-LISTE	X=SEE SEPARATE PARTS LIST
				ALLE WEITEREN TEILE SIEHE E-LISTE ATLANTA FLAT SE 7260 DOLBY TITAN MAT.-NR.: 921941019200 BESTELL-NR.: GCK6475 AUSGABE 3/2001 VERSION NR.: <b>VNM</b>	FOR ALL OTHER PARTS SEE ATLANTA FLAT SE 7260 DOLBY TITANE PART NO.: 921941019200 ORDER NR: GCK6475 EDITION 3/2001 VERSION NO.: <b>VNM</b>

POS. NR. POS. NO.	MATERIAL-NR. PART NUMBER	BEZEICHNUNG DESCRIPTION
		295010871200NETZSCHALTERPLATTE POWER SWITCH BOARD
L 62001	△	295008410400ENTSTOER-DR 2X1MH

POS. NR. POS. NO.	MATERIAL-NR. PART NUMBER	BEZEICHNUNG DESCRIPTION
		295017310201
		296354160201
		296366120201
		296366130201
		295017740701 VNM
		295017740702 VNX/VNG

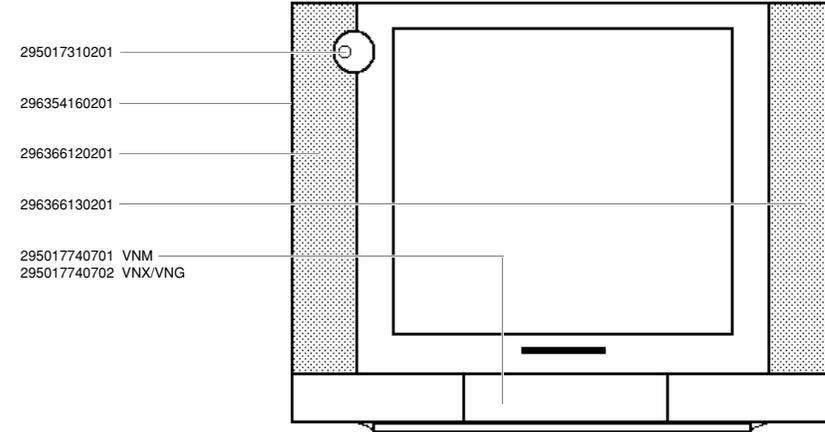

Es gelten die Vorschriften und Sicherheitshinweise gemäß dem Service Manual "Sicherheit", Mat.-Nummer 720108000000, sowie zusätzlich die eventuell abweichenden, landesspezifischen Vorschriften!



The regulations and safety instructions shall be valid as provided by the "Safety" Service Manual, part number 720108000000, as well as the respective national deviations.

## Ersatzteilliste Spare Parts List

### 7 / 2002

### ORLANDO FLAT SE 7270 DOLBY

MATERIAL-NR. / PART NO.: 922253012600 BESTELL-NR. / ORDER NO.: GCN6300 CLASSIC GRAU/CLASSIC GREY  
VERSION NR./VERSION NO.: **VNX**

POS. NR. POS. NO.	ABB. FIG.	MATERIAL-NR. PART NUMBER	ANZ. QTY.	BEZEICHNUNG (D)	DESCRIPTION (GB)
		922253012600		ORLANDO FLAT SE 7270 DOLBY CLASSIC GRAU KEIN E-TEIL	ORLANDO FLAT SE 7270 DOLBY CLASSIC GREY NO SPARE PART
0050.000				PROGRAMM FLASH-EPROM <b>DEUTSCHLAND</b> DOWNLOAD: HTTP://PARTNERWEB. GRUNDIG.DE/KUNDENDIENST PROGRAMM FLASH-EPROM <b>INTERNATIONAL</b> DOWNLOAD: WWW.GRUNDIG.DE/ PRODUKTE/KONTAKT/HAENDLERSERVICE	PROGRAM FLASH EPROM <b>GERMANY</b> DOWNLOAD: HTTP://PARTNERWEB. GRUNDIG.DE/KUNDENDIENST PROGRAM FLASH EPROM <b>INTERNATIONAL</b> DOWNLOAD: WWW.GRUNDIG.DE/ PRODUCTS/CONTACT/RESELLER SUPPORT
0201.000 0320.000 0950.000 0950.000 1100.000 1100.000		191260469701 291104846504 292104087606 292104087306 830006889100 830006835700	2	LAUTSPRECHER KOMBI 8 OHM TYPENAUFKLEBER VNX SHIFTSTECKER KPL 5 W/180 OHM SHIFTSTECKER KPL 4 W/330 OHM BILDR.A68QCP891X539 <b>SAMSUNG</b> BILDR.A68LTF356X96 <b>TOSHIBA</b>	SPEAKER COMBI 8 OHM TYPE LABEL VNX SHIFT PLUG CPL 5 W/180 OHM SHIFT PLUG CPL 4 W/330 OHM PICT.TUBE A68QCP891X539 <b>SAMSUNG</b> PICT.TUBE A68LTF356X96 <b>TOSHIBA</b>
1300.000		295010855100		BEDIENPLATTE M.DISPLAY KEIN E-TEIL	CONTROL BOARD W.DISPLAY NO SPARE PART
1301.000 1351.000		295017970102 295018040104		BEDIENEINSATZ FENSTEREINHEIT DRUCK KPL	CONTROL INSERT WINDOW UNIT PRINT CPL
2300.000 2300.000 2410.000		293051223200 293051224300 720086734000	X X	BILDROHRPLATTE <b>TOSHIBA-BR</b> BILDROHRPLATTE <b>SAMSUNG-BR</b> DECKEL BATTERIE TP 912 C	PICT.TUBE BOARD <b>TOSHIBA PT</b> PICT.TUBE BOARD <b>SAMSUNG PT</b> BATTERY LID TP 912 C
		222539410200 222539410300 720100305000 720100305400 720100305500 720100305600		BEDIENUNGSANLEITUNG D BEDIENUNGSANLEITUNG I/F SERVICE MANUAL D/GB SERVICE MANUAL D/GB 4.ERGAENZUNG SERVICE MANUAL D/GB 5.ERGAENZUNG SERVICE MANUAL D/GB 6.ERGAENZUNG	OPERATING INSTRUCTIONS D OPERATING INSTRUCTIONS I/F SERVICE MANUAL D/GB SERVICE MANUAL D/GB 4TH SUPPLEMENT SERVICE MANUAL D/GB 5TH SUPPLEMENT SERVICE MANUAL D/GB 6TH SUPPLEMENT
		297040114700	X	CHASSIS-FS-STEREO <b>SAMSUNG-BR</b> CUC 1838 DIGI 100 KEIN E-TEIL	CHASSIS TV STEREO <b>SAMSUNG PT</b> CUC 1838 DIGI 100 NO SPARE PART
		297040116600	X	CHASSIS-FS-STEREO <b>TOSHIBA-BR</b> CUC 1838 DIGI 100 KEIN E-TEIL	CHASSIS TV STEREO <b>TOSHIBA PT</b> CUC 1838 DIGI 100 NO SPARE PART
				X=SIEHES GESONDERTE E-LISTE	X=SEE SEPARATE PARTS LIST
				ALLE WEITEREN TEILE SIEHE E-LISTE ORLANDO FLAT SE 7270 DOLBY CLASSIC GRAU MAT.-NR.: 922253012600 BESTELL-NR.: GCN6300 AUSGABE 9/2001 VERSION NR.: <b>VNM</b>	FOR ALL OTHER PARTS SEE ORLANDO FLAT SE 7270 DOLBY CLASSIC GREY PART NO.: 922253012600 ORDER NR.: GCN6300 EDITION 9/2001 VERSION NO.: <b>VNM</b>

ÄNDERUNGEN VORBEHALTEN / SUBJECT TO ALTERATION

POS. NR. POS. NO.	MATERIAL-NR. PART NUMBER	BEZEICHNUNG DESCRIPTION	POS. NR. POS. NO.	MATERIAL-NR. PART NUMBER	BEZEICHNUNG DESCRIPTION
	295010855100	BEDIENPLATTE M.DISPLAY CONTROL BOARD W.DISPLAY			
CT 86016	830100680800	SMD TRANS BC808-40/ BC807-40			

Es gelten die Vorschriften und Sicherheitshinweise gemäß dem Service Manual "Sicherheit", Mat.-Nummer 720108000000, sowie zusätzlich die eventuell abweichenden, landesspezifischen Vorschriften!



The regulations and safety instructions shall be valid as provided by the "Safety" Service Manual, part number 720108000000, as well as the respective national deviations.

ÄNDERUNGEN VORBEHALTEN / SUBJECT TO ALTERATION

## Ersatzteilliste Spare Parts List

### 8 / 2002

### ORLANDO FLAT SE 7270 DOLBY

MATERIAL-NR. / PART NO.: 922253012600 BESTELL-NR. / ORDER NO.: GCN6300 CLASSIC GRAU/CLASSIC GREY  
VERSION NR./VERSION NO.: VNG

POS. NR. POS. NO.	ABB. FIG.	MATERIAL-NR. PART NUMBER	ANZ. QTY.	BEZEICHNUNG (D)	DESCRIPTION (GB)
		922253012600		ORLANDO FLAT SE 7270 DOLBY CLASSIC GRAU KEIN E-TEIL	ORLANDO FLAT SE 7270 DOLBY CLASSIC GREY NO SPARE PART
0050.000				PROGRAMM FLASH-EPROM <b>DEUTSCHLAND</b> DOWNLOAD: HTTP://PARTNERWEB. GRUNDIG.DE/KUNDENDIENST	PROGRAM FLASH EPROM <b>GERMANY</b> DOWNLOAD: HTTP://PARTNERWEB. GRUNDIG.DE/KUNDENDIENST
0050.000				PROGRAMM FLASH-EPROM <b>INTERNATIONAL</b> DOWNLOAD: WWW.GRUNDIG.DE/ PRODUKTE/KONTAKT/HAENDLERSERVICE	PROGRAM FLASH EPROM <b>INTERNATIONAL</b> DOWNLOAD: WWW.GRUNDIG.DE/ PRODUCTS/CONTACT/RESELLER SUPPORT
0201.000 0320.000 0740.000 0950.000 0950.000 1100.000		191260469701 291104846604 296073090101 292104087606 292104087306 830006835700	2	LAUTSPRECHER KOMBI 8 OHM TYPENAUFKLEBER VNG SPULENHALTER ENTMAGNETISIERUNGSSP. SHIFTSTECKER KPL 5 W/180 OHM SHIFTSTECKER KPL 4 W/330 OHM BILDR.A68LTF356X96 TOSHIBA	SPEAKER COMBI 8 OHM TYPE LABEL VNG HOLDER DEGAUSSING COIL SHIFT PLUG CPL 5 W/180 OHM SHIFT PLUG CPL 4 W/330 OHM PICT.TUBE A68LTF356X96 TOSHIBA
1300.000		295010855100		BEDIENPLATTE M.DISPLAY KEIN E-TEIL	CONTROL BOARD W.DISPLAY NO SPARE PART
1301.000 1351.000		295017970102 295018040104		BEDIENEINSATZ FENSTEREINHEIT DRUCK KPL	CONTROL INSERT WINDOW UNIT PRINT CPL
2300.000 2410.000		293051223200 720086734000	X	BILDROHRPLATTE DIGI 100 DECKEL BATTERIE TP 912 C	PICTURE TUBE BOARD DIGI 100 BATTERY LID TP 912 C
		222539410200 222539410300 720100305000 720100305400 720100305500 720100305600		BEDIENUNGSANLEITUNG D BEDIENUNGSANLEITUNG I/F SERVICE MANUAL D/GB SERVICE MANUAL D/GB 4.ERGAENZUNG SERVICE MANUAL D/GB 5.ERGAENZUNG SERVICE MANUAL D/GB 6.ERGAENZUNG	OPERATING INSTRUCTIONS D OPERATING INSTRUCTIONS I/F SERVICE MANUAL D/GB SERVICE MANUAL D/GB 4TH SUPPLEMENT SERVICE MANUAL D/GB 5TH SUPPLEMENT SERVICE MANUAL D/GB 6TH SUPPLEMENT
		296560044701		MONTAGEZUBEHOER F.BILDROHR KEIN E-TEIL	MOUNTING ACCESSORIES F.PT NO SPARE PART
		297040196000	X	CHASSIS-FS-STEREO CUC 1838 DIGI 100 KEIN E-TEIL	CHASSIS TV STEREO CUC 1838 DIGI 100 NO SPARE PART
				X=SIEHE GESONDERTE E-LISTE	X=SEE SEPARATE PARTS LIST
				ALLE WEITEREN TEILE SIEHE E-LISTE ORLANDO FLAT SE 7270 DOLBY CLASSIC GRAU MAT.-NR.: 922253012600 BESTELL-NR.: GCN6300 AUSGABE 9/2001 VERSION NR.: VNM	FOR ALL OTHER PARTS SEE ORLANDO FLAT SE 7270 DOLBY CLASSIC GREY PART NO: 922253012600 ORDER NR: GCN6300 EDITION 9/2001 VERSION NO.: VNM

ÄNDERUNGEN VORBEHALTEN / SUBJECT TO ALTERATION

POS. NR. POS. NO.	MATERIAL-NR. PART NUMBER	BEZEICHNUNG DESCRIPTION	POS. NR. POS. NO.	MATERIAL-NR. PART NUMBER	BEZEICHNUNG DESCRIPTION
	295010855100	BEDIENPLATTE M.DISPLAY CONTROL BOARD W.DISPLAY			
CT 86016	830100680800	SMD TRANS BC808-40/ BC807-40			
	295010872000	NETZSCHALTERPLATTE POWER SWITCH BOARD			
L 62001	△ 295008410400	ENTSTOER-DR 2X1MH INTERFERENCE CHOKE 2X1MH			

Es gelten die Vorschriften und Sicherheitshinweise gemäß dem Service Manual "Sicherheit", Mat.-Nummer 720108000000, sowie zusätzlich die eventuell abweichenden, landesspezifischen Vorschriften!



The regulations and safety instructions shall be valid as provided by the "Safety" Service Manual, part number 720108000000, as well as the respective national deviations.

ÄNDERUNGEN VORBEHALTEN / SUBJECT TO ALTERATION

# Ersatzteilliste Spare Parts List

8 / 2002

M 84-212/8 DOLBY

MATERIAL-NR. / PART NO.: 921846029000 BESTELL-NR. / ORDER NO.: GCI9090 ANTHRAZIT-SOFT/ANTHRACITE-SOFT  
VERSION NR./VERSION NO.: VNA

POS. NR. POS. NO.	ABB. FIG.	MATERIAL-NR. PART NUMBER	ANZ. QTY.	BEZEICHNUNG (D)	DESCRIPTION (GB)
		921846029000		M 84-212/8 DOLBY ANTHRAZIT-SOFT KEIN E-TEIL	M 84-212/8 DOLBY ANTHRACITE-SOFT NO SPARE PART
0050.000				PROGRAMM FLASH-EPROM <b>DEUTSCHLAND</b> DOWNLOAD: HTTP://PARTNERWEB. GRUNDIG.DE/KUNDENDIENST	PROGRAM FLASH EPROM <b>GERMANY</b> DOWNLOAD: HTTP://PARTNERWEB. GRUNDIG.DE/KUNDENDIENST
0050.000				PROGRAMM FLASH-EPROM <b>INTERNATIONAL</b> DOWNLOAD: WWW.GRUNDIG.DE/ PRODUKTE/KONTAKT/HAENDLERSERVICE	PROGRAM FLASH EPROM <b>INTERNATIONAL</b> DOWNLOAD: WWW.GRUNDIG.DE/ PRODUCTS/CONTACT/RESELLER SUPPORT
0229.000		296322840101		EMBLEM GRUNDIG	EMBLEM GRUNDIG
0320.000		291102866405		TYPENAUFKLEBER VNA	TYPE LABEL VNA
0950.000		292104087606		SHIFTSTECKER KPL 5 W/180 OHM	SHIFT PLUG CPL 5 W/180 OHM
0950.000		292104087306		SHIFTSTECKER KPL 4 W/330 OHM	SHIFT PLUG CPL 4 W/330 OHM
1100.000		830002082100		BILDR.A80EHZ014X121 THOMSON	PICT.TUBE A80EHZ014X121 THOMSON
1110.000	△	292013601602		ANODENKAPPE M.HOCHSPANNUNGSKABEL	ANODE CAP W.HIGH VOLTAGE CABLE
1300.000		295010854100		BEDIENEINHEIT DIGI 100	CONTROL UNIT DIGI 100
1370.000		295016395103		NETZTASTENKNOPF	KNOB POWER KEY
1390.000	△	096211130206	2	SICHERUNGSHALTER SI62501	FUSE HOLDER SI62501
1397.000	△	296288200100		FOLIE ISOLIERUNG UEBER NETZSCHALTER	FOLIE ISOLIERUNG OVER POWER SWITCH
2300.000		293051224200	X	BILDROHRPLATTE	PICT.TUBE BOARD
2410.000		720086730500		DECKEL BATTERIE TP 100 C SCHWARZ	BATTERY LID TP 100 C BLACK
		218469410200		BEDIENUNGSANLEITUNG D	OPERATING INSTRUCTIONS D
		218469410300		BEDIENUNGSANLEITUNG F/I	OPERATING INSTRUCTIONS F/I
		218469410400		BEDIENUNGSANLEITUNG GB/NL	OPERATING INSTRUCTIONS GB/NL
		218469410500		BEDIENUNGSANLEITUNG E/P	OPERATING INSTRUCTIONS E/P
		218469410600		BEDIENUNGSANLEITUNG DK/FIN	OPERATING INSTRUCTIONS DK/FIN
		218469410700		BEDIENUNGSANLEITUNG S/N	OPERATING INSTRUCTIONS S/N
		720100305000		SERVICE MANUAL D/GB	SERVICE MANUAL D/GB
		720100305400		SERVICE MANUAL D/GB 4.ERGAENZUNG	SERVICE MANUAL D/GB 4TH SUPPLEMENT
		720100305500		SERVICE MANUAL D/GB 5.ERGAENZUNG	SERVICE MANUAL D/GB 5TH SUPPLEMENT
		720100305600		SERVICE MANUAL D/GB 6.ERGAENZUNG	SERVICE MANUAL D/GB 6TH SUPPLEMENT
		297040192400	X	CHASSIS-FS-STEREO CUC 1839 DIGI 100 KEIN E-TEIL	CHASSIS TV STEREO CUC 1839 DIGI 100 NO SPARE PART
				X=SIEHE GESONDERTE E-LISTE	X=SEE SEPARATE PARTS LIST
				ALLE WEITEREN TEILE SIEHE E-LISTE M 84-212/8 DOLBY ANTHRAZIT-SOFT MAT.-NR.: 921846029000 BESTELL-NR.: GCI9090 AUSGABE 2/2001 VERSION NR.: VNM	FOR ALL OTHER PARTS SEE M 84-212/8 DOLBY ANTHRACITE-SOFT PART NO.: 921846029000 ORDER NR.: GCI9090 EDITION 2/2001 VERSION NO.: VNM

ÄNDERUNGEN VORBEHALTEN / SUBJECT TO ALTERATION

# GRUNDIG

# TV

POS. NR. POS. NO.	MATERIAL-NR. PART NUMBER	BEZEICHNUNG DESCRIPTION
	295010854100	BEDIENEINHEIT DIGI 100 CONTROL UNIT DIGI 100
C 62502	△ 851179304700	FOKO MP3/KT 0,47UF20% 275VW
L 62501	△ 295008359700	ENTSTOER-DR 2X22MH INTERFERENCE CHOKE 2X22MH
R 62503	△ 831140127500	VDR SIOV-S14K275E2S11M5
SI 62501	△ 831562250300	SI 5X20 T3,15A H 250V

POS. NR. POS. NO.	MATERIAL-NR. PART NUMBER	BEZEICHNUNG DESCRIPTION
	296257130101	
	296335950501 296335955501 (WW.)	
	295016395100 VNM 295016395103 VNA	
	295015930100	
	296026015100 VNM 296322840101 VNA	
	296366370101	

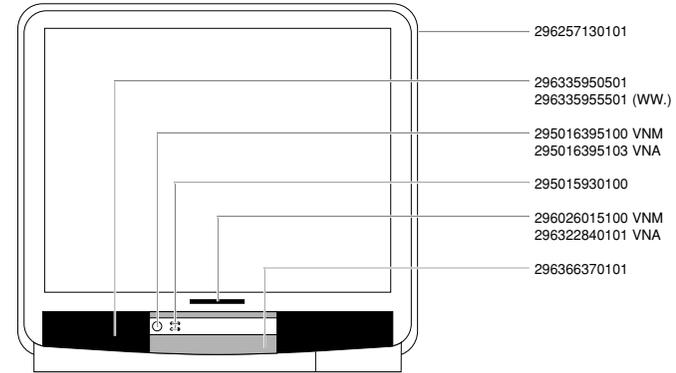

Es gelten die Vorschriften und Sicherheitshinweise gemäß dem Service Manual "Sicherheit", Mat.-Nummer 720108000000, sowie zusätzlich die eventuell abweichenden, landesspezifischen Vorschriften!



The regulations and safety instructions shall be valid as provided by the "Safety" Service Manual, part number 720108000000, as well as the respective national deviations.

ÄNDERUNGEN VORBEHALTEN / SUBJECT TO ALTERATION

## Ersatzteilliste Spare Parts List

### 8 / 2002

## LENARO 84 MF 84-6110/8 DOLBY

MATERIAL-NR. / PART NO.: 922237023700 BESTELL-NR. / ORDER NO.: GCM3000 PROCON SILBER/PROCON SILVER  
VERSION NR./VERSION NO.: VNA

POS. NR. POS. NO.	ABB. FIG.	MATERIAL-NR. PART NUMBER	ANZ. QTY.	BEZEICHNUNG ①	DESCRIPTION ②
		922237023700		LENARO 84 MF 84-6110/8 DOLBY PROCON SILBER KEIN E-TEIL	LENARO 84 MF 84-6110/8 DOLBY PROCON SILVER NO SPARE PART
0050.000				PROGRAMM FLASH-EPROM <b>DEUTSCHLAND</b> DOWNLOAD: HTTP://PARTNERWEB. GRUNDIG.DE/KUNDENDIENST	PROGRAM FLASH EPROM <b>GERMANY</b> DOWNLOAD: HTTP://PARTNERWEB. GRUNDIG.DE/KUNDENDIENST
0050.000				PROGRAMM FLASH-EPROM <b>INTERNATIONAL</b> DOWNLOAD: WWW.GRUNDIG.DE/ PRODUKTE/KONTAKT/HAENDLERSERVICE	PROGRAM FLASH EPROM <b>INTERNATIONAL</b> DOWNLOAD: WWW.GRUNDIG.DE/ PRODUCTS/CONTACT/RESELLER SUPPORT
0200.000		296355090104		GEH-VORDETEIL DRUCK KPL	CABINET FRONT PART PRINT CPL
0218.000		295017705100		TASTENKNOPF NETZ MONT. KPL	KEY KNOB POWER MOUNT. CPL
0218.000		295017700102		TASTENKNOPF NETZ	KEY KNOB POWER
0226.000		296367438101		KLAPPENLAGER LINKS	FLAP BEARING LEFT
0226.000		296367448101		KLAPPENLAGER RECHTS	FLAP BEARING RIGHT
0309.000		296367260104		ABDECKUNG RUECKTEIL OFB	COVER REAR PART SURFACE TREATED
0312.000		297006510401		ABDECKUNG DIGI-100/3EURO-AV	COVER DIGI-100/3EURO-AV
0315.000		191441179700		LAUTSPRECHER GEH-RUECKTEIL	ROUND LOUDSPEAKER CABINET REAR PART
0320.000		291104736403		TYPENAUFKLEBER VNA	TYPE LABEL VNA
0950.000		292104087606		SHIFTSTECKER KPL 5 W/180 OHM	SHIFT PLUG CPL 5 W/180 OHM
0950.000		292104087306		SHIFTSTECKER KPL 4 W/330 OHM	SHIFT PLUG CPL 4 W/330 OHM
1010.000		293051603800		BAUSTEIN EURO-AV DIGI 100	MODULE EURO-AV DIGI 100
1017.000		293031197100		EURO-AV BUCHSENLEISTE 21-POL BLAU	EURO-AV SOCKET STRIP 21 PLS BLUE
		222379410201		BEDIENUNGSANLEITUNG D	OPERATING INSTRUCTIONS D
		222379410301		BEDIENUNGSANLEITUNG F/I	OPERATING INSTRUCTIONS F/I
		222379410401		BEDIENUNGSANLEITUNG GB/NL	OPERATING INSTRUCTIONS GB/NL
		222379410501		BEDIENUNGSANLEITUNG E/P	OPERATING INSTRUCTIONS E/P
		222379410601		BEDIENUNGSANLEITUNG DK/FIN	OPERATING INSTRUCTIONS DK/FIN
		222379410701		BEDIENUNGSANLEITUNG S/N	OPERATING INSTRUCTIONS S/N
		720100305000		SERVICE MANUAL D/GB	SERVICE MANUAL D/GB
		720100305400		SERVICE MANUAL D/GB 4. ERGAENZUNG	SERVICE MANUAL D/GB 4TH SUPPLEMENT
		720100305500		SERVICE MANUAL D/GB 5. ERGAENZUNG	SERVICE MANUAL D/GB 5TH SUPPLEMENT
		720100305600		SERVICE MANUAL D/GB 6. ERGAENZUNG	SERVICE MANUAL D/GB 6TH SUPPLEMENT
				ALLE WEITEREN TEILE SIEHE E-LISTE LENARO 84 MF 84-6110/8 DOLBY PROCON SILBER MAT.-NR.: 922237023700 BESTELL-NR.: GCM3000 AUSGABE 8/2001 VERSION NR.: VNM	FOR ALL OTHER PARTS SEE LENARO 84 MF 84-6110/8 DOLBY PROCON SILVER PART NO.: 922237023700 ORDER NR.: GCM3000 EDITION 8/2001 VERSION NO.: VNM

ÄNDERUNGEN VORBEHALTEN / SUBJECT TO ALTERATION

POS. NR. POS. NO.	MATERIAL-NR. PART NUMBER	BEZEICHNUNG DESCRIPTION	POS. NR. POS. NO.	MATERIAL-NR. PART NUMBER	BEZEICHNUNG DESCRIPTION
	293051603800	BAUSTEIN EURO-AV DIGI 100 MODULE EURO-AV DIGI 100			
CD 43334	830953414900	MELF-DIODE LL 4148			
CIC 43310	830578705300	SMD IC 74HC4053			
CT 43305	830100484800	SMD TRANS BC848B/ BC847B			
CT 43315	830100385800	SMD TRANS BC858B/ BC857B			
CT 43320	830100385800	SMD TRANS BC858B/ BC857B			
CT 43330	830100484800	SMD TRANS BC848B/ BC847B			
CT 43340	830100484800	SMD TRANS BC848B/ BC847B			
CT 43360	830100484800	SMD TRANS BC848B/ BC847B			
CT 43365	830100484800	SMD TRANS BC848B/ BC847B			
	295010872100	NETZSCHALTERPLATTE DIGI 100 POWER SWITCH BOARD DIGI 100			
C 62502	△ 851179384700	FOKO MKP336.2 0,47UF 20% 275VW			
L 62501	△ 295008350400	ENTSTOER-DR 2X19MH			
R 62503	831140127500	VDR SIOV-S14K275E2S11M5			

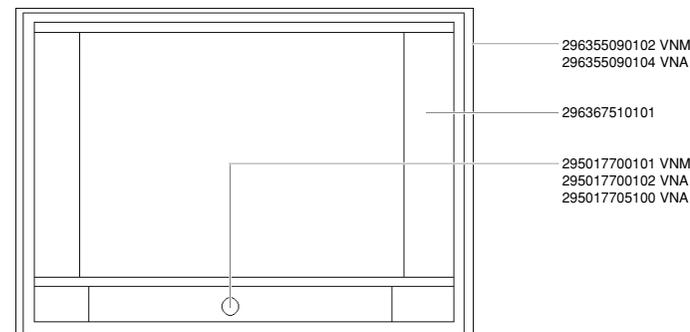

Es gelten die Vorschriften und Sicherheitshinweise gemäß dem Service Manual "Sicherheit", Mat.-Nummer 720108000000, sowie zusätzlich die eventuell abweichenden, landesspezifischen Vorschriften!



The regulations and safety instructions shall be valid as provided by the "Safety" Service Manual, part number 720108000000, as well as the respective national deviations.

ÄNDERUNGEN VORBEHALTEN / SUBJECT TO ALTERATION

### Ersatzteilliste Spare Parts List

### 8 / 2002

### LENARO 84 MF 84-6110/8 DOLBY

MATERIAL-NR. / PART NO.: 922237023700 BESTELL-NR. / ORDER NO.: GCM3000 PROCON SILBER/PROCON SILVER  
VERSION NR./VERSION NO.: VNX

POS. NR. POS. NO.	ABB. FIG.	MATERIAL-NR. PART NUMBER	ANZ. QTY.	BEZEICHNUNG D	DESCRIPTION GB
		922237023700		LENARO 84 MF 84-6110/8 DOLBY PROCON SILBER KEIN E-TEIL	LENARO 84 MF 84-6110/8 DOLBY PROCON SILVER NO SPARE PART
0050.000				PROGRAMM FLASH-EPROM <b>DEUTSCHLAND</b> DOWNLOAD: HTTP://PARTNERWEB. GRUNDIG.DE/KUNDENDIENST PROGRAMM FLASH-EPROM <b>INTERNATIONAL</b> DOWNLOAD: WWW.GRUNDIG.DE/ PRODUKTE/KONTAKT/HAENDLERSERVICE	PROGRAM FLASH EPROM <b>GERMANY</b> DOWNLOAD: HTTP://PARTNERWEB. GRUNDIG.DE/KUNDENDIENST PROGRAM FLASH EPROM <b>INTERNATIONAL</b> DOWNLOAD: WWW.GRUNDIG.DE/ PRODUCTS/CONTACT/RESELLER SUPPORT
0200.000		296355090104		GEH-VORDETEIL DRUCK KPL	CABINET FRONT PART PRINT CPL
0218.000		295017705100		TASTENKNOPF NETZ MONT. KPL	KEY KNOB POWER MOUNT. CPL
0218.000		295017700102		TASTENKNOPF NETZ	KEY KNOB POWER
0226.000		296367438101		KLAPPENLAGER LINKS	FLAP BEARING LEFT
0226.000		296367448101		KLAPPENLAGER RECHTS	FLAP BEARING RIGHT
0309.000		296367260104		ABDECKUNG RUECKTEIL OFB	COVER REAR PART SURFACE TREATED
0312.000		297006510401		ABDECKUNG DIGI-100/3EURO-AV	COVER DIGI-100/3EURO-AV
0315.000		191441179700		LAUTSPRECHER GEH-RUECKTEIL	ROUND LOUDSPEAKER CABINET REAR PART
0320.000		291104736503		TYPENAUFKLEBER VNX	TYPE LABEL VNX
0350.000		296384610103	8	ZWISCHENSTUECK RUECKWANDBEF.	INTERMEDIATE PIECE REAR PANEL FIXING
0950.000		292104087606		SHIFTSTECKER KPL 5 W/180 OHM	SHIFT PLUG CPL 5 W/180 OHM
0950.000		292104087306		SHIFTSTECKER KPL 4 W/330 OHM	SHIFT PLUG CPL 4 W/330 OHM
1010.000		293051603800		BAUSTEIN EURO-AV DIGI 100	MODULE EURO-AV DIGI 100
1017.000		293031197100		EURO-AV BUCHSENLEISTE 21-POL BLAU	EURO-AV SOCKET STRIP 21 PLS BLUE
		222379410201		BEDIENUNGSANLEITUNG D	OPERATING INSTRUCTIONS D
		222379410301		BEDIENUNGSANLEITUNG F/I	OPERATING INSTRUCTIONS F/I
		222379410401		BEDIENUNGSANLEITUNG GB/NL	OPERATING INSTRUCTIONS GB/NL
		222379410501		BEDIENUNGSANLEITUNG E/P	OPERATING INSTRUCTIONS E/P
		222379410601		BEDIENUNGSANLEITUNG DK/FIN	OPERATING INSTRUCTIONS DK/FIN
		222379410701		BEDIENUNGSANLEITUNG S/N	OPERATING INSTRUCTIONS S/N
		720100305000		SERVICE MANUAL D/GB	SERVICE MANUAL D/GB
		720100305400		SERVICE MANUAL D/GB 4. ERGAENZUNG	SERVICE MANUAL D/GB 4TH SUPPLEMENT
		720100305500		SERVICE MANUAL D/GB 5. ERGAENZUNG	SERVICE MANUAL D/GB 5TH SUPPLEMENT
		720100305600		SERVICE MANUAL D/GB 6. ERGAENZUNG	SERVICE MANUAL D/GB 6TH SUPPLEMENT
		297040198900	X	CHASSIS-FS-STEREO CUC 1839 DIGI 100 KEIN E-TEIL	CHASSIS TV STEREO CUC 1839 DIGI 100 NO SPARE PART
				X=SIEHE GESONDERTE E-LISTE	X=SEE SEPARATE PARTS LIST
				ALLE WEITEREN TEILE SIEHE E-LISTE LENARO 84 MF 84-6110/8 DOLBY PROCON SILBER MAT.-NR.: 922237023700 BESTELL-NR.: GCM3000 AUSGABE 8/2001 VERSION NR.: VNM	FOR ALL OTHER PARTS SEE LENARO 84 MF 84-6110/8 DOLBY PROCON SILVER PART NO.: 922237023700 ORDER NR.: GCM3000 EDITION 8/2001 VERSION NO.: VNM

POS. NR. POS. NO.	MATERIAL-NR. PART NUMBER	BEZEICHNUNG DESCRIPTION
	293051603800	BAUSTEIN EURO-AV DIGI 100 MODULE EURO-AV DIGI 100
CD 43334	830953414900	MELF-DIODE LL 4148
CIC 43310	830578705300	SMD IC 74HC4053
CT 43305	830100484800	SMD TRANS BC848B/ BC847B
CT 43315	830100385800	SMD TRANS BC858B/ BC857B
CT 43320	830100385800	SMD TRANS BC858B/ BC857B
CT 43330	830100484800	SMD TRANS BC848B/ BC847B
CT 43340	830100484800	SMD TRANS BC848B/ BC847B
CT 43360	830100484800	SMD TRANS BC848B/ BC847B
CT 43365	830100484800	SMD TRANS BC848B/ BC847B
	295010872100	NETZSCHALTERPLATTE DIGI 100 POWER SWITCH BOARD DIGI 100
C 62502	△ 851179384700	FOKO MKP336.2 0,47UF 20% 275VW
L 62501	△ 295008350400	ENTSTOER-DR 2X19MH
R 62503	831140127500	VDR SIOV-S14K275E2S11M5

POS. NR. POS. NO.	MATERIAL-NR. PART NUMBER	BEZEICHNUNG DESCRIPTION
	296355090102	VNM
	296355090104	VNA/VNX
	296367510101	
	295017700101	VNM
	295017700102	VNA/VNX
	295017705100	VNA/VNX

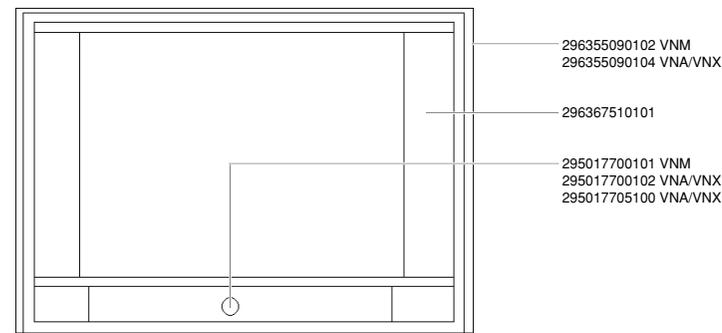

Es gelten die Vorschriften und Sicherheitshinweise gemäß dem Service Manual "Sicherheit", Mat.-Nummer 720108000000, sowie zusätzlich die eventuell abweichenden, landesspezifischen Vorschriften!



The regulations and safety instructions shall be valid as provided by the "Safety" Service Manual, part number 720108000000, as well as the respective national deviations.

## Ersatzteilliste Spare Parts List

### 7 / 2002

### ELEGANCE 70 MW 70-150/8 DOLBY

MATERIAL-NR. / PART NO.: 921848024000 BESTELL-NR. / ORDER NO.: GCI9142 PROCON SILBER/PROCON SILVER  
VERSION NR./VERSION NO.: VNA

POS. NR. POS. NO.	ABB. FIG.	MATERIAL-NR. PART NUMBER	ANZ. QTY.	BEZEICHNUNG D	DESCRIPTION GB
		921848024000		ELEGANCE 70 MW 70-150/8 DOLBY PROCON SILBER KEIN E-TEIL	ELEGANCE 70 MW 70-150/8 DOLBY PROCON SILVER NO SPARE PART
0050.000				PROGRAMM FLASH-EPROM <b>DEUTSCHLAND</b> DOWNLOAD: HTTP://PARTNERWEB. GRUNDIG.DE/KUNDENDIENST	PROGRAM FLASH EPROM <b>GERMANY</b> DOWNLOAD: HTTP://PARTNERWEB. GRUNDIG.DE/KUNDENDIENST
0050.000				PROGRAMM FLASH-EPROM <b>INTERNATIONAL</b> DOWNLOAD: WWW.GRUNDIG.DE/ PRODUKTE/KONTAKT/HAENDLERSERVICE	PROGRAM FLASH EPROM <b>INTERNATIONAL</b> DOWNLOAD: WWW.GRUNDIG.DE/ PRODUCTS/CONTACT/RESELLER SUPPORT
0201.000		191260459700	2	LS-KOMBI	LOUDSPEAKER COMBI
0206.000		296367220101		SCHALLWAND RECHTS M.VLIES	BAFFLE RHS W.FLEECE CPL
0206.000		296367230101		SCHALLWAND LINKS M.VLIES	BAFFLE LHS W.FLEECE CPL
0214.000		295017610104		BEDIENEINSATZ MONTIERT KPL	CONTROL INSERT MOUNTED CPL
0225.000		295017620104		KLAPPE DRUCK KPL BEDIENEINSATZ	FLAP PRINT CPL CONTROL INSERT
0300.000		296366050301		GEH-RUECKTEIL OFB	CABINET REAR PART SURFACE TREATED
0312.000		297006510104		ABDECKUNG DIGI-100	COVER DIGI-100
0320.000		291104996401		TYPENAUFKLEBER VNA	TYPE LABEL SELF ADHESIVE VNA
0950.000		292104087306		SHIFTSTECKER KPL 4W/330 OHM	SHIFT PLUG CPL 4W/330 OHM
0950.000		292104087606		SHIFTSTECKER KPL 5W/180 OHM	SHIFT PLUG CPL 5W/180 OHM
1100.000		830006620400		BILDROHR W 66 ESF002X44 PHILIPS	PICTURE TUBE W 66 ESF002X44 PHILIPS
2410.000		720086730000		DECKEL BATTERIE	BATTERY LID
218489410200				BEDIENUNGSANLEITUNG D	OPERATION INSTRUCTIONS D
218489410300				BEDIENUNGSANLEITUNG F/I	OPERATION INSTRUCTIONS F/I
218489410400				BEDIENUNGSANLEITUNG GB/NL	OPERATION INSTRUCTIONS GB/NL
218489410500				BEDIENUNGSANLEITUNG E/P	OPERATION INSTRUCTIONS E/P
218489410600				BEDIENUNGSANLEITUNG DK/FIN	OPERATION INSTRUCTIONS DK/FIN
218489410700				BEDIENUNGSANLEITUNG S/N	OPERATION INSTRUCTIONS S/N
720100305000				SERVICE MANUAL D/GB	SERVICE MANUAL D/GB
720100305400				SERVICE MANUAL D/GB 4.ERGAENZUNG	SERVICE MANUAL D/GB 4TH SUPPLEMENT
720100305500				SERVICE MANUAL D/GB 5.ERGAENZUNG	SERVICE MANUAL D/GB 5TH SUPPLEMENT
720100305600				SERVICE MANUAL D/GB 6.ERGAENZUNG	SERVICE MANUAL D/GB 6TH SUPPLEMENT
297040191400	X			CHASSIS-FS-STEREO DIGI 100 CUC 1934 KEIN E-TEIL	CHASSIS TV STEREO DIGI 100 CUC 1934 NO SPARE PART
				X = SIEHE GESONDERTE E-LISTE	X = SEE SEPARATE PARTS LIST
				ALLE ANDEREN TEILE SIEHE E-LISTE ELEGANCE 70 MW 70-150/8 DOLBY MAT.-NR: 921848024000 BESTELL-NR: GCI9142 AUSGABE 11/2000 VERSION-NR.: VNM	FOR ALL OTHER PARTS SEE ELEGANCE 70 MW 70-150/8 DOLBY PART NO: 921848024000 ORDER NO: GCI9142 EDITION 11/2000 VERSION NO.: VNM

ÄNDERUNGEN VORBEHALTEN / SUBJECT TO ALTERATION

POS. NR. MATERIAL-NR. BEZEICHNUNG  
POS. NO. PART NUMBER DESCRIPTION

POS. NR. MATERIAL-NR. BEZEICHNUNG  
POS. NO. PART NUMBER DESCRIPTION

### ELEGANCE 70 MW 70-150/8 DOLBY

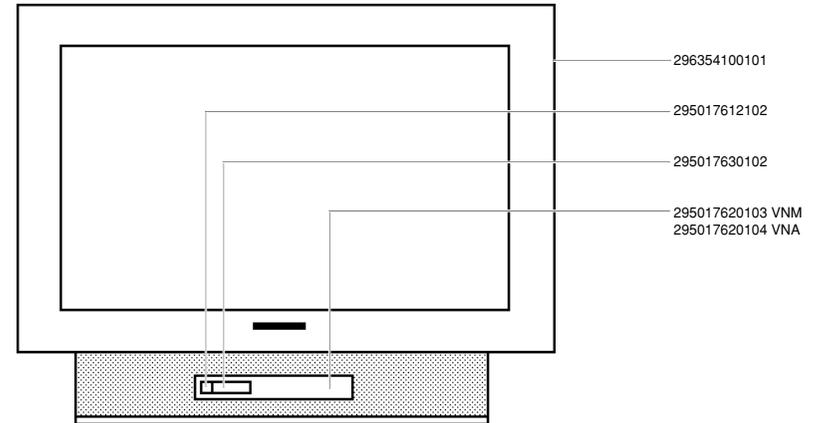

Es gelten die Vorschriften und Sicherheitshinweise gemäß dem Service Manual "Sicherheit", Mat.-Nummer 720108000000, sowie zusätzlich die eventuell abweichenden, landesspezifischen Vorschriften!



The regulations and safety instructions shall be valid as provided by the "Safety" Service Manual, part number 720108000000, as well as the respective national deviations.

ÄNDERUNGEN VORBEHALTEN / SUBJECT TO ALTERATION

# Ersatzteilliste Spare Parts List

# GRUNDIG

# TV

## 8 / 2002

## XENTIA 70 FLAT MFW 70-430/8 DOLBY

MATERIAL-NR. / PART NO.: 921915024000 BESTELL-NR. / ORDER NO.: GCK9677 PROCON-SILBER/PROCON SILVER  
VERSION NR./VERSION NO.: VNA

POS. NR. POS. NO.	ABB. FIG.	MATERIAL-NR. PART NUMBER	ANZ. QTY.	BEZEICHNUNG (D)	DESCRIPTION (GB)
		921915024000		XENTIA 70 FLAT MFW 70-430/8 DOLBY PROCON-SILBER KEIN E-TEIL	XENTIA 70 FLAT MFW 70-430/8 GB/DOLBY PROCON SILVER NO SPARE PART
0050.000				PROGRAMM FLASH-EPROM <b>DEUTSCHLAND</b> DOWNLOAD: HTTP://PARTNERWEB. GRUNDIG.DE/KUNDENDIENST	PROGRAM FLASH EPROM <b>GERMANY</b> DOWNLOAD: HTTP://PARTNERWEB. GRUNDIG.DE/KUNDENDIENST
0050.000				PROGRAMM FLASH-EPROM <b>INTERNATIONAL</b> DOWNLOAD: WWW.GRUNDIG.DE/ PRODUKTE/KONTAKT/HAENDLERSERVICE	PROGRAM FLASH EPROM <b>INTERNATIONAL</b> DOWNLOAD: WWW.GRUNDIG.DE/ PRODUCTS/CONTACT/RESELLER SUPPORT
0201.000		191260466101	2	LAUTSPRECHER KOMBI 8 OHM	SPEAKER COMBI 8 OHM
0217.000		296383400203		BODENPLATTE KPL	BOTTOM PANEL CPL
0218.000		295018080101		NETZTASTENKNOPF DRUCK KPL	POWER KEY KNOB PRINT CPL
0300.000		296363880502		GEH-RUECKTEIL OFB	CABINET REAR PART SURFACE TREA
0312.000		297006510103		ABDECKUNG DIGI-100	COVER DIGI-100
0320.000		291105086401		TYPENAUFKLEBER VNA	TYPE LABEL VNA
0953.000		293035220600		S-VHS-BUCHSE O.SCHALTER	S-VHS-SOCKET W/O WIPER
2410.000		720086731000		DECKEL BATTERIE TP110 C	BATTERY LID TP110 C
		219159410300		BEDIENUNGSANLEITUNG D	OPERATING INSTRUCTIONS D
		219159410400		BEDIENUNGSANLEITUNG F/I	OPERATING INSTRUCTIONS F/I
		219159410500		BEDIENUNGSANLEITUNG GB/NL	OPERATING INSTRUCTIONS GB/NL
		219159410600		BEDIENUNGSANLEITUNG E/P	OPERATING INSTRUCTIONS E/P
		219159410700		BEDIENUNGSANLEITUNG DK/FIN	OPERATING INSTRUCTIONS DK/FIN
		219159410800		BEDIENUNGSANLEITUNG S/N	OPERATING INSTRUCTIONS S/N
		720100305000		SERVICE MANUAL D/GB	SERVICE MANUAL D/GB
		720100305400		SERVICE MANUAL D/GB 4.ERGAENZUNG	SERVICE MANUAL D/GB 4TH SUPPLEMENT
		720100305500		SERVICE MANUAL D/GB 5.ERGAENZUNG	SERVICE MANUAL D/GB 5TH SUPPLEMENT
		720100305600		SERVICE MANUAL D/GB 6.ERGAENZUNG	SERVICE MANUAL D/GB 6TH SUPPLEMENT
		297040193000	X	CHASSIS-FS-STEREO CUC 1934 DIGI 100 KEIN E-TEIL	CHASSIS TV STEREO CUC 1934 DIGI 100 NO SPARE PART
				X-SIEHE GESONDERT E-LISTE	X-SEE SEPARATE PARTS LIST
				ALLE WEITEREN TEILE SIEHE E-LISTE XENTIA 70 FLAT MFW 70-430/8 DOLBY MAT.-NR.:921915024000 BESTELL-NR.:GCK9677 AUSGABE 1/2001 VERSION NR.: VNM	FOR ALL ORTHER PARTS SEE XENTIA 70 FLAT MFW 70-430/8 DOLBY PART NO.:921915024000 ORDNER NO.:GCK9677 EDITION 1/2001 VERSION NO.: VNM

ÄNDERUNGEN VORBEHALTEN / SUBJECT TO ALTERATION

POS. NR. MATERIAL-NR. BEZEICHNUNG  
POS. NO. PART NUMBER DESCRIPTION

POS. NR. MATERIAL-NR. BEZEICHNUNG  
POS. NO. PART NUMBER DESCRIPTION

## XENTIA 70 FLAT MFW 70-430/8 DOLBY

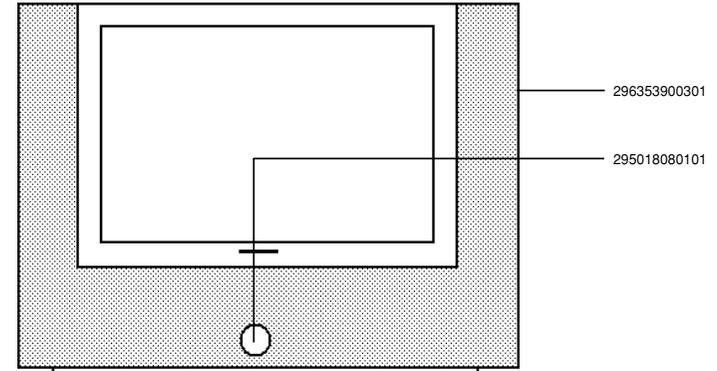

Es gelten die Vorschriften und Sicherheitshinweise gemäß dem Service Manual "Sicherheit", Mat.-Nummer 720108000000, sowie zusätzlich die eventuell abweichenden, landesspezifischen Vorschriften!



The regulations and safety instructions shall be valid as provided by the "Safety" Service Manual, part number 720108000000, as well as the respective national deviations.

ÄNDERUNGEN VORBEHALTEN / SUBJECT TO ALTERATION

### Ersatzteilliste Spare Parts List

9 / 2002

### ARGANTO 70 MW 70-515 MV/DOLBY

MATERIAL-NR. / PART NO.: 922209029200 BESTELL-NR. / ORDER NO.: GCM5800 TITANE  
VERSION NR./VERSION NO.: VNA

POS. NR. POS. NO.	ABB. FIG.	MATERIAL-NR. PART NUMBER	ANZ. QTY.	BEZEICHNUNG (D)	DESCRIPTION (GB)
		922209029200		ARGANTO 70 MW 70-515 MV/DOLBY TITANE KEIN E-TEIL	ARGANTO 70 MW 70-515 MV/DOLBY TITANE NO SPARE PART
0050.000				PROGRAMM FLASH-EPROM <b>DEUTSCHLAND</b> DOWNLOAD: HTTP://PARTNERWEB. GRUNDIG.DE/KUNDENDIENST	PROGRAM FLASH EPROM <b>GERMANY</b> DOWNLOAD: HTTP://PARTNERWEB. GRUNDIG.DE/KUNDENDIENST
0050.000				PROGRAMM FLASH-EPROM <b>INTERNATIONAL</b> DOWNLOAD: WWW.GRUNDIG.DE/ PRODUKTE/KONTAKT/HAENDLERSERVICE	PROGRAM FLASH EPROM <b>INTERNATIONAL</b> DOWNLOAD: WWW.GRUNDIG.DE/ PRODUCTS/CONTACT/RESELLER SUPPORT
0207.000 0208.000 0320.000 1100.000 1302.000 1352.000		296381380402 297006510104 291105186401 830006620400 293033751002 296367010403	2	ABDECKUNG SCHALLWAND OFB ABDECKUNG DIGI-100 TYPENAUFKLEBER VNA BILDR.W 66 ESF 002X44 PHILIPS SCHENKELFEDER KLAPPE DRUCK CPL	COVER BAFFLE SURFACE TREATED COVER DIGI-100 TYPE LABEL VNA PICT.TUBE W 66 ESF 002X44 PHILIPS LEG SPRING FLAP PRINT CPL
		222099410200 222099410300 222099410400 222099410500 222099410600 222099410700 720100305000 720100305400 720100305500 720100305600		BEDIENUNGSANLEITUNG D BEDIENUNGSANLEITUNG F/I BEDIENUNGSANLEITUNG GB/NL BEDIENUNGSANLEITUNG E/P BEDIENUNGSANLEITUNG DK/FIN BEDIENUNGSANLEITUNG S/N SERVICE MANUAL D/GB SERVICE MANUAL D/GB 4.ERGAENZUNG SERVICE MANUAL D/GB 5.ERGAENZUNG SERVICE MANUAL D/GB 6.ERGAENZUNG	OPERATING INSTRUCTIONS D OPERATING INSTRUCTIONS F/I OPERATING INSTRUCTIONS GB/NL OPERATING INSTRUCTIONS E/P OPERATING INSTRUCTIONS DK/FIN OPERATING INSTRUCTIONS S/N SERVICE MANUAL D/GB SERVICE MANUAL D/GB 4TH SUPPLEMENT SERVICE MANUAL D/GB 5TH SUPPLEMENT SERVICE MANUAL D/GB 6TH SUPPLEMENT
		297040190600	X	CHASSIS-FS-STEREO CUC 1934 DIGI 100 KEIN E-TEIL  X=SIEHE GESONDERTE E-LISTE	CHASSIS TV STEREO CUC 1934 DIGI 100 NO SPARE PART  X=SEE SEPARATE PARTS LIST
				ALLE WEITEREN TEILE SIEHE E-LISTE ARGANTO 70 MW 70-515 MV/DOLBY TITANE MAT.-NR.:922209029200 BESTELL-NR.:GCM5800 AUSGABE 5/2001 VERSION NR.: VNM	FOR ALL ORTHER PARTS SEE ARGANTO 70 MW 70-515 MV/DOLBY TITANE PART NO:922209029200 ORDNER NO.:GCM5800 EDITION 5/2001 VERSION NO.: VNM

### Ersatzteilliste Spare Parts List

8 / 2002

### ELEGANCE 82 MW 82-150/8 DOLBY

MATERIAL-NR. / PART NO.: 921847024000 BESTELL-NR. / ORDER NO.: GCI9242 PROCON-SILBER/PROCON-SILVER  
VERSION NR./VERSION NO.: VNA

POS. NR. POS. NO.	ABB. FIG.	MATERIAL-NR. PART NUMBER	ANZ. QTY.	BEZEICHNUNG (D)	DESCRIPTION (GB)
		921847024000		ELEGANCE 82 MW 82-150/8 DOLBY PROCON-SILBER KEIN E-TEIL	ELEGANCE 82 MW 82-150/8 DOLBY PROCON-SILBER NO SPARE PART
0050.000				PROGRAMM FLASH-EPROM <b>DEUTSCHLAND</b> DOWNLOAD: HTTP://PARTNERWEB. GRUNDIG.DE/KUNDENDIENST	PROGRAM FLASH EPROM <b>GERMANY</b> DOWNLOAD: HTTP://PARTNERWEB. GRUNDIG.DE/KUNDENDIENST
0050.000				PROGRAMM FLASH-EPROM <b>INTERNATIONAL</b> DOWNLOAD: WWW.GRUNDIG.DE/ PRODUKTE/KONTAKT/HAENDLERSERVICE	PROGRAM FLASH EPROM <b>INTERNATIONAL</b> DOWNLOAD: WWW.GRUNDIG.DE/ PRODUCTS/CONTACT/RESELLER SUPPORT
0201.000 0206.000 0206.000 0300.000 0312.000 0320.000 0900.000 0950.000 0950.000 1100.000 1300.000 1301.000 2410.000		191260459700 296367220101 296367230101 296366030301 297006510104 291105126401 292014771102 292104087306 292104087606 830007623000 295017610104 295017623102 720086730000	2	LS-KOMBI 8 OHM SCHALLWAND RECHTS M.VLIES KPL SCHALLWAND LINKS M.VLIES KPL GEH-RUECKTEIL OFB ABDECKUNG DIGI-100 TYPENAUFKLEBER VNA FOKUS U.UG2-REGLER SHIFTSTECKER KPL 4 W/330 OHM SHIFTSTECKER KPL 5 W/180 OHM BILDR.W 76 ESF 031X44 PHILIPS BEDIENEINSATZ MONT.KPL KLAPPE DRUCK KPL DECKEL BATTERIE TP 100 C	SPEAKER COMBI 8 OHM BAFFLE RHS W.FLEECE CPL BAFFLE LHS W.FLEECE CPL CABINET REAR PART SURFACE TREA COVER DIGI-100 TYPE LABEL VNA FOCUS AND UG2-CONTROLLER SHIFT PLUG CPL 4 W/330 OHM SHIFT PLUG CPL 5 W/180 OHM PICT.TUBE W 76 ESF 031X44 PHILIPS CONTROL INSERT MOUNT.CPL FLAP PRINT CPL BATTERY LID TP 100 C
		218479410200 218479410300 218479410400 218479410500 218479410600 218479410700 720100305000 720100305400 720100305500 720100305600		BEDIENUNGSANLEITUNG D BEDIENUNGSANLEITUNG F/I BEDIENUNGSANLEITUNG E/P BEDIENUNGSANLEITUNG S/N BEDIENUNGSANLEITUNG DK/FIN BEDIENUNGSANLEITUNG GB/NL SERVICE MANUAL D/GB SERVICE MANUAL D/GB 4.ERGAENZUNG SERVICE MANUAL D/GB 5.ERGAENZUNG SERVICE MANUAL D/GB 6.ERGAENZUNG	OPERATING INSTRUCTIONS D OPERATING INSTRUCTIONS F/I OPERATING INSTRUCTIONS E/P OPERATING INSTRUCTIONS S/N OPERATING INSTRUCTIONS DK/FIN OPERATING INSTRUCTIONS GB/NL SERVICE MANUAL D/GB SERVICE MANUAL D/GB 4TH SUPPLEMENT SERVICE MANUAL D/GB 5TH SUPPLEMENT SERVICE MANUAL D/GB 6TH SUPPLEMENT
		297040191500	X	CHASSIS-FS-STEREO CUC 1935 DIGI 100 KEIN E-TEIL  X=SIEHE GESONDERTE E-LISTE	CHASSIS TV STEREO CUC 1935 DIGI 100 NO SPARE PART  X=SEE SEPARATE PARTS LIST
				ALLE WEITEREN TEILE SIEHE E-LISTE ELEGANCE 82 MW 82-150/8 DOLBY MAT.-NR.:921847024000 BESTELL-NR.:GCI9242 AUSGABE 11/2000 VERSION NR.: VNM	FOR ALL ORTHER PARTS SEE ELEGANCE 82 MW 82-150/8 DOLBY PART NO:921847024000 ORDNER NO.:GCI9242 EDITION 11/2000 VERSION NO.: VNM

Es gelten die Vorschriften und Sicherheitshinweise gemäß dem Service Manual "Sicherheit", Mat.-Nummer 720108000000, sowie zusätzlich die eventuell abweichenden, landesspezifischen Vorschriften!



The regulations and safety instructions shall be valid as provided by the "Safety" Service Manual, part number 720108000000, as well as the respective national deviations.

ÄNDERUNGEN VORBEHALTEN / SUBJECT TO ALTERATION

Es gelten die Vorschriften und Sicherheitshinweise gemäß dem Service Manual "Sicherheit", Mat.-Nummer 720108000000, sowie zusätzlich die eventuell abweichenden, landesspezifischen Vorschriften!



The regulations and safety instructions shall be valid as provided by the "Safety" Service Manual, part number 720108000000, as well as the respective national deviations.

ÄNDERUNGEN VORBEHALTEN / SUBJECT TO ALTERATION

Ersatzteilliste  
Spare Parts List

8 / 2002

ELEGANCE 82 MW 82-150/8 DOLBY

MATERIAL-NR. / PART NO.: 921847029200 BESTELL-NR. / ORDER NO.: GCI9292 TITANE  
VERSION NR./VERSION NO.: VNA

POS. NR. POS. NO.	ABB. FIG.	MATERIAL-NR. PART NUMBER	ANZ. QTY.	BEZEICHNUNG (D)	DESCRIPTION (GB)
		921847029200		ELEGANCE 82 MW 82-150/8 DOLBY TITANE KEIN E-TEIL	ELEGANCE 82 MW 82-150/8 DOLBY TITANE NO SPARE PART
0050.000		PROGRAMM FLASH-EPROM <b>DEUTSCHLAND</b> DOWNLOAD: HTTP://PARTNERWEB. GRUNDIG.DE/KUNDENDIENST PROGRAMM FLASH-EPROM		PROGRAMM FLASH-EPROM <b>GERMANY</b> DOWNLOAD: HTTP://PARTNERWEB. GRUNDIG.DE/KUNDENDIENST PROGRAMM FLASH-EPROM	PROGRAM FLASH EPROM <b>GERMANY</b> DOWNLOAD: HTTP://PARTNERWEB. GRUNDIG.DE/KUNDENDIENST PROGRAM FLASH EPROM
0050.000		INTERNATIONAL DOWNLOAD: WWW.GRUNDIG.DE/ PRODUKTE/KONTAKT/HAENDLERSERVICE		INTERNATIONAL DOWNLOAD: WWW.GRUNDIG.DE/ PRODUKTS/CONTACT/RESELLER SUPPORT	INTERNATIONAL DOWNLOAD: WWW.GRUNDIG.DE/ PRODUCTS/CONTACT/RESELLER SUPPORT
0312.000		297006510102		ABDECKUNG DIGI-100	COVER DIGI-100
0320.000		291105126401		TYPENAUFKLEBER VNA	TYPE LABEL VNA
0900.000	△	292014771102		FOKUS U.UG2-REGLER	FOCUS AND UG2-CONTROLLER
0950.000		292104087606		SHIFTSTECKER KPL 5 W/180 OHM	SHIFT PLUG CPL 5 W/180 OHM
0950.000		292104087306		SHIFTSTECKER KPL 4 W/330 OHM	SHIFT PLUG CPL 4 W/330 OHM
1100.000		830007623000		BILDR.W 76 ESF 031X44 PHILIPS	PICT.TUBE W 76 ESF 031X44 PHILIPS
1301.000		295017610104		BEDIENEINSATZ MONT.KPL	CONTROL INSERT MOUNT.CPL
1352.000		295017623302		KLAPPE DRUCK KPL	FLAP PRINT CPL
2410.000		720086730500		DECKEL BATTERIE TP 100 C SCHW.	BATTERY LID TP 100 C BLACK
		218479410200		BEDIENUNGSANLEITUNG D	OPERATING INSTRUCTIONS D
		218479410300		BEDIENUNGSANLEITUNG F/I	OPERATING INSTRUCTIONS F/I
		218479410400		BEDIENUNGSANLEITUNG E/P	OPERATING INSTRUCTIONS E/P
		218479410500		BEDIENUNGSANLEITUNG S/N	OPERATING INSTRUCTIONS S/N
		218479410600		BEDIENUNGSANLEITUNG DK/FIN	OPERATING INSTRUCTIONS DK/FIN
		218479410700		BEDIENUNGSANLEITUNG GB/NL	OPERATING INSTRUCTIONS GB/NL
		720100305000		SERVICE MANUAL D/GB	SERVICE MANUAL D/GB
		720100305400		SERVICE MANUAL D/GB 4.ERGAENZUNG	SERVICE MANUAL D/GB 4TH SUPPLEMENT
		720100305500		SERVICE MANUAL D/GB 5.ERGAENZUNG	SERVICE MANUAL D/GB 5TH SUPPLEMENT
		720100305600		SERVICE MANUAL D/GB 6.ERGAENZUNG	SERVICE MANUAL D/GB 6TH SUPPLEMENT
		297040191500	X	CHASSIS-FS-STEREO CUC 1935 DIGI 100 KEIN E-TEIL	CHASSIS TV STEREO CUC 1935 DIGI 100 NO SPARE PART
				X-SIEHE GESONDERTE E-LISTE	X=SEE SEPARATE PARTS LIST
				ALLE WEITEREN TEILE SIEHE E-LISTE ELEGANCE 82 MW 82-150/8 DOLBY MAT.-NR.:921847029200 BESTELL-NR.:GCI9292 AUSGABE 5/2001 VERSION NR.: VNM	FOR ALL ORTHER PARTS SEE ELEGANCE 82 MW 82-150/8 DOLBY PART NO.:921847029200 ORDNER NO.:GCI9292 EDITION 5/2001 VERSION NO.: VNM

Es gelten die Vorschriften und Sicherheitshinweise gemäß dem Service Manual "Sicherheit", Mat.-Nummer 720108000000, sowie zusätzlich die eventuell abweichenden, landesspezifischen Vorschriften!



The regulations and safety instructions shall be valid as provided by the "Safety" Service Manual, part number 720108000000, as well as the respective national deviations.

ÄNDERUNGEN VORBEHALTEN / SUBJECT TO ALTERATION

Ersatzteilliste  
Spare Parts List

7 / 2001

XENTIA 82 FLAT MFW 82-430/8 DOLBY

MATERIAL-NR. / PART NO.: 921914024000 BESTELL-NR. / ORDER NO.: GCK9577 PROCON SILBER/PROCON SILBER  
VERSION NR./VERSION NO.: VNA

POS. NR. POS. NO.	ABB. FIG.	MATERIAL-NR. PART NUMBER	ANZ. QTY.	BEZEICHNUNG (D)	DESCRIPTION (GB)
		921914024000		XENTIA 82 FLAT MFW 82-430/8 DOLBY PROCON SILBER KEIN E-TEIL	XENTIA 82 FLAT MFW 82-430/8 DOLBY PROCON SILBER NO SPARE PART
0309.000		191441179700		LAUTSPRECHER SUBWOOFER	SPEAKER SUBWOOFER
0310.000		296383390201		BASS-BOX KPL	WOOFER BOX CPL
0320.000		291102296405		TYPENAUFKLEBER VNA	TYPE LABEL SELF ADHESIVE VNA
		219149411000		BEDIENUNGSANLEITUNG D	OPERATION INSTRUCTIONS D
		219149411100		BEDIENUNGSANLEITUNG F/I	OPERATION INSTRUCTIONS F/I
		219149411200		BEDIENUNGSANLEITUNG GB/NL	OPERATION INSTRUCTIONS GB/NL
		219149411300		BEDIENUNGSANLEITUNG E/P	OPERATION INSTRUCTIONS E/P
		219149411400		BEDIENUNGSANLEITUNG DK/FIN	OPERATION INSTRUCTIONS DK/FIN
		219149411500		BEDIENUNGSANLEITUNG S/N	OPERATION INSTRUCTIONS S/N
		720100305000		SERVICE MANUAL D/GB	SERVICE MANUAL D/GB
		720100305400		SERVICE MANUAL D/GB 4.ERGAENZUNG	SERVICE MANUAL D/GB 4TH SUPPLEMENT
		720100305500		SERVICE MANUAL D/GB 5.ERGAENZUNG	SERVICE MANUAL D/GB 5TH SUPPLEMENT
		720100305600		SERVICE MANUAL D/GB 6.ERGAENZUNG	SERVICE MANUAL D/GB 6TH SUPPLEMENT
				ALLE ANDEREN TEILE SIEHE E-LISTE XENTIA 82 FLAT MFW 82-430/8 DOLBY PROCON SILBER MAT.-NR.: 921914024000 BESTELL-NR.: GCK9577 AUSGABE 4/2001 VERSION-NR.: VNM	FOR ALL OTHER PARTS SEE XENTIA 82 FLAT MFW 82-430/8 DOLBY PROCON SILBER PART NO.: 921914024000 ORDER NO.: GCK9577 EDITION 4/2001 VERSION NO.: VNM

Es gelten die Vorschriften und Sicherheitshinweise gemäß dem Service Manual "Sicherheit", Mat.-Nummer 720108000000, sowie zusätzlich die eventuell abweichenden, landesspezifischen Vorschriften!



The regulations and safety instructions shall be valid as provided by the "Safety" Service Manual, part number 720108000000, as well as the respective national deviations.

ÄNDERUNGEN VORBEHALTEN / SUBJECT TO ALTERATION

### Ersatzteilliste Spare Parts List

8 / 2002

### XENTIA 82 FLAT MFW 82-430/8 DOLBY

MATERIAL-NR. / PART NO.: 921914024000 BESTELL-NR. / ORDER NO.: GCK9577 PROCON SILBER/PROCON SILBER  
VERSION NR./VERSION NO.: VNX

POS. NR. POS. NO.	ABB. FIG.	MATERIAL-NR. PART NUMBER	ANZ. QTY.	BEZEICHNUNG (D)	DESCRIPTION (GB)
		921914024000		XENTIA 82 FLAT MFW 82-430/8 DOLBY PROCON SILBER KEIN E-TEIL	XENTIA 82 FLAT MFW 82-430/8 DOLBY PROCON SILBER NO SPARE PART
0050.000				PROGRAMM FLASH-EPROM <b>DEUTSCHLAND</b> DOWNLOAD: HTTP://PARTNERWEB. GRUNDIG.DE/KUNDENDIENST PROGRAMM FLASH-EPROM <b>INTERNATIONAL</b> DOWNLOAD: WWW.GRUNDIG.DE/ PRODUKTE/KONTAKT/HAENDLERSERVICE	PROGRAM FLASH EPROM <b>GERMANY</b> DOWNLOAD: HTTP://PARTNERWEB. GRUNDIG.DE/KUNDENDIENST PROGRAM FLASH EPROM <b>INTERNATIONAL</b> DOWNLOAD: WWW.GRUNDIG.DE/ PRODUCTS/CONTACT/RESELLER SUPPORT
0201.000		191260469701	2	LAUTSPRECHER KOMBI	SPEAKER COMBI
0218.000		295018080101		NETZTASTENKNOPF DRUCK KPL	POWER KEY KNOB PRINT CPL
0226.000		295017440103		LAGERSTUECK	BEARING
0312.000		297006510103		ABDECKUNG DIGI-100	COVER DIGI-100
0315.000		191441179700		LAUTSPRECHER TIEFTON	SUBWOOFER
0320.000		291105366501		TYPENAUFKLEBBER VNX	TYPE LABEL SELF ADHESIVE VNX
0950.000		292104087606		SHIFTSTECKER KPL 5W/180 OHM	SHIFT PLUG CPL 5W/180 OHM
0950.000		292104087306		SHIFTSTECKER KPL 4W/330 OHM	SHIFT PLUG CPL 4W/330 OHM
		293050176600		LED-PLATTE KEIN E-TEIL	DIODES BOARD NO SPARE PART
		219149411000		BEDIENUNGSANLEITUNG D	OPERATION INSTRUCTIONS D
		219149411100		BEDIENUNGSANLEITUNG F/I	OPERATION INSTRUCTIONS F/I
		219149411200		BEDIENUNGSANLEITUNG GB/NL	OPERATION INSTRUCTIONS GB/NL
		219149411300		BEDIENUNGSANLEITUNG E/P	OPERATION INSTRUCTIONS E/P
		219149411400		BEDIENUNGSANLEITUNG DK/FIN	OPERATION INSTRUCTIONS DK/FIN
		219149411500		BEDIENUNGSANLEITUNG S/N	OPERATION INSTRUCTIONS S/N
		720100305000		SERVICE MANUAL D/GB	SERVICE MANUAL D/GB
		720100305400		SERVICE MANUAL D/GB 4.ERGAENZUNG	SERVICE MANUAL D/GB 4TH SUPPLEMENT
		720100305500		SERVICE MANUAL D/GB 5.ERGAENZUNG	SERVICE MANUAL D/GB 5TH SUPPLEMENT
		720100305600		SERVICE MANUAL D/GB 6.ERGAENZUNG	SERVICE MANUAL D/GB 6TH SUPPLEMENT
		297040193300	X	CHASSIS-FS-STEREO DIGI 100 CUC 1935 KEIN E-TEIL	CHASSIS TV STEREO DIGI 100 CUC 1935 NO SPARE PART
				X = SIEHE GESONDERTE E-LISTE	X = SEE SEPARATE PARTS LIST
				ALLE ANDEREN TEILE SIEHE E-LISTE XENTIA 82 FLAT MFW 82-430/8 DOLBY PROCON SILBER MAT.-NR: 921914024000 BESTELL-NR: GCK9577 AUSGABE 4/2001 VERSION-NR.: VNM	FOR ALL OTHER PARTS SEE XENTIA 82 FLAT MFW 82-430/8 DOLBY PROCON SILBER PART NO: 921914024000 ORDER NO: GCK9577 EDITION 4/2001 VERSION NO.: VNM

ÄNDERUNGEN VORBEHALTEN / SUBJECT TO ALTERATION

POS. NR. MATERIAL-NR. BEZEICHNUNG  
POS. NO. PART NUMBER DESCRIPTION

POS. NR. MATERIAL-NR. BEZEICHNUNG  
POS. NO. PART NUMBER DESCRIPTION

### XENTIA 82 FLAT MFW 82-430/8 DOLBY

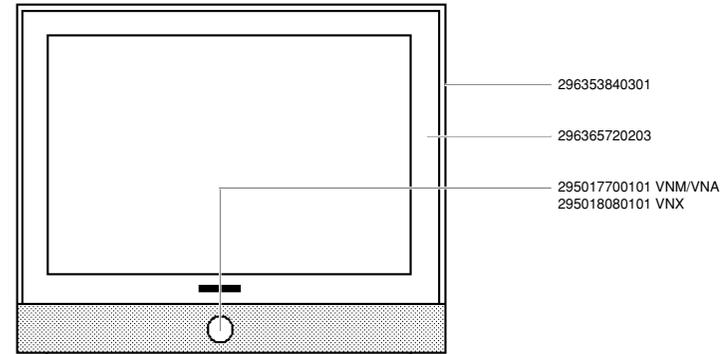

Es gelten die Vorschriften und Sicherheitshinweise gemäß dem Service Manual "Sicherheit", Mat.-Nummer 720108000000, sowie zusätzlich die eventuell abweichenden, landesspezifischen Vorschriften!



The regulations and safety instructions shall be valid as provided by the "Safety" Service Manual, part number 720108000000, as well as the respective national deviations.

ÄNDERUNGEN VORBEHALTEN / SUBJECT TO ALTERATION

### Ersatzteilliste Spare Parts List

8 / 2002

### XENTIA 82 FLAT MFW 82-430/8 DOLBY

MATERIAL-NR. / PART NO.: 921914024000 BESTELL-NR. / ORDER NO.: GCK9577 PROCON SILBER/PROCON SILBER  
VERSION NR./VERSION NO.: **VNG**

POS. NR. POS. NO.	ABB. FIG.	MATERIAL-NR. PART NUMBER	ANZ. QTY.	BEZEICHNUNG <b>(D)</b>	DESCRIPTION <b>(GB)</b>
		921914024000		XENTIA 82 FLAT MFW 82-430/8 DOLBY PROCON SILBER KEIN E-TEIL	XENTIA 82 FLAT MFW 82-430/8 DOLBY PROCON SILBER NO SPARE PART
0050.000				PROGRAMM FLASH-EPROM <b>DEUTSCHLAND</b> DOWNLOAD: HTTP://PARTNERWEB. GRUNDIG.DE/KUNDENDIENST PROGRAMM FLASH-EPROM <b>INTERNATIONAL</b> DOWNLOAD: WWW.GRUNDIG.DE/ PRODUKTE/KONTAKT/HAENDLERSERVICE	PROGRAM FLASH EPROM <b>GERMANY</b> DOWNLOAD: HTTP://PARTNERWEB. GRUNDIG.DE/KUNDENDIENST PROGRAM FLASH EPROM <b>INTERNATIONAL</b> DOWNLOAD: WWW.GRUNDIG.DE/ PRODUCTS/CONTACT/RESELLER SUPPORT
0201.000		191260466101	2	LAUTSPRECHER KOMBI	SPEAKER COMBI
0218.000		295018080101		NETZTASTENKNOPF DRUCK KPL	POWER KEY KNOB PRINT CPL
0226.000		295017440103		LAGERSTUECK	BEARING
0312.000		297006510103		ABDECKUNG DIGI-100	COVER DIGI-100
0315.000		191441179700		LAUTSPRECHER TIEFTON	SUBWOOFER
0320.000		291105366601		TYPENAUFKLEBER VNG	TYPE LABEL SELF ADHESIVE VNG
0950.000		292104087606		SHIFTSTECKER KPL 5W/180 OHM	SHIFT PLUG CPL 5W/180 OHM
0950.000		292104087306		SHIFTSTECKER KPL 4W/330 OHM	SHIFT PLUG CPL 4W/330 OHM
		293050176600		LED-PLATTE KEIN E-TEIL	DIODES BOARD NO SPARE PART
		219149411001		BEDIENUNGSANLEITUNG D	OPERATION INSTRUCTIONS D
		219149411101		BEDIENUNGSANLEITUNG F/I	OPERATION INSTRUCTIONS F/I
		219149411201		BEDIENUNGSANLEITUNG GB/NL	OPERATION INSTRUCTIONS GB/NL
		219149411301		BEDIENUNGSANLEITUNG E/P	OPERATION INSTRUCTIONS E/P
		219149411401		BEDIENUNGSANLEITUNG DK/FIN	OPERATION INSTRUCTIONS DK/FIN
		219149411501		BEDIENUNGSANLEITUNG S/N	OPERATION INSTRUCTIONS S/N
		720100305000		SERVICE MANUAL D/GB	SERVICE MANUAL D/GB
		720100305400		SERVICE MANUAL D/GB 4.ERGAENZUNG	SERVICE MANUAL D/GB 4TH SUPPLEMENT
		720100305500		SERVICE MANUAL D/GB 5.ERGAENZUNG	SERVICE MANUAL D/GB 5TH SUPPLEMENT
		720100305600		SERVICE MANUAL D/GB 6.ERGAENZUNG	SERVICE MANUAL D/GB 6TH SUPPLEMENT
				X = SIEHE GESONDERTE E-LISTE	X = SEE SEPARATE PARTS LIST
				ALLE ANDEREN TEILE SIEHE E-LISTE XENTIA 82 FLAT MFW 82-430/8 DOLBY PROCON SILBER MAT.-NR: 921914024000 BESTELL-NR: GCK9577 AUSGABE 4/2001 VERSION-NR.: <b>VNM</b>	FOR ALL OTHER PARTS SEE XENTIA 82 FLAT MFW 82-430/8 DOLBY PROCON SILBER PART NO: 921914024000 ORDER NO: GCK9577 EDITION 4/2001 VERSION NO.: <b>VNM</b>

ÄNDERUNGEN VORBEHALTEN / SUBJECT TO ALTERATION

POS. NR. MATERIAL-NR. BEZEICHNUNG  
POS. NO. PART NUMBER DESCRIPTION

POS. NR. MATERIAL-NR. BEZEICHNUNG  
POS. NO. PART NUMBER DESCRIPTION

### XENTIA 82 FLAT MFW 82-430/8 DOLBY

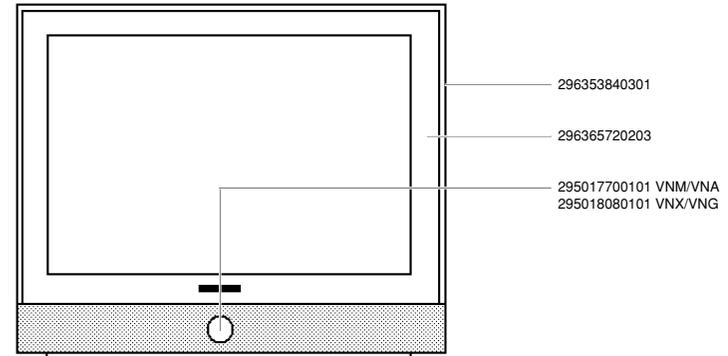

Es gelten die Vorschriften und Sicherheitshinweise gemäß dem Service Manual "Sicherheit", Mat.-Nummer 720108000000, sowie zusätzlich die eventuell abweichenden, landesspezifischen Vorschriften!



The regulations and safety instructions shall be valid as provided by the "Safety" Service Manual, part number 720108000000, as well as the respective national deviations.

ÄNDERUNGEN VORBEHALTEN / SUBJECT TO ALTERATION

### Ersatzteilliste Spare Parts List

8 / 2002

### XENTIA 82 FLAT MFW 82-430/8 DOLBY

MATERIAL-NR. / PART NO.: 921914024000 BESTELL-NR. / ORDER NO.: GCK9577 PROCON SILBER/PROCON SILBER  
VERSION NR./VERSION NO.: VNR

POS. NR. POS. NO.	ABB. FIG.	MATERIAL-NR. PART NUMBER	ANZ. QTY.	BEZEICHNUNG (D)	DESCRIPTION (GB)
		921914024000		XENTIA 82 FLAT MFW 82-430/8 DOLBY PROCON SILBER KEIN E-TEIL	XENTIA 82 FLAT MFW 82-430/8 DOLBY PROCON SILBER NO SPARE PART
0050.000				PROGRAMM FLASH-EPROM <b>DEUTSCHLAND</b> DOWNLOAD: HTTP://PARTNERWEB. GRUNDIG.DE/KUNDENDIENST	PROGRAM FLASH EPROM <b>GERMANY</b> DOWNLOAD: HTTP://PARTNERWEB. GRUNDIG.DE/KUNDENDIENST
0050.000				PROGRAMM FLASH-EPROM <b>INTERNATIONAL</b> DOWNLOAD: WWW.GRUNDIG.DE/ PRODUKTE/KONTAKT/HAENDLERSERVICE	PROGRAM FLASH EPROM <b>INTERNATIONAL</b> DOWNLOAD: WWW.GRUNDIG.DE/ PRODUCTS/CONTACT/RESELLER SUPPORT
0201.000		191260466101	2	LAUTSPRECHER KOMBI	SPEAKER COMBI
0218.000		295018080101		NETZTASTENKNOPF DRUCK KPL	POWER KEY KNOB PRINT CPL
0226.000		295017440103		LAGERSTUECK	BEARING
0312.000		297006510103		ABDECKUNG DIGI-100	COVER DIGI-100
0315.000		191441179700		LAUTSPRECHER TIEFTON	SUBWOOFER
0320.000		291105366701		TYPENAUFKLEBER VNR	TYPE LABEL SELF ADHESIVE VNR
0950.000		292104087306		SHIFTSTECKER KPL 4W/330 OHM	SHIFT PLUG CPL 4W/330 OHM
0950.000		292104087606		SHIFTSTECKER KPL 5W/180 OHM	SHIFT PLUG CPL 5W/180 OHM
		293050176600		LED-PLATTE KEIN E-TEIL	DIODES BOARD NO SPARE PART
		219149411001		BEDIENUNGSANLEITUNG D	OPERATION INSTRUCTIONS D
		219149411101		BEDIENUNGSANLEITUNG F/I	OPERATION INSTRUCTIONS F/I
		219149411201		BEDIENUNGSANLEITUNG GB/NL	OPERATION INSTRUCTIONS GB/NL
		219149411301		BEDIENUNGSANLEITUNG E/P	OPERATION INSTRUCTIONS E/P
		219149411401		BEDIENUNGSANLEITUNG DK/FIN	OPERATION INSTRUCTIONS DK/FIN
		219149411501		BEDIENUNGSANLEITUNG S/N	OPERATION INSTRUCTIONS S/N
		720100305000		SERVICE MANUAL D/GB	SERVICE MANUAL D/GB
		720100305400		SERVICE MANUAL D/GB 4.ERGAENZUNG	SERVICE MANUAL D/GB 4TH SUPPLEMENT
		720100305500		SERVICE MANUAL D/GB 5.ERGAENZUNG	SERVICE MANUAL D/GB 5TH SUPPLEMENT
		720100305600		SERVICE MANUAL D/GB 6.ERGAENZUNG	SERVICE MANUAL D/GB 6TH SUPPLEMENT
		297040193300	X	CHASSIS-FS-STEREO DIGI 100 CUC 1935 KEIN E-TEIL	CHASSIS TV STEREO DIGI 100 CUC 1935 NO SPARE PART
				X = SIEHE GESONDERTE E-LISTE	X = SEE SEPARATE PARTS LIST
				ALLE ANDEREN TEILE SIEHE E-LISTE XENTIA 82 FLAT MFW 82-430/8 DOLBY PROCON SILBER MAT.-NR: 921914024000 BESTELL-NR: GCK9577 AUSGABE 4/2001 VERSION-NR.: VNM	FOR ALL OTHER PARTS SEE XENTIA 82 FLAT MFW 82-430/8 DOLBY PROCON SILBER PART NO: 921914024000 ORDER NO: GCK9577 EDITION 4/2001 VERSION NO.: VNM

ÄNDERUNGEN VORBEHALTEN / SUBJECT TO ALTERATION

POS. NR. MATERIAL-NR. BEZEICHNUNG  
POS. NO. PART NUMBER DESCRIPTION

POS. NR. MATERIAL-NR. BEZEICHNUNG  
POS. NO. PART NUMBER DESCRIPTION

### XENTIA 82 FLAT MFW 82-430/8 DOLBY

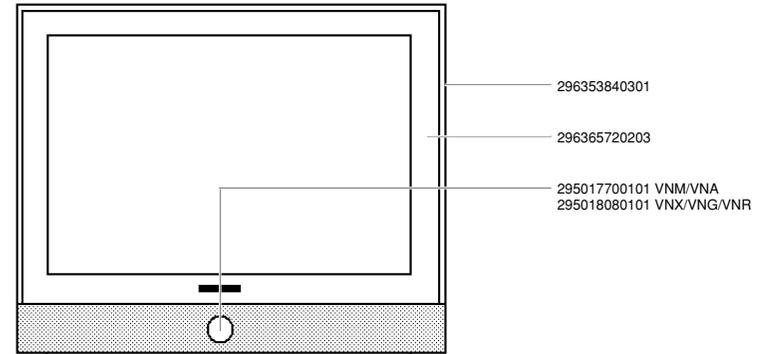

Es gelten die Vorschriften und Sicherheitshinweise gemäß dem Service Manual "Sicherheit", Mat.-Nummer 720108000000, sowie zusätzlich die eventuell abweichenden, landesspezifischen Vorschriften!



The regulations and safety instructions shall be valid as provided by the "Safety" Service Manual, part number 720108000000, as well as the respective national deviations.

ÄNDERUNGEN VORBEHALTEN / SUBJECT TO ALTERATION

### Ersatzteilliste Spare Parts List

8 / 2002

### XENTIA 82 FLAT MFW 82-430/8 DOLBY

MATERIAL-NR. / PART NO.: 921914024000 BESTELL-NR. / ORDER NO.: GCK9577 PROCON SILBER/PROCON SILBER  
VERSION NR./VERSION NO.: VNU

POS. NR. POS. NO.	ABB. FIG.	MATERIAL-NR. PART NUMBER	ANZ. QTY.	BEZEICHNUNG (D)	DESCRIPTION (GB)
		921914024000		XENTIA 82 FLAT MFW 82-430/8 DOLBY PROCON SILBER KEIN E-TEIL	XENTIA 82 FLAT MFW 82-430/8 DOLBY PROCON SILBER NO SPARE PART
0050.000				PROGRAMM FLASH-EPROM <b>DEUTSCHLAND</b> DOWNLOAD: HTTP://PARTNERWEB. GRUNDIG.DE/KUNDENDIENST	PROGRAM FLASH EPROM <b>GERMANY</b> DOWNLOAD: HTTP://PARTNERWEB. GRUNDIG.DE/KUNDENDIENST
0050.000				PROGRAMM FLASH-EPROM <b>INTERNATIONAL</b> DOWNLOAD: WWW.GRUNDIG.DE/ PRODUKTE/KONTAKT/HAENDLERSERVICE	PROGRAM FLASH EPROM <b>INTERNATIONAL</b> DOWNLOAD: WWW.GRUNDIG.DE/ PRODUCTS/CONTACT/RESELLER SUPPORT
0201.000		191260466101	2	LAUTSPRECHER KOMBI	SPEAKER COMBI
0218.000		295018080101		NETZTASTENKNOPF DRUCK KPL	POWER KEY KNOB PRINT CPL
0226.000		295017440103		LAGERSTUECK	BEARING
0312.000		297006510103		ABDECKUNG DIGI-100	COVER DIGI-100
0315.000		191441179700		LAUTSPRECHER TIEFTON	SUBWOOFER
0320.000		291105366801		TYPENAUFKLEBER VNU	TYPE LABEL SELF ADHESIVE VNU
0950.000		292104087306		SHIFTSTECKER KPL 4W/330 OHM	SHIFT PLUG CPL 4W/330 OHM
0950.000		292104087606		SHIFTSTECKER KPL 5W/180 OHM	SHIFT PLUG CPL 5W/180 OHM
1100.000		830006634200		BILDROHR W 76 ERF342X044 PHILIPS	PICTURE TUBE W 76 ERF342X044 PHILIPS
		293050176600		LED-PLATTE KEIN E-TEIL	DIODES BOARD NO SPARE PART
		219149411001		BEDIENUNGSANLEITUNG D	OPERATION INSTRUCTIONS D
		219149411101		BEDIENUNGSANLEITUNG F/I	OPERATION INSTRUCTIONS F/I
		219149411201		BEDIENUNGSANLEITUNG GB/NL	OPERATION INSTRUCTIONS GB/NL
		219149411301		BEDIENUNGSANLEITUNG E/P	OPERATION INSTRUCTIONS E/P
		219149411401		BEDIENUNGSANLEITUNG DK/FIN	OPERATION INSTRUCTIONS DK/FIN
		219149411501		BEDIENUNGSANLEITUNG S/N	OPERATION INSTRUCTIONS S/N
		720100305000		SERVICE MANUAL D/GB	SERVICE MANUAL D/GB
		720100305400		SERVICE MANUAL D/GB 4.ERGAENZUNG	SERVICE MANUAL D/GB 4TH SUPPLEMENT
		720100305500		SERVICE MANUAL D/GB 5.ERGAENZUNG	SERVICE MANUAL D/GB 5TH SUPPLEMENT
		720100305600		SERVICE MANUAL D/GB 6.ERGAENZUNG	SERVICE MANUAL D/GB 6TH SUPPLEMENT
		297040196300	X	CHASSIS-FS-STEREO DIGI 100 CUC 1935 KEIN E-TEIL	CHASSIS TV STEREO DIGI 100 CUC 1935 NO SPARE PART
				X = SIEHE GESONDERTE E-LISTE	X = SEE SEPARATE PARTS LIST
				ALLE ANDEREN TEILE SIEHE E-LISTE XENTIA 82 FLAT MFW 82-430/8 DOLBY PROCON SILBER MAT.-NR: 921914024000 BESTELL-NR: GCK9577 AUSGABE 4/2001 VERSION-NR.: VNM	FOR ALL OTHER PARTS SEE XENTIA 82 FLAT MFW 82-430/8 DOLBY PROCON SILBER PART NO: 921914024000 ORDER NO: GCK9577 EDITION 4/2001 VERSION NO.: VNM

ÄNDERUNGEN VORBEHALTEN / SUBJECT TO ALTERATION

POS. NR. MATERIAL-NR. BEZEICHNUNG  
POS. NO. PART NUMBER DESCRIPTION

POS. NR. MATERIAL-NR. BEZEICHNUNG  
POS. NO. PART NUMBER DESCRIPTION

### XENTIA 82 FLAT MFW 82-430/8 DOLBY

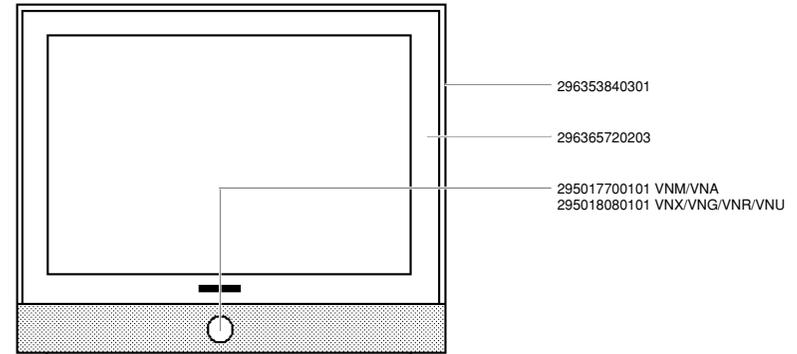

Es gelten die Vorschriften und Sicherheitshinweise gemäß dem Service Manual "Sicherheit", Mat.-Nummer 720108000000, sowie zusätzlich die eventuell abweichenden, landesspezifischen Vorschriften!



The regulations and safety instructions shall be valid as provided by the "Safety" Service Manual, part number 720108000000, as well as the respective national deviations.

ÄNDERUNGEN VORBEHALTEN / SUBJECT TO ALTERATION

### Ersatzteilliste Spare Parts List

8 / 2002

### XENTIA 82 FLAT MFW 82-430/8 DOLBY

MATERIAL-NR. / PART NO.: 921914024000 BESTELL-NR. / ORDER NO.: GCK9577 PROCON SILBER/PROCON SILBER  
VERSION NR./VERSION NO.: VNM

POS. NR. POS. NO.	ABB. FIG.	MATERIAL-NR. PART NUMBER	ANZ. QTY.	BEZEICHNUNG (D)	DESCRIPTION (GB)
		921914024000		XENTIA 82 FLAT MFW 82-430/8 DOLBY PROCON SILBER KEIN E-TEIL	XENTIA 82 FLAT MFW 82-430/8 DOLBY PROCON SILBER NO SPARE PART
0050.000				PROGRAMM FLASH-EPROM <b>DEUTSCHLAND</b> DOWNLOAD: HTTP://PARTNERWEB. GRUNDIG.DE/KUNDENDIENST PROGRAMM FLASH-EPROM <b>INTERNATIONAL</b> DOWNLOAD: WWW.GRUNDIG.DE/ PRODUKTE/KONTAKT/HAENDLERSERVICE	PROGRAM FLASH EPROM <b>GERMANY</b> DOWNLOAD: HTTP://PARTNERWEB. GRUNDIG.DE/KUNDENDIENST PROGRAM FLASH EPROM <b>INTERNATIONAL</b> DOWNLOAD: WWW.GRUNDIG.DE/ PRODUCTS/CONTACT/RESELLER SUPPORT
0201.000		191260529701	2	LS-KOMBI M.GUMMIPUFFER	SPEAKER COMBI W.RUBBER BUFFER
0218.000		295018080101		NETZTASTENKNOPF DRUCK KPL	POWER KEY KNOB PRINT CPL
0226.000		295017440103		LAGERSTUECK	BEARING
0312.000		297006510401		ABDECKUNG DIGI-100/3EURO-AV	COVER DIGI-100/3EURO-AV
0315.000		191441179700		LAUTSPRECHER TIEFTON	SUBWOOFER
0320.000		291105736902		TYPENAUFKLEBER VNN	TYPE LABEL SELF ADHESIVE VNNL
0950.000		292104087606		SHIFTSTECKER KPL 5W/180 OHM	SHIFT PLUG CPL 5W/180 OHM
0950.000		292104087306		SHIFTSTECKER KPL 4W/330 OHM	SHIFT PLUG CPL 4W/330 OHM
1100.000		830007636000		BILDROHR W 76 LTL350X97(U) TOSHIBA	PICTURE TUBE W 76 LTL350X97(U) TOSHIBA
1110.000		292013601602		ANODENKAPPE M.HOCHSPANNUNGSKABEL	ANODE CAP WITH HIGH VOLTAGE CABLE
2300.000		293051223200	X	BILDROHRPLATTE DIGI 100	PICTURE TUBE BOARD DIGI 100
		293050176600		LED-PLATTE KEIN E-TEIL	DIODES BOARD NO SPARE PART
		219149411700		BEDIENUNGSANLEITUNG D	OPERATION INSTRUCTIONS D
		219149411800		BEDIENUNGSANLEITUNG F/I	OPERATION INSTRUCTIONS F/I
		219149411900		BEDIENUNGSANLEITUNG GB/NL	OPERATION INSTRUCTIONS GB/NL
		219149412000		BEDIENUNGSANLEITUNG E/P	OPERATION INSTRUCTIONS E/P
		219149412100		BEDIENUNGSANLEITUNG DK/FIN	OPERATION INSTRUCTIONS DK/FIN
		219149412200		BEDIENUNGSANLEITUNG S/N	OPERATION INSTRUCTIONS S/N
		720100305000		SERVICE MANUAL D/GB	SERVICE MANUAL D/GB
		720100305400		SERVICE MANUAL D/GB 4. ERGAENZUNG	SERVICE MANUAL D/GB 4TH SUPPLEMENT
		720100305500		SERVICE MANUAL D/GB 5. ERGAENZUNG	SERVICE MANUAL D/GB 5TH SUPPLEMENT
		720100305600		SERVICE MANUAL D/GB 6. ERGAENZUNG	SERVICE MANUAL D/GB 6TH SUPPLEMENT
		297040197900	X	CHASSIS-FS-STEREO DIGI 100 CUC 1935 KEIN E-TEIL	CHASSIS TV STEREO DIGI 100 CUC 1935 NO SPARE PART
				X = SIEHE GESONDERTE E-LISTE	X = SEE SEPARATE PARTS LIST
				ALLE ANDEREN TEILE SIEHE E-LISTE XENTIA 82 FLAT MFW 82-430/8 DOLBY PROCON SILBER MAT.-NR: 921914024000 BESTELL-NR: GCK9577 AUSGABE 4/2001 VERSION-NR.: VNM	FOR ALL OTHER PARTS SEE XENTIA 82 FLAT MFW 82-430/8 DOLBY PROCON SILBER PART NO: 921914024000 ORDER NO: GCK9577 EDITION 4/2001 VERSION NO.: VNM

ÄNDERUNGEN VORBEHALTEN / SUBJECT TO ALTERATION

POS. NR. MATERIAL-NR. BEZEICHNUNG  
POS. NO. PART NUMBER DESCRIPTION

POS. NR. MATERIAL-NR. BEZEICHNUNG  
POS. NO. PART NUMBER DESCRIPTION

### XENTIA 82 FLAT MFW 82-430/8 DOLBY

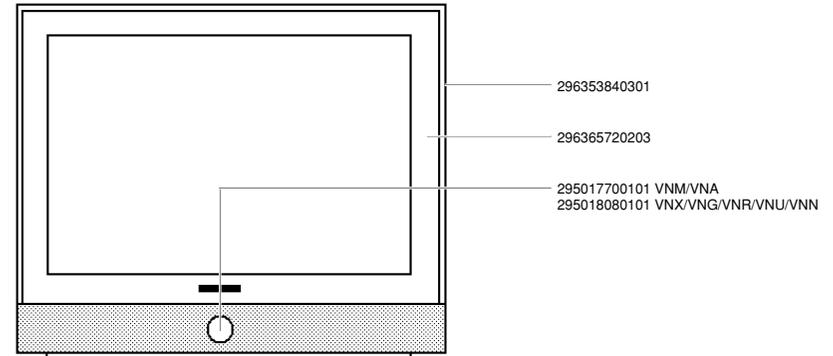

Es gelten die Vorschriften und Sicherheitshinweise gemäß dem Service Manual "Sicherheit", Mat.-Nummer 720108000000, sowie zusätzlich die eventuell abweichenden, landesspezifischen Vorschriften!



The regulations and safety instructions shall be valid as provided by the "Safety" Service Manual, part number 720108000000, as well as the respective national deviations.

ÄNDERUNGEN VORBEHALTEN / SUBJECT TO ALTERATION

MATERIAL-NR. / PART NO.: 922208029200 BESTELL-NR. / ORDER NO.: GCM5900 TITANE  
VERSION NR./VERSION NO.: VNA

POS. NR. POS. NO.	ABB. FIG.	MATERIAL-NR. PART NUMBER	ANZ. QTY.	BEZEICHNUNG (D)	DESCRIPTION (GB)
		922208029200		ARGANTO 82 MW 82-515 MV/DOLBY TITANE KEIN E-TEIL	ARGANTO 82 MW 82-515 MV/DOLBY TITANE NO SPARE PART
0050.000				PROGRAMM FLASH-EPROM <b>DEUTSCHLAND</b> DOWNLOAD: HTTP://PARTNERWEB. GRUNDIG.DE/KUNDENDIENST	PROGRAM FLASH EPROM <b>GERMANY</b> DOWNLOAD: HTTP://PARTNERWEB. GRUNDIG.DE/KUNDENDIENST
0050.000				PROGRAMM FLASH-EPROM <b>INTERNATIONAL</b> DOWNLOAD: WWW.GRUNDIG.DE/ PRODUKTE/KONTAKT/HAENDLERSERVICE	PROGRAM FLASH EPROM <b>INTERNATIONAL</b> DOWNLOAD: WWW.GRUNDIG.DE/ PRODUCTS/CONTACT/RESELLER SUPPORT
0213.000		296381380402	2	ABDECKUNG OFB	COVER SURFACE TREATED
0231.000		296383380101	2	ISOLIERFOLIE	INSULATING FOIL
0312.000		297006510104		ABDECKUNG DIGI-100	COVER DIGI-100
0313.000		296364568703		ABDECKUNG	COVER
0315.000		191540310300		LAUTSPRECHER TIEFTON	LOUDSPEAKER WOOFER
0320.000		291105356401		TYPENAUFKLEBER VNA	TYPE LABEL SELF ADHESIVE VNA
0900.000	△	292014771102		FOKUS U.UG2-REGLER	FOCUS AND UG2-CONTROLLER
0940.000		297006542101		HALTER FOKUSBLOCK	HOLDER FOCUS UNIT
0950.000		292104087306		SHIFTSTECKER KPL 4W/330 OHM	SHIFT PLUG CPL 4W/330 OHM
0950.000		292104087606		SHIFTSTECKER KPL 5W/180 OHM	SHIFT PLUG CPL 5W/180 OHM
1100.000		830007623000		BILDROHR W 76 ESF031X44 PHILIPS	PICTURE TUBE W 76 ESF031X44 PHILIPS
1302.000		293033751002		SCHENKELFEDER	LEG SPRING
1352.000		296367010303		KLAPPE DRUCK KPL	FLAP PRINT CPL
		222089410200		BEDIENUNGSANLEITUNG D	OPERATION INSTRUCTIONS D
		222089410300		BEDIENUNGSANLEITUNG F/I	OPERATION INSTRUCTIONS F/I
		222089410500		BEDIENUNGSANLEITUNG E/P	OPERATION INSTRUCTIONS E/P
		222089410600		BEDIENUNGSANLEITUNG DK/FIN	OPERATION INSTRUCTIONS DK/FIN
		222089410700		BEDIENUNGSANLEITUNG S/N	OPERATION INSTRUCTIONS S/N
		720100305000		SERVICE MANUAL D/GB	SERVICE MANUAL D/GB
		720100305400		SERVICE MANUAL D/GB 4. ERGAENZUNG	SERVICE MANUAL D/GB 4TH SUPPLEMENT
		720100305500		SERVICE MANUAL D/GB 5. ERGAENZUNG	SERVICE MANUAL D/GB 5TH SUPPLEMENT
		720100305600		SERVICE MANUAL D/GB 6. ERGAENZUNG	SERVICE MANUAL D/GB 6TH SUPPLEMENT
		297040190700	X	CHASSIS-FS-STEREO DIGI 100 CUC 1935 KEIN E-TEIL	CHASSIS TV STEREO DIGI 100 CUC 1935 NO SPARE PART
				X = SIEHE GESONDERTE E-LISTE	X = SEE SEPARATE PARTS LIST
				ALLE WEITEREN TEILE SIEHE E-LISTE ARGANTO 82 MW 82-515 MV/DOLBY MAT.-NR.: 922208029200 BESTELL-NR.: GCM5900 AUSGABE ????? VERSION NR.: VNM	FOR ALL OTHER PARTS SEE ARGANTO 82 MW 82-515 MV/DOLBY PART NO.: 922208029200 ORDER NO.: GCM5900 EDITION VERSION NO.: VNM

MATERIAL-NR. / PART NO.: 921962024000 BESTELL-NR. / ORDER NO.: GCL8540 PROCON SILBER/PROCON SILVER  
VERSION NR./VERSION NO.: VNA

POS. NR. POS. NO.	ABB. FIG.	MATERIAL-NR. PART NUMBER	ANZ. QTY.	BEZEICHNUNG (D)	DESCRIPTION (GB)
		921962024000		ELEGANCE 82 FLAT MFW 82-3110 MV/DOLBY PROCON SILBER KEIN E-TEIL	ELEGANCE 82 FLAT MFW 82-3110 MV/DOLBY PROCON SILVER NO SPARE PART
0050.000				PROGRAMM FLASH-EPROM <b>DEUTSCHLAND</b> DOWNLOAD: HTTP://PARTNERWEB. GRUNDIG.DE/KUNDENDIENST	PROGRAM FLASH EPROM <b>GERMANY</b> DOWNLOAD: HTTP://PARTNERWEB. GRUNDIG.DE/KUNDENDIENST
0050.000				PROGRAMM FLASH-EPROM <b>INTERNATIONAL</b> DOWNLOAD: WWW.GRUNDIG.DE/ PRODUKTE/KONTAKT/HAENDLERSERVICE	PROGRAM FLASH EPROM <b>INTERNATIONAL</b> DOWNLOAD: WWW.GRUNDIG.DE/ PRODUCTS/CONTACT/RESELLER SUPPORT
0201.000		191260459700	2	LS-KOMBI	LOUDSPEAKER
0207.000		296367220101		SCHALLWAND RECHTS M.VLIES	BAFFLE RHS W.FLEECE CPL
0207.000		296367230101		SCHALLWAND LINKS M.VLIES	BAFFLE LHS W.FLEECE CPL
0210.000		295017610104		BEDIENEINSATZ MONTIERT KPL	CONTROL INSERT MOUNTED CPL
0225.000		295017623102		KLAPPE DRUCK KPL BEDIENEINSATZ	FLAP PRINT CPL CONTROL INSERT
0240.000		293033904200		KOPFHÖRERBUCHSE 3,5mm O.SCHALTER	HEADPHONE SOCKET 3.5mm W/O SWITCH
0241.000		293031680503		CINCH-BUCHSE 3-FACH FBAS/NF L,R	CINCH SOCKET 3-FOLD FBAS/AF L,R
0300.000		296366030301		GEH-RUECKTEIL OFB	CABINET REAR PART SURFACE TREATED
0312.000		297006510103		ABDECKUNG DIGI-100	COVER DIGI-100
0320.000		291105196401		TYPENAUFKLEBER VNA	TYPE LABEL SELF ADHESIVE VNA
0450.000		297006542101		HALTER FOKUSBLOCK	HOLDER FOCUS UNIT
0950.000		292104087306		SHIFTSTECKER KPL 4W/330 OHM	SHIFT PLUG CPL 4W/330 OHM
0950.000		292104087606		SHIFTSTECKER KPL 5W/180 OHM	SHIFT PLUG CPL 5W/180 OHM
2410.000		720086731000		DECKEL BATTERIE	BATTERY LID
		219639410200		BEDIENUNGSANLEITUNG D	OPERATION INSTRUCTIONS D
		219639410300		BEDIENUNGSANLEITUNG F/I	OPERATION INSTRUCTIONS F/I
		219639410400		BEDIENUNGSANLEITUNG GB/NL	OPERATION INSTRUCTIONS GB/NL
		219639410500		BEDIENUNGSANLEITUNG E/P	OPERATION INSTRUCTIONS E/P
		219639410600		BEDIENUNGSANLEITUNG DK/FIN	OPERATION INSTRUCTIONS DK/FIN
		219639410700		BEDIENUNGSANLEITUNG S/N	OPERATION INSTRUCTIONS S/N
		720100305000		SERVICE MANUAL D/GB	SERVICE MANUAL D/GB
		720100305400		SERVICE MANUAL D/GB 4. ERGAENZUNG	SERVICE MANUAL D/GB 4TH SUPPLEMENT
		720100305500		SERVICE MANUAL D/GB 5. ERGAENZUNG	SERVICE MANUAL D/GB 5TH SUPPLEMENT
		720100305600		SERVICE MANUAL D/GB 6. ERGAENZUNG	SERVICE MANUAL D/GB 6TH SUPPLEMENT
		297040191200	X	CHASSIS-FS-STEREO DIGI 100 CUC 1935 KEIN E-TEIL	CHASSIS TV STEREO DIGI 100 CUC 1935 NO SPARE PART
				X = SIEHE GESONDERTE E-LISTE	X = SEE SEPARATE PARTS LIST
				ALLE ANDEREN TEILE SIEHE E-LISTE ELEGANCE 82 MFW 82-3110 MV/DOLBY MAT.-NR.: 921962024000 BESTELL-NR.: GCL8540 AUSGABE 11/2000 VERSION-NR.: VNM	FOR ALL OTHER PARTS SEE ELEGANCE 82 MFW 82-3110 MV/DOLBY PART NO.: 921962024000 ORDER NO.: GCL8540 EDITION 11/2000 VERSION NO.: VNM

Es gelten die Vorschriften und Sicherheitshinweise gemäß dem Service Manual "Sicherheit", Mat.-Nummer 720108000000, sowie zusätzlich die eventuell abweichenden, landesspezifischen Vorschriften!



The regulations and safety instructions shall be valid as provided by the "Safety" Service Manual, part number 720108000000, as well as the respective national deviations.

ÄNDERUNGEN VORBEHALTEN / SUBJECT TO ALTERATION

ÄNDERUNGEN VORBEHALTEN / SUBJECT TO ALTERATION

POS. NR. MATERIAL-NR. BEZEICHNUNG  
 POS. NO. PART NUMBER DESCRIPTION

POS. NR. MATERIAL-NR. BEZEICHNUNG  
 POS. NO. PART NUMBER DESCRIPTION

**ELEGANCE 82 MFW 82-3110 MV/DOLBY**

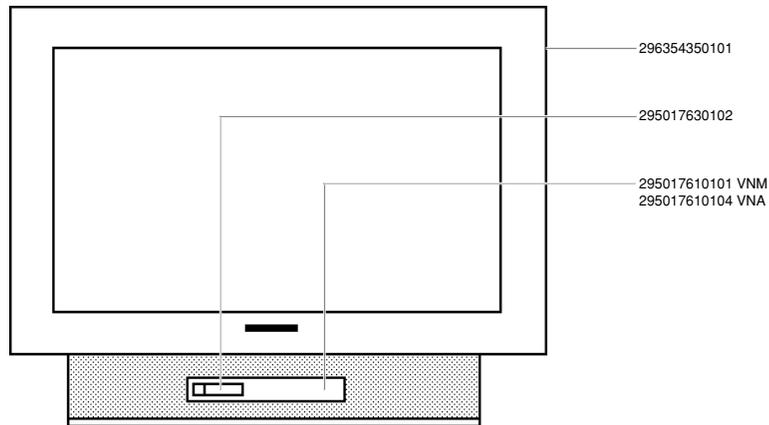

107

**Ersatzteilliste  
 Spare Parts List**

**7 / 2002**

**ELEGANCE 82 FLAT MFW 82-3110 MV/DOLBY**

MATERIAL-NR. / PART NO.: 921962024000 BESTELL-NR. / ORDER NO.: GCL8540 PROCON SILBER/PROCON SILVER  
 VERSION NR./VERSION NO.: VNX

POS. NR. POS. NO.	ABB. FIG.	MATERIAL-NR. PART NUMBER	ANZ. QTY.	BEZEICHNUNG (D)	DESCRIPTION (GB)
		921962024000		ELEGANCE 82 MFW 82-3110 MV/DOLBY PROCON SILBER KEIN E-TEIL	ELEGANCE 82 MFW 82-3110 MV/DOLBY PROCON SILVER NO SPARE PART
0050.000				PROGRAMM FLASH-EPROM <b>DEUTSCHLAND</b> DOWNLOAD: HTTP://PARTNERWEB. GRUNDIG.DE/KUNDENDIENST PROGRAMM FLASH-EPROM <b>INTERNATIONAL</b> DOWNLOAD: WWW.GRUNDIG.DE/ PRODUKTE/KONTAKT/HAENDLERSERVICE	PROGRAM FLASH EPROM <b>GERMANY</b> DOWNLOAD: HTTP://PARTNERWEB. GRUNDIG.DE/KUNDENDIENST PROGRAM FLASH EPROM <b>INTERNATIONAL</b> DOWNLOAD: WWW.GRUNDIG.DE/ PRODUCTS/CONTACT/RESELLER SUPPORT
0201.000		191260459700	2	LS-KOMBI	LOUDSPEAKER
0207.000		296367220101		SCHALLWAND RECHTS M.VLIES	BAFFLE RHS W.FLEECE CPL
0207.000		296367230101		SCHALLWAND LINKS M.VLIES	BAFFLE LHS W.FLEECE CPL
0210.000		295017610104		BEDIENEINSATZ MONTIERT KPL	CONTROL INSERT MOUNTED CPL
0225.000		295017623102		KLAPPE DRUCK KPL BEDIENEINSATZ	FLAP PRINT CPL CONTROL INSERT
0312.000		297006510103		ABDECKUNG DIGI-100	COVER DIGI-100
0300.000		296366030301		GEH-RUECKTEIL OFB	CABINET REAR PART SURFACE TREATED
0320.000		291105196501		TYPENAUFKLEBER VNX	TYPE LABEL SELF ADHESIVE VNX
0240.000		293033904200		KOPFHOERERBUCHSE 3,5mm O.SCHALTER	HEADPHONE SOCKET 3.5mm W/O SWITCH
0241.000		293031680503		CINCH-BUCHSE 3-FACH FBAS/NF L,R	CINCH SOCKET 3 FOLD FBAS/AF L,R
0450.000		297006542101		HALTER FOKUSBLOCK	HOLDER FOCUS UNIT
0950.000		292104087606		SHIFTSTECKER KPL 5W/180 OHM	SHIFT PLUG CPL 5W/180 OHM
0950.000		292104087306		SHIFTSTECKER KPL 4W/330 OHM	SHIFT PLUG CPL 4W/330 OHM
1100.000		830006634200		BILDROHR W 76 ERF342X044 PHILIPS	PICTURE TUBE W 76 ERF342X044 PHILIPS
2410.000		720086731000		DECKEL BATTERIE	BATTERY LID
		219639410200		BEDIENUNGSANLEITUNG D	OPERATION INSTRUCTIONS D
		219629410300		BEDIENUNGSANLEITUNG FR/I	OPERATION INSTRUCTIONS FR/I
		219639410400		BEDIENUNGSANLEITUNG GB/NL	OPERATION INSTRUCTIONS GB/NL
		219629410500		BEDIENUNGSANLEITUNG E/P	OPERATION INSTRUCTIONS E/P
		219639410600		BEDIENUNGSANLEITUNG DK/FIN	OPERATION INSTRUCTIONS DK/FIN
		219629410700		BEDIENUNGSANLEITUNG S/N	OPERATION INSTRUCTIONS S/N
		720100305000		SERVICE MANUAL D/GB	SERVICE MANUAL D/GB
		720100305400		SERVICE MANUAL D/GB 4. ERGAENZUNG	SERVICE MANUAL D/GB 4TH SUPPLEMENT
		720100305500		SERVICE MANUAL D/GB 5. ERGAENZUNG	SERVICE MANUAL D/GB 5TH SUPPLEMENT
		720100305600		SERVICE MANUAL D/GB 6. ERGAENZUNG	SERVICE MANUAL D/GB 6TH SUPPLEMENT
		297040196200	X	CHASSIS-FS-STEREO DIGI 100 CUC 1935 KEIN E-TEIL	CHASSIS TV STEREO DIGI 100 CUC 1935 NO SPARE PART
				X = SIEHE GESONDERTE E-LISTE	X = SEE SEPARATE PARTS LIST
				ALLE ANDEREN TEILE SIEHE E-LISTE ELEGANCE 82 MFW 82-3110 MV/DOLBY MAT.-NR: 921962024000 BESTELL-NR: GCL8540 AUSGABE 11/2000 VERSION-NR.: VNM	FOR ALL OTHER PARTS SEE ELEGANCE 82 MFW 82-3110 MV/DOLBY PART NO: 921962024000 ORDER NO: GCL8540 EDITION 11/2000 VERSION NO.: VNM

Es gelten die Vorschriften und Sicherheitshinweise gemäß dem Service Manual "Sicherheit", Mat.-Nummer 720108000000, sowie zusätzlich die eventuell abweichenden, landesspezifischen Vorschriften!



The regulations and safety instructions shall be valid as provided by the "Safety" Service Manual, part number 720108000000, as well as the respective national deviations.

ÄNDERUNGEN VORBEHALTEN / SUBJECT TO ALTERATION

ÄNDERUNGEN VORBEHALTEN / SUBJECT TO ALTERATION

POS. NR. MATERIAL-NR. BEZEICHNUNG  
POS. NO. PART NUMBER DESCRIPTION

POS. NR. MATERIAL-NR. BEZEICHNUNG  
POS. NO. PART NUMBER DESCRIPTION

**ELEGANCE 82 MFW 82-3110 MV/DOLBY**

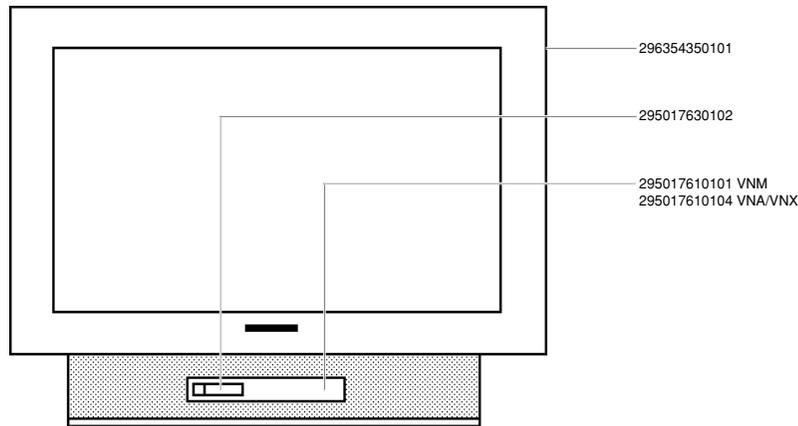

108

**Ersatzteilliste  
Spare Parts List**

**7 / 2002**

**ELEGANCE 82 FLAT MFW 82-3110 MV/DOLBY**

MATERIAL-NR. / PART NO.: 921962024000 BESTELL-NR. / ORDER NO.: GCL8540 PROCON SILBER/PROCON SILVER  
VERSION NR./VERSION NO.: VNG

POS. NR. POS. NO.	ABB. FIG.	MATERIAL-NR. PART NUMBER	ANZ. QTY.	BEZEICHNUNG (D)	DESCRIPTION (GB)
		921962024000		ELEGANCE 82 MFW 82-3110 MV/DOLBY PROCON SILBER KEIN E-TEIL	ELEGANCE 82 MFW 82-3110 MV/DOLBY PROCON SILVER NO SPARE PART
0050.000				PROGRAMM FLASH-EPROM <b>DEUTSCHLAND</b> DOWNLOAD: HTTP://PARTNERWEB. GRUNDIG.DE/KUNDENDIENST PROGRAMM FLASH-EPROM <b>INTERNATIONAL</b> DOWNLOAD: WWW.GRUNDIG.DE/ PRODUKTE/KONTAKT/HAENDLERSERVICE	PROGRAM FLASH EPROM <b>GERMANY</b> DOWNLOAD: HTTP://PARTNERWEB. GRUNDIG.DE/KUNDENDIENST PROGRAM FLASH EPROM <b>INTERNATIONAL</b> DOWNLOAD: WWW.GRUNDIG.DE/ PRODUCTS/CONTACT/RESELLER SUPPORT
0201.000		191260459700	2	LS-KOMBI	LOUDSPEAKER COMBI
0207.000		296367220101		SCHALLWAND RECHTS M.VLIES	BAFFLE RHS W.FLEECE CPL
0207.000		296367230101		SCHALLWAND LINKS M.VLIES	BAFFLE LHS W.FLEECE CPL
0210.000		295017610104		BEDIENEINSATZ MONTIERT KPL	CONTROL INSERT MOUNTED CPL
0225.000		295017623102		KLAPPE DRUCK KPL BEDIENEINSATZ	FLAP PRINT CPL CONTROL INSERT
0240.000		293033904200		KOPFHOERERBUCHSE 3,5mm O.SCHALTER	HEADPHONE SOCKET 3.5mm W/O SWITCH
0241.000		293031680503		CINCH-BUCHSE 3-FACH FBAS/NF L,R	CINCH SOCKET 3 FOLD FBAS/AF L,R
0300.000		296366030301		GEH-RUECKTEIL OFB	CABINET REAR PART SURFACE TREATED
0312.000		297006510103		ABDECKUNG DIGI-100	COVER DIGI-100
0320.000		291105676601		TYPENAUFKLEBER VNG	TYPE LABEL SELF ADHESIVE VNG
0450.000		297006542101		HALTER FOKUSBLOCK	HOLDER FOCUS UNIT
0950.000		292104087606		SHIFTSTECKER KPL 5W/180 OHM	SHIFT PLUG CPL 5W/180 OHM
0950.000		292104087306		SHIFTSTECKER KPL 4W/330 OHM	SHIFT PLUG CPL 4W/330 OHM
1100.000		830007636000		BILDROHR W 76 LTL350X97 TOSHIBA	PICTURE TUBE W 76 LTL350X97 TOSHIBA
1200.000	△	292013601602		ANODENKAPPE M.HOCHSPANNUNGSKABEL	ANODE CAP W.HIGH VOLTAGE CABLE
2300.000		293051223200	X	BILDROHRPLATTE	PICTURE TUBE BOARD
2410.000		720086731000		DECKEL BATTERIE	BATTERY LID
		219629410900		BEDIENUNGSANLEITUNG D	OPERATION INSTRUCTIONS D
		219629411000		BEDIENUNGSANLEITUNG FR/I	OPERATION INSTRUCTIONS FR/I
		219629411100		BEDIENUNGSANLEITUNG GB/NL	OPERATION INSTRUCTIONS GB/NL
		219629411200		BEDIENUNGSANLEITUNG E/P	OPERATION INSTRUCTIONS E/P
		219629411300		BEDIENUNGSANLEITUNG DK/FIN	OPERATION INSTRUCTIONS DK/FIN
		219629411400		BEDIENUNGSANLEITUNG S/N	OPERATION INSTRUCTIONS S/N
		720100305000		SERVICE MANUAL D/GB	SERVICE MANUAL D/GB
		720100305400		SERVICE MANUAL D/GB 4. ERGAENZUNG	SERVICE MANUAL D/GB 4TH SUPPLEMENT
		720100305500		SERVICE MANUAL D/GB 5. ERGAENZUNG	SERVICE MANUAL D/GB 5TH SUPPLEMENT
		720100305600		SERVICE MANUAL D/GB 6. ERGAENZUNG	SERVICE MANUAL D/GB 6TH SUPPLEMENT
		297040196900	X	CHASSIS-FS-STEREO DIGI 100 CUC 1935 KEIN E-TEIL	CHASSIS TV STEREO DIGI 100 CUC 1935 NO SPARE PART
				X = SIEHE GESONDERTE E-LISTE WW. = WAHLWEISE	X = SEE SEPARATE PARTS LIST WW. = OPTIONAL
				ALLE ANDEREN TEILE SIEHE E-LISTE ELEGANCE 82 MFW 82-3110 MV/DOLBY MAT.-NR: 921962024000 BESTELL-NR: GCL8540 AUSGABE 11/2000 VERSION-NR.: VNM	FOR ALL OTHER PARTS SEE ELEGANCE 82 MFW 82-3110 MV/DOLBY PART NO: 921962024000 ORDER NO: GCL8540 EDITION 11/2000 VERSION NO.: VNM

Es gelten die Vorschriften und Sicherheitshinweise gemäß dem Service Manual "Sicherheit", Mat.-Nummer 720108000000, sowie zusätzlich die eventuell abweichenden, landesspezifischen Vorschriften!



The regulations and safety instructions shall be valid as provided by the "Safety" Service Manual, part number 720108000000, as well as the respective national deviations.

ÄNDERUNGEN VORBEHALTEN / SUBJECT TO ALTERATION

ÄNDERUNGEN VORBEHALTEN / SUBJECT TO ALTERATION

POS. NR. MATERIAL-NR. BEZEICHNUNG  
 POS. NO. PART NUMBER DESCRIPTION

POS. NR. MATERIAL-NR. BEZEICHNUNG  
 POS. NO. PART NUMBER DESCRIPTION

**ELEGANCE 82 MFW 82-3110 MV/DOLBY**

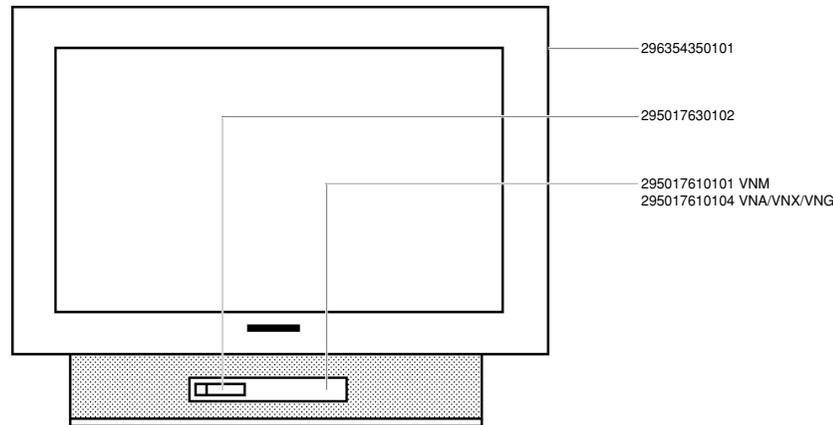

109

**Ersatzteilliste  
 Spare Parts List**

**7 / 2002**

**MW 82-3112 MV/DOLBY**

MATERIAL-NR. / PART NO.: 922217027500 BESTELL-NR. / ORDER NO.: GCM9800 SCHWARZ/BLACK  
 VERSION NR./VERSION NO.: VNA

POS. NR. ABB. POS. NO. FIG.	MATERIAL-NR. PART NUMBER	ANZ. QTY.	BEZEICHNUNG (D)	DESCRIPTION (GB)
	922217027500		MW 82-3112 MV/DOLBY SCHWARZ KEIN E-TEIL	MW 82-3112 MV/DOLBY BLACK NO SPARE PART
			PROGRAMM FLASH-EPROM DOWNLOAD: WWW.GRUNDIG.DE/ PRODUKTE/KONTAKT/HAENDLERSERVICE	PROGRAM FLASH EPROM DOWNLOAD: WWW.GRUNDIG.DE/ PRODUCTS/CONTACT/RESELLER SUPPORT
0229.000 0300.000 0320.000 0700.000	296322840101 296361780100 291105306403 092461547502		EMBLEM GRUNDIG GEH-RUECKTEIL OFB TYPENAUFKLEBER VNA ENTMAG.-ROTATIONSSPULEN SET M.HALTER KPL	EMBLEM GRUNDIG CABINET REAR PART SURFACE TYPE LABEL VNA DEGAUSSING ROTATING COIL SET W.HOLDER CP
0900.000 1100.000	292014771101 830007623000		FOKUS U.UG2-REGLER BILDR.W 76 ESF 031X44 PHILIPS	FOCUS AND UG2-CONTROLLER PICT.TUBE W 76 ESF 031X44 PHILIPS
	222179410200 222179410300 222179410400 222179410500 222179410600 222179410700 720100305000 720100305400 720100305500 720100305600		BEDIENUNGSANLEITUNG D BEDIENUNGSANLEITUNG F/I BEDIENUNGSANLEITUNG GB/NL BEDIENUNGSANLEITUNG E/P BEDIENUNGSANLEITUNG DK/FIN BEDIENUNGSANLEITUNG S/N SERVICE MANUAL D/GB SERVICE MANUAL D/GB 4.ERGAENZUNG SERVICE MANUAL D/GB 5.ERGAENZUNG SERVICE MANUAL D/GB 6.ERGAENZUNG	OPERATING INSTRUCTIONS D OPERATING INSTRUCTIONS F/I OPERATING INSTRUCTIONS GB/NL OPERATING INSTRUCTIONS E/P OPERATING INSTRUCTIONS DK/FIN OPERATING INSTRUCTIONS S/N SERVICE MANUAL D/GB SERVICE MANUAL D/GB 4TH SUPPLEMENT SERVICE MANUAL D/GB 5TH SUPPLEMENT SERVICE MANUAL D/GB 6TH SUPPLEMENT
	296560043301		MONTAGEZUBEHOER F.BILDROHR KEIN E-TEIL	MOUNTING ACCESSORIES F.PI NO SPARE PART
	297040192500	X	CHASSIS-FS-STEREO CUC 1935 DIGI 100 KEIN E-TEIL	CHASSIS TV STEREO CUC 1935 DIGI 100 NO SPARE PART
			ALLE WEITEREN TEILE SIEHE E-LISTE MW 82-3112 MV/DOLBY MAT.-NR:922217027500 BESTELL-NR.:GCM9800 AUSGABE 2/2001 VERSION NR.: VNM	FOR ALL ORTHER PARTS SEE MW 82-3112 MV/DOLBY PART NO:922217027500 ORDNER NO:GCM9800 EDITION 2/2001 VERSION NO.: VNM

Es gelten die Vorschriften und Sicherheitshinweise gemäß dem Service Manual "Sicherheit", Mat.-Nummer 720108000000, sowie zusätzlich die eventuell abweichenden, landesspezifischen Vorschriften!



The regulations and safety instructions shall be valid as provided by the "Safety" Service Manual, part number 720108000000, as well as the respective national deviations.

ÄNDERUNGEN VORBEHALTEN / SUBJECT TO ALTERATION

Es gelten die Vorschriften und Sicherheitshinweise gemäß dem Service Manual "Sicherheit", Mat.-Nummer 720108000000, sowie zusätzlich die eventuell abweichenden, landesspezifischen Vorschriften!



The regulations and safety instructions shall be valid as provided by the "Safety" Service Manual, part number 720108000000, as well as the respective national deviations.

ÄNDERUNGEN VORBEHALTEN / SUBJECT TO ALTERATION

## Ersatzteilliste Spare Parts List

### 6 / 2002

### MW 82-3112 MV/DOLBY

MATERIAL-NR. / PART NO.: 922217024000 BESTELL-NR. / ORDER NO.: GCM9810 PROCON-SILBER/PROCON SILVER  
VERSION NR./VERSION NO.: VNA

POS. NR. POS. NO.	ABB. FIG.	MATERIAL-NR. PART NUMBER	ANZ. QTY.	BEZEICHNUNG (D)	DESCRIPTION (GB)
		922217024000		MW 82-3112 MV/DOLBY PROCON-SILBER KEIN E-TEIL	MW 82-3112 MV/DOLBY PROCON SILVER NO SPARE PART
0050.000				PROGRAMM FLASH-EPROM DOWNLOAD: WWW.GRUNDIG.DE/ PRODUKTE/KONTAKT/HAENDLERSERVICE	PROGRAM FLASH EPROM DOWNLOAD: WWW.GRUNDIG.DE/ PRODUCTS/CONTACT/RESELLER SUPPORT
0200.000		296352110801		GEH-VORDETEIL DRUCK KPL	CABINET FRONT PART PRINT
0201.000		191180117200	2	LAUTSPRECHER	LOUDSPEAKER
0202.000		191150079700	2	HOCHTON-LAUTSPRECHER	TWEETER
0206.000		296362140100		ABDECKUNG LS	COVER LOUDSPEAKER CPL
0217.000		296088640102	4	SOCKELEINLAGE	BASE INSERT
0225.000		296361860801		KLAPPE OFB	FLAP SURFACE TREATED
0226.000		296341120100	2	KLAPPENLAGER KPL.	FLAP BEARING CPL.
0229.000		296322840101		EMBLEM GRUNDIG	EMBLEM GRUNDIG
0230.000		296365120101		IR-FENSTER DRUCK KPL	IR WINDOW PRINT CPL
0300.000		296361788914		GEH-RUECKTEIL	CABINET REAR PART
0312.000		297006530101		ABDECKUNG FLASH	COVER FLASH
0314.000		297006513102		ABDECKUNG M.KOAX-KABEL	COVER W.COAX CABLE
0320.000		291105306403		TYPENAUFKLEBER VNA	TYPE LABEL VNA
0700.000!		092461547502		ENTMAG.-ROTATIONSSPULEN SET M.HALTER KPL	DEGAUSSING ROTATING COIL SET W.HOLDER CP
0740.000		296073090101	2	HALTER ENTMAG.-ROTATIONSSPULEN	HOLDER DEGAUSSING ROTATING COIL
0900.000!		292014771101		FOKUS U.UG2-REGLER	FOCUS AND UG2-CONTROLLER
0910.000		292014760102	2	FOKUSLEITUNG M.TUELLE ROT	FOCUSING CABLE WITH GROMM RED
0910.000		292014760202		FOKUSLEITUNG M.TUELLE BLAU	FOCUSING CABLE WITH GROMM BLUE
0940.000		297006542101		HALTER FOKUSBLOCK	HOLDER FOCUS UNIT
0940.000		292104087306		SHIFTSTECKER KPL 4 W/330 OHM	SHIFT PLUG CPL 4 W/330 OHM
0940.000		292104087606		SHIFTSTECKER KPL 5 W/180 OHM	SHIFT PLUG CPL 5 W/180 OHM
0950.000		293050085100		BUCHSENPLATTE DIGI 100	SOCKET BOARD DIGI 100
0951.000		293031688100		CINCH-BUCHSE 3-FACH FBAS/NF L,R	CINCH SOCKET 3 FOLD FBAS/AF L,R
0952.000		293033904200		KOPFHOERERBUCHSE 3,5 O.SCHALTER	HEADPHONE SOCKET 3,5 W/O SWITCH
0953.000		295016990100		AUFNAHME-BUCHSENPLATTE	HOLDER PCB SOCKETBOARD
1100.000		830007623000		BILDR.W 76 ESF 031X44 PHILIPS	PICT.TUBE W 76 ESF 031X44 PHILIPS
1110.000!		292013601106		ANODENKAPPE M.HOCHSPANNUNGSKABEL	ANODE CAP W.HIGH VOLTAGE
1300.000		295010840800		KEYBOARD DIGI 100 KEIN E-TEIL	KEYBOARD DIGI 100 NO SPARE PART
1311.000		297033570100		TASTSCHALTER PROGRAMM +	KEY SWITCH PROGRAMME +
1312.000		297033570100		TASTSCHALTER PROGRAMM -	KEY SWITCH PROGRAMME -
1313.000		297033570100		TASTSCHALTER LAUTSTAERKE +	KEY SWITCH VOLUME +
1314.000		297033570100		TASTSCHALTER LAUTSTAERKE -	KEY SWITCH VOLUME -
1350.000		295016980103		TASTEN-SATZ PROGRAMM/LAUTSTAERKE	KEYS SET PROGRAMME/VOLUME
1900.000!		295010870900		NETZSCHALTERPLATTE DIGI 100	POWER SWITCH BOARD DIGI 100
1960.000!		297033910600		NETZSCHALTER O.WISCHER	POWER SWITCH W/O WIPER
1970.000		295016960100		TASTE M.LICHTLEITER KPL	KEY LIGHT GUIDE CPL
2100.000!		829099131600		NETZKABEL	POWER CABLE
2300.000		293051223600	X	BILDROHRPLATTE	PICTURE TUBE BOARD
2400.000		296420614102		TP 100 C FERNBEDIENUNG	TP 100 C REMOTE CONTROL
2410.000		720086730000		DECKEL BATTERIE TP 100 C	BATTERY LID TP 100 C

ÄNDERUNGEN VORBEHALTEN / SUBJECT TO ALTERATION

POS. NR. POS. NO.	ABB. FIG.	MATERIAL-NR. PART NUMBER	ANZ. QTY.	BEZEICHNUNG (D)	DESCRIPTION (GB)
		222179410200		BEDIENUNGSANLEITUNG D	OPERATING INSTRUCTIONS D
		222179410300		BEDIENUNGSANLEITUNG F/I	OPERATING INSTRUCTIONS F/I
		222179410400		BEDIENUNGSANLEITUNG GB/NL	OPERATING INSTRUCTIONS GB/NL
		222179410500		BEDIENUNGSANLEITUNG E/P	OPERATING INSTRUCTIONS E/P
		222179410600		BEDIENUNGSANLEITUNG DK/FIN	OPERATING INSTRUCTIONS DK/FIN
		222179410700		BEDIENUNGSANLEITUNG S/N	OPERATING INSTRUCTIONS S/N
		720100305000		SERVICE MANUAL D/GB	SERVICE MANUAL D/GB
		720100305400		SERVICE MANUAL D/GB 4.ERGAENZUNG	SERVICE MANUAL D/GB 4TH SUPPLEMENT
		720100305500		SERVICE MANUAL D/GB 5.ERGAENZUNG	SERVICE MANUAL D/GB 5TH SUPPLEMENT
		296560043301		MONTAGEZUBEHOER F.BILDROHR KEIN E-TEIL	MOUNTING ACCESSORIES F.PT NO SPARE PART
		297040192500	X	CHASSIS-FS-STEREO CUC 1935 DIGI 100 KEIN E-TEIL	CHASSIS TV STEREO CUC 1935 DIGI 100 NO SPARE PART
				X-SIEHE GESONDERTE E-LISTE	X=SEE SEPARATE PARTS LIST

POS. NR. POS. NO.	MATERIAL-NR. PART NUMBER	BEZEICHNUNG DESCRIPTION	POS. NR. POS. NO.	MATERIAL-NR. PART NUMBER	BEZEICHNUNG DESCRIPTION
	293050085100	BUCHSENPLATTE DIGI 100 SOCKET BOARD DIGI 100			
IC 84001	830546123600	IC TSOP1236 TEMIC			
	295010870900	NETZSCHALTERPLATTE DIGI 100 POWER SWITCH BOARD DIGI 100			
D 85001	830998411900	LE-DIODE L-119EGW			

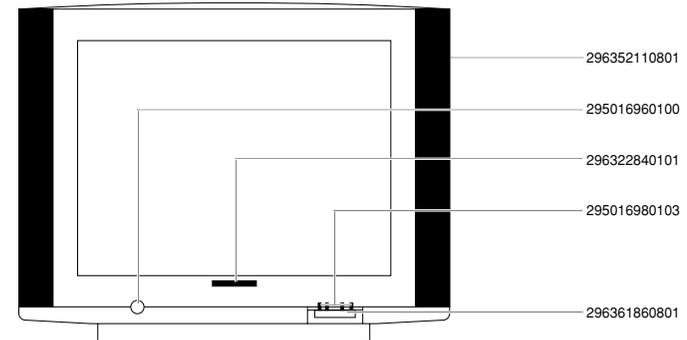

Es gelten die Vorschriften und Sicherheitshinweise gemäß dem Service Manual "Sicherheit", Mat.-Nummer 720108000000, sowie zusätzlich die eventuell abweichenden, landesspezifischen Vorschriften!



The regulations and safety instructions shall be valid as provided by the "Safety" Service Manual, part number 720108000000, as well as the respective national deviations.

ÄNDERUNGEN VORBEHALTEN / SUBJECT TO ALTERATION

MATERIAL-NR. / PART NO.: 922204016900 BESTELL-NR. / ORDER NO.: GCL7900 TESSA BLACK  
VERSION NR./VERSION NO.: VNA

POS. NR. POS. NO.	ABB. FIG.	MATERIAL-NR. PART NUMBER	ANZ. QTY.	BEZEICHNUNG (D)	DESCRIPTION (GB)
		922204016900		HAMBURG SE 8240 DOLBY TESSA BLACK KEIN E-TEIL	HAMBURG SE 8240 DOLBY TESSA BLACK NO SPARE PART
0050.000				PROGRAMM FLASH-EPROM <b>DEUTSCHLAND</b> DOWNLOAD: HTTP://PARTNERWEB. GRUNDIG.DE/KUNDENDIENST	PROGRAM FLASH EPROM <b>GERMANY</b> DOWNLOAD: HTTP://PARTNERWEB. GRUNDIG.DE/KUNDENDIENST
0050.000				PROGRAMM FLASH-EPROM <b>INTERNATIONAL</b> DOWNLOAD: WWW.GRUNDIG.DE/ PRODUKTE/KONTAKT/HAENDLERSERVICE	PROGRAM FLASH EPROM <b>INTERNATIONAL</b> DOWNLOAD: WWW.GRUNDIG.DE/ PRODUCTS/CONTACT/RESELLER SUPPORT
0201.000 0240.000 0241.000 0312.000 0320.000		191260459700 293033904200 293031680503 297006510104 291105176401	2	LS-KOMBI 8 OHM KOPFHOERERBUCHSE 3,5 O.SCHALTER CINCH-BUCHSE 3-FACH FBAS/NF L,R ABDECKUNG DIGI-100 TYPENAUFKLEBER VNA	SPEAKER COMBI 8 OHM HEADPHONE SOCKET 3,5 W/O SWITCH CINCH SOCKET 3 FOLD FBAS/AF L,R COVER DIGI-100 TYPE LABEL VNA
0900.000 0940.000	△	292014771102 297006542101		FOKUS U.UG2-REGLER HALTER FOKUSBLOCK	FOCUS AND UG2-CONTROLLER HOLDER FOCUS UNIT
0950.000 0950.000 1100.000		292104087606 292104087306 830007623000		SHIFTSTECKER KPL 5 W/180 OHM SHIFTSTECKER KPL 4 W/330 OHM BILDR.W76ESF031X44 PHILIPS	SHIFT PLUG CPL 5 W/180 OHM SHIFT PLUG CPL 4 W/330 OHM PICT.TUBE W76ESF031X44 PHILIPS
1301.000 1350.000 1352.000 1353.000 1354.000 1370.000 1371.000		295017610204 295017660102 295017620202 270332210100 296380230101 295017612102 293033750802	2	BEDIENEINSATZ MONT.KPL TASTEN-SATZ PROGRAMM/LAUTSTAERKE KLAPPE DRUCK KPL BEDIENEINSATZ DRUCKSCHNAPPER DAEMPFUNGSBLOCK KLAPPE TASTENKNOPF NETZ DRUCKFEDER TASTENKNOPF NETZ	CONTROL INSERT MOUNT.CPL KEYS SET PROGRAMME/VOLUME FLAP PRINT CPL CONTROL INSERT PRESSURE CATCH DAMPING BLOCK FLAP KEY KNOB POWER PRESSURE SPRING KEY KNOB POWER
2410.000		720086734000		DECKEL BATTERIE TP 912 C	BATTERY LID TP 912 C
		222049410100 720100305000 720100305400 720100305500 720100305600		BEDIENUNGSANLEITUNG D SERVICE MANUAL D/GB SERVICE MANUAL D/GB 4.ERG. SERVICE MANUAL D/GB 5.ERGAENZUNG SERVICE MANUAL D/GB 6.ERGAENZUNG	OPERATING INSTRUCTIONS D SERVICE MANUAL D/GB SERVICE MANUAL D/GB 4TH SUPPLEMENT SERVICE MANUAL D/GB 5TH SUPPLEMENT SERVICE MANUAL D/GB 6TH SUPPLEMENT
		297040194000	X	CHASSIS-FS-STEREO CUC 1935 DIGI 100 KEIN E-TEIL	CHASSIS TV STEREO CUC 1935 DIGI 100 NO SPARE PART
				X=SIEHE GESONDERTE E-LISTE	X=SEE SEPARATE PARTS LIST
				ALLE WEITEREN TEILE SIEHE E-LISTE HAMBURG SE 8240 DOLBY TESSA BLACK MAT.-NR.: 922204016900 BESTELL-NR.: GCL7900 AUSGABE 11/2000 VERSION NR.: VNM	FOR ALL OTHER PARTS SEE HAMBURG SE 8240 DOLBY TESSA BLACK PART NO: 922204016900 ORDER NR: GCL7900 EDITION 11/2000 VERSION NO.: VNM

ÄNDERUNGEN VORBEHALTEN / SUBJECT TO ALTERATION

POS. NR. MATERIAL-NR. BEZEICHNUNG  
POS. NO. PART NUMBER DESCRIPTION

POS. NR. MATERIAL-NR. BEZEICHNUNG  
POS. NO. PART NUMBER DESCRIPTION

### HAMBURG SE 8240 DOLBY

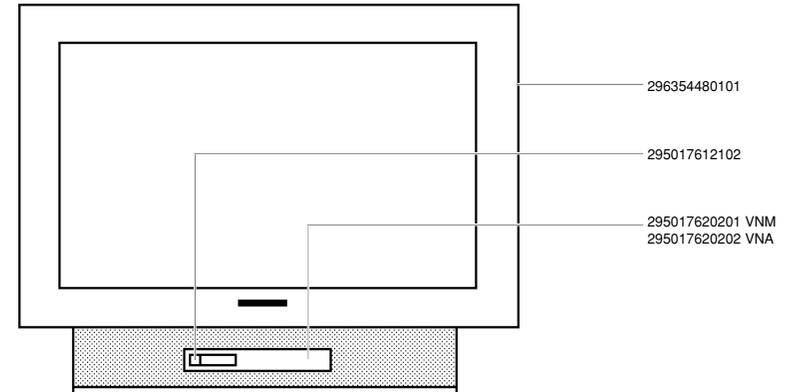

296354480101

295017612102

295017620201 VNM  
295017620202 VNA

Es gelten die Vorschriften und Sicherheitshinweise gemäß dem Service Manual "Sicherheit", Mat.-Nummer 720108000000, sowie zusätzlich die eventuell abweichenden, landesspezifischen Vorschriften!



The regulations and safety instructions shall be valid as provided by the "Safety" Service Manual, part number 720108000000, as well as the respective national deviations.

ÄNDERUNGEN VORBEHALTEN / SUBJECT TO ALTERATION

### 12 / 2001

### DENVER FLAT SE 8260/8 DOLBY

MATERIAL-NR. / PART NO.: 922203027500 BESTELL-NR. / ORDER NO.: GCM4000 SCHWARZ/BLACK  
VERSION NR./VERSION NO.: VNA

POS. NR. POS. NO.	ABB. FIG.	MATERIAL-NR. PART NUMBER	ANZ. QTY.	BEZEICHNUNG (D)	DESCRIPTION (GB)
		922203027500		DENVER FLAT SE 8260/8 DOLBY SCHWARZ KEIN E-TEIL	DENVER FLAT SE 8260/8 DOLBY BLACK NO SPARE PART
0208.000 0320.000		297006510401 291105286401		ABDECKUNG DIGI-100 TYPENAUFKLEBER VNA	COVER DIGI 100 TYPE LABEL VNA
		222039410600 222039410700 222039410800 720100305000 720100305200 720100305300		BEDIENUNGSANLEITUNG D/N BEDIENUNGSANLEITUNG F/I BEDIENUNGSANLEITUNG E/P SERVICE MANUAL D/GB SERVICE MANUAL D/GB 2.ERGAENZUNG SERVICE MANUAL D/GB 3.ERGAENZUNG	OPERATING INSTRUCTIONS D/N OPERATING INSTRUCTIONS F/I OPERATING INSTRUCTIONS E/P SERVICE MANUAL D/GB SERVICE MANUAL D/GB 2ND SUPPLEMENT SERVICE MANUAL D/GB 3ND SUPPLEMENT
				ALLE WEITEREN TEILE SIEHE E-LISTE DENVER FLAT SE 8260/8 DOLBY MAT.-NR.:922203027500 BESTELL-NR.:GCM4000 AUSGABE 5/2001 VERSION NR.: VNM	FOR ALL ORTHER PARTS SEE DENVER FLAT SE 8260/8 DOLBY PART NO.:922203027500 ORDNER NO.:GCM4000 EDITION 5/2001 VERSION NO.: VNM

### 12 / 2001

### DENVER FLAT SE 8260/8 DOLBY

MATERIAL-NR. / PART NO.: 922203027500 BESTELL-NR. / ORDER NO.: GCM4000 SCHWARZ/BLACK  
VERSION NR./VERSION NO.: VNX

POS. NR. POS. NO.	ABB. FIG.	MATERIAL-NR. PART NUMBER	ANZ. QTY.	BEZEICHNUNG (D)	DESCRIPTION (GB)
		922203027500		DENVER FLAT SE 8260/8 DOLBY SCHWARZ KEIN E-TEIL	DENVER FLAT SE 8260/8 DOLBY BLACK NO SPARE PART
0050.000		297981213000		PROGRAMM FLASH-EPROM DOWNLOAD: WWW.GRUNDIG.DE/PRODUKTE/KONTAKT/ HAENDLERSERVICE	PROGRAM FLASH EPROM DOWNLOAD: WWW.GRUNDIG.DE/PRODUCTS/CONTACT/ RESELLER SUPPORT
0208.000 0313.000 0320.000 1352.000		297006510401 296364568703 291105286501 296367100103		ABDECKUNG DIGI-100 ABDECKUNG SCHRAUBE GEH-RUECKTEIL TYPENAUFKLEBER VNX KLAPPE DRUCK KPL	COVER DIGI 100 COVER SCREW CABINET REAR PART TYPE LABEL VNX FLAP PRINT CPL
		222039410200 222039410300 222039410400 222039410900 720100305000 720100305500		BEDIENUNGSANLEITUNG D/N BEDIENUNGSANLEITUNG F/I BEDIENUNGSANLEITUNG E/P BEDIENUNGSANLEITUNG TELEWEB F/D SERVICE MANUAL D/GB SERVICE MANUAL D/GB 5.ERGAENZUNG	OPERATING INSTRUCTIONS D/N OPERATING INSTRUCTIONS F/I OPERATING INSTRUCTIONS E/P OPERATING INSTRUCTIONS TELEWEB F/D SERVICE MANUAL D/GB SERVICE MANUAL D/GB 5TH SUPPLEMENT
		297040193900	X	CHASSIS-FS-STEREO CUC 1935 DIGI 100 KEIN E-TEIL	CHASSIS TV STEREO CUC 1935 DIGI 100 NO SPARE PART
				X = SIEHE GESONDERTE E-LISTE	X = SEE SEPARATE PARTS LIST
				ALLE WEITEREN TEILE SIEHE E-LISTE DENVER FLAT SE 8260/8 DOLBY MAT.-NR.:922203027500 BESTELL-NR.:GCM4000 AUSGABE 5/2001 VERSION NR.: VNM	FOR ALL ORTHER PARTS SEE DENVER FLAT SE 8260/8 DOLBY PART NO.:922203027500 ORDNER NO.:GCM4000 EDITION 5/2001 VERSION NO.: VNM

Es gelten die Vorschriften und Sicherheitshinweise gemäß dem Service Manual "Sicherheit", Mat.-Nummer 720108000000, sowie zusätzlich die eventuell abweichenden, landesspezifischen Vorschriften!



The regulations and safety instructions shall be valid as provided by the "Safety" Service Manual, part number 720108000000, as well as the respective national deviations.

ÄNDERUNGEN VORBEHALTEN / SUBJECT TO ALTERATION

Es gelten die Vorschriften und Sicherheitshinweise gemäß dem Service Manual "Sicherheit", Mat.-Nummer 720108000000, sowie zusätzlich die eventuell abweichenden, landesspezifischen Vorschriften!



The regulations and safety instructions shall be valid as provided by the "Safety" Service Manual, part number 720108000000, as well as the respective national deviations.

ÄNDERUNGEN VORBEHALTEN / SUBJECT TO ALTERATION

9 / 2002

**DENVER FLAT SE 8260/8 DOLBY**

MATERIAL-NR. / PART NO.: 922203027500 BESTELL-NR. / ORDER NO.: GCM4000 SCHWARZ/BLACK  
VERSION NR./VERSION NO.: VNG

POS. NR. POS. NO.	ABB. FIG.	MATERIAL-NR. PART NUMBER	ANZ. QTY.	BEZEICHNUNG (D)	DESCRIPTION (GB)
		922203027500		DENVER FLAT SE 8260/8 DOLBY SCHWARZ KEIN E-TEIL	DENVER FLAT SE 8260/8 DOLBY BLACK NO SPARE PART
0050.000		PROGRAMM FLASH-EPROM <b>DEUTSCHLAND</b> DOWNLOAD: HTTP://PARTNERWEB. GRUNDIG.DE/KUNDENDIENST		PROGRAMM FLASH-EPROM <b>GERMANY</b> DOWNLOAD: HTTP://PARTNERWEB. GRUNDIG.DE/KUNDENDIENST	PROGRAM FLASH EPROM <b>GERMANY</b> DOWNLOAD: HTTP://PARTNERWEB. GRUNDIG.DE/KUNDENDIENST
0050.000		PROGRAMM FLASH-EPROM <b>INTERNATIONAL</b> DOWNLOAD: WWW.GRUNDIG.DE/ PRODUKTE/KONTAKT/HAENDLERSERVICE		PROGRAMM FLASH-EPROM <b>INTERNATIONAL</b> DOWNLOAD: WWW.GRUNDIG.DE/ PRODUKTE/KONTAKT/HAENDLERSERVICE	PROGRAM FLASH EPROM <b>INTERNATIONAL</b> DOWNLOAD: WWW.GRUNDIG.DE/ PRODUCTS/CONTACT/RESELLER SUPPORT
0208.000		297006510401		ABDECKUNG DIGI-100/3EURO-AV	COVER DIGI-100/3EURO-AV
0313.000		296364568703		ABDECKUNG SCHRAUBE GEH-RUECKTEIL	COVER SCREW CABINET REAR PART
0320.000		291105286601		TYPENAUFKLEBER VNG	TYPE LABEL VNG
0950.000		292104087606		SHIFTSTECKER KPL 5 W/180 OHM	SHIFT PLUG CPL 5 W/180 OHM
0950.000		292104087306		SHIFTSTECKER KPL 4 W/330 OHM	SHIFT PLUG CPL 4 W/330 OHM
1100.000		830006634200		BILDR.W76ERF342X044 PHILIPS	PICT.TUBE W76ERF342X044 PHILIPS
1352.000		296367100103		KLAPPE DRUCK KPL BEDIENUNG	FLAP PRINT CPL CONTROL
		222039410200		BEDIENUNGSANLEITUNG D/N	OPERATING INSTRUCTIONS D/N
		222039410300		BEDIENUNGSANLEITUNG F/I	OPERATING INSTRUCTIONS F/I
		222039410400		BEDIENUNGSANLEITUNG E/P	OPERATING INSTRUCTIONS E/P
		222039410900		BEDIENUNGSANLEITUNG TELEWEB F/D	OPERATING INSTRUCTIONS TELEWEB F/D
		720100305000		SERVICE MANUAL D/GB	SERVICE MANUAL D/GB
		720100305400		SERVICE MANUAL D/GB 4.ERGAENZUNG	SERVICE MANUAL D/GB 4TH SUPPLEMENT
		720100305500		SERVICE MANUAL D/GB 5.ERGAENZUNG	SERVICE MANUAL D/GB 5TH SUPPLEMENT
		720100305600		SERVICE MANUAL D/GB 6.ERGAENZUNG	SERVICE MANUAL D/GB 6TH SUPPLEMENT
		297040196400	X	CHASSIS-FS-STEREO CUC 1935 DIGI 100 KEIN E-TEIL	CHASSIS TV STEREO CUC 1935 DIGI 100 NO SPARE PART
				X=SIEHE GESONDERTE E-LISTE	X=SEE SEPARATE PARTS LIST
				ALLE WEITEREN TEILE SIEHE E-LISTE DENVER FLAT SE 8260/8 DOLBY SCHWARZ MAT.-NR.: 922203027500 BESTELL-NR.: GCM4000 AUSGABE 5/2001 VERSION NR.: VNM	FOR ALL OTHER PARTS SEE DENVER FLAT SE 8260/8 DOLBY BLACK PART NO.: 922203027500 ORDER NR.: GCM4000 EDITION 5/2001 VERSION NO.: VNM

Es gelten die Vorschriften und Sicherheitshinweise gemäß dem Service Manual "Sicherheit", Mat.-Nummer 720108000000, sowie zusätzlich die eventuell abweichenden, landesspezifischen Vorschriften!



The regulations and safety instructions shall be valid as provided by the "Safety" Service Manual, part number 720108000000, as well as the respective national deviations.

ÄNDERUNGEN VORBEHALTEN / SUBJECT TO ALTERATION

11 / 2001

**DENVER FLAT SE 8260/8 DOLBY**

MATERIAL-NR. / PART NO.: 922203029200 BESTELL-NR. / ORDER NO.: GCM4010 TITANE  
VERSION NR./VERSION NO.: VNX

POS. NR. POS. NO.	ABB. FIG.	MATERIAL-NR. PART NUMBER	ANZ. QTY.	BEZEICHNUNG (D)	DESCRIPTION (GB)
		922203029200		DENVER FLAT SE 8260/8 DOLBY TITANE KEIN E-TEIL	DENVER FLAT SE 8260/8 DOLBY TITANE NO SPARE PART
0050.000		297981213000		PROGRAMM FLASH-EPROM DOWNLOAD: WWW.GRUNDIG.DE/PRODUKTE/KONTAKT/ HAENDLERSERVICE	PROGRAM FLASH EPROM DOWNLOAD: WWW.GRUNDIG.DE/PRODUCTS/CONTACT/ RESELLER SUPPORT
0200.000		296354150401		GEH-VORDERTEIL KPL	CABINET FRONT PART CPL
0201.000		296383530601	2	BOX KPL (8 OHM/TITANE)	BOX CPL (8 OHM/BLACK)
0208.000		297006510401		ABDECKUNG DIGI-100	COVER DIGI-100
0217.000		296088640102	5	SOCKELEINLAGE	BASE INSERT
0222.000		296383290103		RAHMEN-OBERTEIL SILBER	FRAME UPPER PART SILVER
0221.000		296383300103	2	RAHMEN-SEITENTEIL SILBER	FRAME SIDE PART SILVER
WW.		772000522800		RAHMEN KPL HOLZ DUNKEL	FRAME CPL WOOD DARKLEY
WW.		772000523400		RAHMEN KPL HOLZ HELL	FRAME CPL WOOD BRIGHTLY
WW.		772000525500		RAHMEN KPL ROT	FRAME CPL RED
WW.		772000525800		RAHMEN KPL BLAU	FRAME CPL BLUE
0300.000		296363191401		GEH-RUECKTEIL KPL OFB	CABINET REAR PART CPL SUR
0312.000		297006530101		ABDECKUNG FLASH	COVER FLASH
0313.000		296364568703		ABDECKUNG SCHRAUBE GEH-RUECKTEIL	COVER SCREW CABINET REAR PART
0315.000		191540310300		LAUTSPRECHER TIEFTON	LOUDSPEAKER WOOFER
0320.000		291105286501		TYPENAUFKLEBER VNX	TYPE LABEL VNX
0350.000		296363200103	2	ZWISCHENSTUECK RUECKWANDBEFEST.	INTERMEDIATE PIECE CABINET REAR PART
0500.000		295042041500		BAUSTEIN SUBWOOFER	MODULE SUBWOOFER
0700.000		092461547502		ENTMAG.-ROTATIONSSPULEN M.HALTER	DEGAUSSING ROTATING COIL W.HOLDER
0740.000		296073090101	2	SPULENHALTER	HOLDER COIL
0750.000		812612529600	4	EINSATZBUCHSE BILDROHR	INSERT SOCKET PICT.TUBE
0900.000		292014770100		FOKUS U.UG2-REGLER	FOCUS AND UG2-CONTROLLER
0910.000		292014760102	2	FOKUSLEITUNG M.TUELLE ROT	FOCUSING CABLE WITH GROMMET RED
0910.000		292014760202		FOKUSLEITUNG M.TUELLE BLAU	FOCUSING CABLE WITH GROMMET BLUE
0940.000		297006542101		HALTER FOKUSBLOCK	HOLDER FOCUS UNIT
1100.000		830007603100		BILDR.W 76 ERF 341X044 PHILIPS	PICT.TUBE W 76 ERF 341X044 PHILIPS
1110.000		292013601106		ANODENKAPPE M.HOCHSPANNUNGSKABEL	ANODE CAP W.HIGH VOLTAGE CABLE
1250.000		293051603800		BAUSTEIN EURO-AV	MODULE EURO-AV
1251.000		293031197100		EURO-AV BUCHSENLEISTE 21-POL BLAU	EURO-AV SOCKET STRIP 21 P BLUE
1300.000		296364421700		BEDIENUNGSEINSATZ KPL KEIN E-TEIL	CONTROL INSERT CPL NO SPARE PART
1301.000		296363570401		BEDIENUNGSEINSATZ DRUCK KPL	CONTROL INSERT PRINT CPL
1305.000		295010840400		KEYBOARD/BEDIENUNG KEIN E-TEIL	KEYBOARD/CONTROL NO SPARE PART
1311.000		297033571100		TASTSCHALTER PROGRAMM +	KEY SWITCH PROGRAMME +
1312.000		297033571100		TASTSCHALTER PROGRAMM -	KEY SWITCH PROGRAMME -
1313.000		297033571100		TASTSCHALTER LAUTSTAERKE +	KEY SWITCH VOLUME +
1314.000		297033571100		TASTSCHALTER LAUTSTAERKE -	KEY SWITCH VOLUME -
1350.000		296363280203		TASTENSATZ PROGRAMM/LAUTSTAERKE	KEY SET PROGRAMME/VOLUME
1352.000		296367100201		KLAPPE DRUCK KPL	FLAP PRINT CPL
1353.000		270332210100		DRUCKSCHNAEPPER	PRESSURE CATCH
1354.000		296380231301		DAEMPFBLOCK	DAMPING BLOCK
1355.000		296322090301		GITTER MITTE KPL	GRID MIDDLE CPL
1382.000		296363260102		IR-FENSTER	IR WINDOW

ÄNDERUNGEN VORBEHALTEN / SUBJECT TO ALTERATION

POS. NR. POS. NO.	ABB. FIG.	MATERIAL-NR. PART NUMBER	ANZ. QTY.	BEZEICHNUNG (D)	DESCRIPTION (GB)
1383.000		293033904200		KOPFHÖRERBUCHSE 3,5 O. SCHALTER	HEADPHONE SOCKET 3.5 W/O SWITCH
1384.000		293031685800		CINCH-BUCHSE 3-FACH FBAS/NF L,R	CINCH SOCKET 3 FOLD FBAS/AF L,R
1387.000		293035220600		S-VHS-BUCHSE O. SCHALTER	S-VHS-SOCKET W/O SWITCH
1900.000	△	295010871600		NETZSCHALTERPLATTE	POWER SWITCH BOARD
WW.	△	295010871700		NETZSCHALTERPLATTE	POWER SWITCH BOARD
1905.000	△	297033911600		NETZSCHALTER O. WISCHER	POWER SWITCH W/O WIPER
		295010871600		NETZSCHALTER O. WISCHER	295010871600
1910.000	△	297032917105		NETZSCHALTER O. WISCHER	POWER SWITCH W/O WIPER
		295010871700		NETZSCHALTER O. WISCHER	295010871700
1970.000		296363270201		NETZTASTENKNOPF	POWER KEY BUTTON
1981.000		295017170100		LICHTLEITER ZU LUB-317-GK	LIGHT GUIDE TO LUB-317-GK
1982.000		295017170201		LICHTLEITER ZU L-119-EWG	LIGHT GUIDE TO L-119-EWG
2100.000	△	829099131600		NETZKABEL	POWER CABLE
2300.000		293051223400	X	BILDROHRPLATTE	PICTURE TUBE BOARD
2400.000		296420613300		TP 912 C FERNBEDIENUNG	TP 912 C REMOTE CONTROL
2410.000		720086734000		DECKEL BATTERIE TP 912 C	BATTERY LID TP 912 C
		222039410200		BEDIENUNGSANLEITUNG D/N	OPERATING INSTRUCTIONS D/N
		222039410300		BEDIENUNGSANLEITUNG F/I	OPERATING INSTRUCTIONS F/I
		222039410400		BEDIENUNGSANLEITUNG E/P	OPERATING INSTRUCTIONS E/P
		222039410900		BEDIENUNGSANLEITUNG TELEWEB F/D	OPERATING INSTRUCTIONS TELEWEB F/D
		720100305000		SERVICE MANUAL D/GB	SERVICE MANUAL D/GB
		720100305500		SERVICE MANUAL D/GB 5.ERG	SERVICE MANUAL D/GB 5TH S
		296560043301		MONTAGEZUBEHOER F. BILDROHR KEIN E-TEIL	MOUNTING ACCESSORIES F. PICTURE NO SPARE PART
		297040193900	X	CHASSIS-FS-STEREO CUC 1935 DIGI 100 KEIN E-TEIL	CHASSIS TV STEREO CUC 1935 DIGI 100 NO SPARE PART

WW = WAHLWEISE  
X = SIEHE GESONDERTE E-LISTE

WW = OPTIONAL  
X = SEE SEPARATE PARTS LIST

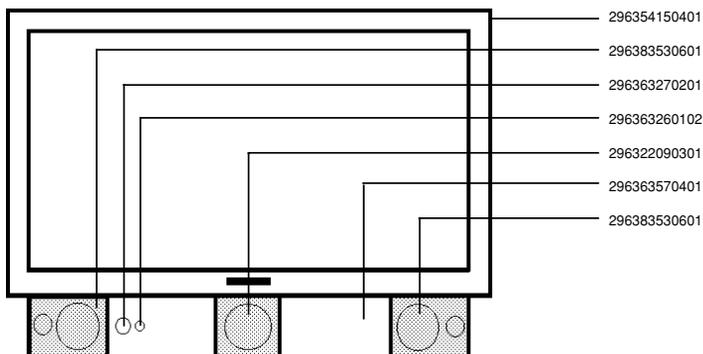

POS. NR. POS. NO.	MATERIAL-NR. PART NUMBER	BEZEICHNUNG DESCRIPTION	POS. NR. POS. NO.	MATERIAL-NR. PART NUMBER	BEZEICHNUNG DESCRIPTION
	295010871600	NETZSCHALTERPLATTE		295010871700	NETZSCHALTERPLATTE
CD 81001	830953414900	MELF-DIODE LL 4148			
CT 81001	830119005000	SMD TRANS BSP50			
CT 81002	830100484800	SMD TRANS BC848B/ BC847B			
	295042041500	BAUSTEIN SUBWOOFER MODULE SUBWOOFER			
	293031563101	FOLIE WAERMELEITEND FOIL HEAT CONDUCTING			
C 40012	845299615000	ELKO 2200UF 20% 25V			
C 44016	845296710400	ELKO AMMO5 1000UF 16V			
CD 40031	833050414800	MELF DIODE MCL4148			
CD 40041	833050414800	MELF DIODE MCL4148			
CD 40061	833050414800	MELF DIODE MCL4148			
CD 40071	833050414800	MELF DIODE MCL4148			
IC 40000	830536729700	IC TDA7297			
	293051603800	BAUSTEIN EURO-AV MODULE EURO-AV			
CD 43334	830953414900	MELF-DIODE LL 4148			
CIC 43310	830578705300	SMD IC 74HC4053			
CT 43305	830100484800	SMD TRANS BC848B/ BC847B			
CT 43315	830100385800	SMD TRANS BC858B/ BC857B			
CT 43320	830100385800	SMD TRANS BC858B/ BC857B			
CT 43330	830100484800	SMD TRANS BC848B/ BC847B			
CT 43340	830100484800	SMD TRANS BC848B/ BC847B			
CT 43360	830100484800	SMD TRANS BC848B/ BC847B			
CT 43365	830100484800	SMD TRANS BC848B/ BC847B			
	295010840400	KEYBOARD/BEDIENUNG KEYBOARD/CONTROL			
D 85001	830998411900	LE-DIODE L-119 EGW			
D 85001	830997837100	LE-DIODE LUB371 GK			
	830546183700	IC TSOP1836YA1			

Es gelten die Vorschriften und Sicherheitshinweise gemäß dem Service Manual "Sicherheit", Mat.-Nummer 720108000000, sowie zusätzlich die eventuell abweichenden, landesspezifischen Vorschriften!



The regulations and safety instructions shall be valid as provided by the "Safety" Service Manual, part number 720108000000, as well as the respective national deviations.

ÄNDERUNGEN VORBEHALTEN / SUBJECT TO ALTERATION

ÄNDERUNGEN VORBEHALTEN / SUBJECT TO ALTERATION

### Ersatzteilliste Spare Parts List

9 / 2002

### DENVER FLAT SE 8260/8 DOLBY

MATERIAL-NR. / PART NO.: 922203029200 BESTELL-NR. / ORDER NO.: GCM4010 TITANE  
VERSION NR./VERSION NO.: VNG

POS. NR. POS. NO.	ABB. FIG.	MATERIAL-NR. PART NUMBER	ANZ. QTY.	BEZEICHNUNG (D)	DESCRIPTION (GB)
		922203029200		DENVER FLAT SE 8260/8 DOLBY TITANE KEIN E-TEIL	DENVER FLAT SE 8260/8 DOLBY TITANE NO SPARE PART
0050.000				PROGRAMM FLASH-EPROM <b>DEUTSCHLAND</b> DOWNLOAD: HTTP://PARTNERWEB. GRUNDIG.DE/KUNDENDIENST	PROGRAM FLASH EPROM <b>GERMANY</b> DOWNLOAD: HTTP://PARTNERWEB. GRUNDIG.DE/KUNDENDIENST
0050.000				PROGRAMM FLASH-EPROM <b>INTERNATIONAL</b> DOWNLOAD: WWW.GRUNDIG.DE/ PRODUKTE/KONTAKT/HAENDLERSERVICE	PROGRAM FLASH EPROM <b>INTERNATIONAL</b> DOWNLOAD: WWW.GRUNDIG.DE/ PRODUCTS/CONTACT/RESELLER SUPPORT
0201.000 0320.000 0950.000 0950.000 1100.000		296383530602 291105286601 292104087606 292104087306 830006634200	2	BOX KPL (8 OHM/TITANE) TYPENAUFKLEBER VNG SHIFTSTECKER KPL 5 W/180 OHM SHIFTSTECKER KPL 4 W/330 OHM BILDR.W76ERF342X044 PHILIPS	BOX CPL (8 OHM/TITANE) TYPE LABEL VNG SHIFT PLUG CPL 5 W/180 OHM SHIFT PLUG CPL 4 W/330 OHM PICT.TUBE W76ERF342X044 PHILIPS
		222039410200 222039410300 222039410400 222039410900 720100305000 720100305400 720100305500 720100305600		BEDIENUNGSANLEITUNG D/N BEDIENUNGSANLEITUNG F/I BEDIENUNGSANLEITUNG E/P BEDIENUNGSANLEITUNG TELEWEB F/D SERVICE MANUAL D/GB SERVICE MANUAL D/GB 4.ERGAENZUNG SERVICE MANUAL D/GB 5.ERGAENZUNG SERVICE MANUAL D/GB 6.ERGAENZUNG	OPERATING INSTRUCTIONS D/N OPERATING INSTRUCTIONS F/I OPERATING INSTRUCTIONS E/P OPERATING INSTRUCTIONS TELEWEB F/D SERVICE MANUAL D/GB SERVICE MANUAL D/GB 4TH SUPPLEMENT SERVICE MANUAL D/GB 5TH SUPPLEMENT SERVICE MANUAL D/GB 6TH SUPPLEMENT
		297040196400	X	CHASSIS-FS-STEREO CUC 1935 DIGI 100 KEIN E-TEIL  X=SIEHE GESONDERTE E-LISTE	CHASSIS TV STEREO CUC 1935 DIGI 100 NO SPARE PART  X=SEE SEPARATE PARTS LIST
				ALLE WEITEREN TEILE SIEHE E-LISTE DENVER FLAT SE 8260/8 DOLBY TITANE MAT.-NR.: 922203029200 BESTELL.-NR.: GCM4010 AUSGABE 11/2001 VERSION NR.: VNX	FOR ALL OTHER PARTS SEE DENVER FLAT SE 8260/8 DOLBY TITANE PART NO: 922203029200 ORDER NR: GCM4010 EDITION 11/2001 VERSION NO.: VNX

Es gelten die Vorschriften und Sicherheitshinweise gemäß dem Service Manual "Sicherheit", Mat.-Nummer 720108000000, sowie zusätzlich die eventuell abweichenden, landesspezifischen Vorschriften!



The regulations and safety instructions shall be valid as provided by the "Safety" Service Manual, part number 720108000000, as well as the respective national deviations.

ÄNDERUNGEN VORBEHALTEN / SUBJECT TO ALTERATION



POS. NR. POS. NO.	MATERIAL-NR. PART NUMBER	BEZEICHNUNG DESCRIPTION
----------------------	-----------------------------	----------------------------

POS. NR. POS. NO.	MATERIAL-NR. PART NUMBER	BEZEICHNUNG DESCRIPTION
----------------------	-----------------------------	----------------------------

R 21523	△	870532102000	MOW 0411 6,2 OHM 5%
R 22501	△	831120001600	PTC DUO T251-A80-A10
R 22506	△	870022905700	KSW NB 0207 220 OHM 5%
R 40502	△	873229600900	DRW 6,5 2,2 OHM 10%
R 50507	△	876642461200	MSW 0207 3 OHM 1%
R 50508	△	876642461200	MSW 0207 3 OHM 1%
R 50526	△	870042900500	KSW NB 0207 1,5 OHM 5%
R 50529	△	876635705900	MSW 0414 270 OHM 5%
R 52502	△	870536123700	MOW 0617 33 OHM 10%
R 52503	△	873023923900	DRW SI ST7 3W 39 OHM 5%
R 52505	△	870536102100	MOW 0617 6,8 OHM 5%
R 52506	△	870536102100	MOW 0617 6,8 OHM 5%
R 53508	△	870042909700	KSW NB 0207 10 KOHM 5% ST
R 53511	△	870522702100	MOW 0411 6,8 OHM 5%
R 53516	△	873028002100	DRW SI S11 7W 6,8 OHM 5%
R 53521	△	870536906300	MOW 0617 390 OHM 5% LI
R 54501	△	873500303300	DRW 0,75W 0,33 OHM 10%
R 55512	△	870536926900	MOW 0617 680 OHM 10% LI
R 55514	△	870123081700	NKS 3 4,7 OHM 5%
R 58501	△	876519810400	MSW 0207 20 KOHM 1%
R 58502	△	876519808400	MSW 0207 3 KOHM 1%
R 60502	△	870006935600	KSW 0617 3 MOHM 2%
R 60504	△	870006934100	KSW 0617 680 KOHM 2%
R 60508	△	873018950100	DRW 9 15 KOHM 10%
R 60512	△	870000743200	KSW 0207 20 OHM 5%
R 60528	△	876504414100	MSW 0411 680 KOHM 5%
R 60801	△	876521212700	MSW 0411 180 KOHM 5%
R 60802	△	831140107400	VDR SIOV-S07K385GS3
R 60803	△	870042904500	KSW NB 0207 68 OHM 5%
R 60806	△	876504915300	MSW SI 0414 2,2 MOHM VDE
R 61508	△	879005005400	ESTR.SK10-A 22 KOHM LIN
R 61512	△	870042904900	KSW NB 0207 100 OHM 5% ST
R 61518	△	870522732100	MOW 0411 100 KOHM 10%
R 61527	△	870536930100	MOW 0617 15 KOHM 10% LI
R 61533	△	873506404900	DRW 4 100 OHM 5%
R 62501	△	876504914500	MSW SI 0414 1 MOHM 5% VDE
R 62502	△	831100501700	NTC 4,7 OHM 30%
R 62503	△	831140127500	VDR SIOV-S14K275E2S11M5
R 62549	△	876634915500	MSW SI 0414 2,7 MOHM 5% LI

SI 52501	△	831560902600	SI LOET T160MA 250V
SI 60501	△	831562000300	SI 5X20 T2A L 250V
SI 61524	△	831562102700	SI LOET T2,5A 250V
SI 61538	△	831561820000	SI LOET T1A 250V
SI 62501	△	831562250300	SI 5X20 T3,15A H 250V

T 21511	△	830340129900	TRANS.BF299 G/PBF259 RS
T 50528	△	830221054400	TRANS BD544B/ BD538
T 50529	△	830221054300	TRANS BD543B/ BD537
T 52503	△	830221068200	TRANS.BD 679A
T 53501	△	830262533100	TRANS 2SC5331
T 60506	△	830263829800	TRANS 2SK2699

TC 22503	△	831001000800	TRIAC BTB08-600CW
----------	---	--------------	-------------------

TR 52501	△	092458129600	TREIBERUEBERTRAGER DRIVER TRANSFORMER
TR 53500	△	292016800200	TRAFO DIODEN-SPLIT DIODE SPLIT TRANSFORMER
TR 60500	△	292015819700	SPERRWANDLERTRAFO REVERSE CONVERTER TRANSFORMER
TR 60801	△	292016299701	SPERRWANDLERTRAFO REVERSE CONVERTER TRANSFORMER

Es gelten die Vorschriften und Sicherheitshinweise gemäß dem Service Manual "Sicherheit", Mat.-Nummer 720108000000, sowie zusätzlich die eventuell abweichenden, landesspezifischen Vorschriften!



The regulations and safety instructions shall be valid as provided by the "Safety" Service Manual, part number 720108000000, as well as the respective national deviations.

ÄNDERUNGEN VORBEHALTEN / SUBJECT TO ALTERATION

## Ersatzteilliste Spare Parts List

### 6 / 2002

## CHASSIS-FS-STEREO CUC 1837 DIGI 100 CHASSIS TV STEREO CUC 1837 DIGI 100

MATERIAL-NR. / PART NO.: 297040110100

POS. NR. POS. NO.	ABB. FIG.	MATERIAL-NR. PART NUMBER	ANZ. QTY.	BEZEICHNUNG ①	DESCRIPTION ②
		297040110100		CHASSIS-FS-STEREO CUC 1837 DIGI 100 KEIN E-TEIL	CHASSIS TV STEREO CUC 1837 DIGI 100 NO SPARE PART
0100.000		295042022100	X	BAUSTEIN SIGNAL / ZF+TUNER	MODULE SIGNAL / IF+TUNER
0216.000		297033571100		TASTSCHALTER PROGRAMM+	KEY SWITCH PROGRAMME+
0216.000		297033571100		TASTSCHALTER PROGRAMM-	KEY SWITCH PROGRAMME-
0216.000		297033571100		TASTSCHALTER LAUTSTAERKE+	KEY SWITCH VOLUME+
0216.000		297033571100		TASTSCHALTER LAUTSTAERKE-	KEY SWITCH VOLUME-
0240.000		293033904200		KOPFHOERERBUCHSE 3,5 O.SCHALTER	HEADPHONE SOCKET 3,5 W/O SWITCH
0241.000		293031680503		CINCH-BUCHSE 3-FACH FBAS/NF L,R	CINCH SOCKET 3 FOLD FBAS/AF L,R
0400.000		295042032200	X	BAUSTEIN FEATURE	MODULE FEATURE
0451.000		297006521102		HALTER BAUSTEIN	HOLDER MODULE
1000.000		096211130206	4	SICHERUNGSHALTER SI60501/62501	FUSE HOLDER SI60501/62501
2000.000		297033910100		NETZSCHALTER O.WISCHER	POWER SWITCH W/O WIPER
2200.000	△	293033994802		NETZ EINBAUGERAETESTECKER	APPLIANCE COUPLER W.CABLE
2400.000		293031530107	2	MONTAGECLIP T53501/60506	MOUNTING CLIP T53501/60506
2410.000		293031530208		MONTAGECLIP IC40510	MOUNTING CLIP IC40510
2420.000		293031531208	8	MONTAGECLIP D53571/53572/ D61516/61521/61524/IC50510/ T50528/50529	MOUNTING CLIP D53571/53572 D61516/61521/61524/IC50510/ T50528/50529
2430.000		293031531605		MONTAGECLIP T52503	MOUNTING CLIP T52503
2440.000		293031561600		ISOLIERUNG D60019	INSULATION D60019
2445.000		293031561700		ISOLIERUNG D60021	INSULATION D60021
2450.000		293031562000	6	FOLIE WAERMELEITEND D61516/61521/ D61524/IC50510/T50528/50529	FOIL HEAT CONDUCTING D61516/61521/ D61524/IC50510/T50528/50529
2460.000		293031562100		FOLIE WAERMELEITEND D53572	FOIL HEAT CONDUCTING D53572
2470.000		293031562300		FOLIE WAERMELEITEND D53571	FOIL HEAT CONDUCTING D53571
2480.000		293031562800	2	FOLIE WAERMELEITEND D60019/60021	FOIL HEAT CONDUCTING D60019/60021
2490.000		293031563301		FOLIE WAERMELEITEND T60506	FOIL HEAT CONDUCTING T60506
				WW.=WAHLWEISE X=SIEHE GESONDERTE E-LISTE	WW.=OPTIONAL X=SEE SEPARATE PARTS LIST

POS. NR. POS. NO.	MATERIAL-NR. PART NUMBER	BEZEICHNUNG DESCRIPTION	POS. NR. POS. NO.	MATERIAL-NR. PART NUMBER	BEZEICHNUNG DESCRIPTION
C 40502	845299615000	ELKO 2200UF 20% 25V	C 61511	865006704600	KERKO HV C 100PF 20% 1KV
C 50512	845299614700	ELKO 1000UF 20% 25V	C 61512	865006704600	KERKO HV C 100PF 20% 1KV
C 50526	845299614700	ELKO 1000UF 20% 25V	C 61514	851591103800	FOKO FKP1 100PF 10% 1600V
C 53512	851591160200	FOKO FKP1 142PF 2,5% 2000V	C 61521	865006704600	KERKO HV C 100PF 20% 1KV
C 53571	851591471900	FOKO FKP1 0,012UF 3,5% 2000V	C 61524	865006704600	KERKO HV C 100PF 20% 1KV
C 60506	865006704600	KERKO HV C 100PF 20% 1KV	C 61561	865006704600	KERKO HV C 100PF 20% 1KV
C 60509	851591104000	FOKO FKP1 220PF 10% 1600V	C 61562	845209701500	ELKO #39 1000UF +50-20% 25V
C 60512	865008111100	KERKO HV C 270PF 20% 2KV	C 61563	845209701500	ELKO #39 1000UF +50-20% 25V
C 60518	851591140300	FOKO FKP1 0,01UF 5% 1250V	C 61566	865006704600	KERKO HV C 100PF 20% 1KV
C 60519	865006704600	KERKO HV C 100PF 20% 1KV	C 62501	△ 851179304700	FOKO MP3/KT 0,47UF20% 275VW
C 60521	865006704600	KERKO HV C 100PF 20% 1KV	C 62502	△ 851179304700	FOKO MP3/KT 0,47UF20% 275VW
C 60523	865008112500	KERKO HV C 1000PF 20% 1KV	C 62521	△ 866009823400	KERKO SI 1000PF 20% 400V
C 60524	865008112500	KERKO HV C 1000PF 20% 1KV	C 62548	△ 866009823800	KERKO SI 2200PF 20% 400V
C 60526	865008112500	KERKO HV C 1000PF 20% 1KV	C 62549	△ 866009823400	KERKO SI 1000PF 20% 400V
C 60527	865008112500	KERKO HV C 1000PF 20% 1KV			
C 60528	△ 844330315000	ELKO SNT #3 150UF 20% 450V	CD 21501	833050414800	MELF DIODE MCL4148
C 60529	△ 851179301800	FOKO MP3 0,1UF 20% 275VW	CD 21502	833050414800	MELF DIODE MCL4148
C 60801	865006703100	KERKO HV C 47PF 20% 2KV	CD 21503	833050414800	MELF DIODE MCL4148
C 60802	865008112500	KERKO HV C 1000PF 20% 1KV	CD 21506	832531310300	MELF DIODE BAV103

ÄNDERUNGEN VORBEHALTEN / SUBJECT TO ALTERATION

POS. NR. POS. NO.	MATERIAL-NR. PART NUMBER	BEZEICHNUNG DESCRIPTION
CD 21666	833050414800	MELF DIODE MCL4148
CD 40536	833050414800	MELF DIODE MCL4148
CD 52503	833050414800	MELF DIODE MCL4148
CD 53519	833050414800	MELF DIODE MCL4148
CD 55503	830945504400	MELF Z-DIODE 4,3 B 0,5W
CD 55504	833050414800	MELF DIODE MCL4148
CD 57501	833050414800	MELF DIODE MCL4148
CD 57503	833050414800	MELF DIODE MCL4148
CD 57504	833050414800	MELF DIODE MCL4148
CD 57506	830945515000	MELF Z-DIODE 15V B 0,5W
CD 58501	833050414800	MELF DIODE MCL4148
CD 58504	833050414800	MELF DIODE MCL4148
CD 58507	830945502800	MELF Z-DIODE 2,7 B 0,5W
CD 58511	833050414800	MELF DIODE MCL4148
CD 58512	833050414800	MELF DIODE MCL4148
CD 58521	833050414800	MELF DIODE MCL4148
CD 58522	833050414800	MELF DIODE MCL4148
CD 60811	833010130200	MELF DIODE BAV 302
CD 60812	832561034100	SMD DIODE STPS340U
CD 61528	832538430100	SMD Z-DIODE BX284B30
CD 61538	832561034100	SMD DIODE STPS340U
CD 61548	832561034100	SMD DIODE STPS340U
CD 61558	832561034100	SMD DIODE STPS340U
CD 70501	830945505100	MELF-Z DIODE 5,1 C 0,5W
CD 85513	830945505200	MELF-Z DIODE 5,1 B 0,5W
CIC 21660	830598600000	SMD IC 74LV00
CL 60504	810498233100	SMD DAEMPF-PERLE 0805
CT 21670	830100484800	SMD TRANS BC848B/ BC847B
CT 40531	830100484800	SMD TRANS BC848B/ BC847B
CT 40591	830100484800	SMD TRANS BC848B/ BC847B
CT 44515	830100484800	SMD TRANS BC848B/ BC847B
CT 57506	830100484800	SMD TRANS BC848B/ BC847B
CT 58512	830100484800	SMD TRANS BC848B/ BC847B
CT 60806	830100685800	SMD TRANS BC858C/ BC857C
CT 61585	830100484800	SMD TRANS BC848B/ BC847B
CT 85505	830100385800	SMD TRANS BC858B/ BC857B
CT 85510	830100385800	SMD TRANS BC858B/ BC857B
D 21512	830921502000	DIODE 1N4004
D 40532	830921504500	DIODE 1N4148
D 50513	830951627200	DIODE BYV27/200
D 52506	830921502000	DIODE 1N4004
D 53508	830920100500	DIODE BA157
D 53519	830970900300	Z DIODE ZY 51
D 53571	830920435900	DIODE BY359 1500
D 53572	830920423000	DIODE BY 229-600
D 54501	830920100500	DIODE BA157
D 55512	830972033300	Z DIODE 33 C 0,5W
D 60019	830919780700	DIODE STTA806D
D 60021	830919780700	DIODE STTA806D
D 60509	830921140600	DIODE SF4006
D 60512	830951675400	DIODE BYT53B
D 60523	830856038400	GLR.SKB380C1500
D 61503	830972009900	Z DIODE 10 B 0,5W
D 61511	830951603800	DIODE BYV38
D 61512	830951603800	DIODE BYV38
D 61516	830951679800	DIODE BYT 08 P-1000
D 61521	830919682000	DIODE STPR820D
D 61524	830919682000	DIODE STPR820D
D 61533	830920100500	DIODE BA157
D 61561	830951717200	DIODE BYW172D
D 61566	830951717200	DIODE BYW172D
D 85501	830998411600	LE-DIODE L-115WEGW
IC 40510	830536729700	IC TDA7297
IC 50510	830512597900	IC STV9379A
IC 55510	830533814500	IC TDA8145

POS. NR. POS. NO.	MATERIAL-NR. PART NUMBER	BEZEICHNUNG DESCRIPTION
IC 58510	830520439300	IC LM393P
IC 60510	830533464600	IC TDA16846
IC 60801	830547026400	IC TNY264
IC 60817	830546543100	IC TS431IZ-AP
IC 61510	830520435700	IC LM358N
IC 61535	830520497800	IC L4978
IC 61545	830520497800	IC L4978
IC 61555	830520497800	IC L4978
IC 84501	830546123600	IC TSOP1236
L 53501	810498205600	FERRITPERLE HF70 BTL 3,5X6
L 53502	810498205600	FERRITPERLE HF70 BTL 3,5X6
L 53503	810498205600	FERRITPERLE HF70 BTL 3,5X6
L 53511	814050524900	DR A AX-GA 10UH 10%
L 53512	092401140400	DROSSEL 1,5 MH/COIL 1.5 MH
L 53521	292031229700	LINEARITAETSREGLER
WW.	292031229500	LINEARITAETSREGLER
L 53574	092468596100	BRUECKENSPULE M.KERN
L 55514	092458160100	BRIDGE COIL W. CORE
L 60506	810498208100	O/W AUSKOPPLSPULE
L 60507	810498208000	E/W DECOUPLING COIL
L 60518	810498208000	FERRITPERLE 0,676UH LI
L 60518	810498208000	FERRITPERLE 0,676UH
L 60528	292017119700	FERRITE BEAD
L 60812	814052499200	SPEICHERDROSSEL EF25/11 1,8MH
L 61511	810498201400	STORAGE CHOKE EF25/11 1.8MH
L 61514	810498201400	SIEB-DR 10UH 15%
L 61521	810498201400	FILTER CHOKE 10UH 15%
L 61524	810498201400	DAEMPF-PERLE 433003038102
L 61527	814052499200	DAEMPF-PERLE 433003038102
L 61538	814052499500	SIEB-DR 10UH 15%
L 61548	814052105900	FILTER CHOKE 10UH 15%
WW.	814052106800	SIEB-DR 330UH
L 61549	814052499200	FILTER CHOKE 330UH
L 61558	814052105900	SPEICHER-DR 59UH 2,5A
WW.	814052106700	STORAGE CHOKE 59UH 2,5A
WW.	814052106800	SPEICHER-DR EF16 67UH EF16
L 61561	810498201400	STORAGE CHOKE 67UH EF16
L 61562	814050506500	STORAGE CHOKE EF16 67UH 2.5A
L 61566	810498201400	SPEICHER-DR 67UH EF16
L 61567	814050506500	STORAGE CHOKE 67UH EF16
L 62501	295008359700	DAEMPF-PERLE 433003038102
OK 22505	830600036200	DAMPING BEAD
WW.	830600024200	DR A AX-GA 47UH 5%
OK 60531	830600001200	DAEMPF-PERLE 433003038102
OK 60546	830600001200	DAMPING BEAD
OK 60805	830600061500	DR A AX-GA 47UH 5%
R 21523	870532122100	ENTSTOER-DR 2X22MH
R 22501	831120001600	INTERFERENCE CHOKE 2X22MH
R 22504	870004912100	

POS. NR. POS. NO.	MATERIAL-NR. PART NUMBER	BEZEICHNUNG DESCRIPTION
R 22506	870022905700	KSW NB 0207 220 OHM 5%
R 40502	873229600900	DRW 6,5 2,2 OHM 10%
R 50507	876642460500	MSW 0207 1,5 OHM 1%
R 50508	876642460500	MSW 0207 1,5 OHM 1%
R 50526	870042900500	KSW NB 0207 1,5 OHM 5%
R 50529	876635705900	MSW 0414 270 OHM 5%
R 52501	870532122100	MOW 0411 6,8 OHM 5%
R 52503	873023923900	DRW SI ST7 3W 39 OHM 5%
R 52505	870536000800	MOW 0617 3,9 OHM 5%
R 52506	870536000800	MOW 0617 3,9 OHM 5%
R 53508	870042909700	KSW NB 0207 10 KOHM 5% ST
R 53511	870522702100	MOW 0411 6,8 OHM 5%
R 53516	873028002100	DRW SI S11 7W 6,8 OHM 5%
R 53521	870536906300	MOW 0617 390 OHM 5% LI
R 54501	873500303300	DRW 0,75W 0,33 OHM 10%
R 55512	870536906500	MOW 0617 470 OHM 5% LI
R 55514	870123081700	NKS 3,4 7 OHM 5%
R 58501	876519810400	MSW 0207 20 KOHM 1%
R 58502	876519808600	MSW 0207 3,6 KOHM 1%
R 60502	870006935600	KSW 0617 3 MOHM 2%
R 60504	870006934100	KSW 0617 680 KOHM 2%
R 60508	873506730100	DRW 7 15 KOHM 10%
R 60512	870000743200	KSW 0207 20 OHM 5%
R 60801	876521212700	MSW 0411 180 KOHM 5%
R 60802	831140107400	VDR SIOV-S07K385GS3
R 60803	870042904500	KSW NB 0207 68 OHM 5%
R 60806	876504915300	FERRITE BEAD
R 61508	879005005400	MSW SI 0414 2,2 MOHM VDE
R 61512	870042904900	ESTR.SK10-A 22 KOHM LIN
R 61518	870522732100	KSW NB 0207 100 OHM 5% ST
R 61527	870536930100	MOW 0411 100 KOHM 10%
R 61533	873506404900	MOW 0617 15 KOHM 10% LI
R 62501	873506404900	DRW 4 100 OHM 5%
R 62502	831100501700	MSW SI 0414 1 MOHM 5% VDE
R 62503	831100501700	NTC 4,7 OHM 30%
R 62503	831140127500	VDR SIOV-S14K275E2S11M5
R 62549	876634915500	VDR SIOV-S14K2,7 MOHM 5% LI
SI 52501	831561202700	SI LOET T315MA 250V
SI 60501	831562000300	SI 5X20 T2A L 250V
SI 61521	831562022500	SI LOET T2A 250V
SI 61524	831562102700	SI LOET T2,5A 250V
SI 61538	831561820000	SI LOET T1A 250V
SI 61561	831562022500	SI LOET T2A 250V
SI 61566	831562022500	SI LOET T2A 250V
SI 62501	831562250300	SI 5X20 T3,15A H 250V
T 21511	830340129900	TRANS.BF299 G/PBF259
T 50528	830221054400	TRANS BD544B/ BD538
T 50529	830221054300	TRANS BD543B/ BD537
T 52503	830221068200	TRANS.BD 679A
T 53501	830262533100	TRANS 2SC5331
T 60506	830263829800	TRANS 2SK2699
TC 22503	831001000800	TRIAC BTB08-600CW
TR 52501	092468679700	UEBERTRAGER
TR 53500	292016800300	TRANSFORMER
TR 60500	292015819700	TRAF0 DIODEN-SPLIT
TR 60801	292016299701	DIODE SPLIT TRANSFORMER
		SPERRWANDLERTRAF0
		REVERSE CONVERTER
		TRANSFORMER
		SPERRWANDLERTRAF0
		REVERSE CONVERTER
		TRANSFORMER

Es gelten die Vorschriften und Sicherheitshinweise gemäß dem Service Manual "Sicherheit", Mat.-Nummer 720108000000, sowie zusätzlich die eventuell abweichenden, landesspezifischen Vorschriften!



The regulations and safety instructions shall be valid as provided by the "Safety" Service Manual, part number 720108000000, as well as the respective national deviations.

ÄNDERUNGEN VORBEHALTEN / SUBJECT TO ALTERATION

ÄNDERUNGEN VORBEHALTEN / SUBJECT TO ALTERATION



POS. NR. MATERIAL-NR. BEZEICHNUNG  
POS. NO. PART NUMBER DESCRIPTION

R 53521 △ 870536906300 MOW 0617 390 OHM 5%  
R 54501 △ 873500303300 DRW 0,75W 0,33 OHM 10%  
R 55512 △ 870536906500 MOW 0617 470 OHM 5%  
R 55514 △ 870123081700 NKS 3 4,7 OHM 5%  
R 58501 876519810400 MSW 0207 20 KOHM 1%  
R 60502 870006935600 KSW 0617 3 MOHM 2%  
R 60504 870006934100 KSW 0617 680 KOHM 2%  
R 60508 873506730100 DRW 7 15 KOHM 10%  
R 60512 870004903200 KSW 0411 20 OHM 5%  
R 60528 876504414100 MSW 0411 680 KOHM 5%  
R 60801 876521212700 MSW 0411 180 KOHM 5%  
R 60802 △ 831140107400 VDR SIOV-S07K385GS3  
R 60803 △ 870042904500 KSW NB 0207 68 OHM 5%  
R 61508 879005005400 ESTR.SK10-A 22 KOHM LIN  
R 61512 △ 870042904900 KSW NB 0207 100 OHM 5%  
R 61518 870522732100 MOW 0411 100 KOHM 10%  
R 61527 △ 870536930100 MOW 0617 15 KOHM 10%  
R 61533 873506404900 DRW 4 100 OHM 5%  
R 61572 879005004000 ESTR.SK10-A 2,2 KOHM LIN  
R 62501 △ 876504914500 MSW SI 0414 1 MOHM 5% VDE  
R 62502 831100501700 NTC 4,7 OHM  
R 62503 △ 831140127500 VDR SIOV-S14K275E2  
R 62549 △ 876634915500 MSW SI 0414 2,7 MOHM 5%

SI 52501 △ 831561202700 SI LOET T315MA 250V  
SI 60501 △ 831562000300 SI 5X20 T2A L 250V  
SI 61521 △ 831562022500 SI LOET T2A 250V  
SI 61524 △ 831562102700 SI LOET T2,5A 250V  
SI 61538 △ 831561820000 SI LOET T1A 250V  
SI 61561 △ 831562022500 SI LOET T2A 250V  
SI 61566 △ 831562022500 SI LOET T2A 250V  
SI 62501 △ 831562250300 SI 5X20 T3,15A H 250V

T 21511 830340129900 TRANS.BF299 G/ PBF259  
T 50528 830221054400 TRANS BD544B/ BD538  
T 50529 830221054300 TRANS BD543B/ BD537  
T 52503 830221068200 TRANS.BD 679A  
T 53501 830262533100 TRANS 2SC5331  
T 60506 830263829900 TRANS 2SK2699  
T 61505 830225425400 TRANS FET BSN254A

TC 22503 △ 831001000800 TRIAC BTB08-600CW

TR 52501 △ 092468679700 UEBERTRAGER  
TRANSFORMER  
TRAFO DIODEN-SPLIT  
TRANSFORMER DIODES SPLIT  
TR 60500 △ 292015809700 SPERRWANDLERTRAFO  
B.O.-TYPE CONVERTER  
TRANSFORMER  
TR 60800 △ 292016249700 SPERRWANDLERTRAFO  
B.O.-TYPE CONVERTER  
TRANSFORMER

POS. NR. MATERIAL-NR. BEZEICHNUNG  
POS. NO. PART NUMBER DESCRIPTION

## Ersatzteilliste Spare Parts List

### 11 / 2000

### CHASSIS-FS-STEREO CUC 1837 DIGI 100 CHASSIS TV STEREO CUC 1837 DIGI 100

MATERIAL-NR. / PART NO.: 297040111300

POS. NR. POS. NO.	ABB. FIG.	MATERIAL-NR. PART NUMBER	ANZ. QTY.	BEZEICHNUNG (D)	DESCRIPTION (GB)
		297040111300		CHASSIS-FS-STEREO CUC 1837 DIGI 100 KEIN E-TEIL	CHASSIS TV STEREO CUC 1837 DIGI 100 NO SPARE PART
0100.000		295042622100	X	BAUSTEIN SIGNAL / ZF+TUNER	MODULE SIGNAL / IF+TUNER
0240.000		2930339904200		KOPFHOERERBUCHSE 3,5 O.SCHALTER	HEADPHONE SOCKET 3,5 W/O SWITCH
0241.000		293031680503		CINCH-BUCHSE 3-FACH FBAS/NF L,R	CINCH SOCKET 3 FOLD FBAS/AF L,R
0400.000		295042032200	X	BAUSTEIN FEATURE	MODULE FEATURE
0451.000		297006520102		HALTER BAUSTEIN	HOLDER MODULE
1000.000	△	096211130206	4	SICHERUNGSHALTER SI60501/62501	FUSE HOLDER SI60501/62501
1300.000		295017660102		TASTENSATZ PROGRAMM/LAUTSTAEERKE	KEY SET PROGRAMME/VOLUME
1310.000		297033571100		TASTSCHALTER PROGRAMM +	KEY SWITCH PROGRAMME +
1320.000		297033571100		TASTSCHALTER PROGRAMM -	KEY SWITCH PROGRAMME -
1330.000		297033571100		TASTSCHALTER LAUTSTAEERKE +	KEY SWITCH VOLUME +
1340.000		297033571100		TASTSCHALTER LAUTSTAEERKE -	KEY SWITCH VOLUME -
2000.000	△	297033910100		NETZSCHALTER O.WISCHER	POWER SWITCH W/O WIPER
2200.000	△	293033996601		NETZ EINBAUGERAETESTECKER	APPLIANCE PLUG W.WIRE
2400.000		293031530107	2	MONTAGECLIP T53501/60506	MOUNTING CLIP T53501/60506
2410.000		293031530208		MONTAGECLIP IC40510	MOUNTING CLIP IC40510
2420.000		293031531208	9	MONTAGECLIP IC50510/T50528/50529/ D53571/53572/60506/ D61516/61521/61524	MOUNTING CLIP IC50510/T50528/50529 D53571/53572/60506/ D61516/61521/61524
2430.000		293031531605		MONTAGECLIP T52503	MOUNTING CLIP T52503
2440.000		293031561600		ISOLIERUNG D60019	INSULATION D60019
2450.000		293031561700		ISOLIERUNG D60021	INSULATION D60021
2460.000		293031561800		FOLIE WAERMELEITEND D60506	FOIL HEAT CONDUCTING D60506
2470.000		293031562000	6	FOLIE WAERMELEITEND IC50510 T50528/50529/D61516/61521/61524	FOIL HEAT CONDUCTING IC50510 T50528/50529/D61516/61521/61524
2475.000		293031562100		FOLIE WAERMELEITEND D53572	FOIL HEAT CONDUCTING D53572
2480.000		293031562300		FOLIE WAERMELEITEND D53571	FOIL HEAT CONDUCTING D53571
2490.000		293031562800	2	FOLIE WAERMELEITEND D60019/60021	FOIL HEAT CONDUCTING D60019/60021

X = SIEHE GESONDERTE E-LISTE

X = SEE SEPARATE PARTS LIST

POS. NR. MATERIAL-NR. BEZEICHNUNG  
POS. NO. PART NUMBER DESCRIPTION

C 40502 845299615000 ELKO 2200UF 20% 25V  
C 50512 845299614700 ELKO 1000UF 20% 25V  
C 50526 845299614700 ELKO 1000UF 20% 25V  
C 53512 851591160200 FOKO FKP1 142PF 2,5% 2000V  
C 53571 851591471900 FOKO FKP1 0,012UF 3,5% 2000V  
C 60506 865006704600 KERKO HV C 100PF 20% 1KV  
C 60509 851591104000 FOKO FKP1 220PF 10% 1600V  
C 60512 865008111100 KERKO HV C 270PF 20% 2KV  
C 60518 851591140300 FOKO FKP1 0,01UF 5% 1250V  
C 60519 865006704600 KERKO HV C 100PF 20% 1KV  
C 60521 865006704600 KERKO HV C 100PF 20% 1KV  
C 60523 865008112500 KERKO HV C 1000PF 20% 1KV  
C 60524 865008112500 KERKO HV C 1000PF 20% 1KV  
C 60526 865008112500 KERKO HV C 1000PF 20% 1KV  
C 60527 865008112500 KERKO HV C 1000PF 20% 1KV  
C 60528 △ 844330315000 ELKO SNT #3 150UF 20% 450V  
C 60529 △ 851179301800 MP3 0,1UF 20% 250VW

POS. NR. MATERIAL-NR. BEZEICHNUNG  
POS. NO. PART NUMBER DESCRIPTION

C 60801 865006703100 KERKO HV C 47PF 20% 2KV  
C 60802 865008112500 KERKO HV C 1000PF 20% 1KV  
C 61511 865006704600 KERKO HV C 100PF 20% 1KV  
C 61512 865006704600 KERKO HV C 100PF 20% 1KV  
C 61514 851591103800 FOKO FKP1 100PF 10% 1600V  
C 61516 845209713100 ELKO #31 100UF 250V  
C 61521 865006704600 KERKO HV C 100PF 20% 1KV  
C 61524 865006704600 KERKO HV C 100PF 20% 1KV  
C 61561 865006704600 KERKO HV C 100PF 20% 1KV  
C 61562 845209701500 ELKO #39 1000UF +50-20% 25V  
C 61563 845209701500 ELKO #39 1000UF +50-20% 25V  
C 61566 865006704600 KERKO HV C 100PF 20% 1KV  
C 62501 △ 851179304700 FOKO MP3 0,47UF 20% 250VW  
C 62502 △ 851179304700 FOKO MP3 0,47UF 20% 250VW  
C 62521 △ 866009823400 KERKO SI 1000PF 20% 400V  
C 62548 △ 866009823800 KERKO SI 2200PF 20% 400V  
C 62549 △ 866009823400 KERKO SI 1000PF 20% 400V

Es gelten die Vorschriften und Sicherheitshinweise gemäß dem Service Manual "Sicherheit", Mat.-Nummer 720108000000, sowie zusätzlich die eventuell abweichenden, landesspezifischen Vorschriften!



The regulations and safety instructions shall be valid as provided by the "Safety" Service Manual, part number 720108000000, as well as the respective national deviations.

ÄNDERUNGEN VORBEHALTEN / SUBJECT TO ALTERATION

ÄNDERUNGEN VORBEHALTEN / SUBJECT TO ALTERATION





### Ersatzteilliste Spare Parts List

6 / 2002

### CHASSIS-FS-STEREO CUC 1837 DIGI 100 CHASSIS TV STEREO CUC 1837 DIGI 100

MATERIAL-NR. / PART NO.: 297040111500

POS. NR. MATERIAL-NR. BEZEICHNUNG  
POS. NO. PART NUMBER DESCRIPTION

R 52505 △ 870536901700 MOW 0617 4,7 OHM 5% LI  
R 52506 △ 870536901700 MOW 0617 4,7 OHM 5% LI  
R 53508 △ 870042909700 KSW NB 0207 10 KOHM 5% ST  
R 53511 △ 870522702100 MOW 0411 6,8 OHM 5%  
R 53516 △ 873028002100 DRW SI S11 7W 6,8 OHM 5%  
R 53521 △ 870536925700 MOW 0617 220 OHM 10% LI  
R 54501 △ 873500303300 DRW 0,75W 0,33 OHM 10%  
R 55512 △ 870536906500 MOW 0617 470 OHM 5% LI  
R 55514 △ 870123081700 NKS 3 4,7 OHM 5%  
R 58501 △ 876519810400 MSW 0207 20 KOHM 1%  
R 60502 △ 870006935600 KSW 0617 3 MOHM 2%  
R 60504 △ 870006934100 KSW 0617 680 KOHM 2%  
R 60508 △ 873506730100 DRW 7 15 KOHM 10%  
R 60512 △ 870004903200 KSW 0411 20 OHM 5%  
R 60528 △ 876504414100 MSW 0411 680 KOHM 5%  
R 60801 △ 876521212700 MSW 0411 180 KOHM 5%  
R 60802 △ 831140107400 VDR SIOV-S07K385GS3  
R 60803 △ 870042904500 KSW NB 0207 68 OHM 5%  
R 61508 △ 879005005400 ESTR.SK10-A 22 KOHM LIN  
R 61512 △ 870042904900 KSW NB 0207 100 OHM 5% ST  
R 61518 △ 870522732100 MOW 0411 100 KOHM 10%  
R 61527 △ 870536930100 MOW 0617 15 KOHM 10% LI  
R 61533 △ 873506404900 DRW 4 100 OHM 5%  
R 61572 △ 879005004000 ESTR.SK10-A 2,2 KOHM LIN  
R 62501 △ 876504914500 MSW SI 0414 1 MOHM 5% VDE  
R 62502 △ 831100501700 NTC 4,7 OHM 30%  
R 62503 △ 831140127500 VDR SIOV-S14K275E2  
R 62549 △ 876634915500 MSW SI 0414 2,7 MOHM 5% LI

SI 52501 △ 831561202700 SI LOET T315MA 250V  
SI 60501 △ 831562000300 SI 5X20 T2A L 250V  
SI 61521 △ 831562022500 SI LOET T2A 250V  
SI 61524 △ 831562102700 SI LOET T2,5A 250V  
SI 61538 △ 831561820000 SI LOET T1A 250V  
SI 61561 △ 831562022500 SI LOET T2A 250V  
SI 61566 △ 831562022500 SI LOET T2A 250V  
SI 62501 △ 831562250300 SI 5X20 T3,15A H 250V

T 21511 830340129900 TRANS.BF299 G  
T 50528 830221054400 TRANS BD544B/ BD538  
T 50529 830221054300 TRANS BD543B/ BD537  
T 52503 830221068200 TRANS.BD 679A  
T 53501 830262533100 TRANS 2SK5331  
T 60506 830263829900 TRANS 2SK2699  
T 61505 830225425400 TRANS FET BSN254A

TC 22503 △ 831001000800 TRIAC BTB08-600CW

TR 52501 △ 092468679700 UEBERTRAGER  
TRANSFORMER  
TR 53500 △ 292016800200 TRAF0 DIODEN-SPLIT  
DIODE SPLIT TRANSFORMER  
TR 60500 △ 292015819700 SPERRWANDLERTRAFO  
REVERSE CONVERTER  
TRANSFORMER  
TR 60800 △ 292016249700 SPERRWANDLERTRAFO E16/5  
REVERSE CONVERTER  
TRANSFORMER E16/5

POS. NR. MATERIAL-NR. BEZEICHNUNG  
POS. NO. PART NUMBER DESCRIPTION

POS. NR. POS. NO.	ABB. FIG.	MATERIAL-NR. PART NUMBER	ANZ. QTY.	BEZEICHNUNG Ⓛ	DESCRIPTION Ⓛ
		297040111500		CHASSIS-FS-STEREO CUC 1837 DIGI 100 KEIN E-TEIL	CHASSIS TV STEREO CUC 1837 DIGI 100 NO SPARE PART
0100.000		295042622100	X	BAUSTEIN SIGNAL / ZF+TUNER	MODULE SIGNAL / IF+TUNER
0216.000		297033571100		TASTSCHALTER PROGRAMM+	KEY SWITCH PROGRAMME+
0216.000		297033571100		TASTSCHALTER PROGRAMM-	KEY SWITCH PROGRAMME-
0216.000		297033571100		TASTSCHALTER LAUTSTAERKE+	KEY SWITCH VOLUME+
0216.000		297033571100		TASTSCHALTER LAUTSTAERKE-	KEY SWITCH VOLUME-
0240.000		293033904200		KOPFHOERERBUCHSE 3,5 O.SCHALTER	HEADPHONE SOCKET 3,5 W/O SWITCH
0241.000		293031680503		CINCH-BUCHSE 3-FACH FBAS/NF L,R	CINCH SOCKET 3 FOLD FBAS/AF L,R
0400.000		295042032200	X	BAUSTEIN FEATURE	MODULE FEATURE
0451.000		297006520103		HALTER BAUSTEIN	HOLDER MODULE
1000.000		096211130206	4	SICHERUNGSHALTER SI60501/62501	FUSE HOLDER SI60501/62501
2000.000		297033910100		NETZSCHALTER S95 O. WISCHER	POWER SWITCH S95 W/O WIPER
2200.000	△	293033996601		NETZ EINBAUGERAETESTECKER	APPLIANCE PLUG W.WIRE
2400.000		293031530107	2	MONTAGECLIP T53501/60506	MOUNTING CLIP T53501/60506
2410.000		293031530208		MONTAGECLIP IC40510	MOUNTING CLIP IC40510
2420.000		293031531208	9	MONTAGECLIP D53571/53572/60506/ D61516/61521/61524/IC50510/ T50528/50529	MOUNTING CLIP D53571/53572/60506/ D61516/61521/61524/IC50510/ T50528/50529
2430.000		293031531605		MONTAGECLIP T52503	MOUNTING CLIP T52503
2440.000		293031561600		ISOLIERUNG D60019	INSULATION D60019
2445.000		293031561700		ISOLIERUNG D60021	INSULATION D60021
2450.000		293031562000	6	FOLIE WAERMELEITEND D61516/61521/ D61524/IC50510/T50528/50529	FOIL HEAT CONDUCTING D61516/61521/ D61524/IC50510/T50528/50529
2460.000		293031562100		FOLIE WAERMELEITEND D53572	FOIL HEAT CONDUCTING D53572
2470.000		293031562300		FOLIE WAERMELEITEND D53571	FOIL HEAT CONDUCTING D53571
2480.000		293031562800	2	FOLIE WAERMELEITEND D60019/60021	FOIL HEAT CONDUCTING D60019/60021
2490.000		293031563301		FOLIE WAERMELEITEND T60506	FOIL HEAT CONDUCTING T60506
				WW.=WAHLWEISE X=SIEHE GESONDERTE E-LISTE	WW.=OPTIONAL X=SEE SEPARATE PARTS LIST

POS. NR. POS. NO.	MATERIAL-NR. PART NUMBER	BEZEICHNUNG DESCRIPTION	POS. NR. POS. NO.	MATERIAL-NR. PART NUMBER	BEZEICHNUNG DESCRIPTION
C 40502	845299615000	ELKO 2200UF 20% 25V	C 61511	865006704600	KERKO HV C 100PF 20% 1KV
C 50512	845299614700	ELKO 1000UF 20% 25V	C 61512	865006704600	KERKO HV C 100PF 20% 1KV
C 50526	845299614700	ELKO 1000UF 20% 25V	C 61514	851591103800	FOKO FKP1 100PF 10% 1600V
C 53512	851591160200	FOKO FKP1 142PF 2,5% 2000V	C 61521	865006704600	KERKO HV C 100PF 20% 1KV
C 53571	851591471900	FOKO FKP1 0,012UF 3,5% 2000V	C 61524	865006704600	KERKO HV C 100PF 20% 1KV
C 60506	865006704600	KERKO HV C 100PF 20% 1KV	C 61561	865006704600	KERKO HV C 100PF 20% 1KV
C 60509	851591104000	FOKO FKP1 220PF 10% 1600V	C 61562	845209701500	ELKO #39 1000UF +50-20% 25V
C 60512	865008111100	KERKO HV C 270PF 20% 2KV	C 61563	845209701500	ELKO #39 1000UF +50-20% 25V
C 60518	851591140300	FOKO FKP1 0,01UF 5% 1250V	C 61566	865006704600	KERKO HV C 100PF 20% 1KV
C 60519	865006704600	KERKO HV C 100PF 20% 1KV	C 62501 △	851179304700	FOKO MP3/KT 0,47UF20% 275VV
C 60521	865006704600	KERKO HV C 100PF 20% 1KV	C 62502 △	851179304700	FOKO MP3/KT 0,47UF20% 275VV
C 60523	865008112500	KERKO HV C 1000PF 20% 1KV	C 62521 △	866009823400	KERKO SI 1000PF 20% 400V
C 60524	865008112500	KERKO HV C 1000PF 20% 1KV	C 62548 △	866009823800	KERKO SI 2200PF 20% 400V
C 60526	865008112500	KERKO HV C 1000PF 20% 1KV	C 62549 △	866009823400	KERKO SI 1000PF 20% 400V
C 60527	865008112500	KERKO HV C 1000PF 20% 1KV			
C 60528 △	844330315000	ELKO SNT #3 150UF 20% 450V	CD 21501	833050414800	MELF DIODE MCL4148
C 60529 △	851179301800	FOKO MP3 0,1UF 20% 275VV	CD 21502	833050414800	MELF DIODE MCL4148
C 60801	865006703100	KERKO HV C 47PF 20% 2KV	CD 21503	833050414800	MELF DIODE MCL4148
C 60802	865008112500	KERKO HV C 1000PF 20% 1KV	CD 21506	832531310300	MELF DIODE BAV103

Es gelten die Vorschriften und Sicherheitshinweise gemäß dem Service Manual "Sicherheit", Mat.-Nummer 720108000000, sowie zusätzlich die eventuell abweichenden, landesspezifischen Vorschriften!



The regulations and safety instructions shall be valid as provided by the "Safety" Service Manual, part number 720108000000, as well as the respective national deviations.

ÄNDERUNGEN VORBEHALTEN / SUBJECT TO ALTERATION

ÄNDERUNGEN VORBEHALTEN / SUBJECT TO ALTERATION

POS. NR. POS. NO.	MATERIAL-NR. PART NUMBER	BEZEICHNUNG DESCRIPTION	POS. NR. POS. NO.	MATERIAL-NR. PART NUMBER	BEZEICHNUNG DESCRIPTION	POS. NR. POS. NO.	MATERIAL-NR. PART NUMBER	BEZEICHNUNG DESCRIPTION	POS. NR. POS. NO.	MATERIAL-NR. PART NUMBER	BEZEICHNUNG DESCRIPTION
CD 21666	833050414800	MELF DIODE MCL4148	IC 60817	830546543100	IC TS431IZ-AP	R 50507	△	876642460500	MSW 0207 1,5 OHM 1%		
CD 40536	833050414800	MELF DIODE MCL4148	IC 61510	830520435700	IC LM358N	R 50508	△	876642460500	MSW 0207 1,5 OHM 1%		
CD 52503	833050414800	MELF DIODE MCL4148	IC 61535	830520497800	IC L4978	R 50526	△	870042900500	KSW NB 0207 1,5 OHM 5%		
CD 53519	833050414800	MELF DIODE MCL4148	IC 61545	830520497800	IC L4978	R 50529	△	876635705900	MSW 0414 270 OHM 5%		
CD 55503	830945504400	MELF Z-DIODE 4,3 B 0,5W	IC 61555	830520497800	IC L4978	R 52501	△	870532122100	MOW 0411 6,8 OHM 5%		
CD 55504	833050414800	MELF DIODE MCL4148	IC 84501	830546123600	IC TSOP1236	R 52503	△	873023923900	DRW SI ST7 3W 39 OHM 5%		
CD 57501	833050414800	MELF DIODE MCL4148	L 53501	810498205600	FERRITPERLE HF70 BTL 3,5X6	R 52505	△	870536000800	MOW 0617 3,9 OHM 5%		
CD 57503	833050414800	MELF DIODE MCL4148	L 53502	810498205600	FERRITPERLE HF70 BTL 3,5X6	R 52506	△	870536000800	MOW 0617 3,9 OHM 5%		
CD 57504	833050414800	MELF DIODE MCL4148	L 53503	810498205600	FERRITPERLE HF70 BTL 3,5X6	R 53508	△	870042909700	KSW NB 0207 10 KOHM 5% ST		
CD 57506	830945515000	MELF Z-DIODE 15V B 0,5W			FERRITPERLE HF70 BTL 3,5X6	R 53511	△	870522702100	MOW 0411 6,8 OHM 5%		
CD 58501	833050414800	MELF DIODE MCL4148			FERRITE BEAD	R 53516	△	873028002100	DRW SI S11 7W 6,8 OHM 5%		
CD 58504	833050414800	MELF DIODE MCL4148	L 53511	814050524900	DR A AX-GA 10UH 10%	R 53521	△	870536906300	MOW 0617 390 OHM 5% LI		
CD 58507	830945502800	MELF Z-DIODE 2,7 B 0,5W	L 53512	092401140400	DROSSEL 1,5 MH/COIL 1,5 MH	R 54501	△	873500303300	DRW 0,75W 0,33 OHM 10%		
CD 58511	833050414800	MELF DIODE MCL4148	L 53521	292031229700	LINEARITÄTSREGLER	R 55512	△	870536906500	MOW 0617 470 OHM 5% LI		
CD 58512	833050414800	MELF DIODE MCL4148			LINEARITY CONTROL	R 55514	△	870123081700	NKS 3 4,7 OHM 5%		
CD 58521	833050414800	MELF DIODE MCL4148	L 53574	092468596100	BRUECKENSPULE M.KERN	R 58501		876519810400	MSW 0207 20 KOHM 1%		
CD 58522	833050414800	MELF DIODE MCL4148			BRIDGE COIL W. CORE	R 58502		876519808600	MSW 0207 3,6 KOHM 1%		
CD 60811	833050414800	MELF DIODE MCL4148	L 55514	092458160100	O/W AUSKOPPELSPULE	R 60502		870006935600	KSW 0617 3 MOHM 2%		
CD 60812	832561034100	SMD DIODE STPS340U			E/W DECOUPLING COIL	R 60504		870006934100	KSW 0617 680 KOHM 2%		
CD 61528	832538430100	SMD Z-DIODE BZX84B30	L 60506	297017390800	DAEMPF-PERLE	R 60508		873506730100	DRW 7 15 KOHM 10%		
CD 61538	832561034100	SMD DIODE STPS340U			DAMPING BEAD	R 60512		870004903200	KSW 0411 20 OHM 5%		
CD 61548	832561034100	SMD DIODE STPS340U	L 60518	810498205700	FERRITPERLE 3,6UH	R 60528		876504414100	MSW 0411 680 KOHM 5%		
CD 61558	832561034100	SMD DIODE STPS340U			FERRITE BEAD	R 60801		876521212700	MSW 0411 180 KOHM 5%		
CD 70501	830945505100	MELF-Z DIODE 5,1 C 0,5W	L 60528	△	SPEICHERDROSSEL EF25/11 1,8MH	R 60802	△	831140107400	VDR SIOV-S07K385GS3		
CD 85513	830945505200	MELF-Z DIODE 5,1 B 0,5W			STORAGE CHOKE EF25/11 1,8MH	R 60803	△	870042904500	KSW NB 0207 68 OHM 5%		
CIC 21660	830598600000	SMD IC 74LV00	L 60812	814052499200	SIEB-DR 10UH 15%	R 60804	△	870042900100	KSW NB 0207 1 OHM 5%		
CT 21670	830100484800	SMD TRANS BC848B/ BC847B			FILTER CHOKE 10UH 15%	R 61508		879005005400	ESTR.SK10-A 22 KOHM LIN		
CT 40531	830100484800	SMD TRANS BC848B/ BC847B	L 61511	810498201400	DAEMPF-PERLE 433003038102	R 61512	△	870042904900	KSW NB 0207 100 OHM 5% ST		
CT 40591	830100484800	SMD TRANS BC848B/ BC847B	L 61514	810498201400	DAEMPF-PERLE 433003038102	R 61518		870522732100	MOW 0411 100 KOHM 10%		
CT 44515	830100484800	SMD TRANS BC848B/ BC847B	L 61521	810498201400	DAEMPF-PERLE 433003038102	R 61527	△	870536930100	MOW 0617 15 KOHM 10% LI		
CT 57506	830100484800	SMD TRANS BC848B/ BC847B	L 61524	810498201400	DAEMPF-PERLE 433003038102	R 61533		873506404900	DRW 4 100 OHM 5%		
CT 58512	830100484800	SMD TRANS BC848B/ BC847B			DAMPING BEAD	R 62501	△	876504914500	MSW SI 0414 1 MOHM 5% VDE		
CT 61585	830100484800	SMD TRANS BC848B/ BC847B	L 61527	814052499200	SIEB-DR 10UH 15%	R 62502		831100501700	NTC 4,7 OHM 30%		
CT 85505	830100385800	SMD TRANS BC858B/ BC857B	L 61538	814052499500	FILTER CHOKE 10UH 15%	R 62503	△	831140127500	VDR SIOV-S14K275E2S11M5		
CT 85510	830100385800	SMD TRANS BC858B/ BC857B	L 61548	814052105900	SIEB-DR 330UH	R 62549	△	876634915500	MSW SI 0414 2,7 MOHM 5% LI		
D 21512	830921502000	DIODE 1N4004			FILTER CHOKE 330UH	SI 52501	△	831561202700	SI LOET T315MA 250V		
D 40532	830921504500	DIODE 1N4148	L 61548	814052106800	SPEICHER-DR 59UH 2,5A	SI 60501	△	831562000300	SI 5X20 T2A L 250V		
D 50513	830951627200	DIODE BVV27/200			STORAGE CHOKE 59UH 2,5A	SI 61521	△	831562022500	SI LOET T2A 250V		
D 52506	830921502000	DIODE 1N4004	L 61549	814052499200	WW. SPEICHER-DR 67UH EF16	SI 61524	△	831562102700	SI LOET T2,5A 250V		
D 53508	830920100500	DIODE BA157			STORAGE CHOKE 67UH EF16	SI 61538	△	831561820000	SI LOET T1A 250V		
D 53519	830970900300	Z DIODE ZY 51	L 61558	814052106800	SIEB-DR 10UH 15%	SI 61561	△	831562022500	SI LOET T2A 250V		
D 53571	830920435900	DIODE BY359 1500			SPEICHER-DR 67UH EF16	SI 61566	△	831562022500	SI LOET T2A 250V		
D 53572	830920423000	DIODE BY 229-600	L 61558	814052105900	STORAGE CHOKE 67UH EF16	SI 62501	△	831562250300	SI 5X20 T3,15A H 250V		
D 54501	830920100500	DIODE BA157			WW. SPEICHER-DR 59UH 2,5A	T 21511		830340129900	TRANS.BF299 G/PBF259		
D 55512	830972033300	Z DIODE 33 C 0,5W	L 61558	814052106700	STORAGE CHOKE 59UH 2,5A	T 50528		830221054400	TRANS BD544B/ BD538		
D 60019	830919780700	DIODE STT806D			STORAGE CHOKE EF16 67UH 2,5A	T 50529		830221054300	TRANS BD543B/ BD537		
D 60021	830919780700	DIODE STT806D	L 61561	810498201400	DAEMPF-PERLE 433003038102	T 52503		830221068200	TRANS.BD 679A		
D 60506	830982088000	DIODE MUR 880 WW.BYT 08 P	L 61562	814050506500	DAMPING BEAD	T 53501		830262533100	TRANS 2SC5331		
D 60512	830951675400	DIODE BYT53B	L 61566	810498201400	DR A AX-GA 47UH 5%	T 60506		830263829900	TRANS 2SK2699		
D 60523	830856038400	GLR.SKB380C1500			DAEMPF-PERLE 433003038102	TC 22503	△	831001000800	TRIAC BTB08-600CW		
D 61503	830972009900	Z DIODE 10 B 0,5W	L 61567	814050506500	DAMPING BEAD	TR 52501	△	092468679700	UEBERTRAGER TRANSFORMER		
D 61511	830951603800	DIODE BYV38	L 62501	△	DR A AX-GA 47UH 5%	TR 53500	△	292016800300	TRAFO DIODEN-SPLIT DIODE SPLIT TRANSFORMER		
D 61512	830951603800	DIODE BYV38			ENTSTOER-DR 2X22MH	TR 60500	△	292015819700	SPERRWANDLERTRAFO REVERSE CONVERTER TRANSFORMER		
D 61516	830951679800	DIODE BYT 08 P-1000	L 62527	814052540600	INTERFERENCE CHOKE 2X22MH	TR 60800	△	292016249700	SPERRWANDLERTRAFO REVERSE CONVERTER TRANSFORMER		
D 61521	830919682000	DIODE STPR820D			BREITBAND-DR WIDE-BAND CHOKE						
D 61524	830919682000	DIODE STPR820D	OK 22505	△	OPTOKOPPLER IL4216-X001						
D 61533	830920100500	DIODE BA157	OK 22505	△	WW. OPTOKOPPLER TL3063						
D 61561	△	830951717200	OK 60531	△	OPTOKOPPLER CNY17F1						
D 61566	△	830951717200	OK 60546	△	OPTOKOPPLER CNY17F1						
D 85501	830998411600	LE-DIODE L-115WEGW	OK 60805	△	OPTOKOPPLER SFH615A-2						
IC 40510	830536729700	IC TDA7297	R 21523	△	870532122100	MOW 0411 6,8 OHM 5%					
IC 50510	830512597900	IC STV9379A	R 22501	△	831120001600	PTC DUO T251-A80-A10					
IC 55510	830533814500	IC TDA8145	R 22504		870004912100	KSW 0411 100 KOHM 5%					
IC 58510	830520439300	IC LM393P	R 22506	△	870022905700	KSW NB 0207 220 OHM 5%					
IC 60510	830533464600	IC TDA16846	R 40502	△	873229600900	DRW 6,5 2,2 OHM 10%					
IC 60801	830547025300	IC TNY253									

ÄNDERUNGEN VORBEHALTEN / SUBJECT TO ALTERATION

Es gelten die Vorschriften und Sicherheitshinweise gemäß dem Service Manual "Sicherheit", Mat.-Nummer 720108000000, sowie zusätzlich die eventuell abweichenden, landesspezifischen Vorschriften!



The regulations and safety instructions shall be valid as provided by the "Safety" Service Manual, part number 720108000000, as well as the respective national deviations.

ÄNDERUNGEN VORBEHALTEN / SUBJECT TO ALTERATION



POS. NR.	MATERIAL-NR.	BEZEICHNUNG
POS. NO.	PART NUMBER	DESCRIPTION

R 53516	△ 873028002100	DRW SI S11 7W 6,8 OHM 5%
R 53521	△ 870536906300	MOW 0617 390 OHM 5%
R 54501	△ 873500303300	DRW 0,75W 0,33 OHM 10%
R 55512	△ 870536906500	MOW 0617 470 OHM 5%
R 55514	△ 870123081700	NKS 3 4,7 OHM 5%
R 58501	876519810400	MSW 0207 20 KOHM 1%
R 60502	870006935600	KSW 0617 3 MOHM 2%
R 60504	870006934100	KSW 0617 680 KOHM 2%
R 60508	873506730100	DRW 7 15 KOHM 10%
R 60512	870004903200	KSW 0411 20 OHM 5%
R 60528	876504414100	MSW 0411 680 KOHM 5%
R 60801	876504412700	MSW 0414 180 KOHM 5%
R 61508	879005005400	ESTR.SK10-A 22 KOHM LIN
R 61512	△ 870042904900	KSW NB 0207 100 OHM 5%
R 61518	870522732100	MOW 0411 100 KOHM 10%
R 61527	△ 870536930100	MOW 0617 15 KOHM 10%
R 61533	873506404900	DRW 4 100 OHM 5%
R 61572	879005004000	ESTR.SK10-A 2,2 KOHM LIN
R 62501	△ 876504914500	MSW SI 0414 1 MOHM 5% VDE
R 62502	831100501700	NTC 4,7 OHM 30%
R 62549	△ 876634915500	MSW SI 0414 2,7 MOHM 5%

SI 52501	△ 831561202700	SI LOET T315MA 250V
SI 60501	△ 831562000300	SI 5X20 T2A L 250V
SI 60801	△ 831560700200	SI 5X20 T100MA L 250V
SI 61521	△ 831562022500	SI LOET T2A 250V
SI 61524	△ 831562102700	SI LOET T2,5A 250V
SI 61538	△ 831561820000	SI LOET T1A 250V
SI 61561	△ 831562022500	SI LOET T2A 250V
SI 61566	△ 831562022500	SI LOET T2A 250V
SI 62501	△ 831562250300	SI 5X20 T3,15A H 250V

T 21511	830340129900	TRANS.BF299 G PBF259
T 50528	830221054400	TRANS.BD544B/BD538
T 50529	830221054300	TRANS.BD543B/BD537
T 52503	830221068200	TRANS.BD 679A
T 53501	830262533100	TRANS.2SC5331
T 60506	830263829900	TRANS.2SK2699
T 61505	830225425400	TRANS.FET BSN254A

TC 22503 △ 831001000800 TRIAC BTB08-600CW

TR 52501	△ 092468679700	UEBERTRAGER TRANSFORMER
TR 53500	△ 292016800300	TRAFO DIODEN-SPLIT TRANSFORMER DIODES SPLIT
TR 60500	△ 292015819700	SPERRWANDLERTRAFO B.O.-TYPE CONVERTER TRANSFORMER
TR 60800	△ 292016249700	SPERRWANDLERTRAFO B.O.-TYPE CONVERTER TRANSFORMER

Es gelten die Vorschriften und Sicherheitshinweise gemäß dem Service Manual "Sicherheit", Mat.-Nummer 720108000000, sowie zusätzlich die eventuell abweichenden, landesspezifischen Vorschriften!



The regulations and safety instructions shall be valid as provided by the "Safety" Service Manual, part number 720108000000, as well as the respective national deviations.

ÄNDERUNGEN VORBEHALTEN / SUBJECT TO ALTERATION

POS. NR.	MATERIAL-NR.	BEZEICHNUNG
POS. NO.	PART NUMBER	DESCRIPTION

## Ersatzteilliste Spare Parts List

### 5 / 2001

## CHASSIS-FS-STEREO DIGI 100 CUC 1837 CHASSIS TV STEREO DIGI 100 CUC 1837

MATERIAL-NR. / PART NO.: 297040114100

POS. NR.	ABB.	MATERIAL-NR.	ANZ.	BEZEICHNUNG	DESCRIPTION
POS. NO.	FIG.	PART NUMBER	QTY.	①	②
		297040114100		CHASSIS-FS-STEREO DIGI 100 CUC 1837 KEIN E-TEIL	CHASSIS TV STEREO DIGI 100 CUC 1837 NO SPARE PART
0100.000		295042022100	X	BAUSTEIN SIGNAL/ZF+TUNER	MODULE SIGNAL/IF+TUNER
0215.000		295017660102		TASTENSATZ PROGRAMM/LAUTSTAERKE	KEY SET PROGRAMME/VOLUME
0216.000		297033571100		TASTSCHALTER PROGRAMM +	KEY SWITCH PROGRAMME +
0216.000		297033571100		TASTSCHALTER PROGRAMM -	KEY SWITCH PROGRAMME -
0216.000		297033571100		TASTSCHALTER LAUTSTAERKE +	KEY SWITCH VOLUME +
0216.000		297033571100		TASTSCHALTER LAUTSTAERKE -	KEY SWITCH VOLUME -
0240.000		293033904200		KOPFHOERERBUCHSE 3,5mm O.SCHALTER	HEADPHONE SOCKET 3,5mm W/O SWITCH
0241.000		293031680503		CINCH-BUCHSE 3-FACH FBAS/NF L,R	CINCH SOCKET 3 FOLD FBAS/AF L,R
0400.000		295042032200	X	BAUSTEIN FEATURE	MODULE FEATURE
0450.000		297006520103		HALTER BAUSTEIN	HOLDER MODULE
1000.000		096211130206	4	SICHERUNGSHALTER SI60501/62501	FUSE HOLDER SI60501/62501
2000.000		297033910100		NETZSCHALTER O.WISCHER	POWER SWITCH W/O WIPER
2200.000		293033996601		NETZ EINBAUGERAETESTECKER	APPLIANCE PLUG
2400.000		293031530107	2	MONTAGECLIP T53501/60506	MOUNTING CLIP T53501/60506
2410.000		293031530208		MONTAGECLIP IC 40510	MOUNTING CLIP IC40510
2430.000		293031531208	9	MONTAGECLIP D53571/53572/60506/61516 D61521/61524/IC50510/T50528/50529	MOUNTING CLIP D53571/53572/60506/61516 D61521/61524/IC50510/T50528/50529
2440.000		293031531605		MONTAGECLIP T52503	MOUNTING CLIP T52503
2450.000		293031561600	2	ISOLIERUNG D60019	ISOLATING D60019
2460.000		293031561700		ISOLIERUNG D60021	ISOLATION D60021
2465.000		293031561800		FOLIE WAERMELEITEND D60506	FOIL HEAT CONDUCTING D60506
2470.000		293031562000	6	FOLIE WAERMELEITEND D61516/61521/ 61524/IC50510/T50528/50529	FOIL HEAT CONDUCTING D61516/61521/ 61524/IC50510/T50528/50529
2480.000		293031562100		FOLIE WAERMELEITEND D53572	FOIL HEAT CONDUCTING D53572
2485.000		293031562300		FOLIE WAERMELEITEND D53571	FOIL HEAT CONDUCTING D53571
2490.000		293031562800	2	FOLIE WAERMELEITEND D60019/60021	FOIL HEAT CONDUCTING D60019/60021
				X = SIEHE GESONDERTE E-LISTE WW. = WAHLWEISE	X = SEE SEPARATE PARTS LIST WW. = OPTIONAL

POS. NR.	MATERIAL-NR.	BEZEICHNUNG	POS. NR.	MATERIAL-NR.	BEZEICHNUNG
POS. NO.	PART NUMBER	DESCRIPTION	POS. NO.	PART NUMBER	DESCRIPTION

C 40502	845299615000	ELKO 2200UF 20% 25V	C 60801	865006703100	KERKO HV C 47PF 20% 2KV
C 50512	845299614700	ELKO 1000UF 20% 25V	C 60802	865008112500	KERKO HV C 1000PF 20% 1KV
C 50526	845299614700	ELKO 1000UF 20% 25V	C 61511	865006704600	KERKO HV C 100PF 20% 1KV
C 53512	851591160200	FOKO FKP1 142PF 2,5% 2000V	C 61512	865006704600	KERKO HV C 100PF 20% 1KV
C 53571	851591471700	FOKO FKP1 0,01 1UF 3,5% 2000V	C 61514	851591103800	FOKO FKP1 100PF 10% 1600V
C 60506	865006704600	KERKO HV C 100PF 20% 1KV	C 61521	865006704600	KERKO HV C 100PF 20% 1KV
C 60509	851591104000	FOKO FKP1 220PF 10% 1600V	C 61522	845209705500	ELKO #16 600/680UF 63V
C 60512	865008111100	KERKO HV C 270PF 20% 2KV	C 61524	865006704600	KERKO HV C 100PF 20% 1KV
C 60518	851591140300	FOKO FKP1 0,01UF 5% 1250V	C 61561	865006704600	KERKO HV C 100PF 20% 1KV
C 60519	865006704600	KERKO HV C 100PF 20% 1KV	C 61562	845209701500	ELKO #39 1000UF +50-20% 25V
C 60521	865006704600	KERKO HV C 100PF 20% 1KV	C 61563	845209701500	ELKO #39 1000UF +50-20% 25V
C 60523	865008112500	KERKO HV C 1000PF 20% 1KV	C 61566	865006704600	KERKO HV C 100PF 20% 1KV
C 60524	865008112500	KERKO HV C 1000PF 20% 1KV	C 62501	△ 851179304700	FOKO MP3 0,47UF20% 250V
C 60526	865008112500	KERKO HV C 1000PF 20% 1KV	C 62502	△ 851179304700	FOKO MP3 0,47UF20% 250V
C 60527	865008112500	KERKO HV C 1000PF 20% 1KV	C 62521	△ 866009823400	KERKO SI 1000PF 20% 400V
C 60528	△ 844330315000	ELKO SNT #3 150UF 20% 450V	C 62548	△ 866009823800	KERKO SI 2200PF 20% 400V
C 60529	△ 851179301800	MP3 0,1UF 20% 250V	C 62549	△ 866009823400	KERKO SI 1000PF 20% 400V

ÄNDERUNGEN VORBEHALTEN / SUBJECT TO ALTERATION





POS. NR. POS. NO.	MATERIAL-NR. PART NUMBER	BEZEICHNUNG DESCRIPTION
----------------------	-----------------------------	----------------------------

R 50507	△ 876642460500	MSW 0207 1,5 OHM 1%
R 50508	△ 876642460500	MSW 0207 1,5 OHM 1%
R 50526	△ 870042900500	KSW NB 0207 1,5 OHM 5%
R 50529	△ 876635705900	MSW 0414 2,70 OHM 5%
R 52501	△ 870532122300	MOW 0411 8,2 OHM 5%
R 52503	△ 873023923900	DRW SI ST17 3W 39 OHM 5%
R 52505	△ 870536901700	MOW 0617 4,7 OHM 5% LI
R 52506	△ 870536901700	MOW 0617 4,7 OHM 5% LI
R 53508	△ 870042909700	KSW NB 0207 10 KOHM 5% ST
R 53511	△ 870522702100	MOW 0411 6,8 OHM 5%
R 53516	△ 873028002100	DRW SI S11 7W 6,8 OHM 5%
R 53521	△ 870536906300	MOW 0617 390 OHM 5% LI
R 54501	△ 873500303300	DRW 0,75W 0,33 OHM 10%
R 55512	△ 870536926900	MOW 0617 680 OHM 10% LI
R 55514	△ 870123081700	NKS 3 4,7 OHM 5%
R 60502	△ 870006935600	KSW 0617 3 MOHM 2%
R 60504	△ 870006934100	KSW 0617 680 KOHM 2%
R 60508	△ 873506730100	DRW 7 15 KOHM 10% STANDB.
R 60801	△ 876521212700	MSW 0411 180 KOHM 5%
R 60802	△ 831140107400	VDR SIOV-S07K385GS3
R 60803	△ 870042904500	KSW NB 0207 68 OHM 5%
R 60806	△ 876504915300	MSW SI 0414 2,2 MOHM VDE
R 61508	△ 879005005400	ESTR.SK10-A 22 KOHM LIN
R 61512	△ 870042904900	KSW NB 0207 100 OHM 5% ST
R 61518	△ 870522732100	MOW 0411 100 KOHM 10%
R 61527	△ 870536930100	MOW 0617 15 KOHM 10% LI
R 61533	△ 873506404900	DRW 4 100 OHM 5% STANDB.
R 62501	△ 876504914500	MSW SI 0414 1 MOHM 5% VDE
R 62502	△ 831100501700	NTC 4,7 OHM 30% S237/4,7M
R 62503	△ 831140127500	VDR SIOV-S14K275E2S11M5
R 62549	△ 876634915500	MSW SI 0414 2,7 MOHM 5% LI

SI 52501	△ 831561202700	SI LOET T315MA 250V
SI 60501	△ 831562000300	SI 5X20 T2A L 250V
SI 61521	△ 831562022500	SI LOET T2A 250V
SI 61524	△ 831562102700	SI LOET T2,5A 250V
SI 61538	△ 831561820000	SI LOET T1A 250V
SI 61561	△ 831562022500	SI LOET T2A 250V
SI 61566	△ 831562022500	SI LOET T2A 250V
SI 62501	△ 831562250300	SI 5X20 T3,15A H 250V

T 21511	830340129900	TRANS.BF299 G ITT/PBF259 RS
T 50528	830221054400	TRANS BD544B TID/ BD538B
T 50529	830221054300	TRANS BD543B TID/ BD537B
T 52503	830221068200	TRANS.BD 679A
T 53501	830262533100	TRANS 2SC5331
T 60506	830263829800	TRANS 2SK2699(LBGRUN)

TC 22503	△ 831001000800	TRIAC BTB08-600CW F17
----------	----------------	-----------------------

TR 52501	△ 092468679700	UEBERTRAGER VOGT TRANSFORMER
----------	----------------	------------------------------

TR 53500	△ 292016800401	TRAFODIODEN-SPLIT TRANSFORMER DIODES SPLIT
----------	----------------	--

TR 60500	△ 292015809700	SPERRWANDLERTRAFO
TR 60801	△ 292016299701	SPERRWANDLERTRAFO CONVERTER TRANSFORMER

Es gelten die Vorschriften und Sicherheitshinweise gemäß dem Service Manual "Sicherheit", Mat.-Nummer 720108000000, sowie zusätzlich die eventuell abweichenden, landesspezifischen Vorschriften!



The regulations and safety instructions shall be valid as provided by the "Safety" Service Manual, part number 720108000000, as well as the respective national deviations.

ÄNDERUNGEN VORBEHALTEN / SUBJECT TO ALTERATION

## Ersatzteilliste Spare Parts List

**11 / 2001**

**CHASSIS-FS-STEREO DIGI 100 CUC 1837  
CHASSIS TV STEREO DIGI 100 CUC 1837**

MATERIAL-NR. / PART NO.: 297040190900

POS. NR. POS. NO.	ABB. FIG.	MATERIAL-NR. PART NUMBER	ANZ. QTY.	BEZEICHNUNG Ⓚ	DESCRIPTION Ⓚ
		297040190900		CHASSIS-FS-STEREO DIGI 100 CUC 1837 KEIN E-TEIL	CHASSIS TV STEREO DIGI 100 CUC 1837 NO SPARE PART
0100.000		295042622400	X	BAUSTEIN SIGNAL/ZF+TUNER	MODULE SIGNAL/IF-TUNER
0216.000		297033571100		TASTSCHALTER PROGRAMM +	KEY SWITCH PROGRAMM +
0216.000		297033571100		TASTSCHALTER PROGRAMM -	KEY SWITCH PROGRAMME -
0216.000		297033571100		TASTSCHALTER LAUTSTÄRKE +	KEY SWITCH VOLUME +
0216.000		297033571100		TASTSCHALTER LAUTSTÄRKE -	KEY SWITCH VOLUME -
0240.000		293033904200		KOPFHOERERBUCHSE 3,5mm O.SCHALTER	HEADPHONE SOCKET 3,5mm W/O SWITCH
0241.000		293031680503		CINCH-BUCHSE 3-FACH FBAS/NF L,R	CINCH SOCKET 3 FOLD FBAS AF L,R
0450.000		297006520103		HALTER BAUSTEIN	HOLDER MODULE
0500.000		295042032200	X	BAUSTEIN FEATURE	MODULE FEATURE
1000.000	△	096211130206	4	SICHERUNGSHALTER SI60501/62501	FUSE HOLDER SI60501/62501
2000.000	△	297033910100		NETZSCHALTER O.WISCHER	POWER SWITCH W/O WIPER
2200.000	△	293033996601		NETZ EINBAUGERAETESTECKER	APPLIANCE PLUG
2310.000	△	292017119700		SPEICHERDROSSEL	STORAGE CHOKER
2400.000		293031530107	2	MONTAGECLIP T53501/60506	MOUNTING CLIP T53501/60506
2410.000		293031530208		MONTAGECLIP IC40510	MOUNTING CLIP IC40510
2420.000		293031531208	9	MONTAGECLIP D53571/53572/60506	MOUNTING CLIP D53571/53572/60506
				D61516/61521/61524/IC50510 T50528/50529	D61516/61521/61524/IC50510 T50528/50529
2430.000		293031531605		MONTAGECLIP T52503	MOUNTING CLIP T50503
2440.000		293031561600		ISOLIERUNG D60019	INSULATING D60019
2445.000		293031561700		ISOLIERUNG D60021	INSULATION D60021
2450.000		293031561800		FOLIE WAERMELEITEND D60506	FOIL HEAT CONDUCTING D60506
2460.000		293031562000	6	FOLIE WAERMELEITEND D61516/61521 D61524/IC50510/T50528/50529	FOIL HEAT CONDUCTING D61516/61521 D61524/IC50510/T50528/50529
2470.000		293031562100		FOLIE WAERMELEITEND D53572	FOIL HEAT CONDUCTING D53572
2480.000		293031562300		FOLIE WAERMELEITEND D53571	FOIL HEAT CONDUCTING D53571
2490.000		293031562800	2	FOLIE WAERMELEITEND D60019/60021	FOIL HEAT CONDUCTING D60019/60021
				X = SIEHE GESONDERTE E-LISTE WW. = WAHLWEISE	X = SEE SEPARATE PARTS LIST WW. = OPTIONAL

POS. NR. POS. NO.	MATERIAL-NR. PART NUMBER	BEZEICHNUNG DESCRIPTION
----------------------	-----------------------------	----------------------------

C 40502	845299615000	ELKO 2200UF 20% 25V
C 50512	845299614700	ELKO 1000UF 20% 25V
C 50526	845299614700	ELKO 1000UF 20% 25V
C 53512	851591160200	FOKO FKP1 142PF 2,5% 2000V
C 60506	865006704600	KERKO HV C 100PF 20% 1KV
C 60509	851591104000	FOKO FKP1 220PF 10% 1600V
C 60512	865008111100	KERKO HV C 270PF 20% 2KV
C 60518	851591140300	FOKO FKP1 0,01UF 5% 1250V
C 60519	865006704600	KERKO HV C 100PF 20% 1KV
C 60521	865006704600	KERKO HV C 100PF 20% 1KV
C 60523	865008112500	KERKO HV C 1000PF 20% 1KV
C 60524	865008112500	KERKO HV C 1000PF 20% 1KV
C 60526	865008112500	KERKO HV C 1000PF 20% 1KV
C 60527	865008112500	KERKO HV C 1000PF 20% 1KV
C 60528	△ 844330315000	ELKO SNT #3 150UF 20% 450V

POS. NR. POS. NO.	MATERIAL-NR. PART NUMBER	BEZEICHNUNG DESCRIPTION
----------------------	-----------------------------	----------------------------

C 60529	△ 851179301800	FOKO MP3 0,1UF 20% 275V
C 60801	865006703100	KERKO HV C 47PF 20% 2KV
C 60802	865008112500	KERKO HV C 1000PF 20% 1KV
C 61511	865006704600	KERKO HV C 100PF 20% 1KV
C 61512	865006704600	KERKO HV C 100PF 20% 1KV
C 61514	851591103800	FOKO FKP1 100PF 10% 1600V
C 61521	865006704600	KERKO HV C 100PF 20% 1KV
C 61522	845209705500	ELKO #16 600/680UF 63V
C 61524	865006704600	KERKO HV C 100PF 20% 1KV
C 61561	865006704600	KERKO HV C 100PF 20% 1KV
C 61562	845209701500	ELKO #39 1000UF +50-20% 25V
C 61563	845209701500	ELKO #39 1000UF +50-20% 25V
C 61566	865006704600	KERKO HV C 100PF 20% 1KV
C 62501	△ 851179304700	FOKO MP3/KT 0,47UF20% 275V
C 62502	△ 851179304700	FOKO MP3/KT 0,47UF20% 275V
C 62521	△ 866009823400	KERKO SI 1000PF 20% 400V

ÄNDERUNGEN VORBEHALTEN / SUBJECT TO ALTERATION





POS. NR. MATERIAL-NR. BEZEICHNUNG  
POS. NO. PART NUMBER DESCRIPTION

OK 22505△ 830600024200 OPTOKOPPLER  
OK 22505△ 830600036200 OPTOKOPPLER  
OK 60531△ 830600001200 OPTOKOPPLER  
OK 60546△ 830600001200 OPTOKOPPLER  
OK 60805△ 830600061500 OPTOKOPPLER  
OPTO COUPLER

R 21512 870000754900 KSW 0207 1,5 MOHM 5%  
R 21523 △ 870532122100 MOW 0411 6,8 OHM 5%  
R 22501 △ 831120001600 PTC DUO T251-A80-A10  
R 22506 △ 870022905700 KSW NB 0207 220 OHM 5%  
R 40502 △ 873229600900 DRW 6,5 2,2 OHM 10%  
R 50526 △ 870042900500 KSW NB 0207 1,5 OHM 5%  
R 50529 △ 876635705900 MSW 0414 270 OHM 5%  
R 52501 △ 870532122100 MOW 0411 6,8 OHM 5%  
R 52503 △ 873023923900 DRW SI ST7 3W 39 OHM 5%  
R 52505 △ 870536000800 MOW 0617 3,9 OHM 5%  
R 52506 △ 870536000800 MOW 0617 3,9 OHM 5%  
R 53508 △ 870042909700 KSW NB 0207 10 KOHM 5%  
R 53516 △ 873028002100 DRW SI S11 7W 6,8 OHM 5%  
R 53521 △ 870536906300 MOW 0617 390 OHM 5%  
R 54501 △ 873500303300 DRW 0,75W 0,33 OHM 10%  
R 55512 △ 870536926900 MOW 0617 680 OHM 10%  
R 55514 △ 870123081700 NKS 3 4,7 OHM 5%  
R 58501 876519810400 MSW 0207 20 KOHM 1%  
R 58502 876519808600 MSW 0207 3,6 KOHM 1%  
R 58524 870001134500 KSW 0204 1 MOHM 5%  
R 60502 870006935600 KSW 0617 3 MOHM 2%  
R 60508 873506730100 DRW 7 15 KOHM 10%  
R 60512 870000743200 KSW 0207 20 OHM 5%  
R 60802 △ 831140107400 VDR SIOV-S07K385GS3  
R 60803 △ 870042904500 KSW NB 0207 68 OHM 5%  
R 60806 △ 876504915300 MSW SJ 0414 2,2 MOHM  
R 61508 879005005400 ESTR.SK10-A 22 KOHM  
R 61512 △ 870042904900 KSW NB 0207 100 OHM 5%  
R 61527 △ 870536930100 MOW 0617 15 KOHM 10%  
R 61533 873506404900 DRW 4 100 OHM 5%  
R 62501 △ 876504914500 MSW SJ 0414 1 MOHM 5%  
R 62502 831100501700 NTC 4,7 OHM 30%  
R 62503 △ 831140127500 VDR SIOV-S14K275E2S11M5  
R 62549 △ 876634915500 MSW SJ 0414 2,7 MOHM 5%

SI 52501 △ 831561202700 SI LOET T315MA 250V  
SI 60501 △ 831562000300 SI 5X20 T2A L250V  
SI 61521 △ 831562022500 SI LOET T2A 250V  
SI 61524 △ 831562102700 SI LOET T2,5A 250V  
SI 61538 △ 831561820000 SI LOET T1A 250V  
SI 61561 △ 831562022500 SI LOET T2A 250V  
SI 61566 △ 831562022500 SI LOET T2A 250V  
SI 62501 △ 831562250300 SI 5X20 T3,15A H250V

T 21511 830340129900 TRANS BF299G  
T 50528 830221054400 TRANS BD544B  
T 50529 830221054300 TRANS BD543B  
T 52503 830221068200 TRANS BD679A  
T 53501 830262533100 TRANS 2SC5331  
T 60506 830263829900 TRANS 2SK2699

TC 22503△ 831001000800 TRIAC BTB08-600CW

TR 52501△ 092468679700 UEERTRAGER VOGT

TRAFORMER DRIVER  
TR 53500△ 292016800300 TRAFODIODEN-SPLIT  
TRANSFORMER DIODE SPLIT

POS. NR. MATERIAL-NR. BEZEICHNUNG  
POS. NO. PART NUMBER DESCRIPTION

TR 60500△ 292015819700 SPERRWANDLERTRAFO  
B.O.TYPE CONVERTER  
TRANSFORMER  
TR 60801△ 292016299701 SPERRWANDLERTRAFO STAND BY  
B.O.TYPE CONVERTER  
TRANSFORMER STAND BY

### Ersatzteilliste Spare Parts List

#### 4 / 2002

#### CHASSIS-FS-STEREO CUC 1837 DIGI 100 CHASSIS TV STEREO CUC 1837 DIGI 100

MATERIAL-NR. / PART NO. : 297040191600

POS. NR. POS. NO.	ABB. FIG.	MATERIAL-NR. PART NUMBER	ANZ. QTY.	BEZEICHNUNG (D)	DESCRIPTION (GB)
		297040191600		CHASSIS-FS-STEREO CUC 1837 DIGI 100 KEIN E-TEIL	CHASSIS TV STEREO CUC 1837 DIGI 100 NO SPARE PART
0100.000		295042022400	X	BAUSTEIN SIGNAL / ZF-TUNER	MODULE SIGNAL / IF TUNER
0215.000		295017660102		TASTEN-SATZ PROGRAMM/LAUTSTAERKE	KEYS SET PROGRAMME/VOLUME
0216.000		297033571100		TASTSCHALTER PROGRAMM+	KEY SWITCH PROGRAMME+
0216.000		297033571100		TASTSCHALTER PROGRAMM-	KEY SWITCH PROGRAMME-
0216.000		297033571100		TASTSCHALTER LAUTSTAERKE+	KEY SWITCH VOLUME+
0216.000		297033571100		TASTSCHALTER LAUTSTAERKE-	KEY SWITCH VOLUME-
0240.000		293033904200		KOPFHUERBUCHSE 3,5 O.SCHALTER	HEADPHONE SOCKET 3,5 W/O SWITCH
0241.000		293031680503		CINCH-BUCHSE 3-FACH FBAS/NF L,R	CINCH SOCKET 3 FOLD FBAS/AF L,R
0400.000		295042032200	X	BAUSTEIN FEATURE	MODULE FEATURE
0451.000		297006521102		HALTER BAUSTEIN	HOLDER MODULE
1000.000		096211130206	4	SICHERUNGSHALTER SI60501/62501	FUSE HOLDER SI60501/62501
2000.000	△	297033910100		NETZSCHALTER O.WISCHER	POWER SWITCH W/O WIPE
2200.000	△	293033994802		NETZ EINBAUGERAETESTECKER	APPLIANCE COUPLER W.CABLE
2400.000		293031530107	2	MONTAGECLIP T53501/60506	MOUNTING CLIP T53501/60506
2410.000		293031530208		MONTAGECLIP IC40510	MOUNTING CLIP IC40510
2420.000		293031531208	9	MONTAGECLIP D53571/53572/60506/ D61524/IC50510/T50528/50529	MOUNTING CLIP D53571/53572/60506/ D61516/61521/61524/IC50510/ T50528/50529
2430.000		293031531605		MONTAGECLIP T52503	MOUNTING CLIP T52503
2440.000		293031561600		ISOLIERUNG D60019	INSULATION D60019
2445.000		293031561700		ISOLIERUNG D60021	INSULATION D60021
2450.000		293031562000	6	FOLIE WAERMELEITEND D61516/61521/ D61524/IC50510/T50528/50529	FOIL HEAT CONDUCTING D61516/61521/ D61524/IC50510/T50528/50529
2460.000		293031562100		FOLIE WAERMELEITEND D53572	FOIL HEAT CONDUCTING D53572
2470.000		293031562300		FOLIE WAERMELEITEND D53571	FOIL HEAT CONDUCTING D53571
2480.000		293031562800	2	FOLIE WAERMELEITEND D60019/60021	FOIL HEAT CONDUCTING D60019/60021
2490.000		293031563301		FOLIE WAERMELEITEND D60506	FOIL HEAT CONDUCTING D60506
				WW.=WAHLWEISE X=SIEHE GESONDERTE E-LISTE	WW.=OPTIONAL X=SEE SEPARATE PARTS LIST

POS. NR. POS. NO.	MATERIAL-NR. PART NUMBER	BEZEICHNUNG DESCRIPTION
C 40502	845299615000	ELKO 2200UF 20% 25V
C 50512	845299614700	ELKO 1000UF 20% 25V
C 50526	845299614700	ELKO 1000UF 20% 25V
C 53512	851591160200	FOKO FKP1 142PF 2,5% 2000V
C 53571	851591471700	FOKO FKP1 0,011UF 3,5% 2000V
C 60506	865006704600	KERKO HV C 100PF 20% 1KV
C 60509	851591104000	FOKO FKP1 220PF 10% 1600V
C 60512	865008111000	KERKO HV C 270PF 20% 2KV
C 60518	851591140300	FOKO FKP1 0,011UF 5% 1250V
C 60519	865006704600	KERKO HV C 100PF 20% 1KV
C 60521	865006704600	KERKO HV C 100PF 20% 1KV
C 60523	865008112500	KERKO HV C 1000PF 20% 1KV
C 60524	865008112500	KERKO HV C 1000PF 20% 1KV
C 60526	865008112500	KERKO HV C 1000PF 20% 1KV
C 60527	865008112500	KERKO HV C 1000PF 20% 1KV
C 60528 △	844330315000	ELKO SNT #3 150UF 20% 450V
C 60529 △	851179301800	FOKO MP3 C,1UF 20% 275VW
C 60801	865006703100	KERKO HV C 47PF 20% 2KV

POS. NR. POS. NO.	MATERIAL-NR. PART NUMBER	BEZEICHNUNG DESCRIPTION
C 60802	865008112500	KERKO HV C 1000PF 20% 1KV
C 61511	865006704600	KERKO HV C 100PF 20% 1KV
C 61512	865006704600	KERKO HV C 100PF 20% 1KV
C 61514	851591103800	FOKO FKP1 100PF 10% 1600V
C 61521	865006704600	KERKO HV C 100PF 20% 1KV
C 61524	865006704600	KERKO HV C 100PF 20% 1KV
C 61561	865006704600	KERKO HV C 100PF 20% 1KV
C 61562	845209701500	ELKO #39 1000UF +50-20% 25V
C 61563	845209701500	ELKO #39 1000UF +50-20% 25V
C 61566	865006704600	KERKO HV C 100PF 20% 1KV
C 62501 △	851179304700	FOKO MP3/KT 0,47UF20% 275VW
C 62502 △	851179304700	FOKO MP3/KT 0,47UF20% 275VW
C 62521 △	866009823400	KERKO SI 1000PF 20% 400V
C 62548 △	866009823800	KERKO SI 2200PF 20% 400V
C 62549 △	866009823400	KERKO SI 1000PF 20% 400V
CD 21501	833050414800	MELF DIODE MCL4148
CD 21502	833050414800	MELF DIODE MCL4148

Es gelten die Vorschriften und Sicherheitshinweise gemäß dem Service Manual "Sicherheit", Mat.-Nummer 720108000000, sowie zusätzlich die eventuell abweichenden, landesspezifischen Vorschriften!



The regulations and safety instructions shall be valid as provided by the "Safety" Service Manual, part number 720108000000, as well as the respective national deviations.

ÄNDERUNGEN VORBEHALTEN / SUBJECT TO ALTERATION

ÄNDERUNGEN VORBEHALTEN / SUBJECT TO ALTERATION



CHASSIS-FS-STEREO CUC 1837 DIGI 100  
CHASSIS TV STEREO CUC 1837 DIGI 100

MATERIAL-NR. / PART NO.: 297040191700

Table with 5 columns: POS. NR., ABB., MATERIAL-NR., ANZ., BEZEICHNUNG and DESCRIPTION. Includes parts like BAUSTEIN SIGNAL, TASTSCHALTER PROGRAMM, and various diodes and transistors.

WW.=WAHLWEISE  
X=SIEHE GESONDERTE E-LISTE  
WW.=OPTIONAL  
X=SEE SEPARATE PARTS LIST

Table with 3 columns: POS. NR., MATERIAL-NR., BEZEICHNUNG and POS. NO., PART NUMBER, DESCRIPTION. Includes parts like MELF DIODE MCL4148, MELF Z-DIODE, and SMD TRANS.

Table with 3 columns: POS. NR., MATERIAL-NR., BEZEICHNUNG and POS. NO., PART NUMBER, DESCRIPTION. Includes parts like IC STV9379A, IC TDA8145, IC LM393P, and various integrated circuits.

POS. NR. POS. NO.	MATERIAL-NR. PART NUMBER	BEZEICHNUNG DESCRIPTION	POS. NR. POS. NO.	MATERIAL-NR. PART NUMBER	BEZEICHNUNG DESCRIPTION
----------------------	-----------------------------	----------------------------	----------------------	-----------------------------	----------------------------

R 22501	△	831120001600	PTC DUO T251-A80-A10
R 22504	△	870004912100	KSW 0411 100 KOHM 5%
R 22506	△	870022905700	KSW NB 0207 220 OHM 5%
R 40502	△	873229600900	DRW 6,5 2,2 OHM 10%
R 50507	△	876642460600	MSW 0207 1,6 OHM 1% ST
R 50508	△	876642460600	MSW 0207 1,6 OHM 1% ST
R 50526	△	870042900500	KSW NB 0207 1,5 OHM 5%
R 50529	△	876635705900	MSW 0414 270 OHM 5%
R 52501	△	870532122300	MOW 0411 8,2 OHM 5%
R 52503	△	873023923900	DRW SI ST7 3W 39 OHM 5%
R 52505	△	870536901900	MOW 0617 5,6 OHM 5% LI
R 52506	△	870536102100	MOW 0617 6,8 OHM 5%
R 53508	△	870042909700	KSW NB 0207 10 KOHM 5% ST
R 53511	△	870522702100	MOW 0411 6,8 OHM 5%
R 53516	△	873028002100	DRW SI S11 7W 6,8 OHM 5%
R 53521	△	870536925700	MOW 0617 220 OHM 10% LI
R 54501	△	873500303300	DRW 0,75W 0,33 OHM 10%
R 55512	△	870536926900	MOW 0617 680 OHM 10% LI
R 55514	△	870123081700	NKS 3 4,7 OHM 5%
R 58501	△	876519810400	MSW 0207 20 KOHM 1%
R 58502	△	876519808600	MSW 0207 3,6 KOHM 1%
R 60502	△	870006935600	KSW 0617 3 MOHM 2%
R 60504	△	870006934100	KSW 0617 680 KOHM 2%
R 60508	△	873018950100	DRW 9 15 KOHM 10%
R 60512	△	870000743200	KSW 0207 20 OHM 5%
R 60528	△	876504414100	MSW 0411 680 KOHM 5%
R 60801	△	876521212700	MSW 0411 180 KOHM 5%
R 60802	△	831140107400	VDR SIOV-S07K385GS3
R 60803	△	870042904500	KSW NB 0207 68 OHM 5%
R 60806	△	876504915300	MSW SI 0414 2,2 MOHM VDE
R 61508	△	879005005400	ESTR.SK10-A 22 KOHM LIN
R 61512	△	870042904900	KSW NB 0207 100 OHM 5% ST
R 61518	△	870522732100	MOW 0411 100 KOHM 10%
R 61527	△	870536930100	MOW 0617 15 KOHM 10% LI
R 61533	△	873506404900	DRW 4 100 OHM 5%
R 62501	△	876504914500	MSW SI 0414 1 MOHM 5% VDE
R 62502	△	831100501700	NTC 4,7 OHM 30%
R 62503	△	831140127500	VDR SIOV-S14K275E2S11M5
R 62549	△	876634915500	MSW SI 0414 2,7 MOHM 5% LI

TR 60801	△	292016299701	SPERRWANDLERTRAFO REVERSE CONVERTER TRANSFORMER
----------	---	--------------	---

SI 52501	△	831561202700	SI LOET T315MA 250V
SI 60501	△	831562000300	SI 5X20 T2A L 250V
SI 61521	△	831562022500	SI LOET T2A 250V
SI 61524	△	831562102700	SI LOET T2,5A 250V
SI 61538	△	831561820000	SI LOET T1A 250V
SI 61561	△	831562022500	SI LOET T2A 250V
SI 61566	△	831562022500	SI LOET T2A 250V
SI 62501	△	831562250300	SI 5X20 T3,15A H 250V

T 21511	△	830340129900	TRANS.BF299 G/PBF259
T 50528	△	830221054400	TRANS BD544B/ BD538
T 50529	△	830221054300	TRANS BD543B/ BD537
T 52503	△	830221068200	TRANS.BD 679A
T 53501	△	830262533100	TRANS 2SC5331
T 60506	△	830263829800	TRANS 2SK2699

TC 22503	△	831001000800	TRIAC BTB08-600CW
----------	---	--------------	-------------------

TR 52501	△	092468679700	UEBERTRAGER TRANSFORMER
----------	---	--------------	----------------------------

TR 53500	△	292016800401	TRAFO DIODEN-SPLIT DIODE SPLIT TRANSFORMER
----------	---	--------------	---

TR 60500	△	292015809700	SPERRWANDLERTRAFO REVERSE CONVERTER TRANSFORMER
----------	---	--------------	---

Es gelten die Vorschriften und Sicherheitshinweise gemäß dem Service Manual "Sicherheit", Mat.-Nummer 720108000000, sowie zusätzlich die eventuell abweichenden, landesspezifischen Vorschriften!



The regulations and safety instructions shall be valid as provided by the "Safety" Service Manual, part number 720108000000, as well as the respective national deviations.

ÄNDERUNGEN VORBEHALTEN / SUBJECT TO ALTERATION

### Ersatzteilliste Spare Parts List

**12 / 2001**

### CHASSIS-FS-STEREO DIGI 100 CUC 1837 CHASSIS TV STEREO DIGI 100 CUC 1837

MATERIAL-NR. / PART NO. : 297040191800

POS. NR. POS. NO.	ABB. FIG.	MATERIAL-NR. PART NUMBER	ANZ. QTY.	BEZEICHNUNG 	DESCRIPTION 
		297040191800		CHASSIS-FS-STEREO DIGI 100 CUC 1837 KEIN E-TEIL	CHASSIS TV STEREO DIGI 100 CUC 1837 NO SPARE PART
0200.000		295042022400	X	BAUSTEIN SIGNAL/ZF+TUNER	MODULE SIGNAL/IF TUNER
0215.000		297033571100		TASTSCHALTER PROGRAMM +	KEY SWITCH PROGRAMME +
0215.000		297033571100		TASTSCHALTER PROGRAMM -	KEY SWITCH PROGRAMME -
0215.000		297033571100		TASTSCHALTER LAUTSTAERKE +	KEY SWITCH VOLUME +
0215.000		297033571100		TASTSCHALTER LAUTSTAERKE -	KEY SWITCH VOLUME -
0216.000		295017660102		TASTENSATZ PROGRAMM/LAUTSTAERKE	KEY SET PROGRAMME/VOLUME
0240.000		293033904200		KOPFHOERERBUCHSE 3,5mm O.SCHALTER	HEADPHONE SOCKET 3,5mm W/O SWITCH
0241.000		293031680503		CINCH-BUCHSE 3-FACH FBAS/NF L,R	CINCH SOCKET 3 FOLD FBAS/AF L,R
0450.000		297006520103		HALTER BAUSTEIN	HOLDER MODULE
0600.000		295042032200	X	BAUSTEIN FEATURE	MODULE FEATURE
1000.000		096211130206	4	SICHERUNGSHALTER Si60501/62501	FUSE HOLDER Si60501/62501
2000.000	△	297033910100		NETZSCHALTER O.WISCHER	POWER SWITCH W/O WIPER
2200.000	△	293033996601		NETZ EINBAUGERAETESTECKER	APPLIANCE PLUG
2400.000		293031530107	2	MONTAGECLIP IC40510	MOUNTING CLIP IC40510
2410.000		293031530208		MONTAGECLIP IC40510	MOUNTING CLIP IC40510
2430.000		293031531208	10	MONTAGECLIP D53571/53572/60506/61516/61521/61524	MOUNTING CLIP D53571/53572/60506/61516/61521/61524
WW.		293031531802	10	MONTAGECLIP D53571/53572/60506/61516/61521/61524	MOUNTING CLIP D53571/53572/60506/61516/61521/61524
2450.000		293031531605		IC50510/T50528/50529/52503	IC50510/T50528/50529/52503
2455.000		293031561600	2	MONTAGECLIP T52503	MOUNTING CLIP T52503
WW.		293031561700	2	ISOLIERUNG D60019/60021	INSULATING D60019/60021
2465.000		293031561800		FOLIE WAERMELEITEND D60506	FOIL HEAT CONDUCTING D60506
2470.000		293031562000	7	FOLIE WAERMELEITEND T50528/50529/52503/IC50510/D61516/61521/61524	FOIL HEAT CONDUCTING T50528/50529/52503/IC50510/D61516/61521/61524
2480.000		293031562100	2	FOLIE WAERMELEITEND D53571/53572	FOIL HEAT CONDUCTING D53571/53572
2485.000		293031562300		FOLIE WAERMELEITEND T53501	FOIL HEAT CONDUCTING T53501
2490.000		293031562800	2	FOLIE WAERMELEITEND D60019/60021	FOIL HEAT CONDUCTING D60019/60021
2495.000		293031563301		FOLIE WAERMELEITEND T60506	FOIL HEAT CONDUCTING T60506
				X = SIEHE GESONDERTE E-LISTE	X = SEE SEPARATE PARTS LIST
				WW. = WAHLWEISE	WW. = OPTIONAL

POS. NR. POS. NO.	MATERIAL-NR. PART NUMBER	BEZEICHNUNG DESCRIPTION
----------------------	-----------------------------	----------------------------

C 40502	845299615000	ELKO 2200UF 20% 25V
C 50512	845299614700	ELKO 1000UF 20% 25V
C 50526	845299614700	ELKO 1000UF 20% 25V
C 53512	851591160200	FOKO FKP1 142PF 2,5% 2000V
C 53571	851591471900	FOKO FKP1 0,012UF 3,5% 2000V
C 60506	865006704600	KERKO HV C 100PF 20% 1KV
C 60509	851591104000	FOKO FKP1 220PF 10% 1600V
C 60512	865008111100	KERKO HV C 270PF 20% 2KV
C 60518	851591140300	FOKO FKP1 0,01UF 5% 1250V
C 60519	865006704600	KERKO HV C 100PF 20% 1KV
C 60521	865006704600	KERKO HV C 100PF 20% 1KV
C 60523	865008112500	KERKO HV C 100PF 20% 1KV
C 60524	865008112500	KERKO HV C 100PF 20% 1KV

POS. NR. POS. NO.	MATERIAL-NR. PART NUMBER	BEZEICHNUNG DESCRIPTION
----------------------	-----------------------------	----------------------------

C 60526	865008112500	KERKO HV C 1000PF 20% 1KV
C 60527	865008112500	KERKO HV C 1000PF 20% 1KV
C 60528	844330315000	ELKO SNT #3 150UF 20% 450V
C 60529	851179301800	FOKO MP3 0,1UF 20% 275V
C 60801	865006703100	KERKO HV C 47PF 20% 2KV
C 60802	865008112500	KERKO HV C 100PF 20% 1KV
C 61511	865006704600	KERKO HV C 100PF 20% 1KV
C 61512	865006704600	KERKO HV C 100PF 20% 1KV
C 61514	851591103800	FOKO FKP1 100PF 10% 1600V
C 61521	865006704600	KERKO HV C 100PF 20% 1KV
C 61522	845209705500	ELKO #16 600/680UF +50-20 63V
C 61524	865006704600	KERKO HV C 100PF 20% 1KV
C 61561	865006704600	KERKO HV C 100PF 20% 1KV

ÄNDERUNGEN VORBEHALTEN / SUBJECT TO ALTERATION

Table with 3 columns: POS. NR., MATERIAL-NR., BEZEICHNUNG. Contains electronic components like ELKO #39, KOKO MP3/KT, MELF DIODE MCL4148, SMD TRANS, and DIODE 1N4004.

Table with 3 columns: POS. NR., MATERIAL-NR., BEZEICHNUNG. Contains electronic components like GLR.SKB380C1500, DIODE 10B 0,5W, IC TDA7297, FERRITPERLE HF70 BTL 3,5X, and SMD DAEMPF-PERLE 0805 BLM.

Table with 3 columns: POS. NR., MATERIAL-NR., BEZEICHNUNG. Contains electronic components like ENTSTOER-DR 2X22MH INTERFERENCE CHOKE, OPTOKOPPLER, KSW 0207 1,5 MOHM 5%, and TRIAC BTB08-600CW F17.

Table with 3 columns: POS. NR., MATERIAL-NR., BEZEICHNUNG. Contains electronic components like UEBERTRAGER TRANSFORMER DRIVER, SPERRWANDLERTRAFO B.O.TYPER CONVERTER, and TRANS BF299G.

ÄNDERUNGEN VORBEHALTEN / SUBJECT TO ALTERATION

Warning notice: 'Es gelten die Vorschriften und Sicherheitshinweise gemäß dem Service Manual "Sicherheit", Mat.-Nummer 720108000000, sowie zusätzlich die eventuell abweichenden, landesspezifischen Vorschriften!' with a warning icon and 'Die regulations and safety instructions shall be valid as provided by the "Safety" Service Manual, part number 720108000000, as well as the respective national deviations.' and 'ÄNDERUNGEN VORBEHALTEN / SUBJECT TO ALTERATION'.



POS. NR.	MATERIAL-NR.	BEZEICHNUNG
POS. NO.	PART NUMBER	DESCRIPTION

R 22501	△ 831120001600	PTC DUO T251-A80-A10
R 22504	△ 870004912100	KSW 0411 100 KOHM 5%
R 22506	△ 870022905700	KSW NB 0207 220 OHM 5%
R 40502	△ 873229600900	DRW 6,5 2,2 OHM 10%
R 50507	△ 876642460500	MSW 0207 1,5 OHM 1%
R 50508	△ 876642460500	MSW 0207 1,5 OHM 1%
R 50526	△ 870042900500	KSW NB 0207 1,5 OHM 5%
R 50529	△ 876635705900	MSW 0414 270 OHM 5%
R 52501	△ 870532122300	MOW 0411 8,2 OHM 5%
R 52503	△ 873023923900	DRW SI ST7 3W 39 OHM 5%
R 52505	△ 870536901700	MOW 0617 4,7 OHM 5% LI
R 52506	△ 870536901700	MOW 0617 4,7 OHM 5% LI
R 53508	△ 870042909700	KSW NB 0207 10 KOHM 5% ST

R 53511	△ 870522702100	MOW 0411 6,8 OHM 5%
R 53516	△ 873028002100	DRW SI S11 7W 6,8 OHM 5%
R 53521	△ 870536906300	MOW 0617 390 OHM 5% LI
R 54501	△ 873500303300	DRW 0,75W 0,33 OHM 10%
R 55512	△ 870536906500	MOW 0617 470 OHM 5% LI
R 55514	△ 870123081700	NKS 3 4,7 OHM 5%
R 58501	△ 876519810400	MSW 0207 20 KOHM 1%
R 58502	△ 876519808600	MSW 0207 3,6 KOHM 1%
R 60502	△ 870006935600	KSW 0617 3 MOHM 2%
R 60504	△ 870006934100	KSW 0617 680 KOHM 2%
R 60508	△ 873018950100	DRW 9 15 KOHM 10%
R 60512	△ 870000743200	KSW 0207 20 OHM 5%
R 60801	△ 876521212700	MSW 0411 180 KOHM 5%
R 60802	△ 831140107400	VDR SIOV-S07K385GS3
R 60803	△ 870042904500	KSW NB 0207 68 OHM 5%
R 60806	△ 876504915300	MSW SI 0414 2,2 MOHM VDE

R 61508	△ 879005005400	ESTR.SK10-A 22 KOHM LIN
R 61512	△ 870042904900	KSW NB 0207 100 OHM 5% ST

R 61518	△ 870522732100	MOW 0411 100 KOHM 10%
R 61527	△ 870536930100	MOW 0617 15 KOHM 10% LI
R 61533	△ 873506404900	DRW 4 100 OHM 5%
R 62501	△ 876504914500	MSW SI 0414 1 MOHM 5% VDE

R 62502	△ 831100501700	NTC 4,7 OHM 30%
R 62503	△ 831140127500	VDR SIOV-S14K275E2S11M5
R 62549	△ 876634915500	MSW SI 0414 2,7 MOHM 5% LI

SI 52501	△ 831561202700	SI LOET T315MA 250V
SI 60501	△ 831562000300	SI 5X20 T2A L 250V
SI 61521	△ 831562022500	SI LOET T2A 250V
SI 61524	△ 831562102700	SI LOET T2,5A 250V
SI 61538	△ 831561820000	SI LOET T1A 250V
SI 61561	△ 831562022500	SI LOET T2A 250V
SI 61566	△ 831562022500	SI LOET T2A 250V
SI 62501	△ 831562250300	SI 5X20 T3,15A H 250V

T 21511	830340129900	TRANS.BF299 G/PBF259
T 50528	830221054400	TRANS BD544B/ BD538
T 50529	830221054300	TRANS BD543B/ BD537
T 52503	830221068200	TRANS.BD 679A
T 53501	830262533100	TRANS 2SK5331
T 60506	830263829800	TRANS 2SK2699

TC 22503	△ 831001000800	TRIAC BTB08-600CW
----------	----------------	-------------------

TR 52501	△ 092468679700	UEBERTRAGER TRANSFORMER
----------	----------------	-------------------------

TR 53500	△ 292016800401	TRAFO DIODEN-SPLIT DIODE SPLIT TRANSFORMER
----------	----------------	--

Es gelten die Vorschriften und Sicherheitshinweise gemäß dem Service Manual "Sicherheit", Mat.-Nummer 720108000000, sowie zusätzlich die eventuell abweichenden, landesspezifischen Vorschriften!



The regulations and safety instructions shall be valid as provided by the "Safety" Service Manual, part number 720108000000, as well as the respective national deviations.

ÄNDERUNGEN VORBEHALTEN / SUBJECT TO ALTERATION

POS. NR.	MATERIAL-NR.	BEZEICHNUNG
POS. NO.	PART NUMBER	DESCRIPTION

TR 60500	△ 292015809700	SPERRWANDLERTRAFO REVERSE CONVERTER TRANSFORMER
TR 60801	△ 292016299701	SPERRWANDLERTRAFO REVERSE CONVERTER TRANSFORMER

## Ersatzteilliste

### Spare Parts List

### 6 / 2002

## CHASSIS-FS-STEREO DIGI 100 CUC 1837

## CHASSIS TV STEREO DIGI 100 CUC 1837

MATERIAL-NR. / PART NO.: 297040192600

POS. NR.	ABB.	MATERIAL-NR.	ANZ.	BEZEICHNUNG	DESCRIPTION
POS. NO.	FIG.	PART NUMBER	QTY.	(D)	(GB)
		297040192600		CHASSIS-FS-STEREO DIGI 100 CUC 1837 KEIN E-TEIL	CHASSIS TV STEREO DIGI 100 CUC 1837 NO SPARE PART
0200.000		295042622400	X	BAUSTEIN SIGNAL/ZF+TUNER	MODULE SIGNAL/IF+TUNER
0400.000		295042032200	X	BAUSTEIN FEATURE	MODULE FEATURE
0450.000		297006521102		HALTER BAUSTEIN	HOLDER MODULE
1000.000		096211130206	4	SICHERUNGSHALTER SI60501/62501	FUSE HOLDER SI60501/62501
2200.000	△	293033994802		NETZ EINBAUGERAETESTECKER	APPLIANCE COUPLER
2400.000		293031530107	2	MONTAGECLIP T53501/60506	MOUNTING CLIP T53501/60506
2410.000		293031530208		MONTAGECLIP IC40510	MOUNTING CLIP IC40510
2430.000		293031531208	8	MONTAGECLIP D53571/53572/61516/61521 D61524/IC50510/T50528/50529	MOUNTING CLIP D53571/53572/61516/61521 D61524/IC50510/T50528/50529
WW.		293031531802	8	MONTAGECLIP D53571/53572/61516/61521 D61524/IC50510/T50528/50529	MOUNTING CLIP D53571/53572/61516/61521 D61524/IC50510/T50528/50529
2445.000		293031531605		MONTAGECLIP T52503	MOUNTING CLIP T52503
2455.000		293031561600	2	ISOLIERUNG D60019/60021	INSULATING D60019/60021
WW.		293031561700	2	ISOLIERUNG D60019/60021	INSULATING D60019/60021
2470.000		293031562000	6	FOLIE WAERMELEITEND D61516/61521/61524/IC50510/T50528/50529	FOIL HEAT CONDUCTING D61516/61521/61524/IC50510/T50528/50529
2480.000		293031562100	2	FOLIE WAERMELEITEND D53571/53572	FOIL HEAT CONDUCTING D53571/53572
2485.000		293031562300		FOLIE WAERMELEITEND T53501	FOIL HEAT CONDUCTING T53501
2490.000		293031562800	2	FOLIE WAERMELEITEND D60019/60021	FOIL HEAT CONDUCTING D60019/60021
2495.000		293031563301		FOLIE WAERMELEITEND T60506	FOIL HEAT CONDUCTING T60506
				X = SIEHE GESONDERTE E-LISTE	X = SEE SEPARATE PARTS LIST
				WW. = WAHLWEISE	WW. = OPTIONAL

POS. NR.	MATERIAL-NR.	BEZEICHNUNG	POS. NR.	MATERIAL-NR.	BEZEICHNUNG
POS. NO.	PART NUMBER	DESCRIPTION	POS. NO.	PART NUMBER	DESCRIPTION
C 40502	845299615000	ELKO 2200UF 20% 25V	C 61524	865006704600	KERKO HV C 100PF 20% 1KV
C 50512	845299614700	ELKO 1000UF 20% 25V	C 61561	865006704600	KERKO HV C 100PF 20% 1KV
C 50526	845299614700	ELKO 1000UF 20% 25V	C 61562	845209701500	ELKO #39 1000UF +50-20% 25V
C 53512	851591160200	FOKO FKP1 142PF 2,5% 2000V	C 61563	845209701500	ELKO #39 1000UF +50-20% 25V
C 53571	851591471900	FOKO FKP1 0,012UF 3,5% 2000V	C 61566	865006704600	KERKO HV C 100PF 20% 1KV
C 60506	865006704600	KERKO HV C 100PF 20% 1KV	C 62501	△ 851179304700	FOKO MP3/KT 0,47UF20% 275V
C 60509	851591104000	FOKO FKP1 220PF 10% 1600V	C 62502	△ 851179304700	FOKO MP3/KT 0,47UF20% 275V
C 60512	865008111100	KERKO HV C 270PF 20% 2KV	C 62521	△ 866009823400	KERKO SI 1200PF 20% 400V
C 60518	851591140300	FOKO FKP1 0,01UF 5% 1250V	C 62548	△ 866009823800	KERKO SI 1000PF 20% 400V
C 60519	865006704600	KERKO HV C 100PF 20% 1KV	C 62549	△ 866009823400	KERKO SI 1000PF 20% 400V
C 60521	865006704600	KERKO HV C 100PF 20% 1KV	CD 21501	833050414800	MELF DIODE MCL4148
C 60523	865008112500	KERKO HV C 1000PF 20% 1KV	CD 21502	833050414800	MELF DIODE MCL4148
C 60524	865008112500	KERKO HV C 1000PF 20% 1KV	CD 21503	833050414800	MELF DIODE MCL4148
C 60526	865008112500	KERKO HV C 1000PF 20% 1KV	CD 21506	832531310300	MELF DIODE BAV103
C 60527	865008112500	KERKO HV C 1000PF 20% 1KV	CD 21666	833050414800	MELF DIODE MCL4148
C 60528	△ 844330315000	ELKO SNT #3 150UF 20% 450V	CD 40536	833050414800	MELF DIODE MCL4148
C 60529	△ 851179301800	FOKO MP3 0,1UF 20% 275V	CD 52503	833050414800	MELF DIODE MCL4148
C 60801	865006703100	KERKO HV C 47PF 20% 2KV	CD 53519	833050414800	MELF DIODE MCL4148
C 60802	865008112500	KERKO HV C 1000PF 20% 1KV	CD 55503	830945504400	MELF Z-DIODE 4,3B 0,5W
C 61512	865006704600	KERKO HV C 100PF 20% 1KV	CD 55504	833050414800	MELF DIODE MCL4148
C 61514	851591103800	FOKO FKP1 100PF 10% 1600V	CD 57501	833050414800	MELF DIODE MCL4148
C 61521	865006704600	KERKO HV C 100PF 20% 1KV	CD 57503	833050414800	MELF DIODE MCL4148
C 61522	845209705500	ELKO #16 600/680UF +50-20% 63V	CD 57504	833050414800	MELF DIODE MCL4148

ÄNDERUNGEN VORBEHALTEN / SUBJECT TO ALTERATION





POS. NR. POS. NO.	MATERIAL-NR. PART NUMBER	BEZEICHNUNG DESCRIPTION
----------------------	-----------------------------	----------------------------

R 60502	870006935600	KSW 0617 3 MOHM 2%
R 60504	870006934100	KSW 0617 680 KOHM 2%
R 60508	873506730100	DRW 7 15 KOHM 10%
R 60512	870000743200	KSW 0207 20 OHM 5%
R 60801	876521212700	MSW 0411 180 KOHM 5%
R 60802	831140107400	VDR SIOV-S07K385GS3
R 60803	870042904500	KSW NB 0207 68 OHM 5%
R 60806	876504915300	MSW SI 0414 2,2 MOHM VDE
R 61508	879005005400	ESTR.SK10-A 22 KOHM LIN
R 61512	870042904900	KSW NB 0207 100 OHM 5% ST
R 61518	870522732100	MOW 0411 100 KOHM 10%
R 61527	870536930100	MOW 0617 15 KOHM 10% LI
R 61533	873506404900	DRW 4 100 OHM 5%
R 62501	876504914500	MSW SI 0414 1 MOHM 5% VDE
R 62502	831100501700	NTC 4,7 OHM 30%
R 62503	831140127500	VDR SIOV-S14K275E2S11M5
R 62549	876634915500	MSW SI 0414 2,7 MOHM 5% LI

SI 52501	831561202700	SI LOET T315MA 250V
SI 60501	831562000300	SI 5X20 T2A L 250V
SI 61521	831562022500	SI LOET T2A 250V
SI 61524	831562102700	SI LOET T2,5A 250V
SI 61538	831561820000	SI LOET T1A 250V
SI 61561	831562022500	SI LOET T2A 250V
SI 61566	831562022500	SI LOET T2A 250V
SI 62501	831562250300	SI 5X20 T3,15A H 250V

T 21511	830340129900	TRANS.BF299 G/PBF259
T 50528	830221054400	TRANS BD544B/ BD538
T 50529	830221054300	TRANS BD543B/ BD537
T 52503	830221068200	TRANS.BD 679A
T 53501	830262533100	TRANS 2SC5331
T 60506	830263829800	TRANS 2SK2699

TC 22503	831001000800	TRIAIC BTB08-600CW
----------	--------------	--------------------

TR 52501	092468679700	UEBERTRAGER TRANSFORMER
TR 53500	292016800200	TRAFO DIODEN-SPLIT DIODE SPLIT TRANSFORMER
TR 60500	292015819700	SPERRWANDLERTRAFO REVERSE CONVERTER TRANSFORMER
TR 60801	292016299701	SPERRWANDLERTRAFO REVERSE CONVERTER TRANSFORMER

POS. NR. POS. NO.	MATERIAL-NR. PART NUMBER	BEZEICHNUNG DESCRIPTION
----------------------	-----------------------------	----------------------------

Ersatzteilliste  
Spare Parts List

6 / 2002

**CHASSIS-FS-STEREO DIGI 100 CUC 1837**  
**CHASSIS TV STEREO DIGI 100 CUC 1837**

MATERIAL-NR. / PART NO.: 297040193400

POS. NR. POS. NO.	ABB. FIG.	MATERIAL-NR. PART NUMBER	ANZ. QTY.	BEZEICHNUNG <b>(D)</b>	DESCRIPTION <b>(GB)</b>
		297040193400		CHASSIS-FS-STEREO DIGI 100 CUC 1837 KEIN E-TEIL	CHASSIS TV STEREO DIGI 100 CUC 1837 NO SPARE PART
0200.000		295042622400	X	BAUSTEIN SIGNAL/ZF+TUNER	MODULE SIGNAL/IF-TUNER
0215.000		297033571100		TASTSCHALTER PROGRAMM +	KEY SWITCH PROGRAMME +
0215.000		297033571100		TASTSCHALTER PROGRAMM -	KEY SWITCH PROGRAMME -
0215.000		297033571100		TASTSCHALTER LAUTSTAERKE +	KEY SWITCH VOLUME +
0215.000		297033571100		TASTSCHALTER LAUTSTAERKE -	KEY SWITCH VOLUME -
0216.000		295017660102		TASTENSATZ PROGRAMM/LAUTSTAERKE	KEY SET PROGRAMME/VOLUME
0240.000		293033904200		KOPFHOERERBUCHSE 3,5mm O.SCHALTER	HEADPHONE SOCKET 3,5mm W/O SWITCH
0241.000		293031680503		CINCH-BUCHSE 3-FACH FBAS/NF L,R	CINCH SOCKET 3 FOLD FBAS/AF L,R
0400.000		295042032100	X	BAUSTEIN FEATURE	MODULE FEATURE
0450.000		297006521102		HALTER BAUSTEIN	HOLDER MODULE
1000.000		096211130206	4	SICHERUNGSHALTER SI60501/62501	FUSE HOLDER SI60501/62501
2000.000		297033910100		NETZSCHALTER O.WISCHER	POWER SWITCH W/O WIPER
2400.000		293031530107	2	MONTAGECLIP T53501/60506	MOUNTING CLIP T53501/60506
2410.000		293031530208		MONTAGECLIP IC40510	MOUNTING CLIP IC40510
2430.000		293031531208	8	MONTAGECLIP D53571/53572/61516/61521 D61524/IC50510/T50528/50529	MOUNTING CLIP D53571/53572/61516/61521 D61524/IC50510/T50528/50529
WW.		293031531802	8	MONTAGECLIP D53571/53572/61516/61521 D61524/IC50510/T50528/50529	MOUNTING CLIP D53571/53572/61516/61521 D61524/IC50510/T50528/50529
2445.000		293031531605		MONTAGECLIP T52503	MOUNTING CLIP T52503
2455.000		293031561600	2	ISOLIERUNG D60019/60021	INSULATING D60019/60021
WW.		293031561700	2	ISOLIERUNG D60019/60021	INSULATING D60019/60021
2470.000		293031562000	6	FOLIE WAERMELEITEND D61516/61521/ 61524/IC50510/T50528/50529	FOIL HEAT CONDUCTING D61516/61521/ 61524/IC50510/T50528/50529
2480.000		293031562100	2	FOLIE WAERMELEITEND D53571/53572	FOIL HEAT CONDUCTING D53571/53572
2485.000		293031562300		FOLIE WAERMELEITEND T53501	FOIL HEAT CONDUCTING T53501
2490.000		293031562800	2	FOLIE WAERMELEITEND D60019/60021	FOIL HEAT CONDUCTING D60019/60021
2495.000		293031563301		FOLIE WAERMELEITEND T60506	FOIL HEAT CONDUCTING T60506
				X = SIEHE GESONDERTE E-LISTE	X = SEE SEPARATE PARTS LIST
				WW. = WAHLWEISE	WW. = OPTIONAL

POS. NR. POS. NO.	MATERIAL-NR. PART NUMBER	BEZEICHNUNG DESCRIPTION
----------------------	-----------------------------	----------------------------

C 40502	845299615000	ELKO 2200UF 20% 25V
C 50512	845299614700	ELKO 1000UF 20% 25V
C 50526	845299614700	ELKO 1000UF 20% 25V
C 53512	851591160200	FOKO FKP1 142PF 2,5% 2000V
C 53571	851591471900	FOKO FKP1 0,012UF 3,5% 2000V
C 60506	865006704600	KERKO HV C 100PF 20% 1KV
C 60509	851591104000	FOKO FKP1 220PF 10% 1600V
C 60512	865008111100	KERKO HV C 270PF 20% 2KV
C 60518	851591140300	FOKO FKP1 0,01UF 5% 1250V
C 60519	865006704600	KERKO HV C 100PF 20% 1KV
C 60521	865006704600	KERKO HV C 100PF 20% 1KV
C 60523	865008112500	KERKO HV C 1000PF 20% 1KV
C 60524	865008112500	KERKO HV C 1000PF 20% 1KV
C 60526	865008112500	KERKO HV C 1000PF 20% 1KV
C 60527	865008112500	KERKO HV C 1000PF 20% 1KV
C 60528	844330315000	ELKO SNT #3 150UF 20% 450V
C 60529	851179301800	FOKO MP3 0,1UF 20% 275V

POS. NR. POS. NO.	MATERIAL-NR. PART NUMBER	BEZEICHNUNG DESCRIPTION
----------------------	-----------------------------	----------------------------

C 60801	865006703100	KERKO HV C 47PF 20% 2KV
C 60802	865008112500	KERKO HV C 1000PF 20% 1KV
C 61511	865006704600	KERKO HV C 100PF 20% 1KV
C 61512	865006704600	KERKO HV C 100PF 20% 1KV
C 61514	851591103900	FOKO FKP1 100PF 10% 1600V
C 61521	865006704600	KERKO HV C 100PF 20% 1KV
C 61522	845209705500	ELKO #16 600/680UF +50-20 63V
C 61524	865006704600	KERKO HV C 100PF 20% 1KV
C 61561	865006704600	KERKO HV C 100PF 20% 1KV
C 61562	845209701500	ELKO #39 1000UF +50-20% 25V
C 61563	845209701500	ELKO #39 1000UF +50-20% 25V
C 61566	865006704600	KERKO HV C 100PF 20% 1KV
C 62501	851179304700	FOKO MP3/KT 0,47UF20% 275V
C 62502	851179304700	FOKO MP3/KT 0,47UF20% 275V
C 62521	866009823400	KERKO SI 1000PF 20% 400V
C 62548	866009823800	KERKO SI 2200PF 20% 400V
C 62549	866009823400	KERKO SI 1000PF 20% 400V

Es gelten die Vorschriften und Sicherheitshinweise gemäß dem Service Manual "Sicherheit", Mat.-Nummer 720108000000, sowie zusätzlich die eventuell abweichenden, landesspezifischen Vorschriften!



The regulations and safety instructions shall be valid as provided by the "Safety" Service Manual, part number 720108000000, as well as the respective national deviations.

ÄNDERUNGEN VORBEHALTEN / SUBJECT TO ALTERATION

ÄNDERUNGEN VORBEHALTEN / SUBJECT TO ALTERATION





POS. NR.	MATERIAL-NR.	BEZEICHNUNG
POS. NO.	PART NUMBER	DESCRIPTION

POS. NR.	MATERIAL-NR.	BEZEICHNUNG
POS. NO.	PART NUMBER	DESCRIPTION

R 53521	△	870536906300	MOW 0617 390 OHM 5%
R 54501	△	873500303300	DRW 0,75W 0,33 OHM 10%
R 55512	△	870536906500	MOW 0617 470 OHM 5%
R 55514	△	870123081700	NKS 3 4,7 OHM 5%
R 58501		876519810400	MSW 0207 20 KOHM 1%
R 58502		876519808600	MSW 0207 3,6 KOHM 1%
R 58524		870001134500	KSW 0204 1 MOHM 5%
R 60502		870006935600	KSW 0617 3 MOHM 2%
R 60504		870006934100	KSW 0617 680 KOHM 2%
R 60508		873506730100	DRW 7 15 KOHM 10%
R 60512		870000743200	KSW 0207 20 OHM 5%
R 60802	△	831140107400	VDR SIOV-S07K385GS3
R 60803	△	870042904500	KSW NB 0207 68 OHM 5%
R 60804		870000740100	KSW 0207 1 OHM 5%
R 60806	△	876504915300	MSW SI 0414 2,2 MOHM
R 61508		879005005400	ESTR.SK10-A 22 KOHM LIN
R 61512	△	870042904900	KSW NB 0207 100 OHM 5%
R 61518		870522732100	MOW 0411 100 KOHM 10%
R 61527	△	870536930100	MOW 0617 15 KOHM 10%
R 61533		873506404900	DRW 4 100 OHM 5%
R 62501	△	876504914500	MSW SI 0414 1 MOHM 5%
R 62502		831100501700	NTC 4,7 OHM 30%
R 62503	△	831140127500	VDR SIOV-S14K275E2S11M5
R 62549	△	876634915500	MSW SI 0414 2,7 MOHM 5%

SI 52501	△	831561202700	SI LOET T315MA 250V
SI 60501	△	831562000300	SI 5X20 T2A L 250V
SI 61521	△	831562022500	SI LOET T2A 250V
SI 61524	△	831562102700	SI LOET T2,5A 250V
SI 61538	△	831561820000	SI LOET T1A 250V
SI 61561	△	831562022500	SI LOET T2A 250V
SI 61566	△	831562022500	SI LOET T2A 250V
SI 62501	△	831562250300	SI 5X20 T3,15A H 250V

T 21511		830340129900	TRANS BF299G
T 50528		830221054400	TRANS BD544B
T 50529		830221054300	TRANS BD543B
T 52503		830221068200	TRANS BD679A
T 53501		830262533100	TRANS 2SC5331
T 60506		830263829800	TRANS 2SK2699

TC 22503	△	831001000800	TRIAC BTB08-600CW F17
----------	---	--------------	-----------------------

TR 52501	△	092468679700	UEBERTRAGER VOGT
----------	---	--------------	------------------

TR 53500	△	292016800401	TRANSFORMER DRIVER TRAFO DIODEN-SPLIT TRANSFORMER DIODE SPLIT
TR 60500	△	292015809700	SPERRWANDLERTRAFO
WW.	△	292016299701	SPERRWANDLERTRAFO B.O.TYPE CONVERTER TRANSFORMER

Es gelten die Vorschriften und Sicherheitshinweise gemäß dem Service Manual "Sicherheit", Mat.-Nummer 720108000000, sowie zusätzlich die eventuell abweichenden, landesspezifischen Vorschriften!



The regulations and safety instructions shall be valid as provided by the "Safety" Service Manual, part number 720108000000, as well as the respective national deviations.

ÄNDERUNGEN VORBEHALTEN / SUBJECT TO ALTERATION

## Ersatzteilliste Spare Parts List

### 6 / 2002

## CHASSIS-FS-STEREO DIGI 100 CUC 1837 CHASSIS TV STEREO DIGI 100 CUC 1837

MATERIAL-NR. / PART NO.: 297040194500

POS. NR.	ABB.	MATERIAL-NR.	ANZ.	BEZEICHNUNG	DESCRIPTION
POS. NO.	FIG.	PART NUMBER	QTY.	(D)	(GB)
		297040194500		CHASSIS-FS-STEREO DIGI 100 CUC 1837 KEIN E-TEIL	CHASSIS TV STEREO DIGI 100 CUC 1837 NO SPARE PART
0200.000		295042022400	X	BAUSTEIN SIGNAL/ZF+TUNER	MODULE SIGNAL/IF+TUNER
0400.000		295042034200	X	BAUSTEIN FEATURE	MODULE FEATURE
0450.000		297006521102		HALTER BAUSTEIN	HOLDER MODULE
1000.000		096211130206	4	SICHERUNGSHALTER SI60501/62501	FUSE HOLDER SI60501/62501
2200.000	△	293033994802		NETZ EINBAUGERAETESTECKER	APPLIANCE COUPLER
2400.000		293031530107	2	MONTAGECLIP T53501/60506	MOUNTING CLIP T53501/60506
2410.000		293031530208		MONTAGECLIP IC40510	MOUNTING CLIP IC40510
2430.000		293031531208	8	MONTAGECLIP D53571/53572/61516/61521 D61524/IC50510/T50528/50529	MOUNTING CLIP D53571/53572/61516/61521 D61524/IC50510/T50528/50529
WW.		293031531802	8	MONTAGECLIP D53571/53572/61516/61521 D61524/IC50510/T50528/50529	MOUNTING CLIP D53571/53572/61516/61521 D61524/IC50510/T50528/50529
2445.000		293031531605		MONTAGECLIP T52503	MOUNTING CLIP T52503
2455.000		293031561600	2	ISOLIERUNG D60019/60021	INSULATING D60019/60021
WW.		293031561700	2	ISOLIERUNG D60019/60021	INSULATION D60019/60021
2470.000		293031562000	6	FOLIE WAERMELEITEND D61516/61521/ 61524/IC50510/T50528/50529	FOIL HEAT CONDUCTING D61516/61521/ 61524/IC50510/T50528/50529
2480.000		293031562100	2	FOLIE WAERMELEITEND D53571/53572	FOIL HEAT CONDUCTING D53571/53572
2485.000		293031562300		FOLIE WAERMELEITEND T53501	FOIL HEAT CONDUCTING T53501
2490.000		293031562800	2	FOLIE WAERMELEITEND D60019/60021	FOIL HEAT CONDUCTING D60019/60021
2495.000		293031563301		FOLIE WAERMELEITEND T60506	FOIL HEAT CONDUCTING T60506
				X = SIEHE GESONDERTE E-LISTE WW. = WAHLWEISE	X = SEE SEPARATE PARTS LIST WW. = OPTIONAL

POS. NR.	MATERIAL-NR.	BEZEICHNUNG	POS. NR.	MATERIAL-NR.	BEZEICHNUNG	
POS. NO.	PART NUMBER	DESCRIPTION	POS. NO.	PART NUMBER	DESCRIPTION	
C 40502	845299615000	ELKO 2200UF 20% 25V	C 61561	865006704600	KERKO HV C 100PF 20% 1KV	
C 50512	845299614700	ELKO 1000UF 20% 25V	C 61562	845209701500	ELKO #39 1000UF +50-20% 25V	
C 50526	845299614700	ELKO 1000UF 20% 25V	C 61563	845209701500	ELKO #39 1000UF +50-20% 25V	
C 53512	851591160200	FOKO FKP1 142PF 2,5% 2000V	C 61566	865006704600	KERKO HV C 100PF 20% 1KV	
C 53571	851591471700	FOKO FKP1 0,01 UF 3,5% 2000V	C 62501	△	851179304700	FOKO MP3/KT 0,47UF20% 275V
C 60506	865006704600	KERKO HV C 100PF 20% 1KV	C 62502	△	851179304700	FOKO MP3/KT 0,47UF20% 275V
C 60509	851591104000	FOKO FKP1 220PF 10% 1600V	C 62521	△	866009823400	KERKO SI 1000PF 20% 400V
C 60512	865008111100	KERKO HV C 270PF 20% 2KV	C 62548	△	866009823800	KERKO SI 2200PF 20% 400V
C 60518	851591140300	FOKO FKP1 0,01UF 5% 1250V	C 62549	△	866009823400	KERKO SI 1000PF 20% 400V
C 60519	865006704600	KERKO HV C 100PF 20% 1KV				
C 60521	865006704600	KERKO HV C 100PF 20% 1KV	CD 21501	833050414800	MELF DIODE MCL4148	
C 60523	865008112500	KERKO HV C 1000PF 20% 1KV	CD 21502	833050414800	MELF DIODE MCL4148	
C 60524	865008112500	KERKO HV C 1000PF 20% 1KV	CD 21503	833050414800	MELF DIODE MCL4148	
C 60526	865008112500	KERKO HV C 1000PF 20% 1KV	CD 21506	832531310300	MELF DIODE BAV103	
C 60527	865008112500	KERKO HV C 1000PF 20% 1KV	CD 21666	833050414800	MELF DIODE MCL4148	
C 60529	△	851179301800	FOKO MP3 0,1UF 20% 275V	CD 40536	833050414800	MELF DIODE MCL4148
C 60801	865006703100	KERKO HV C 47PF 20% 2KV	CD 52503	833050414800	MELF DIODE MCL4148	
C 60802	865008112500	KERKO HV C 1000PF 20% 1KV	CD 53519	833050414800	MELF DIODE MCL4148	
C 61511	865006704600	KERKO HV C 100PF 20% 1KV	CD 55503	830945504000	MELF-Z DIODE 3,9B 0,5W	
C 61512	865006704600	KERKO HV C 100PF 20% 1KV	CD 55504	833050414800	MELF DIODE MCL4148	
C 61514	851591103800	FOKO FKP1 100PF 10% 1600V	CD 57501	833050414800	MELF DIODE MCL4148	
C 61521	865006704600	KERKO HV C 100PF 20% 1KV	CD 57503	833050414800	MELF DIODE MCL4148	
C 61522	845209705500	ELKO #16 600/680UF +50-20% 63V	CD 57504	833050414800	MELF DIODE MCL4148	
C 61524	865006704600	KERKO HV C 100PF 20% 1KV	CD 57506	830945515000	MELF Z-DIODE 15VB 0,5W	

ÄNDERUNGEN VORBEHALTEN / SUBJECT TO ALTERATION



CHASSIS-FS-STEREO CUC 1837 DIGI 100  
CHASSIS TV STEREO CUC 1837 DIGI 100

MATERIAL-NR. / PART NO.: 297040194800

Table with columns: POS. NR., ABB., MATERIAL-NR., ANZ., BEZEICHNUNG, DESCRIPTION. Contains parts for chassis FS-stereo CUC 1837 digi 100 and TV stereo CUC 1837 digi 100.

Table with columns: POS. NR., MATERIAL-NR., BEZEICHNUNG. Contains parts for ELKO 2200UF, ELKO 1000UF, and KERKO HV C.

Table with columns: POS. NR., MATERIAL-NR., BEZEICHNUNG. Contains parts for MELF DIODE MCL4148, SMD TRANS BC848B, DIODE 1N4004, and FERRITPERLE.

POS. NR. MATERIAL-NR. BEZEICHNUNG
POS. NO. PART NUMBER DESCRIPTION

Table with 3 columns: POS. NR., MATERIAL-NR., BEZEICHNUNG. Lists various electronic components and their descriptions.

Table with 3 columns: POS. NR., MATERIAL-NR., BEZEICHNUNG. Lists components like SI LOET and SI 5X20.

Table with 3 columns: POS. NR., MATERIAL-NR., BEZEICHNUNG. Lists TRANS components like TRANS.BF299 and TRANS.BD544B.

Table with 3 columns: POS. NR., MATERIAL-NR., BEZEICHNUNG. Lists TRIAC BTB08-600CW.

Table with 3 columns: POS. NR., MATERIAL-NR., BEZEICHNUNG. Lists UEBERTRAGER, TRAFO DIODEN-SPLIT, SPERRWANDLERTRAFO, and REVERSE CONVERTER TRANSFORMER.

POS. NR. MATERIAL-NR. BEZEICHNUNG
POS. NO. PART NUMBER DESCRIPTION

Table with 3 columns: POS. NR., MATERIAL-NR., BEZEICHNUNG. Lists various electronic components and their descriptions.

Table with 3 columns: POS. NR., MATERIAL-NR., BEZEICHNUNG. Lists components like SI LOET and SI 5X20.

Table with 3 columns: POS. NR., MATERIAL-NR., BEZEICHNUNG. Lists TRANS components like TRANS.BF299 and TRANS.BD544B.

Table with 3 columns: POS. NR., MATERIAL-NR., BEZEICHNUNG. Lists TRIAC BTB08-600CW.

Table with 3 columns: POS. NR., MATERIAL-NR., BEZEICHNUNG. Lists UEBERTRAGER, TRAFO DIODEN-SPLIT, SPERRWANDLERTRAFO, and REVERSE CONVERTER TRANSFORMER.

Ersatzteilliste
Spare Parts List

6 / 2002

CHASSI-FS-STEREO CUC 1837 DIGI 100
CHASSI-FS-STEREO CUC 1837 DIGI 100

MATERIAL-NR. / PART NO.: 297040194900

Main parts list table with 4 columns: POS. NR., ABB. MATERIAL-NR., ANZ., BEZEICHNUNG, and DESCRIPTION. Lists various parts including signal tuners, switches, and clips.

POS. NR. MATERIAL-NR. BEZEICHNUNG
POS. NO. PART NUMBER DESCRIPTION

Table with 3 columns: POS. NR., MATERIAL-NR., BEZEICHNUNG. Lists ELKO, FOKO, and KERKO components.

POS. NR. MATERIAL-NR. BEZEICHNUNG
POS. NO. PART NUMBER DESCRIPTION

Table with 3 columns: POS. NR., MATERIAL-NR., BEZEICHNUNG. Lists KERKO, MELF, and FOKO components.

Es gelten die Vorschriften und Sicherheitshinweise gemäß dem Service Manual "Sicherheit", Mat.-Nummer 720108000000, sowie zusätzlich die eventuell abweichenden, landesspezifischen Vorschriften!



The regulations and safety instructions shall be valid as provided by the "Safety" Service Manual, part number 720108000000, as well as the respective national deviations.

ÄNDERUNGEN VORBEHALTEN / SUBJECT TO ALTERATION

ÄNDERUNGEN VORBEHALTEN / SUBJECT TO ALTERATION

Table with 3 columns: POS. NR., MATERIAL-NR., BEZEICHNUNG. Rows include components like MELF DIODE MCL4148, SMD TRANS BC848B, DIODE 1N4004, etc.

Table with 3 columns: POS. NR., MATERIAL-NR., BEZEICHNUNG. Rows include components like IC LM393P, IC TDA16846, FERRITPERLE HF70 BTL, etc.

Table with 3 columns: POS. NR., MATERIAL-NR., BEZEICHNUNG. Rows include components like KSW NB 0207 220 OHM, MSW 0207 1,3 OHM, DRW SI ST7 3W 39 OHM, etc.

Table with 3 columns: POS. NR., MATERIAL-NR., BEZEICHNUNG. Rows include components like SI LOET T315MA 250V, SI 5X20 T2A L 250V, SI LOET T2A 250V, etc.

187

ÄNDERUNGEN VORBEHALTEN / SUBJECT TO ALTERATION

Es gelten die Vorschriften und Sicherheitshinweise gemäß dem Service Manual "Sicherheit", Mat.-Nummer 720108000000, sowie zusätzlich die eventuell abweichenden, landesspezifischen Vorschriften!
The regulations and safety instructions shall be valid as provided by the "Safety" Service Manual, part number 720108000000, as well as the respective national deviations.
ÄNDERUNGEN VORBEHALTEN / SUBJECT TO ALTERATION



POS. NR. POS. NO.	MATERIAL-NR. PART NUMBER	BEZEICHNUNG DESCRIPTION
----------------------	-----------------------------	----------------------------

R 22506	△ 870022905700	KSW NB 0207 220 OHM 5%
R 40502	△ 873229600900	DRW 6,5 2,2 OHM 10%
R 50507	△ 876642460500	MSW 0207 1,5 OHM 1%
R 50508	△ 876642460500	MSW 0207 1,5 OHM 1%
R 50526	△ 870042900500	KSW NB 0207 1,5 OHM 5%
R 50529	△ 876635705900	MSW 0414 270 OHM 5%
R 52501	△ 870532122100	MOW 0411 6,8 OHM 5%
R 52503	△ 873023923900	DRW SI ST7 3W 39 OHM 5%
R 52505	△ 870536000800	MOW 0617 3,9 OHM 5%
R 52506	△ 870536000800	MOW 0617 3,9 OHM 5%
R 53508	△ 870042909700	KSW NB 0207 10 KOHM 5% ST
R 53511	△ 870522702100	MOW 0411 6,8 OHM 5%
R 53516	△ 873028002100	DRW SI S11 7W 6,8 OHM 5%
R 53521	△ 870536906300	MOW 0617 390 OHM 5% LI
R 54501	△ 873500303300	DRW 0,75W 0,33 OHM 10%
R 55512	△ 870536906500	MOW 0617 470 OHM 5% LI
R 55514	△ 870123081700	NKS 3 4,7 OHM 5%
R 58501	△ 876519810400	MSW 0207 20 KOHM 1%
R 58502	△ 876519808600	MSW 0207 3,6 KOHM 1%
R 60502	△ 870006935600	KSW 0617 3 MOHM 2%
R 60504	△ 870006934100	KSW 0617 680 KOHM 2%
R 60508	△ 873506730100	DRW 7 15 KOHM 10%
R 60512	△ 870000743200	KSW 0207 20 OHM 5%
R 60801	△ 876521212700	MSW 0411 180 KOHM 5%
R 60802	△ 831140107400	VDR SIOV-S07K385GS3
R 60803	△ 870042904500	KSW NB 0207 68 OHM 5%
R 60806	△ 876504915300	MSW SI 0414 2,2 MOHM VDE
R 61508	△ 879005005400	ESTR.SK10-A 22 KOHM LIN
R 61512	△ 870042904900	KSW NB 0207 100 OHM 5% ST
R 61518	△ 870522732100	MOW 0411 100 KOHM 10%
R 61527	△ 870536930100	MOW 0617 15 KOHM 10% LI
R 61533	△ 873506404900	DRW 4 100 OHM 5%
R 62501	△ 876504914500	MSW SI 0414 1 MOHM 5% VDE
R 62502	△ 831100501700	NTC 4,7 OHM 30%
R 62503	△ 831140127500	VDR SIOV-S14K275E2S11M5
R 62549	△ 876634915500	MSW SI 0414 2,7 MOHM 5% LI
SI 52501	△ 831561202700	SI LOET T315MA 250V
SI 60501	△ 831562000300	SI 5X20 T2A L 250V
SI 61521	△ 831562022500	SI LOET T2A 250V
SI 61524	△ 831562102700	SI LOET T2,5A 250V
SI 61538	△ 831561820000	SI LOET T1A 250V
SI 61561	△ 831562022500	SI LOET T2A 250V
SI 61566	△ 831562022500	SI LOET T2A 250V
SI 62501	△ 831562250300	SI 5X20 T3,15A H 250V
T 21511	830340129900	TRANS.BF299 G/PBF259
T 50528	830221054400	TRANS BD544B/ BD538
T 50529	830221054300	TRANS BD543B/ BD537
T 52503	830221068200	TRANS.BD 679A
T 53501	830262533100	TRANS 2SC5331
T 60506	830263829800	TRANS 2SK2699
TC 22503	△ 831001000800	TRIAC BTB08-600CW
TR 52501	△ 092468679700	UEBERTRAGER TRANSFORMER
TR 53500	△ 292016800300	TRAFO DIODEN-SPLIT DIODE SPLIT TRANSFORMER
TR 60500	△ 292015819700	SPERRWANDLERTRAFO REVERSE CONVERTER TRANSFORMER
TR 60801	△ 292016299701	SPERRWANDLERTRAFO REVERSE CONVERTER TRANSFORMER

POS. NR. POS. NO.	MATERIAL-NR. PART NUMBER	BEZEICHNUNG DESCRIPTION
----------------------	-----------------------------	----------------------------

### Ersatzteilliste Spare Parts List

7 / 2002

### CHASSIS-FS-STEREO DIGI 100 CUC 1838 CHASSIS TV STEREO DIGI 100 CUC 1838

ERSETZT AUSGABE 11/2000 SUBSTITUTE EDITION 11/2000 MATERIAL-NR. / PART NO.: 297040112200

POS. NR. POS. NO.	ABB. FIG.	MATERIAL-NR. PART NUMBER	ANZ. QTY.	BEZEICHNUNG Ⓓ	DESCRIPTION Ⓓ
		297040112200		CHASSIS-FS-STEREO DIGI 100 CUC 1838 KEIN E-TEIL	CHASSIS TV STEREO DIGI 100 CUC 1838 NO SPARE PART
0100.000		295042022200	X	BAUSTEIN SIGNAL/ZF+TUNER	MODULE SIGNAL/IF+TUNER
0400.000		295042034300	X	BAUSTEIN FEATURE	MODULE FEATURE
0450.000		297006520102		HALTER BAUSTEIN	HOLDER MODULE
0900.000		295042062100	X	BAUSTEIN PIP/VGA	MODULE PIP/VGA
1000.000	△	096211130206	4	SICHERUNGSHALTER SI60501/62501	FUSE HOLDER SI60501/62501
		293050254300		DYNAMISCHE FOKUSSIERUNGSPLETTE KEIN E-TEIL	DYNAMIC FOCUSING BOARD NO SPARE PART
2200.000	△	293033996601		NETZ EINBAUGERAETESTECKER	APPLIANCE PLUG
2400.000		293031530107	2	MONTAGECLIP T53501/60506	MOUNTING CLIP T53501/60506
2410.000		293031530208		MONTAGECLIP IC40510	MOUNTING CLIP IC40510
2430.000		293031531208	9	MONTAGECLIP D53571/53572/60506 D61516/61521/61524 IC50510/T50528/50529	MOUNTING CLIP D53571/53572/60506 D61516/61521/61524 IC50510/T50528/50529
2450.000		293031531605		MONTAGECLIP T52503	MOUNTING CLIP T52503
2455.000		293031561600		ISOLIERUNG D60019	ISOLATION D60019
2460.000		293031561700		ISOLIERUNG D60021	ISOLATION D60021
2465.000		293031561800		FOILIE WAERMELEITEND D60506	FOIL HEAT CONDUCTING D60506
2470.000		293031562000	6	FOILIE WAERMELEITEND D61516/61521/61524/IC50510/T50528/50529	FOIL HEAT CONDUCTING D61516/61521/61524/IC50510/T50528/50529
2480.000		293031562100		FOILIE WAERMELEITEND D53572	FOIL HEAT CONDUCTING D53572
2485.000		293031562300		FOILIE WAERMELEITEND D53571	FOIL HEAT CONDUCTING D53571
2490.000		293031562800	2	FOILIE WAERMELEITEND D60019/60021	FOIL HEAT CONDUCTING D60019/60021
				X = SIEHE GESONDERTE E-LISTE WW. = WAHLWEISE	X = SEE SEPARATE PARTS LIST WW. = OPTIONAL

POS. NR. POS. NO.	MATERIAL-NR. PART NUMBER	BEZEICHNUNG DESCRIPTION
----------------------	-----------------------------	----------------------------

POS. NR. POS. NO.	MATERIAL-NR. PART NUMBER	BEZEICHNUNG DESCRIPTION
----------------------	-----------------------------	----------------------------

C 40502	845299615000	ELKO 2200UF 20% 25V
C 50512	845299614700	ELKO 1000UF 20% 25V
C 50526	845299614700	ELKO 1000UF 20% 25V
C 53512	851591160200	FOKO FKP1 142PF 2,5% 2000V
C 53571	851591471900	FOKO FKP1 0,012UF 3,5% 2000V
C 60506	865006704600	KERKO HV C 100PF 20% 1KV
C 60509	851591104000	FOKO FKP1 220PF 10% 1600V
C 60512	865008111100	KERKO HV C 270PF 20% 2KV
C 60518	851591140300	FOKO FKP1 0,01UF 5% 1250V
C 60519	865006704600	KERKO HV C 100PF 20% 1KV
C 60521	865006704600	KERKO HV C 100PF 20% 1KV
C 60523	865008112500	KERKO HV C 1000PF 20% 1KV
C 60524	865008112500	KERKO HV C 1000PF 20% 1KV
C 60526	865008112500	KERKO HV C 1000PF 20% 1KV
C 60527	865008112500	KERKO HV C 1000PF 20% 1KV
C 60528	△ 844330315000	ELKO SNT #3 150UF 20% 450V
C 60529	△ 851179301800	MP3 0,1UF 20% 250V

C 60801	865006703100	KERKO HV C 47PF 20% 2KV
C 60802	865008112500	KERKO HV C 1000PF 20% 1KV
C 61511	865006704600	KERKO HV C 100PF 20% 1KV
C 61512	865006704600	KERKO HV C 100PF 20% 1KV
C 61514	851591103800	FOKO FKP1 100PF 10% 1600V
C 61521	865006704600	KERKO HV C 100PF 20% 1KV
C 61522	845209705500	ELKO #16 600/680UF 63V
C 61524	865006704600	KERKO HV C 100PF 20% 1KV
C 61561	865006704600	KERKO HV C 100PF 20% 1KV
C 61562	845209701500	ELKO #39 1000UF 25V
C 61563	845209701500	ELKO #39 1000UF 25V
C 61566	865006704600	KERKO HV C 100PF 20% 1KV
C 62501	△ 851179304700	FOKO MP3 0,47UF20%250V
C 62502	△ 851179304700	FOKO MP3 0,47UF20%250V
C 62521	△ 866009823400	KERKO SI 1000PF 20% 400V
C 62548	△ 866009823800	KERKO SI 2200PF 20% 400V
C 62549	△ 866009823400	KERKO SI 1000PF 20% 400V

Es gelten die Vorschriften und Sicherheitshinweise gemäß dem Service Manual "Sicherheit", Mat.-Nummer 720108000000, sowie zusätzlich die eventuell abweichenden, landesspezifischen Vorschriften!



The regulations and safety instructions shall be valid as provided by the "Safety" Service Manual, part number 720108000000, as well as the respective national deviations.

ÄNDERUNGEN VORBEHALTEN / SUBJECT TO ALTERATION

ÄNDERUNGEN VORBEHALTEN / SUBJECT TO ALTERATION

POS. NR. POS. NO.	MATERIAL-NR. PART NUMBER	BEZEICHNUNG DESCRIPTION	POS. NR. POS. NO.	MATERIAL-NR. PART NUMBER	BEZEICHNUNG DESCRIPTION	POS. NR. POS. NO.	MATERIAL-NR. PART NUMBER	BEZEICHNUNG DESCRIPTION	POS. NR. POS. NO.	MATERIAL-NR. PART NUMBER	BEZEICHNUNG DESCRIPTION																																																									
C 64001 C 64002 C 64006	△ 850220006600 △ 850220006600 851591160900	FOKO WIMADUR 1500PF 6000V FOKO WIMADUR 1500PF 6000V FOKO FKP1 180PF 2000V	D 61503 D 61511 D 61512 D 61516 D 61521 D 61524 D 61533 D 61561 D 61563 D 61566 D 61568 D 64010 D 64011 D 64012 D 64013 D 64014	830972009900 830951603800 830951603800 830951679800 830919682000 830919682000 830920100500 △ 830951717200 830921502000 △ 830951717200 830921502000 830966306800 830920002100 830920002100 830920002100 830920002100	Z DIODE 10B 0,5W DIODE BYV38 DIODE BYV38 DIODE BYT 08 P-1000 DIODE STPR820D DIODE STPR820D DIODE BA157 DIODE BYW172D DIODE 1N4004 DIODE BYW172D DIODE 1N4004 Z-DIODE BZT03D68 DIODE BAV21 DIODE BAV21 DIODE BAV21 DIODE BAV21	FS 64001	293032300200	FUNKENSTRECKE 1,6KV	IC 40510 IC 50510 IC 55510 IC 58510 IC 60510 IC 60801 IC 60817 IC 61510 IC 61535 IC 61545 IC 61555	830536729700 830512597900 830533814500 830520439300 830533464600 830547025300 830546543100 830520435700 830520497800 830520497800 830520497800	IC TDA7297 IC STV9379A IC TDA8145 IC LM393P IC TDA16846 IC TNY253 IC TS431IZ-AP IC LM358N IC L4978 IC L4978 IC L4978	L 53501 L 53502 L 53503	810498205600 810498205600 810498205600	FERRITPERLE HF70 BTL 3,5X FERRITPERLE HF70 BTL 3,5X FERRITPERLE HF70 BTL 3,5X	L 53511 L 53512 L 53521	814050524900 092401144040 292031229700	DR A AX-GA 10UH 10% DROSSEL 1,5 MH/CHOKE LINEARITAETSPREGLER	L 53574	092468596300	SMD TRANS BC848B/BC847B BRIDGE COIL W.CORE	L 55514	092458160100	O/W AUSKOPPELSPULE E/W COUPLING COIL	L 60506 L 60518	297017390800 810498201400	DAEMPF-PERLE UV 930 30 DAEMPF-PERLE 433003038102	L 60528 L 60812	△ 292017119700 814052499200	SPEICHERDROSSEL MEMORY CHOKE SIEB-DROSSEL 10UH 15% 7608 FILTER CHOKE	L 61511 L 61514 L 61521 L 61524	810498201400 810498201400 810498201400 810498201400	DAEMPF-PERLE 433003038102 DAEMPF-PERLE 433003038102 DAEMPF-PERLE 433003038102 DAMPING BEAD	L 61527 L 61538	814052499200 814052499500	SIEB-DROSSEL 10UH SIEB-DROSSEL 330UH FILTER CHOKE	L 61548 L 61548	814052105900 814052106800	SPEICHER-DROSSEL 59UH SPEICHER-DROSSEL 67UH MEMORY CHOKE	L 61549	814052499200	SIEB-DR 10UH FILTER CHOKE	L 61558 L 61558 L 61558 L 61558	814052106800 814052106700 814052105900 814052105900	SPEICHER-DROSSEL 67UH SPEICHER-DROSSEL 67UH SPEICHER-DROSSEL 59UH MEMORY CHOKE	L 61561 L 61562	810498201400 814050506500	DAEMPF-PERLE 433003038102 DAMPING BEAD DR A AX-GA 47UH 5%	L 61566 L 61567 L 62501 L 62527	810498201400 814050506500 △ 295008359700 814053006600	DAEMPF-PERLE 433003038102 DAMPING BEAD DR A AX-GA 47UH 5% ENTSTOER-DROSSEL 2X22MH INTERFERENCE CHOKE BREITBAND-DROSSELSPULE WIDE BAND CHOKE COIL	OK 22505 OK 60531 OK 60546 OK 60805	△ 830600024200 △ 830600001200 △ 830600001200 △ 830600061500	OPTOKOPPLER IL4216-X001 OPTOKOPPLER CNY17F1 OPTOKOPPLER CNY17F1 OPTOKOPPLER SFH615A-2 OPTO COUPLER	R 21512 R 21523 R 22501 R 40502 R 50507 R 50508 R 50526 R 50529 R 52501 R 52503 R 52505 R 52506 R 53508 R 53516 R 53521 R 54501 R 54511 R 55512 R 55514 R 58501 R 58502 R 58524 R 60502 R 60508 R 60512 R 60802 R 60803 R 61508 R 61512 R 61527 R 61533 R 61572 R 62501 R 62502 R 62503 R 62549 R 64006	870000754900 △ 870532901700 △ 831120001800 △ 873229600900 △ 876642460500 △ 876642460500 △ 870042900500 △ 870536905500 △ 870532901700 △ 870536901300 △ 870536901600 △ 870042909700 △ 873028002100 △ 870536906300 △ 873500303300 △ 873500303300 △ 870536906500 △ 870123081700 876519810400 876519808600 870001134500 870006935600 873506730100 870004903200 △ 831140107400 △ 870042904500 879005005400 △ 870042904500 △ 870536930100 873506404900 879005004000 △ 876504914500 831100501700 △ 831140127500 △ 876634915500 △ 293035521200	KSW 0207 1,5 OHM 5% OPTOKOPPLER CNY17F1 PTC DUO B59709-T60-A110 DRW 6,5 2,2 OHM 10% MSW 0207 1,5 OHM 1% MSW 0207 1,5 OHM 1% KSW NB 0207 1,5 OHM 5% MOW 0617 180 OHM 5% MOW 0411 4,7 OHM 5% DRW SI ST7 3W 39 OHM 5% MOW 0617 4,3 OHM 5% MOW 0617 4,3 OHM 5% KSW NB 0207 10 KOHM 5% DRW SI S11 7W 6,8 OHM 5% MOW 0617 390 OHM 5% DRW 0,75W 0,33 OHM 10% DRW 0,75W 0,33 OHM 10% MOW 0617 470 OHM 5% NKS 3 4 7 OHM 5% MSW 0207 20 KOHM 1% MSW 0207 3,6 KOHM 1% KSW 0204 1 MOHM 5% KSW 0617 3 MOHM 2% DRW 7 15 KOHM 10% KSW 0411 20 OHM 5% VDR SIOV-S07K385GS3 KSW NB 0207 68 OHM 5% ESTR.SK10-A 22 KOHM KSW NB 0207 100 OHM 5% MOW 0617 15 KOHM 10% DRW 4 100 OHM 5% ESTR.SK10-A 2,2 KOHM LIN MSW SI 0414 1 MOHM 5% VDE NTC 4,7 OHM 30% VDR SIOV-S14K275E2 MSW SI 0414 2,7 MOHM 5% FOKUS-FUSSPUNKTREGLER	SI 52501 SI 60501 SI 61521 SI 61524 SI 61524 SI 61538 SI 61561 SI 61566 SI 62501	△ 831561202700 △ 831562000300 △ 831562022500 △ 831562102700 △ 831561820000 △ 831562022500 △ 831562022500 △ 831562022500 △ 831562250300	SI LOET T315MA 250V SI 5X20 T2A L 250V SI LOET T2A 250V SI LOET T2,5A 250V SI LOET T1A 250V SI LOET T2A 250V SI LOET T2A 250V SI LOET T2A 250V SI 5X20 T3,15A H 250V	T 21511 T 50528 T 50529 T 52503 T 53501	830340129900 830221054400 830221054300 830221068200 830262533100	TRANS BF299G TRANS BD544B TRANS BD543B TRANS BD679A TRANS 2SC5331	T 60506 T 61505 T 64016 T 64110	830263829900 830225425400 830328763900 830320554800	TRANS 2SK2699 TRANS FETBSN254A TRANS BC639 TRANS BC548B/BC547B	TC 22503 TR 52501 TR 53500 TR 60500 TR 60800 TR 64001	△ 831001000800 092468679700 △ 292016800701 △ 292015849700 △ 292016249700 △ 292014499700	TRIAC BTB08-600CW UEBERTRAGER TRANSFORMER DRIVER DIODEN-SPLIT TRAF0 TRANSFORMER DIODE SPLIT SPERRWANDLERTRAF0 B.O.TYPE CONVERTER TRANSFORMER SPERRWANDLERTRAF0 STANDBY B.O.TYPE CONVERTER TRANSFORMER STANDBY FOKUSSIONSUEBERTRAGER FOCUSING TRANSFORMER

ÄNDERUNGEN VORBEHALTEN / SUBJECT TO ALTERATION

Es gelten die Vorschriften und Sicherheitshinweise gemäß dem Service Manual "Sicherheit", Mat.-Nummer 720108000000, sowie zusätzlich die eventuell abweichenden, landesspezifischen Vorschriften!



The regulations and safety instructions shall be valid as provided by the "Safety" Service Manual, part number 720108000000, as well as the respective national deviations.

ÄNDERUNGEN VORBEHALTEN / SUBJECT TO ALTERATION



Ersatzteilliste  
Spare Parts List

**6 / 2002**

**CHASSIS-FS-STEREO DIGI 100 CUC 1838**  
**CHASSIS TV STEREO DIGI 100 CUC 1838**

MATERIAL-NR. / PART NO.: 297040115300

POS. NR. POS. NO.	MATERIAL-NR. PART NUMBER	BEZEICHNUNG DESCRIPTION
----------------------	-----------------------------	----------------------------

R 54501 $\triangle$	873500303300	DRW 0,75W 0,33 OHM 10%
R 55512 $\triangle$	870536906500	MOW 0617 470 OHM 5% LI
R 55514 $\triangle$	870123081700	NKS 3 4,7 OHM 5%
R 58501	876519810400	MSW 0207 20 KOHM 1%
R 60502	870006935600	KSW 0617 3 MOHM 2%
R 60504	870006934100	KSW 0617 680 KOHM 2%
R 60508	873506730100	DRW 7 15 KOHM 10%
R 60512	870004903200	KSW 0411 20 OHM 5%
R 60528	876504414100	MSW 0411 680 KOHM 5%
R 60801	876521212700	MSW 0411 180 KOHM 5%
R 60802 $\triangle$	831140107400	VDR SIOV-S07K385GS3
R 60803 $\triangle$	870042904500	KSW NB 0207 68 OHM 5%
R 60804 $\triangle$	870042900100	KSW NB 0207 1 OHM 5%
R 61508	879005005400	ESTR.SK10-A 22 KOHM LIN
R 61512 $\triangle$	870042904900	KSW NB 0207 100 OHM 5% ST

R 61518	870522732100	MOW 0411 100 KOHM 10%
R 61527 $\triangle$	870536930100	MOW 0617 15 KOHM 10% LI
R 61533	873506404900	DRW 4 100 OHM 5%
R 62501 $\triangle$	8765049114500	MSW SI 0414 1 MOHM 5% VDE

R 62502	831100501700	NTC 4,7 OHM 30%
R 62503 $\triangle$	831140127500	VDR SIOV-S14K275E2S11M5
R 62549 $\triangle$	8766349115500	MSW SI 0414 2,7 MOHM 5% LI

SI 52501 $\triangle$	831561202700	SI LOET T315MA 250V
SI 60501 $\triangle$	831562000300	SI 5X20 T2A L 250V
SI 61521 $\triangle$	831562022500	SI LOET T2A 250V
SI 61524 $\triangle$	831562102700	SI LOET T2,5A 250V
SI 61538 $\triangle$	831561820000	SI LOET T1A 250V
SI 61561 $\triangle$	831562022500	SI LOET T2A 250V
SI 61566 $\triangle$	831562022500	SI LOET T2A 250V
SI 62501 $\triangle$	831562250300	SI 5X20 T3,15A H 250V

T 50528	830221054400	TRANS BD544B/ BD538
T 50529	830221054300	TRANS BD543B/ BD537
T 52503	830221068200	TRANS.BD 679A
T 53501	830262533100	TRANS 2SC5331
T 60506	830263829900	TRANS 2SK2699

TC 22503 $\triangle$	831001000800	TRIAC BTB08-600CW
----------------------	--------------	-------------------

TR 52501 $\triangle$	092468679700	UEBERTRAGER
TR 53500 $\triangle$	292016800300	TRANSFORMER
TR 60500 $\triangle$	292015859701	TRAFO DIODEN-SPLIT DIODE SPLIT TRANSFORMER
TR 60800 $\triangle$	292016249700	SPERRWANDLERTRAFO REVERSE CONVERTER
TR 60800 $\triangle$	292016249700	SPERRWANDLERTRAFO E16/S REVERSE CONVERTER TRANSFORMER

POS. NR. POS. NO.	MATERIAL-NR. PART NUMBER	BEZEICHNUNG DESCRIPTION
----------------------	-----------------------------	----------------------------

POS. NR. POS. NO.	ABB. FIG.	MATERIAL-NR. PART NUMBER	ANZ. QTY.	BEZEICHNUNG $\text{D}$	DESCRIPTION $\text{GB}$
		297040115300		CHASSIS-FS-STEREO DIGI 100 CUC 1838 KEIN E-TEIL	CHASSIS TV STEREO DIGI 100 CUC 1838 NO SPARE PART
0200.000		295042622100	X	BAUSTEIN SIGNAL/ZF+TUNER	MODULE SIGNAL/IF+TUNER
0400.000		295042032200	X	BAUSTEIN FEATURE	MODULE FEATURE
0450.000		297006521102		HALTER BAUSTEIN	HOLDER MODULE
1000.000		096211130206	4	SICHERUNGSHALTER SI60501/62501	FUSE HOLDER SI60501/62501
2200.000	$\triangle$	293033994802		NETZ EINBAUGERAETESTECKER	APPLIANCE COUPLER
2400.000		293031530107	2	MONTAGECLIP T53501/60506	MOUNTING CLIP T53501/60506
2410.000		293031530208		MONTAGECLIP IC40510	MOUNTING CLIP IC 40510
2430.000		293031531208	8	MONTAGECLIP D53571/53572/61516/ 61521/61524/IC50510/T50528/50529	MOUNTING CLIP D53571/53572/61516/ 61521/61524/IC50510/T50528/50529
	WW.	293031531802	8	MONTAGECLIP D53571/53572/61516/ 61521/61524/IC 50510/T50528/50529	MOUNTING CLIP D53571/53572/61516/ 61521/61524/IC 50510/T50528/50529
2450.000		293031531605		MONTAGECLIP T52503	MOUNTING CLIP T52503
2455.000		293031561600	2	ISOLIERUNG D60019/60021	INSULATING D60019/60021
WW.		293031561700	2	ISOLIERUNG D60019/60021	INSULATION D60019/60021
2470.000		293031562000	6	FOLIE WAERMELEITEND D61516/ 61521/61524/IC50510/T50528/50529	FOIL HEAT CONDUCTING D61516/ 61521/61524/IC50510/T50528/50529
2480.000		293031562100	2	FOLIE WAERMELEITEND D53571/53572	FOIL HEAT CONDUCTING D53571/53572
2485.000		293031562300		FOLIE WAERMELEITEND T53501	FOIL HEAT CONDUCTING T53501
2490.000		293031562800	2	FOLIE WAERMELEITEND D60019/60021	FOIL HEAT CONDUCTING D60019/60021
2495.000		293031563301		FOLIE WAERMELEITEND T60506	FOIL HEAT CONDUCTING T60506
X = SIEHE GESONDERTE E-LISTE					X = SEE SEPARATE PARTS LIST
WW. = WAHLWEISE					WW. = OPTIONAL

POS. NR. POS. NO.	MATERIAL-NR. PART NUMBER	BEZEICHNUNG DESCRIPTION
----------------------	-----------------------------	----------------------------

C 40502	845299615000	ELKO 2200UF 20% 25V
C 50512	845299615000	ELKO 2200UF 20% 25V
C 50526	845299865000	ELKO 2200UF 20% 25V
C 53512	851591160200	FOKO FKP1 142PF 2,5% 2000V
C 53571	851591471900	FOKO FKP1 0,012UF 3,5% 2000V
C 60506	865006704600	KERKO HV C 100PF 20% 1KV
C 60509	851591104000	FOKO FKP1 220PF 10% 1600V
C 60512	865008111100	KERKO HV C 270PF 20% 2KV
C 60518	851591140300	FOKO FKP1 0,011UF 5% 1250V
C 60519	865006704600	KERKO HV C 100PF 20% 1KV
C 60521	865006704600	KERKO HV C 100PF 20% 1KV
C 60523	865008112500	KERKO HV C 1000PF 20% 1KV
C 60524	865008112500	KERKO HV C 1000PF 20% 1KV
C 60526	865008112500	KERKO HV C 1000PF 20% 1KV
C 60527	865008112500	KERKO HV C 1000PF 20% 1KV
C 60528 $\triangle$	844330315000	ELKO SNT #3 150UF 20% 450V
C 60529 $\triangle$	851179301800	FOKO MP3 0,1UF 20% 275V
C 60801	865006703100	KERKO HV C 47PF 20% 2KV
C 60802	865008112500	KERKO HV C 1000PF 20% 1KV
C 61511	865006704600	KERKO HV C 100PF 20% 1KV
C 61512	865006704600	KERKO HV C 100PF 20% 1KV
C 61514	851591103800	FOKO FKP1 100PF 10% 1600V
C 61521	865006704600	KERKO HV C 100PF 20% 1KV

POS. NR. POS. NO.	MATERIAL-NR. PART NUMBER	BEZEICHNUNG DESCRIPTION
----------------------	-----------------------------	----------------------------

C 61522	845209705500	ELKO #16 600/680UF +50-20% 63V
C 61524	865006704600	KERKO HV C 100PF 20% 1KV
C 61561	865006704600	KERKO HV C 100PF 20% 1KV
C 61562	845209701500	ELKO #39 1000UF +50-20% 25V
C 61563	845209701500	ELKO #39 1000UF +50-20% 25V
C 61566	865006704600	KERKO HV C 100PF 20% 1KV
C 62501 $\triangle$	851179304700	FOKO MP3/KT 0,47UF20% 275V
C 62502 $\triangle$	851179304700	FOKO MP3/KT 0,47UF20% 275V
C 62521 $\triangle$	86609823400	KERKO SI 1000PF 20% 400V
C 62548 $\triangle$	86609823800	KERKO SI 2200PF 20% 400V
C 62549 $\triangle$	86609823400	KERKO SI 1000PF 20% 400V
CD 21636	833050414800	MELF DIODE MCL4148
CD 21666	833050414800	MELF DIODE MCL4148
CD 40536	833050414800	MELF DIODE MCL4148
CD 52503	833050414800	MELF DIODE MCL4148
CD 53519	833050414800	MELF DIODE MCL4148
CD 55503	830945504400	MELF Z-DIODE 4,3B 0,5W
CD 55504	833050414800	MELF DIODE MCL4148
CD 57501	833050414800	MELF DIODE MCL4148
CD 57503	833050414800	MELF DIODE MCL4148
CD 57504	833050414800	MELF DIODE MCL4148
CD 57506	830945515000	MELF Z-DIODE 15V B 0,5W

Es gelten die Vorschriften und Sicherheitshinweise gemäß dem Service Manual "Sicherheit", Mat.-Nummer 720108000000, sowie zusätzlich die eventuell abweichenden, landesspezifischen Vorschriften!



The regulations and safety instructions shall be valid as provided by the "Safety" Service Manual, part number 720108000000, as well as the respective national deviations.

ÄNDERUNGEN VORBEHALTEN / SUBJECT TO ALTERATION

ÄNDERUNGEN VORBEHALTEN / SUBJECT TO ALTERATION







# Ersatzteilliste Spare Parts List

**7 / 2002**

## CHASSIS-FS-STEREO CUC 1838 DIGI 100 CHASSIS TV STEREO CUC 1838 DIGI 100

MATERIAL-NR. / PART NO.: 297040116700

POS. NR. POS. NO.	MATERIAL-NR. PART NUMBER	BEZEICHNUNG DESCRIPTION
----------------------	-----------------------------	----------------------------

OK 60531	830600001200	OPTOKOPPLER CNY17F1
OK 60546	830600001200	OPTOKOPPLER CNY17F1
OK 60805	830600061500	OPTOKOPPLER SFH615A-2

R 21523	870532901700	MOW 0411 4,7 OHM 5%
R 22501	831120001800	PTC DUO B59709-T60-A110
R 22504	870004912100	KSW 0411 100 KOHM 5%
R 22506	870022905700	KSW NB 0207 220 OHM 5%
R 40502	873229600900	DRW 6,5 2,2 OHM 10%
R 50507	876642460500	MSW 0207 1,5 OHM 1%
R 50508	876642460500	MSW 0207 1,5 OHM 1%
R 50526	870042900500	KSW NB 0207 1,5 OHM 5%
R 50531	870536905500	MOW 0617 180 OHM 5% LI
R 52501	870532901700	MOW 0411 4,7 OHM 5%
R 52503	873023923900	DRW SI ST7 3W 39 OHM 5%
R 52505	870536901600	MOW 0617 4,3 OHM 5% LI
R 52506	870536901600	MOW 0617 4,3 OHM 5% LI
R 53508	870042909700	KSW NB 0207 10 KOHM 5% ST
R 53511	870522702100	MOW 0411 6,8 OHM 5%
R 53516	873028002100	DRW SI S11 7W 6,8 OHM 5%
R 53521	870536906300	MOW 0617 390 OHM 5% LI
R 54501	873500303300	DRW 0,75W 0,33 OHM 10%
R 54511	873500303300	DRW 0,75W 0,33 OHM 10%
R 55512	870536906500	MOW 0617 470 OHM 5% LI
R 55514	870123081700	NKS 3 4,7 OHM 5%
R 58501	876519810400	MSW 0207 20 KOHM 1%
R 58502	876519808600	MSW 0207 3,6 KOHM 1%
R 60502	870006935600	KSW 0617 3 MOHM 2%
R 60504	870006934100	KSW 0617 680 KOHM 2%
R 60508	873506730100	DRW 7 15 KOHM 10%
R 60512	870000743200	KSW 0207 20 OHM 5%
R 60801	876521212700	MSW 0411 180 KOHM 5%
R 60802	831140107400	VDR SIOV-S07K385GS3
R 60803	870042904500	KSW NB 0207 68 OHM 5%
R 60806	876504915300	MSW SI 0414 2,2 MOHM VDE
R 61508	879005005400	ESTR.SK10-A 22 KOHM LIN
R 61512	870042904900	KSW NB 0207 100 OHM 5% ST
R 61518	870522732100	MOW 0411 100 KOHM 10%
R 61527	870536930100	MOW 0617 15 KOHM 10% LI
R 61533	873506404900	DRW 4 100 OHM 5%
R 62501	876504914500	MSW SI 0414 1 MOHM 5% VDE
R 62502	831100501700	NTC 4,7 OHM 30%
R 62503	831140127500	VDR SIOV-S14K275E2S11M5
R 62549	876634915500	MSW SI 0414 2,7 MOHM 5% LI
R 64003	870240109700	KMW 0411 10 KOHM 10%
R 64006	293035521200	FOKUS-FUSSPUNKTREGLER

SI 52501	831561202700	SI LOET T315MA 250V
SI 60501	831562000300	SI 5X20 T2A L 250V
SI 61521	831562022500	SI LOET T2A 250V
SI 61524	831562102700	SI LOET T2,5A 250V
SI 61538	831561820000	SI LOET T1A 250V
SI 61561	831562022500	SI LOET T2A 250V
SI 61566	831562022500	SI LOET T2A 250V
SI 62501	831562250300	SI 5X20 T3,15A H 250V

T 21511	830340129900	TRANS.BF299 G/PBF259
T 50528	830221054400	TRANS BD544B/ BD538
T 50529	830221054300	TRANS BD543B/ BD537
T 52503	830221068200	TRANS.BD 679A
T 53501	830262533100	TRANS 2SC5331
T 60506	830263829800	TRANS 2SK2699
T 64016	830328763900	TRANS.BC 639
T 64110	830320554800	TRANS BC548B/ BC547B

TC 22503	831001000800	TRIAC BTB08-600CW
----------	--------------	-------------------

POS. NR. POS. NO.	MATERIAL-NR. PART NUMBER	BEZEICHNUNG DESCRIPTION
----------------------	-----------------------------	----------------------------

TR 52501	092468679700	UEBERTRAGER TRANSFORMER
TR 53500	292016800701	DIODEN-SPLIT TRAF0 DIODE SPLIT TRANSFORMER
TR 60500	292015849702	SPERRWANDLERTRAFO REVERSE CONVERTER TRANSFORMER
TR 60801	292016299701	SPERRWANDLERTRAFO REVERSE CONVERTER TRANSFORMER
TR 64001	292014499700	FOKUSSIERUNGSEBERTRAGER FOCUSING TRANSFORMER

POS. NR. POS. NO.	ABB. FIG.	MATERIAL-NR. PART NUMBER	ANZ. QTY.	BEZEICHNUNG ①	DESCRIPTION ②
		297040116700		CHASSIS-FS-STEREO CUC 1838 DIGI 100 KEIN E-TEIL	CHASSIS TV STEREO CUC 1838 DIGI 100 NO SPARE PART
0100.000		295042022200	X	BAUSTEIN SIGNAL / ZF+TUNER	MODULE SIGNAL / IF+TUNER
0400.000		295042034300	X	BAUSTEIN FEATURE	MODULE FEATURE
0451.000		297006521102		HALTER BAUSTEIN	HOLDER MODULE
1000.000		096211130206	4	SICHERUNGSHALTER SI60501/62501	FUSE HOLDER SI60501/62501
1070.000		293050254900		DYN.FOKUSSIERUNGSPLATTE	DYN.FOCUSING BOARD
1074.000		293032300300		FUNKENSTRECKE 1,2KV	SPARK GAP 1.2KV
1075.000		297006540102		HALTER FOKUSPLATTE	HOLDER FOCUS BOARD
2200.000	△	293033994802		NETZ EINBAUGERAETESTECKER	APPLIANCE COUPLER W.CABLE
2400.000		293031530107	2	MONTAGECLIP T53501/60506	MOUNTING CLIP T53501/60506
2410.000		293031530208		MONTAGECLIP IC40510	MOUNTING CLIP IC40510
2420.000		293031531208	8	MONTAGECLIP D53571/53572/ D61516/61521/61524/IC50510/ T50528/50529	MOUNTING CLIP D53571/53572/ D61516/61521/61524/IC50510/ T50528/50529
2430.000		293031531605		MONTAGECLIP T52503	MOUNTING CLIP T52503
2440.000		293031561600		ISOLIERUNG D60019	INSULATION D60019
2445.000		293031561700		ISOLIERUNG D60021	INSULATION D60021
2450.000		293031562000	6	FOLIE WAERMELEITEND D61516/61521/ D61524/IC50510/T50528/50529	FOIL HEAT CONDUCTING D61516/61521/ D61524/IC50510/T50528/50529
2460.000		293031562100		FOLIE WAERMELEITEND D53572	FOIL HEAT CONDUCTING D53572
2470.000		293031562300		FOLIE WAERMELEITEND D53571	FOIL HEAT CONDUCTING D53571
2480.000		293031562800	2	FOLIE WAERMELEITEND D60019/60021	FOIL HEAT CONDUCTING D60019/60021
2490.000		293031563301		FOLIE WAERMELEITEND T60506	FOIL HEAT CONDUCTING T60506

WW.=WAHLWEISE  
X=SIEHE GESONDERTE E-LISTE

WW.=OPTIONAL  
X=SEE SEPARATE PARTS LIST

POS. NR. POS. NO.	MATERIAL-NR. PART NUMBER	BEZEICHNUNG DESCRIPTION	POS. NR. POS. NO.	MATERIAL-NR. PART NUMBER	BEZEICHNUNG DESCRIPTION
C 40502	845299615000	ELKO 2200UF 20% 25V	C 61514	851591103800	FOKO FKP1 100PF 10% 1600V
C 50512	845299614700	ELKO 1000UF 20% 25V	C 61521	865006704600	KERKO HV C 100PF 20% 1KV
C 50526	845299614700	ELKO 1000UF 20% 25V	C 61524	865006704600	KERKO HV C 100PF 20% 1KV
C 53512	851591160200	FOKO FKP1 142PF 2,5% 2000V	C 61561	865006704600	KERKO HV C 100PF 20% 1KV
C 53571	851591471900	FOKO FKP1 0,012UF 3,5% 2000V	C 61562	845209701500	ELKO #39 1000UF +50-20% 25V
C 60506	865006704600	KERKO HV C 100PF 20% 1KV	C 61563	845209701500	ELKO #39 1000UF +50-20% 25V
C 60509	851591104000	FOKO FKP1 220PF 10% 1600V	C 61566	865006704600	KERKO HV C 100PF 20% 1KV
C 60512	865008111100	KERKO HV C 270PF 20% 2KV	C 62501	851179304700	FOKO MP3/KT 0,47UF20% 275VW
C 60518	851591140300	FOKO FKP1 0,01UF 5% 1250V	C 62502	851179304700	FOKO MP3/KT 0,47UF20% 275VW
C 60519	865006704600	KERKO HV C 100PF 20% 1KV	C 62521	866009823400	KERKO SI 1000PF 20% 400V
C 60521	865006704600	KERKO HV C 100PF 20% 1KV	C 62548	866009823800	KERKO SI 2200PF 20% 400V
C 60523	865008112500	KERKO HV C 100PF 20% 1KV	C 62549	866009823400	KERKO SI 1000PF 20% 400V
C 60524	865008112500	KERKO HV C 100PF 20% 1KV	C 64006	851591160500	FOKO FKP1 220PF 5% 2000V
C 60526	865008112500	KERKO HV C 100PF 20% 1KV	CD 21501	833050414800	MELF DIODE MCL4148
C 60527	865008112500	KERKO HV C 100PF 20% 1KV	CD 21502	833050414800	MELF DIODE MCL4148
C 60528	844330315000	ELKO SNT #3 150UF 20% 450V	CD 21503	833050414800	MELF DIODE MCL4148
C 60529	851179301800	FOKO MP3 0,1UF 20% 275VW	CD 21506	832531310300	MELF DIODE BAV103
C 60801	865006703100	KERKO HV C 47PF 20% 2KV	CD 21666	833050414800	MELF DIODE MCL4148
C 60802	865008112500	KERKO HV C 1000PF 20% 1KV	CD 40536	833050414800	MELF DIODE MCL4148
C 61511	865006704600	KERKO HV C 100PF 20% 1KV	CD 52503	833050414800	MELF DIODE MCL4148
C 61512	865006704600	KERKO HV C 100PF 20% 1KV			

Es gelten die Vorschriften und Sicherheitshinweise gemäß dem Service Manual "Sicherheit", Mat.-Nummer 720108000000, sowie zusätzlich die eventuell abweichenden, landesspezifischen Vorschriften!



The regulations and safety instructions shall be valid as provided by the "Safety" Service Manual, part number 720108000000, as well as the respective national deviations.

ÄNDERUNGEN VORBEHALTEN / SUBJECT TO ALTERATION

ÄNDERUNGEN VORBEHALTEN / SUBJECT TO ALTERATION





Ersatzteilliste  
Spare Parts List

7 / 2002

CHASSIS-FS-STEREO DIGI 100 CUC 1838  
CHASSIS TV STEREO DIGI 100 CUC 1838

MATERIAL-NR. / PART NO.: 297040190200

POS. NR. POS. NO.	MATERIAL-NR. PART NUMBER	BEZEICHNUNG DESCRIPTION
----------------------	-----------------------------	----------------------------

OK 22505	830600036200	OPTOKOPPLER
OK 22505	830600024200	WW. OPTOKOPPLER
OK 60531	830600001200	OPTOKOPPLER
OK 60546	830600001200	OPTOKOPPLER
OK 60805	830600061500	OPTOKOPPLER OPTO COUPLER
R 21512	870000754900	KSW 0207 1,5 MOHM 5%
R 21523	870532901900	MOW 0411 5,6 OHM 5%
R 22501	831120001800	PTC DUO B59709-T60-A110
R 22504	870004912100	KSW 0411 100 KOHM 5%
R 22506	870022905700	KSW NB 0207 220 OHM 5%
R 40502	873229600900	DRW 6,5 2,2 OHM 10%
R 50507	876642460600	MSW 0207 1,6 OHM 1%
R 50508	876642460600	MSW 0207 1,6 OHM 1%
R 50526	870042900500	KSW NB 0207 1,5 OHM 5%
R 50529	876635705900	MSW 0414 270 OHM 5%
R 52501	870532901700	MOW 0411 4,7 OHM 5%
R 52503	873023923900	DRW SI ST7 3W 39 OHM 5%
R 52505	870536901300	MOW 0617 3,3 OHM 5%
R 52506	870536000800	MOW 0617 3,9 OHM 5%
R 53508	870042909700	KSW NB 0207 10 KOHM 5%
R 53511	870522702100	MOW 0411 6,8 OHM 5%
R 53516	873028002100	DRW SI S11 7W 6,8 OHM 5%
R 53521	870536906300	MOW 0617 390 OHM 5%
R 54501	873500303300	DRW 0,75W 0,33 OHM 10%
R 54511	873500303300	DRW 0,75W 0,33 OHM 10%
R 55512	870536906500	MOW 0617 470 OHM 5%
R 55514	870123081700	NKS 3 4,7 OHM 5%
R 58501	876519810400	MSW 0207 20 KOHM 1%
R 58524	870001134500	KSW 0204 1 MOHM 5%
R 60502	870006935600	KSW 0617 3 MOHM 2%
R 60504	870006934100	KSW 0617 680 KOHM 2%
R 60508	873506730100	DRW 7 15 KOHM 10%
R 60512	870000743200	KSW 0207 20 OHM 5%
R 60801	876521212700	MSW 0411 180 KOHM 5%
R 60802	831140107400	VDR SIOV-S07K385GS3
R 60803	870042904500	KSW NB 0207 68 OHM 5%
R 60804	870000740100	KSW 0207 1 OHM 5%
R 60806	876504915300	MSW SI 0414 2,2 MOHM
R 61508	879005005400	ESTR.SK10-A 22 KOHM LIN
R 61512	870042904900	KSW NB 0207 100 OHM 5%
R 61518	870522732100	MOW 0411 100 KOHM 10%
R 61527	870536930100	MOW 0617 15 KOHM 10%
R 61533	873506404900	DRW 4 100 OHM 5%
R 62501	876504914500	MSW SI 0414 1 MOHM 5%
R 62502	831100501700	NTC 4,7 OHM 30%
R 62503	831140127500	VDR SIOV-S14K275E2S11M5
R 62549	876634915500	MSW SI 0414 2,7 MOHM 5%
SI 52501	831561202700	SI LOET T315MA 250V
SI 60501	831562000300	SI 5X20 T2A L 250V
SI 61521	831562022500	SI LOET T2A 250V
SI 61524	831562102700	SI LOET T2,5A 250V
SI 61538	831561820000	SI LOET T1A 250V
SI 61561	831562022500	SI LOET T2A 250V
SI 61566	831562022500	SI LOET T2A 250V
SI 62501	831562250300	SI 5X20 T3,15A H 250V
T 50528	830221054400	TRANS BD544B
T 50529	830221054300	TRANS BD543B
T 52503	830221068200	TRANS BD679A
T 53501	830262533100	TRANS 2SC5331
T 60506	830263829800	TRANS 2SK2699
T 64016	830328763900	TRANS BC639
T 64110	830320554800	TRANS BC548B/BC547B

POS. NR. POS. NO.	MATERIAL-NR. PART NUMBER	BEZEICHNUNG DESCRIPTION
----------------------	-----------------------------	----------------------------

TC 22503	831001000800	TRIAC BTB08-600CW F17
TR 52501	092468679700	UEBERTRAGER TRANSFORMER DRIVER
TR 53500	292016800601	DIODEN-SPLIT TRAF0 TRANSFORMER DIODE SPLIT
TR 60500	292015849702	SPERRWANDLERTRAF0 SPERRWANDLERTRAF0
TR 60801	292016299701	STANDBY B.O.TYPE CONVERTER TRANSFORMER STANDBY
TR 64001	292014499700	FOKUSSIERUNGSUEBERTRAGER FOCUSING TRANSFORMER

POS. NR. POS. NO.	ABB. FIG.	MATERIAL-NR. PART NUMBER	ANZ. QTY.	BEZEICHNUNG ①	DESCRIPTION ②
		297040190200		CHASSIS-FS-STEREO DIGI 100 CUC 1838 KEIN E-TEIL	CHASSIS TV STEREO DIGI 100 CUC 1838 NO SPARE PART
0200.000		295042022400	X	BAUSTEIN SIGNAL/ZF+TUNER	MODULE SIGNAL/IF+TUNER
0400.000		295042032300	X	BAUSTEIN FEATURE	MODULE FEATURE
0450.000		297006521102		HALTER BAUSTEIN	HOLDER MODULE
0450.000		297006540102		HALTER FOKUSPLATTE	HOLDER FOCUS BOARD
0900.000	△	292013610400		FOKUS U.UG2-REGLER	FOCUS AND UG2-CONTROLLER
0910.000		292107030200		FOKUSLEITUNG	FOCUS CABLE
0920.000		297006400100		KLAMMER REGLER	CLAMP CONTROL
1000.000		096211130206	4	SICHERUNGSHALTER SI60501/62501	FUSE HOLDER SI60501/62501
		293050254300		DYN.FOKUSSIERUNGSPLATTE KEIN E-TEIL	DYN.FOCUSING BOARD NO SPARE PART
2200.000	△	293033994802		NETZ EINBAUGERAETESTECKER	APPLIANCE COUPLER
2400.000		293031530107	2	MONTAGECLIP T53501/60506	MOUNTING CLIP T53501/60506
2410.000		293031530208		MONTAGECLIP IC40510	MOUNTING CLIP IC 40510
2430.000		293031531208	8	MONTAGECLIP D53571/53572/61516/ 61521/61524/IC50510/T50528/50529	MOUNTING CLIP D53571/53572/61516/ 61521/61524/IC50510/T50528/50529
2430.000		293031531802	WW. 8	MONTAGECLIP D53571/53572/61516/ 61521/61524/IC 50510/T50528/50529	MOUNTING CLIP D53571/53572/61516/ 61521/61524/IC50510/T50528/50529
2450.000		293031531605		MONTAGECLIP T52503	MOUNTING CLIP T52503
2455.000		293031561600	2	ISOLIERUNG D60019/60021	INSULATING D60019/60021
2455.000		293031561700	WW. 2	ISOLIERUNG D60019/60021	INSULATING D60019/60021
2470.000		293031562000	6	FOLIE WAERMELEITEND D61516/ 61521/61524/IC50510/T50528/50529	FOIL HEAT CONDUCTING D61516/ 61521/61524/IC50510/T50528/50529
2480.000		293031562100	2	FOLIE WAERMELEITEND D53571/53572	FOIL HEAT CONDUCTING D53571/53572
2485.000		293031562300		FOLIE WAERMELEITEND T53501	FOIL HEAT CONDUCTING T53501
2490.000		293031562800	2	FOLIE WAERMELEITEND D60019/60021	FOIL HEAT CONDUCTING D60019/60021
2495.000		293031563301		FOLIE WAERMELEITEND T60506	FOIL HEAT CONDUCTING T60506
				X = SIEHE GESONDERTE E-LISTE WW. = WAHLWEISE	X = SEE SEPARATE PARTS LIST WW. = OPTIONAL

POS. NR. POS. NO.	MATERIAL-NR. PART NUMBER	BEZEICHNUNG DESCRIPTION
----------------------	-----------------------------	----------------------------

C 40502	845299615000	ELKO 2200UF 20% 25V
C 50512	845299614700	ELKO 1000UF 20% 25V
C 50526	845299614700	ELKO 1000UF 20% 25V
C 53512	851591160200	FOKO FKP1 142PF 2,5% 2000V
C 53571	851591471900	FOKO FKP1 0,012UF 3,5% 2000V
C 60506	865006704600	KERKO HV C 100PF 20% 1KV
C 60509	851591104000	FOKO FKP1 220PF 10% 1600V
C 60512	865008111100	KERKO HV C 270PF 20% 2KV
C 60518	851591140300	FOKO FKP1 0,01UF 5% 1250V
C 60519	865006704600	KERKO HV C 100PF 20% 1KV
C 60521	865006704600	KERKO HV C 100PF 20% 1KV
C 60523	865008112500	KERKO HV C 1000PF 20% 1KV
C 60524	865008112500	KERKO HV C 1000PF 20% 1KV
C 60526	865008112500	KERKO HV C 1000PF 20% 1KV
C 60527	865008112500	KERKO HV C 1000PF 20% 1KV
C 60528	844330315000	ELKO SNT #3 150UF 20% 450V

POS. NR. POS. NO.	MATERIAL-NR. PART NUMBER	BEZEICHNUNG DESCRIPTION
----------------------	-----------------------------	----------------------------

C 60529	851179301800	FOKO MP3 0,1UF 20% 275V
C 60801	865006703100	KERKO HV C 47PF 20% 2KV
C 60802	865008112500	KERKO HV C 1000PF 20% 1KV
C 61511	865006704600	KERKO HV C 100PF 20% 1KV
C 61512	865006704600	KERKO HV C 100PF 20% 1KV
C 61514	851591103800	FOKO FKP1 100PF 10% 1600V
C 61521	865006704600	KERKO HV C 100PF 20% 1KV
C 61522	845209705500	ELKO #16 600/680UF +50-20% 63V
C 61524	865006704600	KERKO HV C 100PF 20% 1KV
C 61561	865006704600	KERKO HV C 100PF 20% 1KV
C 61562	845209701500	ELKO #39 1000UF +50-20% 25V
C 61563	845209701500	ELKO #39 1000UF +50-20% 25V
C 61566	865006704600	KERKO HV C 100PF 20% 1KV
C 62501	851179304700	FOKO MP3/KT 0,47UF20% 275V
C 62502	851179304700	FOKO MP3/KT 0,47UF20% 275V
C 62521	866009823400	KERKO SI 1000PF 20% 400V

Es gelten die Vorschriften und Sicherheitshinweise gemäß dem Service Manual "Sicherheit", Mat.-Nummer 720108000000, sowie zusätzlich die eventuell abweichenden, landesspezifischen Vorschriften!



The regulations and safety instructions shall be valid as provided by the "Safety" Service Manual, part number 720108000000, as well as the respective national deviations.

ÄNDERUNGEN VORBEHALTEN / SUBJECT TO ALTERATION

ÄNDERUNGEN VORBEHALTEN / SUBJECT TO ALTERATION





POS. NR. POS. NO.	MATERIAL-NR. PART NUMBER	BEZEICHNUNG DESCRIPTION
----------------------	-----------------------------	----------------------------

OK 22505	830600024200	OPTOKOPPLER
OK 22505	830600036200	WW. OPTOKOPPLER
OK 60531	830600001200	OPTOKOPPLER
OK 60546	830600001200	OPTOKOPPLER
OK 60805	830600061500	OPTOKOPPLER
		OPTO COUPLER
R 21512	870000754900	KSW 0207 1,5 MOHM 5%
R 21523	870532901900	MOW 0411 5,6 OHM 5%
R 22501	831120001800	PTC DUO B59709-T60-A110
R 22506	870022905700	KSW NB 0207 220 OHM 5%
R 40502	873229600900	DRW 6,5 2,2 OHM 10%
R 50507	876642460600	MSW 0207 1,6 OHM 1%
R 50508	876642460600	MSW 0207 1,6 OHM 1%
R 50526	870042900500	KSW NB 0207 1,5 OHM 5%
R 50529	876635705900	MSW 0414 270 OHM 5%
R 52501	870532901700	MOW 0411 4,7 OHM 5%
R 52503	873023923900	DRW SI ST7 3W 39 OHM 5%
R 52505	870536901300	MOW 0617 3,3 OHM 5%
R 52506	870536000800	MOW 0617 3,9 OHM 5%
R 53508	870042909700	KSW NB 0207 10 KOHM 5%
R 53511	870522702100	MOW 0411 6,8 OHM 5%
R 53516	873028002100	DRW SI S11 7W 6,8 OHM 5%
R 53521	870536906300	MOW 0617 390 OHM 5%
R 54501	873500303300	DRW 0,75W 0,33 OHM 10%
R 54511	873500303300	DRW 0,75W 0,33 OHM 10%
R 55512	870536906500	MOW 0617 470 OHM 5%
R 55514	870123081700	NKS 3 4,7 OHM 5%
R 58501	876519810400	MSW 0207 20 KOHM 1%
R 58524	870001134500	KSW 0204 1 MOHM 5%
R 60502	870006935600	KSW 0617 3 MOHM 2%
R 60504	870006934100	KSW 0617 680 KOHM 2%
R 60508	873506730100	DRW 7 15 KOHM 10%
R 60512	870000743200	KSW 0207 20 OHM 5%
R 60802	831140107400	VDR SIOV-S07K385GS3
R 60803	870042904500	KSW NB 0207 68 OHM 5%
R 60804	870000740100	KSW 0207 1 OHM 5%
R 60806	876504915300	MSW SI 0414 2,2 MOHM
R 61508	879005005400	ESTR.SK10-A 22 KOHM LIN
R 61512	870042904900	KSW NB 0207 100 OHM 5%
R 61518	870522732100	MOW 0411 100 KOHM 10%
R 61527	870536930100	MOW 0617 15 KOHM 10%
R 61533	873506404900	DRW 4 100 OHM 5%
R 62501	876504914500	MSW SI 0414 1 MOHM 5%
R 62502	831100501700	NTC 4,7 OHM 30%
R 62503	831140127500	VDR SIOV-S14K275E2S11M5
R 62549	876634915500	MSW SI 0414 2,7 MOHM 5%
SI 52501	831561202700	SI LOET T315MA 250V
SI 60501	831562000300	SI 5X20 T2A L 250V
SI 61521	831562022500	SI LOET T2A 250V
SI 61524	831562102700	SI LOET T2,5A 250V
SI 61538	831561820000	SI LOET T1A 250V
SI 61561	831562022500	SI LOET T2A 250V
SI 61566	831562022500	SI LOET T2A 250V
SI 62501	831562250300	SI 5X20 T3,15A H 250V
T 50528	830221054400	TRANS BD544B
T 50529	830221054300	TRANS BD543B
T 52503	830221068200	TRANS BD679A
T 53501	830262533100	TRANS 2SC5331
T 60506	830263829800	TRANS 2SK2699
T 64016	830328763900	TRANS BC639
T 64110	830320554800	TRANS BC548B/BC547B
TC 22503	831001000800	TRIAC BTB08-600CW F17

POS. NR. POS. NO.	MATERIAL-NR. PART NUMBER	BEZEICHNUNG DESCRIPTION
----------------------	-----------------------------	----------------------------

TR 52501	092468679700	UEBERTRAGER
		TRANSFORMER DRIVER
TR 53500	292016800601	DIODEN-SPLIT TRAFU
		TRANSFORMER DIODE SPLIT
TR 60500	292015849702	SPIERRWANDLERTRAFU
TR 60801	292016299701	SPIERRWANDLERTRAFU
		STANDBY
		B.O. TYPE CONVERTER
		TRANSFORMER STANDBY
TR 64001	292014499700	FOKUSSIERUNGSUEBERTRAGER
		FOCUSING TRANSFORMER

Ersatzteilliste  
Spare Parts List

7 / 2002

CHASSIS-FS-STEREO DIGI 100 CUC 1838  
CHASSIS TV STEREO DIGI 100 CUC 1838

MATERIAL-NR. / PART NO.: 297040190400

POS. NR. POS. NO.	ABB. FIG.	MATERIAL-NR. PART NUMBER	ANZ. QTY.	BEZEICHNUNG ①	DESCRIPTION ②
		297040190400		CHASSIS-FS-STEREO DIGI 100 CUC 1838 KEIN E-TEIL	CHASSIS TV STEREO DIGI 100 CUC 1838 NO SPARE PART
0200.000		295042622400	X	BAUSTEIN SIGNAL/ZF+TUNER	MODULE SIGNAL/IF+TUNER
0400.000		295042032300	X	BAUSTEIN FEATURE	MODULE FEATURE
0450.000		297006540102		HALTER FOKUSPLATTE	HOLDER FOCUS BOARD
0450.000		297006521102		HALTER BAUSTEIN	HOLDER MODULE
0900.000	△	292013610400		FOKUS U.UG2-REGLER	FOCUS AND UG2-CONTROLLER
0910.000		292107030200		FOKUSLEITUNG	FOCUS CABLE
0920.000		297006400100		KLAMMER REGLER	CLAMP CONTROL
1000.000		096211130206	4	SICHERUNGSHALTER SI60501/62501	FUSE HOLDER SI60501/62501
1025.000		293050254300		DYN.FOKUSSIERUNGSPLATTE KEIN E-TEIL	DYN.FOCUSING BOARD NO SPARE PART
2200.000	△	293033994802		NETZ EINBAUGERAETESTECKER	APPLIANCE COUPLER
2400.000		293031530107	2	MONTAGECLIP T53501/60506	MOUNTING CLIP T53501/60506
2410.000		293031530208		MONTAGECLIP IC40510	MOUNTING CLIP IC 40510
2430.000		293031531208	8	MONTAGECLIP D53571/53572/61516/ 61521/61524/IC50510/T50528/50529	MOUNTING CLIP D53571/53572/61516/ 61521/61524/IC50510/T50528/50529
2430.000		293031531802	8	WW. MONTAGECLIP D53571/53572/61516/ 61521/61524/IC 50510/T50528/50529	MOUNTING CLIP D53571/53572/61516/ 61521/61524/IC50510/T50528/50529
2450.000		293031531605		MONTAGECLIP T52503	MOUNTING CLIP T52503
2455.000		293031561600	2	ISOLIERUNG D60019/60021	INSULATION D60019/60021
2455.000		293031561700	2	WW. ISOLIERUNG D60019/60021	INSULATION D60019/60021
2470.000		293031562000	6	FOLIE WAERMELEITEND D61516/ 61521/61524/IC50510/T50528/50529	FOIL HEAT CONDUCTING D61516/ 61521/61524/IC50510/T50528/50529
2480.000		293031562100	2	FOLIE WAERMELEITEND D53571/53572	FOIL HEAT CONDUCTING D53571/53572
2485.000		293031562300		FOLIE WAERMELEITEND T53501	FOIL HEAT CONDUCTING T53501
2490.000		293031562800	2	FOLIE WAERMELEITEND D60019/60021	FOIL HEAT CONDUCTING D60019/60021
2495.000		293031563301		FOLIE WAERMELEITEND T60506	FOIL HEAT CONDUCTING T60506
				X = SIEHE GESONDERTE E-LISTE WW. = WAHLWEISE	X = SEE SEPARATE PARTS LIST WW. = OPTIONAL

POS. NR. POS. NO.	MATERIAL-NR. PART NUMBER	BEZEICHNUNG DESCRIPTION
----------------------	-----------------------------	----------------------------

C 40502	845299615000	ELKO 2200UF 20% 25V
C 50512	845299614700	ELKO 1000UF 20% 25V
C 50526	845299614700	ELKO 1000UF 20% 25V
C 53512	851591160200	FOKO FKP1 142PF 2,5% 2000V
C 53571	851591471900	FOKO FKP1 0,012UF 3,5% 2000V
C 60506	865006704600	KERKO HV C 100PF 20% 1KV
C 60509	851591104000	FOKO FKP1 220PF 10% 1600V
C 60512	865008111100	KERKO HV C 270PF 20% 2KV
C 60518	851591140300	FOKO FKP1 0,01UF 5% 1250V
C 60519	865006704600	KERKO HV C 100PF 20% 1KV
C 60521	865006704600	KERKO HV C 100PF 20% 1KV
C 60523	865008112500	KERKO HV C 1000PF 20% 1KV
C 60524	865008112500	KERKO HV C 1000PF 20% 1KV
C 60526	865008112500	KERKO HV C 1000PF 20% 1KV
C 60527	865008112500	KERKO HV C 1000PF 20% 1KV
C 60528	844330315000	ELKO SNT #3 150UF 20% 450V

POS. NR. POS. NO.	MATERIAL-NR. PART NUMBER	BEZEICHNUNG DESCRIPTION
----------------------	-----------------------------	----------------------------

C 60529	851179301800	FOKO MP3 0,1UF 20% 275V
C 60801	865006703100	KERKO HV C 47PF 20% 2KV
C 60802	865008112500	KERKO HV C 1000PF 20% 1KV
C 61511	865006704600	KERKO HV C 100PF 20% 1KV
C 61512	865006704600	KERKO HV C 100PF 20% 1KV
C 61514	851591103800	FOKO FKP1 100PF 10% 1600V
C 61521	865006704600	KERKO HV C 100PF 20% 1KV
C 61522	845209705500	ELKO #16 600/680UF +50-20% 63V
C 61524	865006704600	KERKO HV C 100PF 20% 1KV
C 61561	865006704600	KERKO HV C 100PF 20% 1KV
C 61562	845209701500	ELKO #39 1000UF +50-20% 25V
C 61563	845209701500	ELKO #39 1000UF +50-20% 25V
C 61566	865006704600	KERKO HV C 100PF 20% 1KV
C 62501	851179304700	FOKO MP3/KT 0,47UF20% 275V
C 62502	851179304700	FOKO MP3/KT 0,47UF20% 275V
C 62521	866009823400	KERKO SI 1000PF 20% 400V

Es gelten die Vorschriften und Sicherheitshinweise gemäß dem Service Manual "Sicherheit", Mat.-Nummer 720108000000, sowie zusätzlich die eventuell abweichenden, landesspezifischen Vorschriften!



The regulations and safety instructions shall be valid as provided by the "Safety" Service Manual, part number 720108000000, as well as the respective national deviations.

ÄNDERUNGEN VORBEHALTEN / SUBJECT TO ALTERATION

ÄNDERUNGEN VORBEHALTEN / SUBJECT TO ALTERATION







POS. NR. MATERIAL-NR. BEZEICHNUNG  
POS. NO. PART NUMBER DESCRIPTION

C 62502  $\Delta$  851179304700 FOKO MP3/KT 0.47UF20% 275V  
C 62521  $\Delta$  866009823400 KERKO SI 1000PF 20% 400V  
C 62548  $\Delta$  866009823800 KERKO SI 2200PF 20% 400V  
C 62549  $\Delta$  866009823400 KERKO SI 1000PF 20% 400V

CD 21501 833050414800 MELF DIODE MCL4148  
CD 21502 833050414800 MELF DIODE MCL4148  
CD 21503 833050414800 MELF DIODE MCL4148  
CD 21506 832531310300 MELF DIODE BAV103  
CD 21666 833050414800 MELF DIODE MCL4148  
CD 40536 833050414800 MELF DIODE MCL4148  
CD 52503 833050414800 MELF DIODE MCL4148  
CD 53519 833050414800 MELF DIODE MCL4148  
CD 55503 830945504400 MELF Z-DIODE 4,3B 0,5W  
CD 55504 833050414800 MELF DIODE MCL4148  
CD 57501 833050414800 MELF DIODE MCL4148  
CD 57503 833050414800 MELF DIODE MCL4148  
CD 57504 833050414800 MELF DIODE MCL4148  
CD 57506 830945515000 MELF Z-DIODE 15VB 0,5W  
CD 58501 833050414800 MELF DIODE MCL4148  
CD 58504 833050414800 MELF DIODE MCL4148  
CD 58507 830945502800 MELF Z-DIODE 2,7B 0,5W  
CD 58511 833050414800 MELF DIODE MCL4148  
CD 58512 833050414800 MELF DIODE MCL4148  
CD 58521 833050414800 MELF DIODE MCL4148  
CD 58522 833050414800 MELF DIODE MCL4148  
CD 60811 833010130200 MELF DIODE BAV 302  
CD 60812 832561034100 SMD DIODE STPS340U  
CD 61528 832538430100 SMD Z-DIODE B2X84B30  
CD 61538 832561034100 SMD DIODE STPS340U  
CD 61548 832561034100 SMD DIODE STPS340U  
CD 61558 832561034100 SMD DIODE STPS340U  
CD 70501 830945505100 MELF-Z DIODE 5,1C 0,5W  
CD 85513 830945505200 MELF-Z DIODE 5,1B 0,5W

CIC 21660 830598600000 SMD IC 74LV00

CL 60504 810498233100 SMD DAEMPF-PERLE

CT 21670 830100484800 SMD TRANS BC848B/BC847B  
CT 40531 830100484800 SMD TRANS BC848B/BC847B  
CT 40591 830100484800 SMD TRANS BC848B/BC847B  
CT 44515 830100484800 SMD TRANS BC848B/BC847B  
CT 57506 830100484800 SMD TRANS BC848B/BC847B  
CT 58512 830100484800 SMD TRANS BC848B/BC847B  
CT 60806 830100685800 SMD TRANS BC858C/BC857C  
CT 61585 830100484800 SMD TRANS BC848B/BC847B  
CT 85505 830100385800 SMD TRANS BC858B/BC857B  
CT 85510 830100385800 SMD TRANS BC858B/BC857B

D 21512 830921502000 DIODE 1N4004  
D 40532 830921504500 DIODE 1N4148  
D 50513 830951627200 DIODE BYV27/200  
D 52506 830921502000 DIODE 1N4004  
D 53508 830920100500 DIODE BA157  
D 53519 830970900300 Z DIODE ZY51  
D 53571 830920435900 DIODE BY359 1,50W  
D 53572 830920423000 DIODE BY229-600  
D 54501 830920100500 DIODE BA157  
D 54511 830920100500 DIODE BA157  
D 55512 830972033300 Z DIODE 33C 0,5W  
D 60019 830919780600 DIODE STTA806D1  
D 60019 830919780700 WW. DIODE STTA806D  
D 60021 830919780600 DIODE STTA806D1  
D 60021 830919780700 WW. DIODE STTA806D  
D 60509 830921140600 DIODE SF4006  
D 60512 830951675400 DIODE BYT53B  
D 60523 830856038400 GLR.SKB380C1500  
D 61503 830972009900 Z DIODE 10B 0,5W  
D 61511 830951603800 DIODE BYV38

POS. NR. MATERIAL-NR. BEZEICHNUNG  
POS. NO. PART NUMBER DESCRIPTION

D 61512 830951603800 DIODE BYV38  
D 61516 830951679800 DIODE BYT08 P-1000  
D 61521 830919682000 DIODE STPR820D  
D 61524 830919682000 DIODE STPR820D  
D 61533 830920100500 DIODE BA157  
D 61561  $\Delta$  830951717200 DIODE BYW172D  
D 61562 830921502000 DIODE 1N4004  
D 61563 830921502000 DIODE 1N4004  
D 61566  $\Delta$  830951717200 DIODE BYW172D  
D 61567 830921502000 DIODE 1N4004  
D 61568 830921502000 DIODE 1N4004  
D 85501 830998411600 LE-DIODE L-115WEGW

IC 40510 830536729700 IC TDA7297  
IC 50510 830512597900 IC STV9379A  
IC 55510 830533814500 IC TDA8145  
IC 58510 830520439300 IC LM3393P  
IC 60510 830533464600 IC TDA16846  
IC 60801 830547026400 IC TNY264  
IC 60817 830546543100 IC TS431Z-AP  
IC 61510 830520435700 IC LM358N  
IC 61535 830520497800 IC L4978  
IC 61545 830520497800 IC L4978  
IC 61555 830520497800 IC L4978  
IC 84501 830546123600 IC TSOP1236

L 53501 810498205600 FERRITPERLE HF70 BTL 3,5X  
L 53502 810498205600 FERRITPERLE HF70 BTL 3,5X  
L 53503 810498205600 FERRITPERLE HF70 BTL 3,5X  
L 53511 814050524900 DR A AX-GA 10UH 10%  
L 53512 092401140400 DROSSSEL 1,5 MH

L 53521 292031259500 LINEARITAETSREGLER  
L 53521 292031259700 WW. LINEARITAETSREGLER  
L 53574 092468596601 BRUECKENSPULE M.KERN  
L 55514 092458160100 O/W AUSKOPPELSPULE  
E/W COUPLING COIL

L 60506 810498208100 FERRITPERLE 0,676UH  
L 60507 810498208000 FERRITPERLE 0,676UH  
L 60518 810498208000 FERRITPERLE 0,676UH

L 60528  $\Delta$  292017119700 SPEICHERDROSSEL  
STORAGE CHOKE  
L 60812 814052499200 SIEB-DR 10UH 15%  
FILTER CHOKE

L 61511 810498201400 DAEMPF-PERLE 433003038102  
L 61514 810498201400 DAEMPF-PERLE 433003038102  
L 61521 810498201400 DAEMPF-PERLE 433003038102  
L 61524 810498201400 DAEMPF-PERLE 433003038102

L 61527 814052499200 SIEB-DR 10UH 15%  
L 61538 814052499500 SIEB-DR 330UH  
FILTER CHOKE

L 61548 814052105900 SPEICHER-DR 59UH 2,5A  
L 61548 814052106800 SPEICHER-DR 67UH  
STORAGE CHOKE

L 61549 814052499200 SIEB-DR 10UH 15%  
FILTER CHOKE  
L 61558 814052106800 SPEICHER-DR 67UH  
L 61558 814052106700 SPEICHER-DR EF16 67UH  
L 61558 814052105900 SPEICHER-DR 59UH 2,5A  
STORAGE CHOKE

L 61561 810498201400 DAEMPF-PERLE 433003038102  
L 61566 810498201400 DAEMPF-PERLE 433003038102

L 62501  $\Delta$  295008359700 ENTSTOER-DR 2X22MH  
INTERFERENCE CHOKE

ÄNDERUNGEN VORBEHALTEN / SUBJECT TO ALTERATION

POS. NR. MATERIAL-NR. BEZEICHNUNG  
POS. NO. PART NUMBER DESCRIPTION

OK 22505  $\Delta$  830600024200 OPTOKOPPLER  
OK 22505  $\Delta$  830600038200 WW. OPTOKOPPLER  
OK 60531  $\Delta$  830600001200 OPTOKOPPLER  
OK 60546  $\Delta$  830600001200 OPTOKOPPLER  
OK 60805  $\Delta$  830600061500 OPTOKOPPLER  
OPTO COUPLER

R 21512 870000754900 KSW 0207 1,5 MOHM 5%  
R 21523  $\Delta$  870532901800 MOW 0411 5,1 OHM 5%  
R 22501  $\Delta$  831120001800 PTC DUO B59709-T60-A110  
R 22506  $\Delta$  870022905700 KSW NB 0207 220 OHM 5%  
R 40502  $\Delta$  873229600900 DRW 6,5 2,2 OHM 10%  
R 50507  $\Delta$  876642460400 MSW 0207 1,3 OHM 1%  
R 50508  $\Delta$  876642460400 MSW 0207 1,3 OHM 1%  
R 50526  $\Delta$  870042900500 KSW NB 0207 1,5 OHM 5%  
R 50529  $\Delta$  876635705300 MSW 0414 150 OHM 5%  
R 52501  $\Delta$  870532901700 MOW 0411 4,7 OHM 5%  
R 52503  $\Delta$  873023923900 DRW SI ST7 3W 39 OHM 5%  
R 52505  $\Delta$  870536901700 MOW 0617 4,7 OHM 5%  
R 52506  $\Delta$  870536901700 MOW 0617 4,7 OHM 5%  
R 53508  $\Delta$  870042909700 KSW NB 0207 10 KOHM 5%  
R 53511 870522702100 MOW 0411 6,8 OHM 5%  
R 53516  $\Delta$  873028002100 DRW SI S11 7W 6,8 OHM 5%  
R 53521  $\Delta$  870536906300 MOW 0617 390 OHM 5%  
R 54501  $\Delta$  873500303300 DRW 0,75W 0,33 OHM 10%  
R 54511  $\Delta$  873500303300 DRW 0,75W 0,33 OHM 10%  
R 55512  $\Delta$  870536906500 MOW 0617 470 OHM 5%  
R 55514  $\Delta$  870123081700 NKS 3 4,7 OHM 5%  
R 58501 876519810400 MSW 0207 20 KOHM 1%  
R 58524 870001134500 KSW 0204 1 MOHM 5%  
R 60502 870006935600 KSW 0617 3 MOHM 2%  
R 60504 870006934100 KSW 0617 680 KOHM 2%  
R 60508 873506730100 DRW 7 15 KOHM 10%  
R 60512 870000743200 KSW 0207 20 OHM 5%  
R 60802  $\Delta$  831140107400 VDR SIOV-S07K385GS3  
R 60803  $\Delta$  870042904500 KSW NB 0207 68 OHM 5%  
R 60804 870000740100 KSW 0207 1 OHM 5%  
R 60806  $\Delta$  876504915300 MSW SI 0414 2,2 MOHM  
R 61508 879005005400 ESTR.SK10-A 22 KOHM LIN  
R 61512  $\Delta$  870042904900 KSW NB 0207 100 OHM 5%  
R 61518 870522732100 MOW 0411 100 KOHM 10%  
R 61527  $\Delta$  870536930100 MOW 0617 15 KOHM 10%  
R 61533 873506404900 DRW 4 100 OHM 5%  
R 62501  $\Delta$  876504914500 MSW SI 0414 1 MOHM 5%  
R 62502 831100501700 NTC 4,7 OHM 30%  
R 62503  $\Delta$  831140127500 VDR SIOV-S14K275E2S11M5  
R 62549  $\Delta$  876634915500 MSW SI 0414 2,7 MOHM 5%

SI 52501  $\Delta$  831561202700 SI LOET T315MA 250V  
SI 60501  $\Delta$  831562000300 SI 5X20 T2A L 250V  
SI 61521  $\Delta$  831562022500 SI LOET T2A 250V  
SI 61524  $\Delta$  831562102700 SI LOET T2,5A 250V  
SI 61538  $\Delta$  831561820000 SI LOET T1A 250V  
SI 61561  $\Delta$  831562022500 SI LOET T2A 250V  
SI 61566  $\Delta$  831562022500 SI LOET T2A 250V  
SI 62501  $\Delta$  831562250300 SI 5X20 T3,15A H 250V

T 21511 830340129900 TRANS BF299G  
T 50528 830221054400 TRANS BD544B  
T 50529 830221054300 TRANS BD543B  
T 52503 830221068200 TRANS BD679A  
T 53501 830262533100 TRANS 2SC5331  
T 60506 830263829800 TRANS 2SK2699

TC 22503  $\Delta$  831001000800 TRIAC BTB08-600CW F17

Es gelten die Vorschriften und Sicherheitshinweise  
gemäß dem Service Manual "Sicherheit", Mat.-Num-  
mer 720108000000, sowie zusätzlich die eventuell ab-  
weichenden, landesspezifischen Vorschriften!



The regulations and safety instructions shall be valid  
as provided by the "Safety" Service Manual, part  
number 720108000000, as well as the respective  
national deviations.

ÄNDERUNGEN VORBEHALTEN / SUBJECT TO ALTERATION

Ersatzteilliste Spare Parts List

7 / 2002

CHASSIS-FS-STEREO DIGI 100 CUC 1838 CHASSIS TV STEREO DIGI 100 CUC 1838

MATERIAL-NR. / PART NO.: 297040191100

Table with 4 columns: POS. NR., ABB., MATERIAL-NR., ANZ., BEZEICHNUNG, DESCRIPTION. Contains parts list for chassis FS-Stereo Digi 100 CUC 1838.

Table with 4 columns: POS. NR., MATERIAL-NR., BEZEICHNUNG, POS. NR., MATERIAL-NR., BEZEICHNUNG. Contains detailed parts list for various electronic components.

Table with 3 columns: POS. NR., MATERIAL-NR., BEZEICHNUNG. Contains part numbers and descriptions for diodes.

Table with 3 columns: POS. NR., MATERIAL-NR., BEZEICHNUNG. Contains part numbers and descriptions for various diodes and SMD components.

Table with 3 columns: POS. NR., MATERIAL-NR., BEZEICHNUNG. Contains part numbers and descriptions for diodes and other electronic parts.

Table with 3 columns: POS. NR., MATERIAL-NR., BEZEICHNUNG. Contains part numbers and descriptions for diodes.

Table with 3 columns: POS. NR., MATERIAL-NR., BEZEICHNUNG. Contains part numbers and descriptions for various diodes and SMD components.

Table with 3 columns: POS. NR., MATERIAL-NR., BEZEICHNUNG. Contains part numbers and descriptions for diodes and other electronic parts.

POS. NR. POS. NO.	MATERIAL-NR. PART NUMBER	BEZEICHNUNG DESCRIPTION
----------------------	-----------------------------	----------------------------

OK 22505	830600024200	OPTOKOPPLER
OK 22505	830600036200	WW.OPTOKOPPLER
OK 60531	830600001200	OPTOKOPPLER
OK 60546	830600001200	OPTOKOPPLER
OK 60805	830600061500	OPTOKOPPLER
Q 33046	838243918600	OPTOCOUPLER
		QUARZ #439-9 18,432MHZ
R 21512	870000754900	KSW 0207 1,5 MOHM 5%
R 21523	870532901800	MOW 0411 5,1 OHM 5%
R 22501	831120001800	PTC DUO B59709-T60-A110
R 22506	870022905700	KSW NB 0207 220 OHM 5%
R 40502	873229600900	DRW 6,5 2,2 OHM 10%
R 50507	876642460400	MSW 0207 1,3 OHM 1%
R 50508	876642460400	MSW 0207 1,3 OHM 1%
R 50526	870042900500	KSW NB 0207 1,5 OHM 5%
R 50529	876635705300	MSW 0414 150 OHM 5%
R 52501	870532901700	MOW 0411 4,7 OHM 5%
R 52503	873023923900	DRW SI ST7 3W 39 OHM 5%
R 52505	870536901700	MOW 0617 4,7 OHM 5%
R 52506	870536901700	MOW 0617 4,7 OHM 5%
R 53508	870042909700	KSW NB 0207 10 KOHM 5%
R 53511	870522702100	MOW 0411 6,8 OHM 5%
R 53516	873028002100	DRW SI S11 7W 6,8 OHM 5%
R 53521	870536906300	MOW 0617 390 OHM 5%
R 54501	873500303300	DRW 0,75W 0,33 OHM 10%
R 54511	873500303300	DRW 0,75W 0,33 OHM 10%
R 55512	870536906500	MOW 0617 470 OHM 5%
R 55514	870123081700	NKS 3 4,7 OHM 5%
R 58501	876519810400	MSW 0207 20 KOHM 1%
R 58524	870001134500	KSW 0204 1 MOHM 5%
R 60502	870006935600	KSW 0617 3 MOHM 2%
R 60504	870006934100	KSW 0617 680 KOHM 2%
R 60508	873506730100	DRW 7 15 KOHM 10%
R 60512	870000743200	KSW 0207 20 OHM 5%
R 60802	831140107400	VDR SIOV-S07K385G53
R 60803	870042904500	KSW NB 0207 68 OHM 5%
R 60806	876504915300	MSW SI 0414 2,2 MOHM
R 61508	879005005400	ESTR.SK10-A 22 KOHM LIN
R 61512	870042904900	KSW NB 0207 100 OHM 5%
R 61518	870522732100	MOW 0411 100 KOHM 10%
R 61527	870536930100	MOW 0617 15 KOHM 10%
R 61533	873506404900	DRW 4 100 OHM 5%
R 62501	876504914500	MSW SI 0414 1 MOHM 5%
R 62502	831100501700	NTC 4,7 OHM 30%
R 62503	831140127500	VDR SIOV-S14K275E2S11M5
R 62549	876634915500	MSW SI 0414 2,7 MOHM 5%
SI 52501	831561202700	SI LOET T315MA 250V
SI 60501	831562000300	SI 5X20 T2A L 250V
SI 61521	831562022500	SI LOET T2A 250V
SI 61524	831562102700	SI LOET T2,5A 250V
SI 61538	831561820000	SI LOET T1A 250V
SI 61561	831562022500	SI LOET T2A 250V
SI 61566	831562022500	SI LOET T2A 250V
SI 62501	831562250300	SI 5X20 T3,15A H 250V
T 21511	830340129900	TRANS BF299G
T 50528	830221054400	TRANS BD544B
T 50529	830221054300	TRANS BD543B
T 52503	830221068200	TRANS BD679A
T 53501	830262533100	TRANS 2SC5331
T 60506	830263829800	TRANS 2SK2699
TC 22503	831001000800	TRIAC BTB08-600CWF17

POS. NR. POS. NO.	MATERIAL-NR. PART NUMBER	BEZEICHNUNG DESCRIPTION
----------------------	-----------------------------	----------------------------

Ersatzteilliste  
Spare Parts List

7 / 2002

CHASSIS-FS-STEREO CUC 1838 DIGI 100  
CHASSIS TV STEREO CUC 1838 DIGI 100

MATERIAL-NR. / PART NO.: 297040192100

POS. NR. POS. NO.	ABB. FIG.	MATERIAL-NR. PART NUMBER	ANZ. QTY.	BEZEICHNUNG ①	DESCRIPTION ②
		297040192100		CHASSIS-FS-STEREO CUC 1838 DIGI 100 KEIN E-TEIL	CHASSIS TV STEREO CUC 1838 DIGI 100 NO SPARE PART
0100.000		295042622400	X	BAUSTEIN SIGNAL / ZF+TUNER	MODULE SIGNAL / IF TUNER
0216.000		297033571100		TASTSCHALTER PROGRAMM+	KEY SWITCH PROGRAMME+
0216.000		297033571100		TASTSCHALTER PROGRAMM-	KEY SWITCH PROGRAMME-
0216.000		297033571100		TASTSCHALTER LAUTSTAERKE+	KEY SWITCH VOLUME+
0216.000		297033571100		TASTSCHALTER LAUTSTAERKE-	KEY SWITCH VOLUME-
0240.000		293033904200		KOPFHOERERBUCHSE 3,5 O.SCHALTER	HEADPHONE SOCKET 3,5 W/O SWITCH
0241.000		293031689401		CINCH-BUCHSE 3-FACH FBAS/NF L,R	CINCH SOCKET 3 FOLD FBAS/AF L,R
0400.000		295042032100	X	BAUSTEIN FEATURE	MODULE FEATURE
0451.000		297006521102		HALTER BAUSTEIN	HOLDER MODULE
1000.000		096211130206	4	SICHERUNGSHALTER SI60501/62501	FUSE HOLDER SI60501/62501
2000.000		297033910100		NETZSCHALTER O.WISCHER	POWER SWITCH W/O WIPER
2200.000		293033994802		NETZ EINBAUGERAETESTECKER	APPLIANCE COUPLER W.CABLE
2400.000		293031530107	2	MONTAGECLIP T53501/60506	MOUNTING CLIP T53501/60506
2410.000		293031530208		MONTAGECLIP IC40510	MOUNTING CLIP IC40510
2420.000		293031531208	8	MONTAGECLIP D53571/53572/ D61516/61521/61524/IC50510/ T50528/50529	MOUNTING CLIP D53571/53572/ D61516/61521/61524/IC50510/ T50528/50529
2430.000		293031531605		MONTAGECLIP T52503	MOUNTING CLIP T52503
2440.000		293031561600		ISOLIERUNG D60019	INSULATION D60019
2445.000		293031561700		ISOLIERUNG D60021	INSULATION D60021
2450.000		293031562000	6	FOLIE WAERMELEITEND D61516/61521/ D61524/IC50510/T50528/50529	FOIL HEAT CONDUCTING D61516/61521/ D61524/IC50510/T50528/50529
2460.000		293031562100		FOLIE WAERMELEITEND D53572	FOIL HEAT CONDUCTING D53572
2470.000		293031562300		FOLIE WAERMELEITEND D53571	FOIL HEAT CONDUCTING D53571
2480.000		293031562800	2	FOLIE WAERMELEITEND D60019/60021	FOIL HEAT CONDUCTING D60019/60021
2490.000		293031563301		FOLIE WAERMELEITEND T60506	FOIL HEAT CONDUCTING T60506
				WW.=WAHLWEISE X=SIEHE GESONDERTE E-LISTE	WW.=OPTIONAL X=SEE SEPARATE PARTS LIST

POS. NR. POS. NO.	MATERIAL-NR. PART NUMBER	BEZEICHNUNG DESCRIPTION	POS. NR. POS. NO.	MATERIAL-NR. PART NUMBER	BEZEICHNUNG DESCRIPTION
C 40502	845299615000	ELKO 2200UF 20% 25V	C 61511	865006704600	KERKO HV C 100PF 20% 1KV
C 50512	845299614700	ELKO 1000UF 20% 25V	C 61512	865006704600	KERKO HV C 100PF 20% 1KV
C 50526	845299614700	ELKO 1000UF 20% 25V	C 61514	851591103800	FOKO FKP1 100PF 10% 1600V
C 53512	851591160200	FOKO FKP1 142PF 2,5% 2000V	C 61521	865006704600	KERKO HV C 100PF 20% 1KV
C 53571	851591471900	FOKO FKP1 0,012UF 3,5% 2000V	C 61524	865006704600	KERKO HV C 100PF 20% 1KV
C 60506	865006704600	KERKO HV C 100PF 20% 1KV	C 61561	865006704600	KERKO HV C 100PF 20% 1KV
C 60509	851591104000	FOKO FKP1 220PF 10% 1600V	C 61562	845209701500	ELKO #39 1000UF +50-20% 25V
C 60512	865008111100	KERKO HV C 270PF 20% 2KV	C 61563	845209701500	ELKO #39 1000UF +50-20% 25V
C 60518	851591140300	FOKO FKP1 0,01UF 5% 1250V	C 61566	865006704600	KERKO HV C 100PF 20% 1KV
C 60519	865006704600	KERKO HV C 100PF 20% 1KV	C 62501	851179304700	FOKO MP3/KT 0,47UF20% 275VW
C 60521	865006704600	KERKO HV C 100PF 20% 1KV	C 62502	851179304700	FOKO MP3/KT 0,47UF20% 275VW
C 60523	865008112500	KERKO HV C 100PF 20% 1KV	C 62521	866009823400	KERKO SI 1000PF 20% 400V
C 60524	865008112500	KERKO HV C 100PF 20% 1KV	C 62548	866009823800	KERKO SI 2200PF 20% 400V
C 60526	865008112500	KERKO HV C 100PF 20% 1KV	C 62549	866009823400	KERKO SI 1000PF 20% 400V
C 60527	865008112500	KERKO HV C 100PF 20% 1KV			
C 60528	844330315000	ELKO SNT #3 150UF 20% 450V	CD 21501	833050414800	MELF DIODE MCL4148
C 60529	851179301800	FOKO MP3 0,1UF 20% 275VW	CD 21502	833050414800	MELF DIODE MCL4148
C 60801	865006703100	KERKO HV C 47PF 20% 2KV	CD 21503	833050414800	MELF DIODE MCL4148
C 60802	865008112500	KERKO HV C 1000PF 20% 1KV	CD 21506	832531310300	MELF DIODE BAV103

Es gelten die Vorschriften und Sicherheitshinweise gemäß dem Service Manual "Sicherheit", Mat.-Nummer 720108000000, sowie zusätzlich die eventuell abweichenden, landesspezifischen Vorschriften!



The regulations and safety instructions shall be valid as provided by the "Safety" Service Manual, part number 720108000000, as well as the respective national deviations.

ÄNDERUNGEN VORBEHALTEN / SUBJECT TO ALTERATION

ÄNDERUNGEN VORBEHALTEN / SUBJECT TO ALTERATION



Ersatzteilliste  
Spare Parts List

7 / 2002

CHASSIS-FS-STEREO DIGI 100 CUC 1838  
CHASSIS TV STEREO DIGI 100 CUC 1838

ERSETZT AUSGABE 6/2002  
SUBSTITUTE EDITION 6/2002

MATERIAL-NR. / PART NO.: 297040192200

Table with columns: POS. NR., ABB., MATERIAL-NR., ANZ., BEZEICHNUNG, DESCRIPTION. Contains parts list for chassis FS-Stereo Digi 100 CUC 1838.

X = SIEHE GESONDERTE E-LISTE  
WW. = WAHLWEISE  
X = SEE SEPARATE PARTS LIST  
WW. = OPTIONAL

Table with columns: POS. NR., MATERIAL-NR., BEZEICHNUNG, POS. NR., MATERIAL-NR., BEZEICHNUNG. Contains parts list for various electronic components like ELKO, KERKO, FOKO.

ÄNDERUNGEN VORBEHALTEN / SUBJECT TO ALTERATION

Table with columns: POS. NR., MATERIAL-NR., BEZEICHNUNG, POS. NR., MATERIAL-NR., BEZEICHNUNG. Contains parts list for various electronic components like MELF diodes, SMD diodes, and transistors.

ÄNDERUNGEN VORBEHALTEN / SUBJECT TO ALTERATION

POS. NR. POS. NO.	MATERIAL-NR. PART NUMBER	BEZEICHNUNG DESCRIPTION
----------------------	-----------------------------	----------------------------

R 50529	△ 876635705900	MSW 0414 270 OHM 5%
R 52501	△ 870532901700	MOW 0411 4,7 OHM 5%
R 52503	△ 873023923900	DRW SI ST7 3W 39 OHM 5%
R 52505	△ 870536901600	MOW 0617 4,3 OHM 5%
R 52506	△ 870536901600	MOW 0617 4,3 OHM 5%
R 53508	△ 870042909700	KSW NB 0207 10 KOHM 5%
R 53511	△ 870522702100	MOW 0411 6,8 OHM 5%
R 53516	△ 873028002100	DRW SI S11 7W 6,8 OHM 5%
R 53521	△ 870536906300	MOW 0617 390 OHM 5%
R 54501	△ 873500303300	DRW 0,75W 0,33 OHM 10%
R 55512	△ 870536926700	MOW 0617 560 OHM 10%
R 55514	△ 870123081700	NKS 3 4,7 OHM 5%
R 58501	△ 876519810400	MSW 0207 20 KOHM 1%
R 58524	△ 870001134500	KSW 0204 1 MOHM 5%
R 60502	△ 870006935600	KSW 0617 3 MOHM 2%
R 60504	△ 870006934100	KSW 0617 680 KOHM 2%
R 60508	△ 873506730100	DRW 7 15 KOHM 10%
R 60512	△ 870000743200	KSW 0207 20 OHM 5%
R 60802	△ 831140107400	VDR SIOV-S07K385GS3
R 60803	△ 870042904500	KSW NB 0207 68 OHM 5%
R 60804	△ 870000740100	KSW 0207 1 OHM 5%
R 60806	△ 876504915300	MSW SI 0414 2,2 MOHM
R 61508	△ 879005005400	ESTR.SK10-A 22 KOHM LIN
R 61512	△ 870042904900	KSW NB 0207 100 OHM 5%
R 61518	△ 870522732100	MOW 0411 100 KOHM 10%
R 61527	△ 870536930100	MOW 0617 15 KOHM 10%
R 61533	△ 873506404900	DRW 4 100 OHM 5%
R 62501	△ 876504914500	MSW SI 0414 1 MOHM 5%
R 62502	△ 831100501700	NTC 4,7 OHM 30%
R 62503	△ 831140127500	VDR SIOV-S14K275E2S11M5
R 62549	△ 876634915500	MSW SI 0414 2,7 MOHM 5%
SI 52501	△ 831561202700	SI LOET T315MA 250V
SI 60501	△ 831562000300	SI 5X20 T2A L 250V
SI 61521	△ 831562022500	SI LOET T2A 250V
SI 61524	△ 831562102700	SI LOET T2,5A 250V
SI 61538	△ 831561820000	SI LOET T1A 250V
SI 61561	△ 831562022500	SI LOET T2A 250V
SI 61566	△ 831562022500	SI LOET T2A 250V
SI 62501	△ 831562250300	SI 5X20 T3,15A H 250V

T 50528	830221054400	TRANS BD544B
T 50529	830221054300	TRANS BD543B
T 52503	830221068200	TRANS BD679A
T 53501	830262533100	TRANS 2SC5331
T 60506	830263829800	TRANS 2SK2699

TC 22503	△ 8310011000800	TRIAC BTB08-600CW F17
----------	-----------------	-----------------------

TR 52501	△ 092468679700	UEBERTRAGER VOGT TRANSFORMER DRIVER
TR 53500	△ 292016800300	TRAFO DIODEN-SPLIT TRANSFORMER DIODE SPLIT
TR 60500	△ 292015859701	SPERRWANDLERTRAFO SPERRWANDLERTRAFO
TR 60801	△ 292016299701	STANDBY B.O.TYPE CONVERTER TRANSFORMER STANDBY

POS. NR. POS. NO.	MATERIAL-NR. PART NUMBER	BEZEICHNUNG DESCRIPTION
----------------------	-----------------------------	----------------------------

Ersatzteilliste  
Spare Parts List

7 / 2002

CHASSIS-FS-STEREO CUC 1838 DIGI 100  
CHASSIS TV STEREO CUC 1838 DIGI 100

MATERIAL-NR. / PART NO.: 297040192300

POS. NR. POS. NO.	ABB. FIG.	MATERIAL-NR. PART NUMBER	ANZ. QTY.	BEZEICHNUNG ①	DESCRIPTION ②
		297040192300		CHASSIS-FS-STEREO CUC 1838 DIGI 100 KEIN E-TEIL	CHASSIS TV STEREO CUC 1838 DIGI 100 NO SPARE PART
0100.000		295042022400	X	BAUSTEIN SIGNAL / ZF+TUNER	MODULE SIGNAL / IF TUNER
0400.000		295042032200	X	BAUSTEIN FEATURE	MODULE FEATURE
0451.000		297006521102		HALTER BAUSTEIN	HOLDER MODULE
1000.000		096211130206	4	SICHERUNGSHALTER SI60501/62501	FUSE HOLDER SI60501/62501
2200.000	△	293033994802		NETZ EINBAUGERAETESTECKER	APPLIANCE COUPLER W.CABLE
2400.000		293031530107	2	MONTAGECLIP T53501/60506	MOUNTING CLIP T53501/60506
2410.000		293031530208		MONTAGECLIP IC40510	MOUNTING CLIP IC40510
2420.000		293031531208	8	MONTAGECLIP D53571/53572/ D61516/61521/61524/IC50510/ T50528/50529	MOUNTING CLIP D53571/53572/ D61516/61521/61524/IC50510/ T50528/50529
2430.000		293031531605		MONTAGECLIP T52503	MOUNTING CLIP T52503
2440.000		293031561600		ISOLIERUNG D60019	INSULATION D60019
2445.000		293031561700		ISOLIERUNG D60021	INSULATION D60021
2450.000		293031562000	6	FOLIE WAERMELEITEND D61516/61521/ D61524/IC50510/T50528/50529	FOIL HEAT CONDUCTING D61516/61521/ D61524/IC50510/T50528/50529
2460.000		293031562100		FOLIE WAERMELEITEND D53572	FOIL HEAT CONDUCTING D53572
2470.000		293031562300		FOLIE WAERMELEITEND D53571	FOIL HEAT CONDUCTING D53571
2480.000		293031562800	2	FOLIE WAERMELEITEND D60019/60021	FOIL HEAT CONDUCTING D60019/60021
2490.000		293031563301		FOLIE WAERMELEITEND T60506	FOIL HEAT CONDUCTING T60506
				WW.-WAHLWEISE X=SIEHE GESONDERTE E-LISTE	WW.-OPTIONAL X=SEE SEPARATE PARTS LIST

POS. NR. POS. NO.	MATERIAL-NR. PART NUMBER	BEZEICHNUNG DESCRIPTION
----------------------	-----------------------------	----------------------------

C 40502	845299615000	ELKO 2200UF 20% 25V
C 50512	845299615000	ELKO 2200UF 20% 25V
C 50526	845299865000	ELKO 2200UF 20% 25V
C 53512	851591160200	FOKO FKP1 142PF 2,5% 2000V
C 53571	851591471900	FOKO FKP1 0,012UF 3,5% 2000V
C 60506	865006704600	KERKO HV C 100PF 20% 1KV
C 60509	851591104000	FOKO FKP1 220PF 10% 1600V
C 60512	865008111100	KERKO HV C 270PF 20% 2KV
C 60518	851591140300	FOKO FKP1 0,01UF 5% 1250V
C 60519	865006704600	KERKO HV C 100PF 20% 1KV
C 60521	865006704600	KERKO HV C 100PF 20% 1KV
C 60523	865008112500	KERKO HV C 1000PF 20% 1KV
C 60524	865008112500	KERKO HV C 1000PF 20% 1KV
C 60526	865008112500	KERKO HV C 1000PF 20% 1KV
C 60527	865008112500	KERKO HV C 1000PF 20% 1KV
C 60528	△ 844330315000	ELKO SNT #3 150UF 20% 450V
C 60529	△ 851179301800	FOKO MP3 0,1UF 20% 275VW
C 60801	865006703100	KERKO HV C 47PF 20% 2KV
C 60802	865008112500	KERKO HV C 1000PF 20% 1KV
C 61511	865006704600	KERKO HV C 100PF 20% 1KV
C 61512	865006704600	KERKO HV C 100PF 20% 1KV
C 61514	851591103800	FOKO FKP1 100PF 10% 1600V
C 61521	865006704600	KERKO HV C 100PF 20% 1KV
C 61524	865006704600	KERKO HV C 100PF 20% 1KV
C 61561	865006704600	KERKO HV C 100PF 20% 1KV

POS. NR. POS. NO.	MATERIAL-NR. PART NUMBER	BEZEICHNUNG DESCRIPTION
----------------------	-----------------------------	----------------------------

C 61562	845209701500	ELKO #39 1000UF +50-20% 25V
C 61563	845209701500	ELKO #39 1000UF +50-20% 25V
C 61566	865006704600	KERKO HV C 100PF 20% 1KV
C 62501	△ 851179304700	FOKO MP3/KT 0,47UF20% 275VW
C 62502	△ 851179304700	FOKO MP3/KT 0,47UF20% 275VW
C 62521	△ 866009823400	KERKO SI 1000PF 20% 400V
C 62548	△ 866009823800	KERKO SI 2200PF 20% 400V
C 62549	△ 866009823400	KERKO SI 1000PF 20% 400V
CD 21636	833050414800	MELF DIODE MCL4148
CD 21666	833050414800	MELF DIODE MCL4148
CD 40536	833050414800	MELF DIODE MCL4148
CD 52503	833050414800	MELF DIODE MCL4148
CD 53519	833050414800	MELF DIODE MCL4148
CD 55503	830945504400	MELF Z-DIODE 4,3 B 0,5W
CD 55504	833050414800	MELF DIODE MCL4148
CD 57501	833050414800	MELF DIODE MCL4148
CD 57503	833050414800	MELF DIODE MCL4148
CD 57504	833050414800	MELF DIODE MCL4148
CD 57506	830945515000	MELF Z-DIODE 15V B 0,5W
CD 58501	833050414800	MELF DIODE MCL4148
CD 58504	833050414800	MELF DIODE MCL4148
CD 58507	830945502800	MELF Z-DIODE 2,7 B 0,5W
CD 58511	833050414800	MELF DIODE MCL4148
CD 58512	833050414800	MELF DIODE MCL4148

Es gelten die Vorschriften und Sicherheitshinweise gemäß dem Service Manual "Sicherheit", Mat.-Nummer 720108000000, sowie zusätzlich die eventuell abweichenden, landesspezifischen Vorschriften!



The regulations and safety instructions shall be valid as provided by the "Safety" Service Manual, part number 720108000000, as well as the respective national deviations.

ÄNDERUNGEN VORBEHALTEN / SUBJECT TO ALTERATION

ÄNDERUNGEN VORBEHALTEN / SUBJECT TO ALTERATION

POS. NR. POS. NO.	MATERIAL-NR. PART NUMBER	BEZEICHNUNG DESCRIPTION
CD 58521	833050414800	MELF DIODE MCL4148
CD 58522	833050414800	MELF DIODE MCL4148
CD 60811	833010130200	MELF DIODE BAV 302
CD 60812	832561034100	SMD DIODE STPS340U
CD 61528	832538430100	SMD Z-DIODE BX284B30
CD 61538	832561034100	SMD DIODE STPS340U
CD 61548	832561034100	SMD DIODE STPS340U
CD 61558	832561034100	SMD DIODE STPS340U
CD 70501	830945505200	MELF-Z DIODE 5,1 C 0,5W
CD 85513	830945505200	MELF-Z DIODE 5,1 B 0,5W
CIC 21660	830598600000	SMD IC 74LV00
CL 60504	810498233100	SMD DAEMPF-PERLE 0805
CT 21635	830100685800	SMD TRANS BC858C/ BC857C
CT 21650	830100684800	SMD TRANS BC848C/ BC847C
CT 21658	830100684800	SMD TRANS BC848C/ BC847C
CT 21670	830100484800	SMD TRANS BC848B/ BC847B
CT 40531	830100484800	SMD TRANS BC848B/ BC847B
CT 40591	830100484800	SMD TRANS BC848B/ BC847B
CT 44515	830100484800	SMD TRANS BC848B/ BC847B
CT 57506	830100484800	SMD TRANS BC848B/ BC847B
CT 58512	830100484800	SMD TRANS BC848B/ BC847B
CT 60806	830100685800	SMD TRANS BC858C/ BC857C
CT 61585	830100484800	SMD TRANS BC848B/ BC847B
CT 85505	830100385800	SMD TRANS BC858B/ BC857B
CT 85510	830100385800	SMD TRANS BC858B/ BC857B
D 21512	830921502000	DIODE 1N4004
D 21621	830921504500	DIODE 1N4148
D 21622	830921504500	DIODE 1N4148
D 40532	830921504500	DIODE 1N4148
D 50513	830951627200	DIODE BYV27/200
D 52906	830921502000	DIODE 1N4004
D 53508	830920100500	DIODE BA157
D 53519	830970900300	Z DIODE ZY 51
D 53571	830920435900	DIODE BY359 1500
D 53572	830920423000	DIODE BY 229-600
D 54501	830920100500	DIODE BA157
D 55512	830972033300	Z DIODE 33 C 0,5W
D 60019	830919780700	DIODE STTA806D
D 60021	830919780700	DIODE STTA806D
D 60509	830921140600	DIODE SF4006
D 60512	830951675400	DIODE BYT53B
D 60523	830856038400	GLR.SKB380C1500
D 61503	830972009900	Z DIODE 10 B 0,5W
D 61511	830951603800	DIODE BYV38
D 61512	830951603800	DIODE BYV38
D 61516	830951679800	DIODE BYT 08 P-1000
D 61521	830919682000	DIODE STPR820D
D 61524	830919682000	DIODE STPR820D
D 61533	830920100500	DIODE BA157
D 61561 Δ	830951717200	DIODE BYW172D
D 61566 Δ	830951717200	DIODE BYW172D
IC 40510	830536729700	IC TDA7297
IC 50510	830512597900	IC STV9379A
IC 55510	830533814500	IC TDA8145
IC 58510	830520439300	IC LM393P
IC 60510	830533464700	IC TDA16846-2
IC 60801	830547026400	IC TNY264
IC 60817	830546543100	IC TS431IZ-AP
IC 61510	830520435700	IC LM358N
IC 61535	830520497800	IC L4978
IC 61545	830520497800	IC L4978
IC 61555	830520497800	IC L4978
L 53501	810498205600	FERRITPERLE HF70 BTL 3,5X6
L 53502	810498205600	FERRITPERLE HF70 BTL 3,5X6

POS. NR. POS. NO.	MATERIAL-NR. PART NUMBER	BEZEICHNUNG DESCRIPTION
L 53503	810498205600	FERRITPERLE HF70 BTL 3,5X6 FERRITE BEAD
L 53511	814050524900	DR A AX-GA 10UH 10%
L 53512	092401144040	DROSSEL 1,5 MH/COIL 1,5 MH
L 53521	292031229500	LINEARITAETSPREGLER
L 53521	292031229700	WW. LINEARITAETSPREGLER LINEARITY CONTROL
L 53574	092468595500	BRUECKENSPULE M.KERN BRIDGE COIL W. CORE
L 55514	092458160100	O/W AUSKOPPELSPULE E/W DECOUPLING COIL
L 60506	810498208100	FERRITPERLE 0,676UH LI
L 60507	810498208000	FERRITPERLE 0,676UH
L 60518	810498208000	FERRITPERLE 0,676UH FERRITE BEAD
L 60528 Δ	292017119700	SPEICHERDROSSEL EF25/11 1,8MH STORAGE CHOKE EF25/11 1,8MH
L 60812	814052499200	SIEB-DR 10UH 15% FILTER CHOKE 10UH 15%
L 61511	810498201400	DAEMPF-PERLE 433003038102
L 61514	810498201400	DAEMPF-PERLE 433003038102
L 61521	810498201400	DAEMPF-PERLE 433003038102
L 61524	810498201400	DAEMPF-PERLE 433003038102 DAMPING BEAD
L 61527	814052499200	SIEB-DR 10UH 15% FILTER CHOKE 10UH 15%
L 61538	814052499500	SIEB-DR 330UH FILTER CHOKE 330UH
L 61548	814052106800	SPEICHER-DR 67UH EF16 STORAGE CHOKE 67UH EF16
L 61548	814052105900	WW. SPEICHER-DR 59UH 2,5A STORAGE CHOKE 59UH 2,5A
L 61549	814052499200	SIEB-DR 10UH 15% FILTER CHOKE 10UH 15%
L 61558	814052105900	SPEICHER-DR 59UH 2,5A STORAGE CHOKE 59UH 2,5A
L 61558	814052106700	WW. SPEICHER-DR EF16 67UH 2,5A STORAGE CHOKE EF16 67UH 2,5A
L 61558	814052106800	WW. SPEICHER-DR 67UH EF16 STORAGE CHOKE 67UH EF16
L 61561	810498201400	DAEMPF-PERLE 433003038102 DAMPING BEAD
L 61562	814050506500	DR A AX-GA 47UH 5%
L 61566	810498201400	DAEMPF-PERLE 433003038102 DAMPING BEAD
L 61567	814050506500	DR A AX-GA 47UH 5%
L 62501 Δ	295008359700	ENTSTOER-DR 2X22MH INTERFERENCE CHOKO 2X22MH
OK 22505 Δ	830600024200	OPTOKOPPLER IL4216-X001
OK 22505 Δ	830600036200	WW. OPTOKOPPLER TLP3063
OK 60531 Δ	830600001200	OPTOKOPPLER CNY17F1
OK 60546 Δ	830600001200	OPTOKOPPLER CNY17F1
OK 60805 Δ	830600061500	OPTOKOPPLER SFH615A-2
R 21523 Δ	870532102000	MOW 0411 6,2 OHM 5%
R 22501 Δ	831120001600	PTC DUO T251-A80-A10
R 22504	870004912100	KSW 0411 100 KOHM 5%
R 22506 Δ	870022905700	KSW NB 0207 220 OHM 5%
R 40502 Δ	873229600900	DRW 6,5 2,2 OHM 10%
R 50507 Δ	876642460600	MSW 0207 1,6 OHM 1% ST
R 50508 Δ	876642460600	MSW 0207 1,6 OHM 1% ST
R 50526 Δ	870042900500	KSW NB 0207 1,5 OHM 5%
R 50529 Δ	876635705900	MSW 0414 270 OHM 5%
R 52501 Δ	870532901700	MOW 0411 4,7 OHM 5%
R 52503 Δ	873023923900	DRW SI ST7 3W 39 OHM 5%
R 52505 Δ	870536901600	MOW 0617 4,3 OHM 5% LI
R 52506 Δ	870536901600	MOW 0617 4,3 OHM 5% LI
R 53508 Δ	870042909700	KSW NB 0207 10 KOHM 5% ST
R 53511	870522702100	MOW 0411 6,8 OHM 5%

ÄNDERUNGEN VORBEHALTEN / SUBJECT TO ALTERATION

POS. NR. POS. NO.	MATERIAL-NR. PART NUMBER	BEZEICHNUNG DESCRIPTION
R 53516 Δ	873028002100	DRW SI S11 7W 6,8 OHM 5%
R 53521 Δ	870536906300	MOW 0617 390 OHM 5% LI
R 54501 Δ	873500303300	DRW 0,75W 0,33 OHM 10%
R 55512 Δ	870536926700	MOW 0617 560 OHM 10% LI
R 55514 Δ	870123081700	NKS 3 4,7 OHM 5%
R 58501	876519810400	MSW 0207 20 KOHM 1%
R 60502	870006935600	KSW 0617 3 MOHM 2%
R 60504	870006934100	KSW 0617 680 KOHM 2%
R 60508	873506730100	DRW 7 15 KOHM 10%
R 60512	870000743200	KSW 0207 20 OHM 5%
R 60801	876521212700	MSW 0411 180 KOHM 5%
R 60802 Δ	831140107400	VDR SIOV-S07K385GS3
R 60803 Δ	870042904500	KSW NB 0207 68 OHM 5%
R 60806 Δ	876504915300	MSW SI 0414 2,2 MOHM VDE ESTR.SK10-A 22 KOHM LIN
R 61508	879005005400	
R 61512 Δ	870042904900	KSW NB 0207 100 OHM 5% ST
R 61518	870522732100	MOW 0411 100 KOHM 10%
R 61527 Δ	870536930100	MOW 0617 15 KOHM 10% LI
R 61533	873506404900	DRW 4 100 OHM 5%
R 62501 Δ	876504914500	MSW SI 0414 1 MOHM 5% VDE
R 62502	831100501700	NTC 4,7 OHM 30%
R 62503 Δ	831140127500	VDR SIOV-S14K275E2S11M5
R 62549 Δ	876634915500	MSW SI 0414 2,7 MOHM 5% LI
SI 52501 Δ	831561202700	SI LOET T315MA 250V
SI 60501 Δ	831562000300	SI 5X20 T2A L 250V
SI 61521 Δ	831562022500	SI LOET T2A 250V
SI 61524 Δ	831562102700	SI LOET T2,5A 250V
SI 61538 Δ	831561820000	SI LOET T1A 250V
SI 61561 Δ	831562022500	SI LOET T2A 250V
SI 61566 Δ	831562022500	SI LOET T2A 250V
SI 62501 Δ	831562250300	SI 5X20 T3,15A H 250V
T 50528	830221054400	TRANS BD544B/ BD538
T 50529	830221054300	TRANS BD543B/ BD537
T 52503	830221068200	TRANS.BD 679A
T 53501	830262533100	TRANS 2SC5331
T 60506	830263829800	TRANS 2SK2699
TC 22503Δ	831001000800	TRIAC BTB08-600CW
TR 52501 Δ	092468679700	UEBERTRAGER TRANSFORMER
TR 53500Δ	292016800300	TRAFO DIODEN-SPLIT DIODE SPLIT TRANSFORMER
TR 60500Δ	292015859701	SPERRWANDLERTRAFO REVERSE CONVERTER TRANSFORMER
TR 60801 Δ	292016299701	SPERRWANDLERTRAFO REVERSE CONVERTER TRANSFORMER

Es gelten die Vorschriften und Sicherheitshinweise gemäß dem Service Manual "Sicherheit", Mat.-Nummer 720108000000, sowie zusätzlich die eventuell abweichenden, landesspezifischen Vorschriften!



The regulations and safety instructions shall be valid as provided by the "Safety" Service Manual, part number 720108000000, as well as the respective national deviations.

ÄNDERUNGEN VORBEHALTEN / SUBJECT TO ALTERATION

Ersatzteilliste  
Spare Parts List

6 / 2002

CHASSIS-FS-STEREO DIGI 100 CUC 1838  
CHASSIS TV STEREO DIGI 100 CUC 1838

MATERIAL-NR. / PART NO.: 297040193100

Table with columns: POS. NR. ABB. MATERIAL-NR. ANZ. BEZEICHNUNG, POS. NO. FIG. PART NUMBER QTY. DESCRIPTION. Includes part numbers like 297040193100 and descriptions like CHASSIS-FS-STEREO DIGI 100 CUC 1838.

Table with columns: POS. NR. MATERIAL-NR. BEZEICHNUNG, POS. NO. PART NUMBER DESCRIPTION. Lists various electronic components like ELKO capacitors, KERKO resistors, and FOKO components.

ÄNDERUNGEN VORBEHALTEN / SUBJECT TO ALTERATION

Large table with columns: POS. NR. MATERIAL-NR. BEZEICHNUNG, POS. NO. PART NUMBER DESCRIPTION. Contains multiple columns of part numbers and descriptions, including diodes, capacitors, and other electronic components.

ÄNDERUNGEN VORBEHALTEN / SUBJECT TO ALTERATION

POS. NR. POS. NO.	MATERIAL-NR. PART NUMBER	BEZEICHNUNG DESCRIPTION
----------------------	-----------------------------	----------------------------

R 50526	△ 870042900500	KSW NB 0207 1,5 OHM 5%
R 50529	△ 876635705900	MSW 0414 270 OHM 5%
R 52501	△ 870532901700	MOW 0411 4,7 OHM 5%
R 52503	△ 873023923900	DRW SI ST7 3W 39 OHM 5%
R 52505	△ 870536901600	MOW 0617 4,3 OHM 5%
R 52506	△ 870536901600	MOW 0617 4,3 OHM 5%
R 53508	△ 870042909700	KSW NB 0207 10 KOHM 5%
R 53511	△ 870522702100	MOW 0411 6,8 OHM 5%
R 53516	△ 873028002100	DRW SI S11 7W 6,8 OHM 5%
R 53521	△ 870536906300	MOW 0617 390 OHM 5%
R 54501	△ 873500303300	DRW 0,75W 0,33 OHM 10%
R 54511	△ 873500303300	DRW 0,75W 0,33 OHM 10%
R 55512	△ 870536926700	MOW 0617 560 OHM 10%
R 55514	△ 870123081700	NKS 3 4,7 OHM 5%
R 58501	△ 876519810400	MSW 0207 20 KOHM 1%
R 58524	△ 870001134500	KSW 0204 1 MOHM 5%
R 60502	△ 870006935600	KSW 0617 3 MOHM 2%
R 60504	△ 870006934100	KSW 0617 680 KOHM 2%
R 60508	△ 873506730100	DRW 7 15 KOHM 10%
R 60512	△ 870000743200	KSW 0207 20 OHM 5%
R 60801	△ 876521212700	MSW 0411 180 KOHM 5%
R 60802	△ 831140107400	VDR SIOV-S07K385GS3
R 60803	△ 870042904500	KSW NB 0207 68 OHM 5%
R 60804	△ 870000740100	KSW 0207 1 OHM 5%
R 60806	△ 876504915300	MSW SI 0414 2,2 MOHM
R 61508	△ 879005005400	ESTR.SK10-A 22 KOHM LIN
R 61512	△ 870042904900	KSW NB 0207 100 OHM 5%
R 61518	△ 870522732100	MOW 0411 100 KOHM 10%
R 61527	△ 870536930100	MOW 0617 15 KOHM 10%
R 61533	△ 873506404900	DRW 4 100 OHM 5%
R 62501	△ 876504914500	MSW SI 0414 1 MOHM 5%
R 62502	△ 831100501700	NTC 4,7 OHM 30%
R 62503	△ 831140127500	VDR SIOV-S14K275E2S11M5
R 62549	△ 876634915500	MSW SI 0414 2,7 MOHM 5%
SI 52501	△ 831561202700	SI LOET T315MA 250V
SI 60501	△ 831562000300	SI 5X20 T2A L 250V
SI 61521	△ 831562022500	SI LOET T2A 250V
SI 61524	△ 831562102700	SI LOET T2,5A 250V
SI 61538	△ 831561820000	SI LOET T1A 250V
SI 61561	△ 831562022500	SI LOET T2A 250V
SI 61566	△ 831562022500	SI LOET T2A 250V
SI 62501	△ 831562250300	SI 5X20 T3,15A H 250V
T 50528	830221054400	TRANS BD544B
T 50529	830221054300	TRANS BD543B
T 52503	830221068200	TRANS BD679A
T 53501	830262533100	TRANS 2SC5331
T 60506	830263829800	TRANS 2SK2699

TC 22503△ 831001000800 TRIAC BTB08-600CW F17

TR 52501△	092468679700	UEBERTRAGER TRANSFORMER DRIVER
TR 53500△	292016800300	TRAF0 DIODEN-SPLIT TRANSFORMER DIODE SPLIT
TR 60500△	292015859701	SPERRWANDLERTRAFO
TR 60801△	292016299701	SPERRWANDLERTRAFO STANDBY B.O.TYPE CONVERTER TRANSFORMER STANDBY

Es gelten die Vorschriften und Sicherheitshinweise gemäß dem Service Manual "Sicherheit", Mat.-Nummer 720108000000, sowie zusätzlich die eventuell abweichenden, landesspezifischen Vorschriften!



The regulations and safety instructions shall be valid as provided by the "Safety" Service Manual, part number 720108000000, as well as the respective national deviations.

ÄNDERUNGEN VORBEHALTEN / SUBJECT TO ALTERATION

POS. NR. POS. NO.	MATERIAL-NR. PART NUMBER	BEZEICHNUNG DESCRIPTION
----------------------	-----------------------------	----------------------------

Ersatzteilliste  
Spare Parts List

2 / 2002

CHASSIS-FS-STEREO DIGI 100 CUC 1838  
CHASSIS TV STEREO DIGI 100 CUC 1838

MATERIAL-NR. / PART NO.: 297040193200

POS. NR. POS. NO.	ABB. FIG.	MATERIAL-NR. PART NUMBER	ANZ. QTY.	BEZEICHNUNG Ⓛ	DESCRIPTION Ⓛ
		297040193200		CHASSIS-FS-STEREO DIGI 100 CUC 1838 KEIN E-TEIL	CHASSIS TV STEREO DIGI 100 CUC 1838 NO SPARE PART
0200.000		295042622400	X	BAUSTEIN SIGNAL/ZF+TUNER	MODULE SIGNAL/IF+TUNER
0450.000		297006521102		HALTER BAUSTEIN	HOLDER MODULE
0500.000		295042032200	X	BAUSTEIN FEATURE	MODULE FEATURE
1000.000		096211130206	4	SICHERUNGSHALTER SI60501/62501	FUSE HOLDER SI60501/62501
2200.000	△	293033994802		NETZ EINBAUGERAETESTECKER	APPLIANCE COUPLER
2400.000		293031530107	2	MONTAGECLIP IC40510	MOUNTING CLIP IC40510
2410.000		293031530208		MONTAGECLIP IC40510	MOUNTING CLIP IC40510
2430.000		293031531208	9	MONTAGECLIP D53571/53572/60506/ 61516/61521	MOUNTING CLIP D53571/53572/60506/ 61516/61521
				D61524/IC50510/T50528/50529	D61524/IC50510/T50528/50529
2431.000		293031531802	9	MONTAGECLIP D53571/53572/60506/ 61516/61521	MOUNTING CLIP D53571/53572/60506/ 61516/61521
				D61524/IC50510/T50528/50529	D61524/IC50510/T50528/50529
2450.000		293031531605		MONTAGECLIP T52503	MOUNTING CLIP T52503
2455.000		293031561600	2	ISOLIERUNG D60019/60021	INSULATING D60019/60021
2456.000		293031561700	2	ISOLIERUNG D60019/60021	INSULATING D60019/60021
2465.000		293031561800		FOLIE WAERMELEITEND D60506	FOIL HEAT CONDUCTING D60506
2470.000		293031562000	6	FOLIE WAERMELEITEND D61516/ 61521/61524/IC50510/T50528/50529	FOIL HEAT CONDUCTING D61516/ 61521/61524/IC50510/T50528/50529
2480.000		293031562100	2	FOLIE WAERMELEITEND D53571/53572	FOIL HEAT CONDUCTING D53571/53572
2485.000		293031562300		FOLIE WAERMELEITEND T53501	FOIL HEAT CONDUCTING T53501
2490.000		293031562800	2	FOLIE WAERMELEITEND D60019/60021	FOIL HEAT CONDUCTING D60019/60021
2495.000		293031563301		FOLIE WAERMELEITEND T60506	FOIL HEAT CONDUCTING T60506
				X = SIEHE GESONDERTE E-LISTE WW. = WAHLWEISE	X = SEE SEPARATE PARTS LIST WW. = OPTIONAL

POS. NR. POS. NO.	MATERIAL-NR. PART NUMBER	BEZEICHNUNG DESCRIPTION	POS. NR. POS. NO.	MATERIAL-NR. PART NUMBER	BEZEICHNUNG DESCRIPTION
C 40502	845299615000	ELKO 2200UF 20% 25V	C 61521	865006704600	KERKO HV C 100PF 20% 1KV
C 50512	845299615000	ELKO 2200UF 20% 25V	C 61522	845209705500	ELKO #16 600/680UF +50-20% 63V
C 50526	845299865000	ELKO 2200UF 20% 25V	C 61524	865006704600	KERKO HV C 100PF 20% 1KV
C 53512	851591160200	FOKO FKP1 142PF 2,5% 2000V	C 61561	865006704600	KERKO HV C 100PF 20% 1KV
C 60506	865006704600	KERKO HV C 100PF 20% 1KV	C 61562	845209701500	ELKO #39 1000UF +50-20% 25V
C 60509	851591104000	FOKO FKP1 220PF 10% 1600V	C 61563	845209701500	ELKO #39 1000UF +50-20% 25V
C 60512	865008111100	KERKO HV C 270PF 20% 2KV	C 61566	865006704600	KERKO HV C 100PF 20% 1KV
C 60518	851591140300	FOKO FKP1 0,01UF 5% 1250V	C 62501 △	851179304700	FOKO MP3/KT 0,47UF20% 275V
C 60519	865006704600	KERKO HV C 100PF 20% 1KV	C 62502 △	851179304700	FOKO MP3/KT 0,47UF20% 275V
C 60521	865006704600	KERKO HV C 100PF 20% 1KV	C 62521 △	866009823400	KERKO SI 1000PF 20% 400V
C 60523	865008112500	KERKO HV C 1000PF 20% 1KV	C 62548 △	866009823800	KERKO SI 2200PF 20% 400V
C 60524	865008112500	KERKO HV C 1000PF 20% 1KV	C 62549 △	866009823400	KERKO SI 1000PF 20% 400V
C 60526	865008112500	KERKO HV C 1000PF 20% 1KV	CD 21636	833050414800	MELF DIODE MCL4148
C 60527	865008112500	KERKO HV C 1000PF 20% 1KV	CD 21666	833050414800	MELF DIODE MCL4148
C 60528 △	844330315000	ELKO SNT #3 150UF 20% 450V	CD 40536	833050414800	MELF DIODE MCL4148
C 60529 △	851179301800	FOKO MP3 0,1UF 20% 275V	CD 52503	833050414800	MELF DIODE MCL4148
C 60801	865006703100	KERKO HV C 47PF 20% 2KV	CD 53519	833050414800	MELF DIODE MCL4148
C 60802	865008112500	KERKO HV C 1000PF 20% 1KV	CD 55503	830945504400	MELF Z-DIODE 4,3B 0,5W
C 61511	865006704600	KERKO HV C 100PF 20% 1KV	CD 55504	833050414800	MELF DIODE MCL4148
C 61512	865006704600	KERKO HV C 100PF 20% 1KV	CD 57501	833050414800	MELF DIODE MCL4148
C 61514	851591103800	FOKO FKP1 100PF 10% 1600V			

ÄNDERUNGEN VORBEHALTEN / SUBJECT TO ALTERATION







POS. NR. POS. NO.	MATERIAL-NR. PART NUMBER	BEZEICHNUNG DESCRIPTION
CD 58521	833050414800	MELF DIODE MCL4148
CD 58522	833050414800	MELF DIODE MCL4148
CD 60811	833010130200	MELF DIODE BAV 302
CD 60812	832561034100	SMD DIODE STPS340U
CD 61528	832538430100	SMD Z-DIODE BZ84B30
CD 61538	832561034100	SMD DIODE STPS340U
CD 61548	832561034100	SMD DIODE STPS340U
CD 61558	832561034100	SMD DIODE STPS340U
CD 70501	830945505100	MELF-Z DIODE 5,1 C 0,5W
CD 85513	830945505200	MELF-Z DIODE 5,1 B 0,5W
CIC 21660	830598600000	SMD IC 74LV00
CL 60504	810498233100	SMD DAEMPF-PERLE 0805
CT 21635	830100685800	SMD TRANS BC858C/ BC857C
CT 21650	830100684800	SMD TRANS BC848C/ BC847C
CT 21658	830100684800	SMD TRANS BC848C/ BC847C
CT 21670	830100484800	SMD TRANS BC848B/ BC847B
CT 40531	830100484800	SMD TRANS BC848B/ BC847B
CT 40591	830100484800	SMD TRANS BC848B/ BC847B
CT 44515	830100484800	SMD TRANS BC848B/ BC847B
CT 57506	830100484800	SMD TRANS BC848B/ BC847B
CT 58512	830100484800	SMD TRANS BC848B/ BC847C
CT 60806	830100685800	SMD TRANS BC858C/ BC857C
CT 61585	830100484800	SMD TRANS BC848B/ BC847B
CT 85505	830100385800	SMD TRANS BC858B/ BC857B
CT 85510	830100385800	SMD TRANS BC858B/ BC857B
D 21512	830921502000	DIODE 1N4004
D 21621	830921504500	DIODE 1N4148
D 21622	830921504500	DIODE 1N4148
D 40532	830921504500	DIODE 1N4148
D 50513	830951627200	DIODE BYV27/200
D 52506	830921502000	DIODE 1N4004
D 53508	830920100500	DIODE BA157
D 53519	830970900300	Z DIODE ZY 51
D 53571	830920435900	DIODE BY359 1500
D 53572	830920423000	DIODE BY 229-600
D 54501	830920100500	DIODE BA157
D 54511	830920100500	DIODE BA157
D 55512	830972033300	Z DIODE 33 C 0,5W
D 60019	830919780700	DIODE STTA806D
D 60021	830919780700	DIODE STTA806D
D 60509	830921140600	DIODE SF4006
D 60512	830951675400	DIODE BYT53B
D 60523	830856038400	GLR.SKB380C1500
D 61503	830972009900	Z DIODE 10 B 0,5W
D 61511	830951603800	DIODE BYV38
D 61512	830951603800	DIODE BYV38
D 61516	830951679800	DIODE BYT 08 P-1000
D 61521	830919682000	DIODE STPR820D
D 61524	830919682000	DIODE STPR820D
D 61533	830920100500	DIODE BA157
D 61561	830951717200	DIODE BYW172D
D 61566	830951717200	DIODE BYW172D
IC 40510	830536729700	IC TDA7297
IC 50510	830512597900	IC STV9379A
IC 55510	830533814500	IC TDA8145
IC 58510	830520439300	IC LM393P
IC 60510	830533464700	IC TDA16846-2
IC 60801	830547026400	IC TNY264
IC 60817	830546543100	IC TS431IZ-AP
IC 61510	830520435700	IC LM358N
IC 61535	830520497800	IC L4978
IC 61545	830520497800	IC L4978
IC 61555	830520497800	IC L4978
L 53501	810498205600	FERRITPERLE HF70 BTL 3,5X6

POS. NR. POS. NO.	MATERIAL-NR. PART NUMBER	BEZEICHNUNG DESCRIPTION
L 53502	810498205600	FERRITPERLE HF70 BTL 3,5X6
L 53503	810498205600	FERRITPERLE HF70 BTL 3,5X6
L 53511	814050524900	DR A AX-GA 10UH 10%
L 53512	092401140400	DROSSEL 1,5 MH/COIL 1,5 MH
L 53521	292031229700	LINEARITAETSREGLER
L 53521	292031229500	WW. LINEARITAETSREGLER
L 53574	092468595500	LINEARITY CONTROL
L 55514	092458160100	BRUECKENSPULE M.KERN
L 60506	810498208100	BRIDGE COIL W. CORE
L 60507	810498208000	O/W AUSKOPPELSPULE
L 60518	810498208000	E/W DECOUPLING COIL
L 60518	810498208000	FERRITPERLE 0,676UH LI
L 60518	810498208000	FERRITPERLE 0,676UH
L 60518	810498208000	FERRITPERLE 0,676UH
L 60528	292017119700	FERRITE BEAD
L 60812	814052499200	SPEICHERDROSSEL EF25/11 1,8MH
L 61511	810498201400	STORAGE CHOK EF25/11 1.8MH
L 61514	810498201400	SIEB-DR 10UH 15%
L 61521	810498201400	FILTER CHOKE 10UH 15%
L 61524	810498201400	DAEMPF-PERLE 433003038102
L 61524	810498201400	DAEMPF-PERLE 433003038102
L 61524	810498201400	DAEMPF-PERLE 433003038102
L 61524	810498201400	DAMPING BEAD
L 61527	814052499200	SIEB-DR 10UH 15%
L 61538	814052499500	FILTER CHOKE 10UH 15%
L 61548	814052105900	SIEB-DR 330UH
L 61548	814052106800	FILTER CHOKE 330UH
L 61548	814052106800	SPEICHER-DR 59UH 2,5A
L 61549	814052499200	STORAGE CHOK 59UH 2.5A
L 61558	814052106700	WW. SPEICHER-DR 67UH EF16
L 61558	814052106800	STORAGE CHOK 67UH EF16
L 61558	814052105900	STORAGE CHOK 67UH EF16
L 61561	810498201400	WW. SPEICHER-DR 59UH 2,5A
L 61562	814050506500	STORAGE CHOK 59UH 2,5A
L 61566	810498201400	DAEMPF-PERLE 433003038102
L 61567	814050506500	DAMPING BEAD
L 62501	295008359700	DR A AX-GA 47UH 5%
L 62501	295008359700	DAEMPF-PERLE 433003038102
L 62501	295008359700	DAMPING BEAD
L 62501	295008359700	DR A AX-GA 47UH 5%
L 62501	295008359700	ENTSTOER-DR 2X22MH
L 62501	295008359700	INTERFERENCE CHOKE 2X22MH
OK 22505	830600024200	OPTOKOPPLER IL4216-X001
OK 22505	830600036200	WW. OPTOKOPPLER TLP3063
OK 60531	830600001200	OPTOKOPPLER CNY17F1
OK 60546	830600001200	OPTOKOPPLER CNY17F1
OK 60805	830600061500	OPTOKOPPLER SFH615A-2
R 21523	870532102000	MOW 0411 6,2 OHM 5%
R 22501	831120001600	PTC DUO T251-A80-A10
R 22504	870004912100	KSW 0411 100 KOHM 5%
R 22506	870022905700	KSW NB 0207 220 OHM 5%
R 40502	873229600900	DRW 6,5 2,2 OHM 10%
R 50507	876642460600	MSW 0207 1,6 OHM 1% ST
R 50508	876642460600	MSW 0207 1,6 OHM 1% ST
R 50526	870042900500	KSW NB 0207 1,5 OHM 5%
R 50529	876635705900	MSW 0414 270 OHM 5%
R 52501	870532901700	MOW 0411 4,7 OHM 5%
R 52503	873023923900	DRW SI ST7 3W 39 OHM 5%
R 52505	870536901600	MOW 0617 4,3 OHM 5% LI
R 52506	870536901600	MOW 0617 4,3 OHM 5% LI
R 53508	870042909700	KSW NB 0207 10 KOHM 5% ST

POS. NR. POS. NO.	MATERIAL-NR. PART NUMBER	BEZEICHNUNG DESCRIPTION
R 53511	870522702100	MOW 0411 6,8 OHM 5%
R 53516	873028002100	DRW SI S11 7W 6,8 OHM 5%
R 53521	870536906300	MOW 0617 390 OHM 5% LI
R 54501	873500303300	DRW 0,75W 0,33 OHM 10%
R 54511	873500303300	DRW 0,75W 0,33 OHM 10%
R 55512	870536926700	MOW 0617 560 OHM 10% LI
R 55514	870123081700	NKS 3 4,7 OHM 5%
R 58501	876519810400	MSW 0207 20 KOHM 1%
R 60502	870006935600	KSW 0617 3 MOHM 2%
R 60504	870006934100	KSW 0617 680 KOHM 2%
R 60508	873506730100	DRW 7 15 KOHM 10%
R 60512	870000743200	KSW 0207 20 OHM 5%
R 60801	876521212700	MSW 0411 180 KOHM 5%
R 60802	831140107400	VDR SIOV-S07K385GS3
R 60803	870042904500	KSW NB 0207 68 OHM 5%
R 60806	876504915300	MSW SI 0414 2,2 MOHM VDE
R 61508	879005005400	ESTR.SK10-A 22 KOHM LIN
R 61512	870042904900	KSW NB 0207 100 OHM 5% ST
R 61518	870522732100	MOW 0411 100 KOHM 10%
R 61527	870536930100	MOW 0617 15 KOHM 10% LI
R 61533	873506404900	DRW 4 100 OHM 5%
R 62501	876504914500	MSW SI 0414 1 MOHM 5% VDE
R 62502	831100501700	NTC 4,7 OHM 30%
R 62503	831140127500	VDR SIOV-S14K275E2S11M5
R 62549	876634915500	MSW SI 0414 2,7 MOHM 5% LI
SI 52501	831561202700	SI LOET T315MA 250V
SI 60501	831562000300	SI 5X20 T2A L 250V
SI 61521	831562022500	SI LOET T2A 250V
SI 61524	831562102700	SI LOET T2,5A 250V
SI 61538	831561820000	SI LOET T1A 250V
SI 61561	831562022500	SI LOET T2A 250V
SI 61566	831562022500	SI LOET T2A 250V
SI 62501	831562250300	SI 5X20 T3,15A H 250V
T 50528	830221054400	TRANS BD544B/ BD538
T 50529	830221054300	TRANS BD543B/ BD537
T 52503	830221068200	TRANS BD 679A
T 53501	830262533100	TRANS 2SC5331
T 60506	830263829800	TRANS 2SK2699
TC 22503	831001000800	TRIAC BTB08-600CW
TR 52501	092468679700	UEBERTRAGER
TR 53500	292016800300	TRANSFORMER
TR 53500	292016800300	TRAFO DIODEN-SPLIT
TR 60500	292015859701	DIODE SPLIT TRANSFORMER
TR 60500	292015859701	SPERRWANDLERTRAFO
TR 60500	292015859701	REVERSE CONVERTER
TR 60801	292016299701	TRANSFORMER
TR 60801	292016299701	SPERRWANDLERTRAFO
TR 60801	292016299701	REVERSE CONVERTER
TR 60801	292016299701	TRANSFORMER

Es gelten die Vorschriften und Sicherheitshinweise gemäß dem Service Manual "Sicherheit", Mat.-Nummer 720108000000, sowie zusätzlich die eventuell abweichenden, landesspezifischen Vorschriften!



The regulations and safety instructions shall be valid as provided by the "Safety" Service Manual, part number 720108000000, as well as the respective national deviations.

ÄNDERUNGEN VORBEHALTEN / SUBJECT TO ALTERATION

ÄNDERUNGEN VORBEHALTEN / SUBJECT TO ALTERATION



POS. NR. POS. NO.	MATERIAL-NR. PART NUMBER	BEZEICHNUNG DESCRIPTION
----------------------	-----------------------------	----------------------------

R 50526	△ 870042900500	KSW NB 0207 1,5 OHM 5%
R 50529	△ 876635705900	MSW 0414 270 OHM 5%
R 52501	△ 870532901700	MOW 0411 4,7 OHM 5%
R 52503	△ 873023923900	DRW SI ST7 3W 39 OHM 5%
R 52505	△ 870536901600	MOW 0617 4,3 OHM 5%
R 53508	△ 870042909700	KSW NB 0207 10 KOHM 5%
R 53511	△ 870522702100	MOW 0411 6,8 OHM 5%
R 53516	△ 873028002100	DRW SI S11 7W 6,8 OHM 5%
R 53521	△ 870536906300	MOW 0617 390 OHM 5%
R 54501	△ 873500303300	DRW 0,75W 0,33 OHM 10%
R 54511	△ 873500303300	DRW 0,75W 0,33 OHM 10%
R 55512	△ 870536926700	MOW 0617 560 OHM 10%
R 55514	△ 870123081700	NKS 3 4,7 OHM 5%
R 58501	△ 876519810400	MSW 0207 20 KOHM 1%
R 58524	△ 870001134500	KSW 0204 1 MOHM 5%
R 60502	△ 870006935600	KSW 0617 3 MOHM 2%
R 60504	△ 870006934100	KSW 0617 680 KOHM 2%
R 60508	△ 873506730100	DRW 7 15 KOHM 10%
R 60512	△ 870000743200	KSW 0207 20 OHM 5%
R 60801	△ 876521212700	MSW 0411 180 KOHM 5%
R 60802	△ 831140107400	VDR SIOV-S07K385GS3
R 60803	△ 870042904500	KSW NB 0207 68 OHM 5%
R 60806	△ 876504915300	MSW SI 0414 2,2 MOHM
R 61508	△ 879005005400	ESTR.SK10-A 22 KOHM LIN
R 61512	△ 870042904900	KSW NB 0207 100 OHM 5%
R 61518	△ 870522732100	MOW 0411 100 KOHM 10%
R 61527	△ 870536930100	MOW 0617 15 KOHM 10%
R 61533	△ 873506404900	DRW 4 100 OHM 5%
R 62501	△ 876504914500	MSW SI 0414 1 MOHM 5%
R 62502	△ 831100501700	NTC 4,7 OHM 30%
R 62503	△ 831140127500	VDR SIOV-S14K275E2S11M5
R 62549	△ 876634915500	MSW SI 0414 2,7 MOHM 5%

SI 52501	△ 831561202700	SI LOET T315MA 250V
SI 60501	△ 831562000300	SI 5X20 T2A L 250V
SI 61521	△ 831562022500	SI LOET T2A 250V
SI 61524	△ 831562102700	SI LOET T2,5A 250V
SI 61538	△ 831561820000	SI LOET T1A 250V
SI 61561	△ 831562022500	SI LOET T2A 250V
SI 61566	△ 831562022500	SI LOET T2A 250V
SI 62501	△ 831562250300	SI 5X20 T3,15A H 250V

T 50528	830221054400	TRANS BD544B
T 50529	830221054300	TRANS BD543B
T 52503	830221068200	TRANS BD679A
T 53501	830262533100	TRANS 2SC5331
T 60506	830263829800	TRANS 2SK2699

TC 22503	△ 8310011000800	TRIAC BTB08-600CW F17
----------	-----------------	-----------------------

TR 52501	△ 092468679700	UEBERTRAGER TRANSFORMER DRIVER
----------	----------------	-----------------------------------

TR 53500	△ 292016800300	TRAF0 DIODEN-SPLIT TRANSFORMER DIODE SPLIT
----------	----------------	---

TR 60500	△ 292015859701	SPERRWANDLERTRAFO B.O.TYPE CONVERTER
----------	----------------	---

TR 60801	△ 292016299701	SPERRWANDLERTRAFO STAND BY B.O.TYPE CONVERTER TRANSFORMER STAND BY
----------	----------------	--

POS. NR. POS. NO.	MATERIAL-NR. PART NUMBER	BEZEICHNUNG DESCRIPTION
----------------------	-----------------------------	----------------------------

Ersatzteilliste  
Spare Parts List

7 / 2002

CHASSIS-FS-STEREO DIGI 100 CUC 1838  
CHASSIS TV STEREO DIGI 100 CUC 1838

MATERIAL-NR. / PART NO.: 297040194400

POS. NR. POS. NO.	ABB. FIG.	MATERIAL-NR. PART NUMBER	ANZ. QTY.	BEZEICHNUNG ①	DESCRIPTION ②
		297040194400		CHASSIS-FS-STEREO DIGI 100 CUC 1838 KEIN E-TEIL	CHASSIS TV STEREO DIGI 100 CUC 1838 NO SPARE PART
0200.000		295042622400	X	BAUSTEIN SIGNAL/ZF+TUNER	MODULE SIGNAL/IF+TUNER
0400.000		295042034200	X	BAUSTEIN FEATURE	MODULE FEATURE
0450.000		297006521102		HALTER BAUSTEIN	HOLDER MODULE
1000.000		096211130206	4	SICHERUNGSHALTER SI60501/62501	FUSE HOLDER SI60501/62501
2200.000	△	293033994802		NETZ EINBAUGERAETESTECKER	APPLIANCE COUPLER
2400.000		293031530107	2	MONTAGECLIP T53501/60506	MOUNTING CLIP T53501/60506
2410.000		293031530208		MONTAGECLIP IC40510	MOUNTING CLIP IC 40510
2430.000		293031531208	8	MONTAGECLIP D53571/53572/61516/ 61521/61524/IC50510/T50528/50529	MOUNTING CLIP D53571/53572/61516/ 61521/61524/IC50510/T50528/50529
2430.000		293031531802	WW. 8	MONTAGECLIP D53571/53572/61516/ 61521/61524/IC 50510/T50528/50529	MOUNTING CLIP D53571/53572/61516/ 61521/61524/IC50510/T50528/50529
2450.000		293031531605		MONTAGECLIP T52503	MOUNTING CLIP T52503
2455.000		293031561600	2	ISOLIERUNG D60019/60021	INSULATING D60019/60021
2455.000		293031561700	WW. 2	ISOLIERUNG D60019/60021	INSULATING D60019/60021
2470.000		293031562000	6	FOLIE WAERMELEITEND D61516/61521/ 61524/IC50510/T50528/50529	FOIL HEAT CONDUCTING D61516/61521/ 61524/IC50510/T50528/50529
2480.000		293031562100	2	FOLIE WAERMELEITEND D53571/53572	FOIL HEAT CONDUCTING D53571/53572
2485.000		293031562300		FOLIE WAERMELEITEND T53501	FOIL HEAT CONDUCTING T53501
2490.000		293031562800	2	FOLIE WAERMELEITEND D60019/60021	FOIL HEAT CONDUCTING D60019/60021
2495.000		293031563301		FOLIE WAERMELEITEND T60506	FOIL HEAT CONDUCTING T60506
				X = SIEHE GESONDERTE E-LISTE WW. = WAHLWEISE	X = SEE SEPARATE PARTS LIST WW. = OPTIONAL

POS. NR. POS. NO.	MATERIAL-NR. PART NUMBER	BEZEICHNUNG DESCRIPTION	POS. NR. POS. NO.	MATERIAL-NR. PART NUMBER	BEZEICHNUNG DESCRIPTION
C 50512	845299615000	ELKO 2200UF 20% 25V	C 61524	865006704600	KERKO HV C 100PF 20% 1KV
C 50526	845299865000	ELKO 2200UF 20% 25V	C 61561	865006704600	KERKO HV C 100PF 20% 1KV
C 53512	851591160200	FOKO FKP1 142PF 2,5% 2000V	C 61562	845209701500	ELKO #39 1000UF +50-20% 25V
C 53571	851591471900	FOKO FKP1 0,012UF 3,5% 2000V	C 61563	845209701500	ELKO #39 1000UF +50-20% 25V
C 60506	865006704600	KERKO HV C 100PF 20% 1KV	C 61566	865006704600	KERKO HV C 100PF 20% 1KV
C 60509	851591104000	FOKO FKP1 220PF 10% 1600V	C 62501	△ 851179304700	FOKO MP3/KT 0,47UF20% 275V
C 60512	865008111100	KERKO HV C 270PF 20% 2KV	C 62502	△ 851179304700	FOKO MP3/KT 0,47UF20% 275V
C 60518	851591140300	FOKO FKP1 0,01UF 5% 1250V	C 62521	△ 866009823400	KERKO SI 1000PF 20% 400V
C 60519	865006704600	KERKO HV C 100PF 20% 1KV	C 62548	△ 866009823800	KERKO SI 2200PF 20% 400V
C 60521	865006704600	KERKO HV C 100PF 20% 1KV	C 62549	△ 866009823400	KERKO SI 1000PF 20% 400V
C 60523	865008112500	KERKO HV C 1000PF 20% 1KV			
C 60524	865008112500	KERKO HV C 1000PF 20% 1KV	CD 21636	833050414800	MELF DIODE MCL4148
C 60526	865008112500	KERKO HV C 1000PF 20% 1KV	CD 21666	833050414800	MELF DIODE MCL4148
C 60527	865008112500	KERKO HV C 1000PF 20% 1KV	CD 40536	833050414800	MELF DIODE MCL4148
C 60528	△ 844330315000	ELKO SNT #3 150UF 20% 450V	CD 52503	833050414800	MELF DIODE MCL4148
C 60529	△ 851179301800	FOKO MP3 0,1UF 20% 275V	CD 53519	833050414800	MELF DIODE MCL4148
C 60801	865006703100	KERKO HV C 47PF 20% 2KV	CD 55503	830945504400	MELF Z-DIODE 4,3B 0,5W
C 60802	865008112500	KERKO HV C 1000PF 20% 1KV	CD 55504	833050414800	MELF DIODE MCL4148
C 61511	865006704600	KERKO HV C 100PF 20% 1KV	CD 57501	833050414800	MELF DIODE MCL4148
C 61512	865006704600	KERKO HV C 100PF 20% 1KV	CD 57503	833050414800	MELF DIODE MCL4148
C 61514	851591103800	FOKO FKP1 100PF 10% 1600V	CD 57504	833050414800	MELF DIODE MCL4148
C 61521	865006704600	KERKO HV C 100PF 20% 1KV	CD 57506	830945515000	MELF Z-DIODE 15VB 0,5W
C 61522	845209705500	ELKO #16 600/680UF +50-20% 63V	CD 58501	833050414800	MELF DIODE MCL4148

Es gelten die Vorschriften und Sicherheitshinweise gemäß dem Service Manual "Sicherheit", Mat.-Nummer 720108000000, sowie zusätzlich die eventuell abweichenden, landesspezifischen Vorschriften!



The regulations and safety instructions shall be valid as provided by the "Safety" Service Manual, part number 720108000000, as well as the respective national deviations.

ÄNDERUNGEN VORBEHALTEN / SUBJECT TO ALTERATION

ÄNDERUNGEN VORBEHALTEN / SUBJECT TO ALTERATION

POS. NR. POS. NO.	MATERIAL-NR. PART NUMBER	BEZEICHNUNG DESCRIPTION
CD 58504	833050414800	MELF DIODE MCL4148
CD 58507	830945502800	MELF Z-DIODE 2,7B 0,5W
CD 58511	833050414800	MELF DIODE MCL4148
CD 58512	833050414800	MELF DIODE MCL4148
CD 58521	833050414800	MELF DIODE MCL4148
CD 58522	833050414800	MELF DIODE MCL4148
CD 60811	833010130200	MELF DIODE BAV 302
CD 60812	832561034100	SMD DIODE STPS340U
CD 61528	832538430100	SMD Z-DIODE BZX84B30
CD 61538	832561034100	SMD DIODE STPS340U
CD 61548	832561034100	SMD DIODE STPS340U
CD 61558	832561034100	SMD DIODE STPS340U
CD 70501	830945505100	MELF-Z DIODE 5,1C 0,5W
CD 85513	830945505200	MELF-Z DIODE 5,1B 0,5W
CIC 21660	830598600000	SMD IC 74LV00
CL 60504	810498233100	SMD DAEMPF-PERLE
CT 21635	830100685800	SMD TRANS BC858C/BC857C
CT 21650	830100684800	SMD TRANS BC848C/BC847C
CT 21658	830100684800	SMD TRANS BC848C/BC847C
CT 21670	830100484800	SMD TRANS BC848B/BC847B
CT 40531	830100484800	SMD TRANS BC848B/BC847B
CT 40591	830100484800	SMD TRANS BC848B/BC847B
CT 44515	830100484800	SMD TRANS BC848B/BC847B
CT 57506	830100484800	SMD TRANS BC848B/BC847B
CT 58512	830100484800	SMD TRANS BC848B/BC847B
CT 60806	830100685800	SMD TRANS BC858C/BC857C
CT 61585	830100484800	SMD TRANS BC848B/BC847B
CT 85505	830100385800	SMD TRANS BC858B/BC857B
CT 85510	830100385800	SMD TRANS BC858B/BC857B
D 21512	830921502000	DIODE 1N4004
D 21621	830921504500	DIODE 1N4148
D 21622	830921504500	DIODE 1N4148
D 40532	830921504500	DIODE 1N4148
D 50513	830951627200	DIODE BYV27/200
D 52506	830921502000	DIODE 1N4004
D 53508	830920100500	DIODE BA157
D 53519	830970900300	Z DIODE ZY51
D 53571	830920435900	DIODE BY359 1500
D 53572	830920423000	DIODE BY229-600
D 54501	830920100500	DIODE BA157
D 54511	830920100500	DIODE BA157
D 55512	830972033300	Z DIODE 33C 0,5W
D 60019	830919780600	DIODE STTA806DI
D 60019	830919780700	WW-DIODE STTA806D
D 60021	830919780600	DIODE STTA806DI
D 60021	830919780700	WW-DIODE STTA806D
D 60509	830921140600	DIODE SF4006
D 60512	830951675400	DIODE BYT53B
D 60523	830856038400	GLR.SKB380C1500
D 61503	830972009900	Z DIODE 10B 0,5W
D 61511	830951603800	DIODE BYV38
D 61512	830951603800	DIODE BYV38
D 61516	830951679800	DIODE BYT08 P-1000
D 61521	830919682000	DIODE STPR820D
D 61524	830919682000	DIODE STPR820D
D 61533	830920100500	DIODE BA157
D 61561	830951717200	DIODE BYW172D
D 61566	830951717200	DIODE BYW172D
IC 40510	830536729700	IC TDA7297
IC 50510	830512597900	IC STV9379A
IC 55510	830533814500	IC TDA8145
IC 58510	830520439300	IC LM393P
IC 60510	830533464700	IC TDA16846-2
IC 60801	830547026400	IC TNY264
IC 60817	830546543100	IC TS431IZ-AP

POS. NR. POS. NO.	MATERIAL-NR. PART NUMBER	BEZEICHNUNG DESCRIPTION
IC 61510	830520435700	IC LM358N
IC 61535	830520497800	IC L4978
IC 61545	830520497800	IC L4978
IC 61555	830520497800	IC L4978
L 53501	810498205600	FERRITPERLE HF70 BTL 3,5X
L 53502	810498205600	FERRITPERLE HF70 BTL 3,5X
L 53503	810498205600	FERRITPERLE HF70 BTL 3,5X
L 53511	814050524900	DR A AX-GA 10UH 10%
L 53512	092401140400	DROSSEL 1,5 MH
L 53511	814050524900	DR A AX-GA 10UH 10%
L 53512	092401140400	DROSSEL 1,5 MH
L 53521	292031229700	LINEARITAETSREGLER
L 53521	292031229500	WW.LINEARITAETSREGLER
L 53574	092468595500	BRUECKENSPULE M.KERN
L 55514	092458160100	O/W AUSKOPPELSPULE
L 60506	810498208100	FERRITPERLE 0,676UH
L 60507	810498208000	FERRITPERLE 0,676UH
L 60518	810498208000	FERRITPERLE 0,676UH
L 60528	292017119700	FERRITE BEAD
L 60528	292017119700	SPEICHERDROSSEL
L 60812	814052499200	STORAGE CHOKE
L 60812	814052499200	SIEB-DR 10UH 15%
L 61511	810498201400	DAEMPF-PERLE 433003038102
L 61514	810498201400	DAEMPF-PERLE 433003038102
L 61521	810498201400	DAEMPF-PERLE 433003038102
L 61524	810498201400	DAEMPF-PERLE 433003038102
L 61527	814052499200	DAMPING BEAD
L 61538	814052499500	SIEB-DR 10UH 15%
L 61538	814052499500	SIEB-DR 330UH
L 61548	814052105900	FILTER CHOKE
L 61548	814052106800	SPEICHER-DR 59UH 2,5A
L 61548	814052106800	SPEICHER-DR 67UH
L 61549	814052499200	STORAGE CHOKE
L 61549	814052499200	SIEB-DR 10UH 15%
L 61558	814052105900	FILTER CHOKE
L 61558	814052105900	SPEICHER-DR 59UH 2,5A
L 61558	814052106700	DIODE-DR EF16 67UH
L 61558	814052106800	SPEICHER-DR 67UH
L 61561	810498201400	DAEMPF-PERLE 433003038102
L 61562	814050506500	STORAGE CHOKE
L 61562	814050506500	DR A AX-GA 47UH 5%
L 61566	810498201400	DAEMPF-PERLE 433003038102
L 61566	810498201400	CHOKER
L 61567	814050506500	DAMPING BEAD
L 61567	814050506500	DR A AX-GA 47UH 5%
L 62501	295008359700	CHOKER
L 62501	295008359700	ENTSTOER-DR 2X22MH
L 62501	295008359700	INTERFERENCE CHOKE
OK 22505	830600036200	OPTOKOPPLER
OK 22505	830600024200	WW.OPTOKOPPLER
OK 60531	830600001200	OPTOKOPPLER
OK 60546	830600001200	OPTOKOPPLER
OK 60805	830600061500	OPTOKOPPLER
OK 60805	830600061500	OPTO COUPLER
R 21512	870000754900	KSW 0207 1,5 MOHM 5%
R 21523	870532102000	MOW 0411 6,2 OHM 5%
R 22501	831120001600	PTC DUO T251-A80-A10
R 22504	870004912100	KSW 0411 100 KOHM 5%
R 22504	870022905700	KSW NB 0207 220 OHM 5%
R 22506	870022905700	KSW NB 0207 220 OHM 5%
R 40502	873229600900	DRW 6,5 2,2 OHM 10%
R 50507	876642460600	MSW 0207 1,6 OHM 1%
R 50508	876642460600	MSW 0207 1,6 OHM 1%

POS. NR. POS. NO.	MATERIAL-NR. PART NUMBER	BEZEICHNUNG DESCRIPTION
R 50526	870042900500	KSW NB 0207 1,5 OHM 5%
R 50529	876635705900	MSW 0414 270 OHM 5%
R 52501	870532901700	MOW 0411 4,7 OHM 5%
R 52503	873023923900	DRW SI ST7 3W 39 OHM 5%
R 52505	870536901600	MOW 0617 4,3 OHM 5%
R 52506	870536901600	MOW 0617 4,3 OHM 5%
R 53508	870042909700	KSW NB 0207 10 KOHM 5%
R 53511	870522702100	MOW 0411 6,8 OHM 5%
R 53516	873028002100	DRW SI S11 7W 6,8 OHM 5%
R 53521	870536906300	MOW 0617 390 OHM 5%
R 54501	873500303300	DRW 0,75W 0,33 OHM 10%
R 54511	873500303300	DRW 0,75W 0,33 OHM 10%
R 55512	870536926700	MOW 0617 560 OHM 10%
R 55514	870123081700	NKS 3 4,7 OHM 5%
R 58501	876519810400	MSW 0207 20 KOHM 1%
R 58524	870001134500	KSW 0204 1 MOHM 5%
R 60502	8700069835600	KSW 0617 3 MOHM 2%
R 60504	870006934100	KSW 0617 680 KOHM 2%
R 60508	873506730100	DRW 7 15 KOHM 10%
R 60512	870000743200	KSW 0207 20 OHM 5%
R 60801	876521212700	MSW 0411 180 KOHM 5%
R 60802	831140107400	VDR SIOV-S07K385GS3
R 60803	870042904500	KSW NB 0207 68 OHM 5%
R 60804	870000740100	KSW 0207 1 OHM 5%
R 60806	876504915300	MSW SI 0414 2,2 MOHM
R 61508	879005005400	ESTR.SK10-A 22 KOHM LIN
R 61512	870042904900	KSW NB 0207 100 OHM 5%
R 61518	870522732100	MOW 0411 100 KOHM 10%
R 61527	870536930100	MOW 0617 15 KOHM 10%
R 61533	873506404900	DRW 4 100 OHM 5%
R 62501	876504914500	MSW SI 0414 1 MOHM 5%
R 62502	831100501700	NTC 4,7 OHM 30%
R 62503	831140127500	VDR SIOV-S14K275E2S1M5
R 62549	876634915500	MSW SI 0414 2,7 MOHM 5%
SI 52501	831561202700	SI LOET T315MA 250V
SI 60501	831562000300	SI 5X20 T2A L 250V
SI 61521	831562022500	SI LOET T2A 250V
SI 61524	831562102700	SI LOET T2,5A 250V
SI 61538	831561820000	SI LOET T1A 250V
SI 61561	831562022500	SI LOET T2A 250V
SI 61566	831562022500	SI LOET T2A 250V
SI 62501	831562250300	SI 5X20 T3,15A H 250V
T 50528	830221054400	TRANS BD544B
T 50529	830221054300	TRANS BD543B
T 52503	830221068200	TRANS BD679A
T 53501	830262533100	TRANS 2SC5331
T 60506	830263829800	TRANS 2SK2699
TC 22503	831001000800	TRIAC BTB08-600CW F17
TR 52501	092468679700	UEBERTRAGER
TR 53500	292016800300	TRANSFORMER DRIVER
TR 53500	292016800300	TRAFO DIODEN-SPLIT
TR 60500	292015859701	TRANSFORMER DIODE SPLIT
TR 60500	292015859701	SPERRWANDLERTRAFO
TR 60500	292015859701	B.O.TYPE CONVERTER
TR 60801	292016299701	TRANSFORMER
TR 60801	292016299701	SPERRWANDLERTRAFO STAND BY
TR 60801	292016299701	B.O.TYPE CONVERTER
TR 60801	292016299701	TRANSFORMER STAND BY

Es gelten die Vorschriften und Sicherheitshinweise gemäß dem Service Manual "Sicherheit", Mat.-Nummer 720108000000, sowie zusätzlich die eventuell abweichenden, landesspezifischen Vorschriften!



The regulations and safety instructions shall be valid as provided by the "Safety" Service Manual, part number 720108000000, as well as the respective national deviations.

ÄNDERUNGEN VORBEHALTEN / SUBJECT TO ALTERATION

ÄNDERUNGEN VORBEHALTEN / SUBJECT TO ALTERATION

Ersatzteilliste  
Spare Parts List

8 / 2002

CHASSIS-FS-STEREO CUC 1838 DIGI 100  
CHASSIS TV STEREO CUC 1838 DIGI 100

MATERIAL-NR. / PART NO.: 297040196000

Table with columns: POS. NR. ABB. MATERIAL-NR. ANZ. BEZEICHNUNG, POS. NO. FIG. PART NUMBER QTY. (D), DESCRIPTION (GB). Includes parts like BAUSTEIN SIGNAL, DYN.FOKUSSIERUNGSPLETTE, and NETZ EINBAUGERAETESTECKER.

Table with columns: POS. NR. MATERIAL-NR. BEZEICHNUNG, POS. NR. MATERIAL-NR. BEZEICHNUNG, POS. NO. PART NUMBER DESCRIPTION. Includes parts like ELKO 2200UF 20% 25V, KERKO HV C 100PF 20% 1KV, and FOKO FKP1 142PF 2.5% 2000V.

ÄNDERUNGEN VORBEHALTEN / SUBJECT TO ALTERATION

Table with columns: POS. NR. MATERIAL-NR. BEZEICHNUNG, POS. NO. PART NUMBER DESCRIPTION. Includes parts like MELF DIODE MCL4148, SMD TRANS BC848B/ BC847B, and DIODE IN4004.

Table with columns: POS. NR. MATERIAL-NR. BEZEICHNUNG, POS. NO. PART NUMBER DESCRIPTION. Includes parts like DIODE BAV21, IC TDA7297, FERRITPERLE HF70 BTL 3.5X6, and SPEICHERDROSSEL EF25/11 1.8MH.

ÄNDERUNGEN VORBEHALTEN / SUBJECT TO ALTERATION

POS. NR. POS. NO.	MATERIAL-NR. PART NUMBER	BEZEICHNUNG DESCRIPTION
----------------------	-----------------------------	----------------------------

OK 60531	830600001200	OPTOKOPPLER CNY17F1
OK 60546	830600001200	OPTOKOPPLER CNY17F1
OK 60805	830600061500	OPTOKOPPLER SFH615A-2

R 21523	870532901700	MOW 0411 4,7 OHM 5%
R 22501	831120001800	PTC DUO B59709-T60-A110
R 22504	870004912100	KSW 0411 100 KOHM 5%
R 22506	870022905700	KSW NB 0207 220 OHM 5%
R 40502	873229600900	DRW 6,5 2,2 OHM 10%
R 50507	876642460500	MSW 0207 1,5 OHM 1%
R 50508	876642460500	MSW 0207 1,5 OHM 1%
R 50526	870042900500	KSW NB 0207 1,5 OHM 5%
R 50531	870536905500	MOW 0617 180 OHM 5% LI
R 52501	870532901700	MOW 0411 4,7 OHM 5%
R 52503	873023923900	DRW SI ST7 3W 39 OHM 5%
R 52505	870536901600	MOW 0617 4,3 OHM 5% LI
R 52506	870536901600	MOW 0617 4,3 OHM 5% LI
R 53508	870042909700	KSW NB 0207 10 KOHM 5% ST
R 53511	870522702100	MOW 0411 6,8 OHM 5%
R 53516	873028002100	DRW SI S11 7W 6,8 OHM 5%
R 53521	870536906300	MOW 0617 390 OHM 5% LI
R 54501	873500303300	DRW 0,75W 0,33 OHM 10%
R 54511	873500303300	DRW 0,75W 0,33 OHM 10%
R 55512	870536906500	MOW 0617 470 OHM 5% LI
R 55514	870123081700	NKS 3 4,7 OHM 5%
R 58501	876519810400	MSW 0207 20 KOHM 1%
R 58502	876519808600	MSW 0207 3,6 KOHM 1%
R 60502	870006935600	KSW 0617 3 MOHM 2%
R 60504	870006934100	KSW 0617 680 KOHM 2%
R 60508	873506730100	DRW 7 15 KOHM 10%
R 60512	870000743200	KSW 0207 20 OHM 5%
R 60801	876521212700	MSW 0411 180 KOHM 5%
R 60802	831140107400	VDR SIOV-S07K385GS3
R 60803	870042904500	KSW NB 0207 68 OHM 5%
R 60806	876504915300	MSW SI 0414 2,2 MOHM VDE
R 61508	879005005400	ESTR.SK10-A 22 KOHM LIN
R 61512	870042904900	KSW NB 0207 100 OHM 5% ST
R 61518	870522732100	MOW 0411 100 KOHM 10%
R 61527	870536930100	MOW 0617 15 KOHM 10% LI
R 61533	873506404900	DRW 4 100 OHM 5%
R 62501	876504914500	MSW SI 0414 1 MOHM 5% VDE
R 62502	831100501700	NTC 4,7 OHM 30%
R 62503	831140127500	VDR SIOV-S14K275E2S11M5
R 62549	876634915500	MSW SI 0414 2,7 MOHM 5% LI
R 64003	870240109700	KMW 0411 10 KOHM 10%
R 64006	293035521200	FOKUS-FUSSPUNKTREGLER

SI 52501	831561202700	SI LOET T315MA 250V
SI 60501	831562000300	SI 5X20 T2A L 250V
SI 61521	831562022500	SI LOET T2A 250V
SI 61524	831562102700	SI LOET T2,5A 250V
SI 61538	831561820000	SI LOET T1A 250V
SI 61561	831562022500	SI LOET T2A 250V
SI 61566	831562022500	SI LOET T2A 250V
SI 62501	831562250300	SI 5X20 T3,15A H 250V

T 21511	830340129900	TRANS.BF299 G/PBF259
T 50528	830221054400	TRANS BD544B/ BD538
T 50529	830221054300	TRANS BD543B/ BD537
T 52503	830221068200	TRANS.BD 679A
T 53501	830262533100	TRANS 2SC5331
T 60506	830263829800	TRANS 2SK2699
T 64016	830328763900	TRANS.BC 639
T 64110	830320554800	TRANS BC548B/ BC547B

TC 22503	831001000800	TRIAC BTB08-600CW
----------	--------------	-------------------

Es gelten die Vorschriften und Sicherheitshinweise gemäß dem Service Manual "Sicherheit", Mat.-Nummer 720108000000, sowie zusätzlich die eventuell abweichenden, landesspezifischen Vorschriften!



The regulations and safety instructions shall be valid as provided by the "Safety" Service Manual, part number 720108000000, as well as the respective national deviations.

ÄNDERUNGEN VORBEHALTEN / SUBJECT TO ALTERATION

POS. NR. POS. NO.	MATERIAL-NR. PART NUMBER	BEZEICHNUNG DESCRIPTION
----------------------	-----------------------------	----------------------------

TR 52501	092468679700	UEBERTRAGER TRANSFORMER
TR 53500	292016800701	DIODEN-SPLIT TRAF0 DIODE SPLIT TRANSFORMER
TR 60500	292015849702	SPERRWANDLERTRAF0 REVERSE CONVERTER TRANSFORMER
TR 60801	292016299701	SPERRWANDLERTRAF0 REVERSE CONVERTER TRANSFORMER
TR 64001	292014499700	FOKUSSIERUNGSUEBERTRAGER FOCUSING TRANSFORMER

## Ersatzteilliste Spare Parts List

7 / 2002

## CHASSIS-FS-STEREO CUC 1838 DIGI 100 CHASSIS TV STEREO CUC 1838 DIGI 100

MATERIAL-NR. / PART NO.: 297040197200

POS. NR. POS. NO.	ABB. FIG.	MATERIAL-NR. PART NUMBER	ANZ. QTY.	BEZEICHNUNG ①	DESCRIPTION ②
		297040197200		CHASSIS-FS-STEREO CUC 1838 DIGI 100 KEIN E-TEIL	CHASSIS TV STEREO CUC 1838 DIGI 100 NO SPARE PART
0100.000		295042622400	X	BAUSTEIN SIGNAL / ZF+TUNER	MODULE SIGNAL / IF TUNER
0216.000		297033571100		TASTSCHALTER PROGRAMM+	KEY SWITCH PROGRAMME+
0216.000		297033571100		TASTSCHALTER PROGRAMM-	KEY SWITCH PROGRAMME-
0216.000		297033571100		TASTSCHALTER LAUTSTAERKE+	KEY SWITCH VOLUME+
0216.000		297033571100		TASTSCHALTER LAUTSTAERKE-	KEY SWITCH VOLUME-
0240.000		293033904200		KOPFH0ERERBUCHSE 3,5 O.SCHALTER	HEADPHONE SOCKET 3,5 W/O SWITCH
0241.000		293031689401		CINCH-BUCHSE 3-FACH FBAS/NF L,R	CINCH SOCKET 3 FOLD FBAS/AF L,R
0400.000		295042032100	X	BAUSTEIN FEATURE	MODULE FEATURE
0451.000		297006521102		HALTER BAUSTEIN	HOLDER MODULE
1000.000		096211130206	4	SICHERUNGSHALTER SI60501/62501	FUSE HOLDER SI60501/62501
1070.000		293050254300		DYN.FOKUSSIERUNGSPLETTE	DYN.FOCUSING BOARD
1071.000	△	292013610400		FOKUS U.UG2-REGLER	FOCUS AND UG2-CONTROLLER
1072.000		292107030200		FOKUSLEITUNG	FOCUS CABLE
1073.000		297006400100		KLAMMER FOKUS-FUSSPUNKTREGLER	CLAMP FOCUS FOOT CONTROL
1074.000		293032300200		FUNKENSTRECKE 1,6KV	SPARK GAP 1.6KV
1075.000		297006540102		HALTER FOKUSPLATTE	HOLDER FOCUS BOARD
2000.000	△	297033910100		NETZSCHALTER O.WISCHER	POWER SWITCH W/O WIPER
2200.000	△	293033994802		NETZ EINBAUGERAETESTECKER	APPLIANCE COUPLER W.CABLE
2400.000		293031530107	2	MONTAGECLIP T53501/60506	MOUNTING CLIP T53501/60506
2410.000		293031530208		MONTAGECLIP IC40510	MOUNTING CLIP IC40510
2420.000		293031531208	8	MONTAGECLIP D53571/53572/ D61516/61521/61524/IC50510/ T50528/50529	MOUNTING CLIP D53571/53572/ D61516/61521/61524/IC50510/ T50528/50529
2430.000		293031531605		MONTAGECLIP T52503	MOUNTING CLIP T52503
2440.000		293031561600		ISOLIERUNG D60019	INSULATION D60019
2445.000		293031561700		ISOLIERUNG D60021	INSULATION D60021
2450.000		293031562000	6	FOLIE WAERMELEITEND D61516/61521/ D61524/IC50510/T50528/50529	FOIL HEAT CONDUCTING D61516/61521/ D61524/IC50510/T50528/50529
2460.000		293031562100		FOLIE WAERMELEITEND D53572	FOIL HEAT CONDUCTING D53572
2470.000		293031562300		FOLIE WAERMELEITEND D53571	FOIL HEAT CONDUCTING D53571
2480.000		293031562800	2	FOLIE WAERMELEITEND D60019/60021	FOIL HEAT CONDUCTING D60019/60021
2490.000		293031563301		FOLIE WAERMELEITEND T60506	FOIL HEAT CONDUCTING T60506
				WW =WAHLWEISE X=SIEHE GESONDERTE E-LISTE	WW =OPTIONAL X=SEE SEPARATE PARTS LIST

POS. NR. POS. NO.	MATERIAL-NR. PART NUMBER	BEZEICHNUNG DESCRIPTION
----------------------	-----------------------------	----------------------------

C 40502	845299615000	ELKO 2200UF 20% 25V
C 50512	845299614700	ELKO 1000UF 20% 25V
C 50526	845299614700	ELKO 1000UF 20% 25V
C 53512	851591160200	FOKO FKP1 142PF 2,5% 2000V
C 53571	851591471900	FOKO FKP1 0,012UF 3,5% 2000V
C 60506	865006704600	KERKO HV C 100PF 20% 1KV
C 60509	851591104000	FOKO FKP1 220PF 10% 1600V
C 60512	865008111100	KERKO HV C 270PF 20% 2KV
C 60518	851591140300	FOKO FKP1 0,01UF 5% 1250V
C 60519	865006704600	KERKO HV C 100PF 20% 1KV
C 60521	865006704600	KERKO HV C 100PF 20% 1KV

POS. NR. POS. NO.	MATERIAL-NR. PART NUMBER	BEZEICHNUNG DESCRIPTION
----------------------	-----------------------------	----------------------------

C 60523	865008112500	KERKO HV C 1000PF 20% 1KV
C 60524	865008112500	KERKO HV C 1000PF 20% 1KV
C 60526	865008112500	KERKO HV C 1000PF 20% 1KV
C 60527	865008112500	KERKO HV C 1000PF 20% 1KV
C 60528	844330315000	ELKO SNT #3 150UF 20% 450V
C 60529	851179301800	FOKO MP3 0,1UF 20% 275VW
C 60801	865006703100	KERKO HV C 47PF 20% 2KV
C 60802	865008112500	KERKO HV C 1000PF 20% 1KV
C 61511	865006704600	KERKO HV C 100PF 20% 1KV
C 61512	865006704600	KERKO HV C 100PF 20% 1KV
C 61514	851591103800	FOKO FKP1 100PF 10% 1600V

ÄNDERUNGEN VORBEHALTEN / SUBJECT TO ALTERATION











Ersatzteilliste  
Spare Parts List

7 / 2002

CHASSIS-FS-STEREO DIGI 100 CUC 1838  
CHASSIS TV STEREO DIGI 100 CUC 1838

MATERIAL-NR. / PART NO.: 297040197800

POS. NR. POS. NO.	MATERIAL-NR. PART NUMBER	BEZEICHNUNG DESCRIPTION
L 61521	810498201400	DAEMPF-PERLE 433003038102
L 61524	810498201400	DAEMPF-PERLE 433003038102
		DAMPING BEAD
L 61527	814052499200	SIEB-DR 10UH 15%
L 61538	814052499500	SIEB-DR 330UH
		FILTER CHOKE
L 61548	814052106800	SPEICHER-DR 67UH
L 61548	814052105900	SPEICHER-DR 59UH 2,5A
		STORAGE CHOKE
L 61549	814052499200	SIEB-DR 10UH 15%
		FILTER CHOKE
L 61558	814052106700	SPEICHER-DR EF16 67UH
L 61558	814052106800	SPEICHER-DR 67UH
L 61558	814052105900	SPEICHER-DR 59UH 2,5A
		STORAGE CHOKE
L 61561	810498201400	DAEMPF-PERLE 433003038102
		DAMPING BEAD
L 61562	814050506500	DR A AX-GA 47UH 5%
		CHOKE
L 61566	810498201400	DAEMPF-PERLE 433003038102
		DAMPING BEAD
L 61567	814050506500	DR A AX-GA 47UH 5%
		CHOKE
L 62501	295008359700	ENTSTOER-DR 2X22MH
		INTERFERENCE CHOKE
OK 22505	830600036200	OPTOKOPLER
OK 22505	830600024200	WW. OPTOKOPLER
OK 60531	830600001200	OPTOKOPLER
OK 60546	830600001200	OPTOKOPLER
OK 60805	830600061500	OPTOKOPLER
		OPTO COUPLER
R 21512	870000754900	KSW 0207 1,5 MOHM 5%
R 21523	870532901700	MOW 0411 4,7 OHM 5%
R 22501	831120001800	PTC DUO B59709-T60-A110
R 22506	870022905700	KSW NB 0207 220 OHM 5%
R 40502	873229600900	DRW 6,5 2,2 OHM 10%
R 50507	876642460500	MSW 0207 1,5 OHM 1%
R 50508	876642460500	MSW 0207 1,5 OHM 1%
R 50526	870042900500	KSW NB 0207 1,5 OHM 5%
R 50531	870536905500	MOW 0617 180 OHM 5%
R 52501	870532901700	MOW 0411 4,7 OHM 5%
R 52503	873023923900	DRW SI ST7 3W 39 OHM 5%
R 52505	870536901600	MOW 0617 4,3 OHM 5%
R 52506	870536901600	MOW 0617 4,3 OHM 5%
R 53508	870042909700	KSW NB 0207 10 KOHM 5%
R 53511	870522702100	MOW 0411 6,8 OHM 5%
R 53516	873028002100	DRW SI S11 7W 6,8 OHM 5%
R 53521	870536906300	MOW 0617 390 OHM 5%
R 54501	873500303300	DRW 0,75W 0,33 OHM 10%
R 54511	873500303300	DRW 0,75W 0,33 OHM 10%
R 55512	870536906500	MOW 0617 470 OHM 5%
R 55514	870123081700	NKS 3 4,7 OHM 5%
R 58501	876519810400	MSW 0207 20 KOHM 1%
R 58502	876519808600	MSW 0207 3,6 KOHM 1%
R 58524	870001134500	KSW 0204 1 MOHM 5%
R 60502	870006935600	KSW 0617 3 MOHM 2%
R 60504	870006934100	KSW 0617 680 KOHM 2%
R 60508	873506730100	DRW 7 15 KOHM 10%
R 60512	870000743200	KSW 0207 20 OHM 5%
R 60801	876521212700	MSW 0411 180 KOHM 5%
R 60802	831140107400	VDR SIOV-S07K385GS3
R 60803	870042904500	KSW NB 0207 68 OHM 5%
R 60806	876504915300	MSW SI 0414 2,2 MOHM
R 61508	879005005400	ESTR.SK10-A 22 KOHM LIN

POS. NR. POS. NO.	MATERIAL-NR. PART NUMBER	BEZEICHNUNG DESCRIPTION
R 61512	870042904900	KSW NB 0207 100 OHM 5%
R 61518	870522732100	MOW 0411 100 KOHM 10%
R 61527	870536930100	MOW 0617 15 KOHM 10%
R 61533	873506404900	DRW 4 100 OHM 5%
R 62501	876504914500	MSW SI 0414 1 MOHM 5%
R 62502	831100501700	NTC 4,7 OHM 30%
R 62503	831140127500	VDR SIOV-S14K275E2S11M5
R 62549	876634915500	MSW SI 0414 2,7 MOHM 5%
R 64003	870240109700	KMW 0411 10 KOHM 10%
R 64006	293035521200	FOKUS-FUSSPUNKTREGLER
SI 52501	831561202700	SI LOET T315MA 250V
SI 60501	831562000300	SI 5X20 T2A L 250V
SI 61521	831562022500	SI LOET T2A 250V
SI 61524	831562102700	SI LOET T2,5A 250V
SI 61538	831561820000	SI LOET T1A 250V
SI 61561	831562022500	SI LOET T2A 250V
SI 61566	831562022500	SI LOET T2A 250V
SI 62501	831562250300	SI 5X20 T3,15A H 250V
T 21511	830340129900	TRANS BF299G
T 50528	830221054400	TRANS B0544B
T 50529	830221054300	TRANS B0543B
T 52503	830221068200	TRANS B0679A
T 53501	830262533100	TRANS 25C5331
T 60506	830263829800	TRANS 25K2699
T 64016	830328763900	TRANS BC639
T 64110	830320554800	TRANS BC548B/BC547B
TC 22503	831001000800	TRIAC BTB08-600CW F17
TR 52501	092468679700	UEBERTRAGER
TR 53500	292016800701	TRANSFORMER DRIVER
		DIODEN-SPLIT TRAF0
TR 60500	292015849702	TRANSFORMER DIODE SPLIT
TR 60801	292016299701	SPERRWANDLERTRAF0
		SPERRWANDLERTRAF0
		STANDBY
		B.O. TYPE CONVERTER
TR 64001	292014499700	TRANSFORMER STANDBY
		FOKUSSIERUNG/SUEBERTRAGER
		FOCUSING TRANSFORMER

POS. NR. POS. NO.	ABB. FIG.	MATERIAL-NR. PART NUMBER	ANZ. QTY.	BEZEICHNUNG D	DESCRIPTION GB
		297040197800		CHASSIS-FS-STEREO DIGI 100 CUC 1838 KEIN E-TEIL	CHASSIS TV STEREO DIGI 100 CUC 1838 NO SPARE PART
0200.000		295042622400	X	BAUSTEIN SIGNAL/ZF+TUNER	MODULE SIGNAL/IF-TUNER
0215.000		297033571100		TASTSCHALTER PROGRAMM +	KEY SWITCH PROGRAMME +
0215.000		297033571100		TASTSCHALTER PROGRAMM -	KEY SWITCH PROGRAMME -
0215.000		297033571100		TASTSCHALTER LAUTSTAERKE +	KEY SWITCH VOLUME +
0215.000		297033571100		TASTSCHALTER LAUTSTAERKE -	KEY SWITCH VOLUME -
0216.000		295017660102		TASTENSATZ PROGRAMM/LAUTSTAERKE	KEY SET PROGRAMME/VOLUME
0240.000		293033904200		KOPFHOERERBUCHSE 3,5mm O.SCHALTER	HEADPHONE SOCKET 3,5mm W/O SWITCH
0241.000		293031680503		CINCH-BUCHSE 3-FACH FBAS/NF L,R	CINCH SOCKET 3 FOLD FBAS/AF L,R
0400.000		295042032100	X	BAUSTEIN FEATURE	MODULE FEATURE
0450.000		297006540102		HALTER FOKUSPLATTE	HOLDER FOCUS BOARD
0450.000		297006521102		HALTER BAUSTEIN	HOLDER MODULE
0900.000	Δ	292013610400		FOKUS U.JG2-REGLER	FOCUS AND UG2-CONTROLLER
0910.000		292107030200		FOKUSLEITUNG	FOCUS CABLE
0921.000		297006400100		KLAMMER REGLER	CLAMP CONTROL
1000.000		096211130206	4	SICHERUNGSHALTER SI60501/62501	FUSE HOLDER SI60501/62501
		293050254300		DYN.FOKUSSIERUNGSPLATTE KEIN E-TEIL	DYN.FOCUSING BOARD NO SPARE PART
2000.000	Δ	297033910100		NETZSCHALTER O.WISCHER	POWER SWITCH W/O WIPER
2200.000	Δ	293033994802		NETZ EINBAUGERAETESTECKER	APPLIANCE COUPLER
2400.000		293031530107	2	MONTAGECLIP T53501/60506	MOUNTING CLIP T53501/60506
2410.000		293031530208		MONTAGECLIP IC40510	MOUNTING CLIP IC 40510
2430.000		293031531208	8	MONTAGECLIP D53571/53572/61516/ 61521/61524/IC50510/T50528/50529	MOUNTING CLIP D53571/53572/61516/ 61521/61524/IC50510/T50528/50529
2430.000		293031531802	WW. 8	MONTAGECLIP D53571/53572/61516/ 61521/61524/IC50510/T50528/50529	MOUNTING CLIP D53571/53572/61516/ 61521/61524/IC50510/T50528/50529
2450.000		293031531605		MONTAGECLIP T52503	MOUNTING CLIP T52503
2455.000		293031561600	2	ISOLIERUNG D60019/60021	INSULATION D60019/60021
2455.000		293031561700	WW. 2	ISOLIERUNG D60019/60021	INSULATION D60019/60021
2470.000		293031562000	6	FOLIE WAERMELEITEND D61516/ 61521/61524/IC50510/T50528/50529	FOIL HEAT CONDUCTING D61516/ 61521/61524/IC50510/T50528/50529
2480.000		293031562100	2	FOLIE WAERMELEITEND D53571/53572	FOIL HEAT CONDUCTING D53571/53572
2485.000		293031562300		FOLIE WAERMELEITEND T53501	FOIL HEAT CONDUCTING T53501
2490.000		293031562800	2	FOLIE WAERMELEITEND D60019/60021	FOIL HEAT CONDUCTING D60019/60021
2495.000		293031563301		FOLIE WAERMELEITEND T60506	FOIL HEAT CONDUCTING T60506
				X = SIEHE GESONDERTE E-LISTE WW. = WAHLWEISE	X = SEE SEPARATE PARTS LIST WW. = OPTIONAL

POS. NR. POS. NO.	MATERIAL-NR. PART NUMBER	BEZEICHNUNG DESCRIPTION	POS. NR. POS. NO.	MATERIAL-NR. PART NUMBER	BEZEICHNUNG DESCRIPTION
C 40502	845299615000	ELKO 2200UF 20% 25V	C 60518	851591140300	FOKO FKP1 0,01UF 5% 1250V
C 50512	845299614700	ELKO 1000UF 20% 25V	C 60519	865006704600	KERKO HV C 100PF 20% 1KV
C 50526	845299614700	ELKO 1000UF 20% 25V	C 60521	865006704600	KERKO HV C 100PF 20% 1KV
C 53512	851591160200	FOKO FKP1 142PF 2,5% 2000V	C 60523	865008112500	KERKO HV C 1000PF 20% 1KV
C 53571	851591471900	FOKO FKP1 0,012UF 3,5% 2000V	C 60524	865008112500	KERKO HV C 1000PF 20% 1KV
C 60506	865006704600	KERKO HV C 100PF 20% 1KV	C 60526	865008112500	KERKO HV C 1000PF 20% 1KV
C 60509	851591104000	FOKO FKP1 220PF 10% 1600V	C 60527	865008112500	KERKO HV C 1000PF 20% 1KV
C 60512	865008111100	KERKO HV C 270PF 20% 2KV	C 60529	851179301800	FOKO MP3 0,1UF 20% 275V

Es gelten die Vorschriften und Sicherheitshinweise gemäß dem Service Manual "Sicherheit", Mat.-Nummer 720108000000, sowie zusätzlich die eventuell abweichenden, landesspezifischen Vorschriften!



The regulations and safety instructions shall be valid as provided by the "Safety" Service Manual, part number 720108000000, as well as the respective national deviations.

ÄNDERUNGEN VORBEHALTEN / SUBJECT TO ALTERATION

ÄNDERUNGEN VORBEHALTEN / SUBJECT TO ALTERATION

POS. NR. POS. NO.	MATERIAL-NR. PART NUMBER	BEZEICHNUNG DESCRIPTION
C 60801	865006703100	KERKO HV C 47PF 20% 2KV
C 60802	865008112500	KERKO HV C 1000PF 20% 1KV
C 61511	865006704600	KERKO HV C 100PF 20% 1KV
C 61512	865006704600	KERKO HV C 100PF 20% 1KV
C 61514	851591103800	FOKO FKP1 100PF 10% 1600V
C 61521	865006704600	KERKO HV C 100PF 20% 1KV
C 61522	845209705500	ELKO #16 600/680UF +50-20% 63V
C 61524	865006704600	KERKO HV C 100PF 20% 1KV
C 61561	865006704600	KERKO HV C 100PF 20% 1KV
C 61562	845209701500	ELKO #39 1000UF +50-20% 25V
C 61563	845209701500	ELKO #39 1000UF +50-20% 25V
C 61566	865006704600	KERKO HV C 100PF 20% 1KV
C 62501	851179304700	FOKO MP3/KT 0,47UF20% 275V
C 62502	851179304700	FOKO MP3/KT 0,47UF20% 275V
C 62521	866009823400	KERKO SI 1000PF 20% 400V
C 62548	866009823800	KERKO SI 2200PF 20% 400V
C 62549	866009823400	KERKO SI 1000PF 20% 400V
C 64001	850220006600	FOKO WIMADUR 1500PF 20% 6000V
C 64002	850220006600	FOKO WIMADUR 1500PF 20% 6000V
C 64003	853150522100	FOKO MKT 680PF 20% 15KV
C 64006	851591160900	FOKO FKP1 180PF -5% 2000V
CD 21501	833050414800	MELF DIODE MCL4148
CD 21502	833050414800	MELF DIODE MCL4148
CD 21503	833050414800	MELF DIODE MCL4148
CD 21506	832531310300	MELF DIODE BAV103
CD 21666	833050414800	MELF DIODE MCL4148
CD 40536	833050414800	MELF DIODE MCL4148
CD 52503	833050414800	MELF DIODE MCL4148
CD 53519	833050414800	MELF DIODE MCL4148
CD 55503	830945504400	MELF Z-DIODE 4,3B 0,5W
CD 55504	833050414800	MELF DIODE MCL4148
CD 57501	833050414800	MELF DIODE MCL4148
CD 57503	833050414800	MELF DIODE MCL4148
CD 57504	833050414800	MELF DIODE MCL4148
CD 57506	830945515000	MELF Z-DIODE 15VB 0,5W
CD 58501	833050414800	MELF DIODE MCL4148
CD 58504	833050414800	MELF DIODE MCL4148
CD 58507	830945502800	MELF Z-DIODE 2,7B 0,5W
CD 58511	833050414800	MELF DIODE MCL4148
CD 58512	833050414800	MELF DIODE MCL4148
CD 58521	833050414800	MELF DIODE MCL4148
CD 58522	833050414800	MELF DIODE MCL4148
CD 60811	833010130200	MELF DIODE BAV 302
CD 60812	832561034100	SMD DIODE STPS340U
CD 61528	832538430100	SMD Z-DIODE BZX84B30
CD 61538	832561034100	SMD DIODE STPS340U
CD 61548	832561034100	SMD DIODE STPS340U
CD 61558	832561034100	SMD DIODE STPS340U
CD 70501	830945505100	MELF-Z DIODE 5,1C 0,5W
CD 85513	830945505200	MELF-Z DIODE 5,1B 0,5W
CIC 21660	830598600000	SMD IC 74LV00
CL 60504	810498233100	SMD DAEMPF-PERLE
CT 21670	830100484800	SMD TRANS BC848B/BC847B
CT 40531	830100484800	SMD TRANS BC848B/BC847B
CT 40591	830100484800	SMD TRANS BC848B/BC847B
CT 44515	830100484800	SMD TRANS BC848B/BC847B
CT 57506	830100484800	SMD TRANS BC848B/BC847B
CT 58512	830100484800	SMD TRANS BC848B/BC847B
CT 60806	830100685800	SMD TRANS BC858C/BC857C
CT 61585	830100484800	SMD TRANS BC848B/BC847B
CT 85505	830100385800	SMD TRANS BC858B/BC857B
CT 85510	830100385800	SMD TRANS BC858B/BC857B
D 21512	830921502000	DIODE 1N4004
D 40532	830921504500	DIODE 1N4148
D 50513	830951627200	DIODE BYV27/200

POS. NR. POS. NO.	MATERIAL-NR. PART NUMBER	BEZEICHNUNG DESCRIPTION
D 52506	830921502000	DIODE 1N4004
D 53508	830920100500	DIODE BA157
D 53519	830970900300	Z DIODE ZY51
D 53571	830920435900	DIODE BY359 1500
D 53572	830920423000	DIODE BY229-600
D 54501	830920100500	DIODE BA157
D 54511	830920100500	DIODE BA157
D 55512	830972033300	Z DIODE 33C 0,5W
D 60019	830919780600	DIODE STTA806DI
D 60019	830919780700	WW.DIODE STTA806D
D 60021	830919780600	DIODE STTA806DI
D 60021	830919780700	WW.DIODE STTA806D
D 60512	830951675400	DIODE BYT53B
D 60523	830856038400	GLR.SKB380C1500
D 61503	830972009900	Z DIODE 10B 0,5W
D 61511	830951603800	DIODE BYV38
D 61512	830951603800	DIODE BYV38
D 61516	830951679800	DIODE BYT08 P-1000
D 61521	830919682000	DIODE STPR820D
D 61524	830919682000	DIODE STPR820D
D 61533	830920100500	DIODE BA157
D 61561	830951717200	DIODE BYW172D
D 61566	830951717200	DIODE BYW172D
D 64010	830966306800	Z-DIODE BZT03D68
D 64011	830920002100	DIODE BAV21
D 64012	830920002100	DIODE BAV21
D 64013	830920002100	DIODE BAV21
D 64014	830920002100	DIODE BAV21
D 85501	830998411600	LE-DIODE L-115WEGW
FS 64001	293032300200	FUNKENSTRECKE 1,6KV
IC 40510	830536729700	IC TDA7297
IC 50510	830512597900	IC STV9379A
IC 55510	830533814500	IC TDA8145
IC 58510	830520439300	IC LM358N
IC 60510	830533464700	IC TDA16846-2
IC 60801	830547026400	IC TNY264
IC 60817	830546543100	IC TS4311Z-AP
IC 61510	830520435700	IC LM358N
IC 61535	830520497800	IC L4978
IC 61545	830520497800	IC L4978
IC 61555	830520497800	IC L4978
IC 84501	830546123600	IC TSOP1236
L 53501	810498205600	FERRITPERLE HF70 BTL 3,5X
L 53502	810498205600	FERRITPERLE HF70 BTL 3,5X
L 53503	810498205600	FERRITPERLE HF70 BTL 3,5X
L 53511	814050524900	DR A AX-GA 10UH 10%
L 53512	092401144040	DROSSEL 1,5 MH CHOKE
L 53521	292031229500	LINEARITAETSREGLER LINEARITY CONTROL
L 53574	092468596601	BRUECKENSPULE M.KERN BRIDGECOIL W.CORE
L 55514	092458160100	O/W AUSKOPPELSPULE E/W COUPLING COIL
L 60506	810498208100	FERRITPERLE 0,676UH
L 60507	810498208000	FERRITPERLE 0,676UH
L 60518	810498208000	FERRITPERLE 0,676UH FERRITE BEAD
L 60528	292017119700	SPEICHERDROSSEL STORAGE CHOKE
L 60812	814052499200	SIEB-DR 10UH 15% FILTER CHOKE
L 61511	810498201400	DAEMPF-PERLE 433003038102
L 61514	810498201400	DAEMPF-PERLE 433003038102
L 61521	810498201400	DAEMPF-PERLE 433003038102
L 61524	810498201400	DAEMPF-PERLE 433003038102 DAMPING BEAD

ÄNDERUNGEN VORBEHALTEN / SUBJECT TO ALTERATION

POS. NR. POS. NO.	MATERIAL-NR. PART NUMBER	BEZEICHNUNG DESCRIPTION
L 61527	814052499200	SIEB-DR 10UH 15%
L 61538	814052499500	SIEB-DR 330UH FILTER CHOKE
L 61548	814052106800	SPEICHER-DR 67UH
L 61548	814052105900	SPEICHER-DR 59UH 2,5A STORAGE CHOKE
L 61549	814052499200	SIEB-DR 10UH 15% FILTER CHOKE
L 61558	814052106700	SPEICHER-DR EF16 67UH
L 61558	814052106800	SPEICHER-DR 67UH
L 61558	814052105900	SPEICHER-DR 59UH 2,5A STORAGE CHOKE
L 61561	810498201400	DAEMPF-PERLE 433003038102 DAMPING BEAD
L 61562	814050506500	DR A AX-GA 47UH 5% CHOKE
L 61566	810498201400	DAEMPF-PERLE 433003038102 DAMPING BEAD
L 61567	814050506500	DR A AX-GA 47UH 5% CHOKE
L 62501	295008359700	ENTSTOER-DR 2X22MH INTERFERENCE CHOKE
OK 22505	830600036200	OPTOKOPPLER
OK 22505	830600024200	WW.OPTOKOPPLER
OK 60531	830600001200	OPTOKOPPLER
OK 60546	830600001200	OPTOKOPPLER
OK 60805	830600061500	OPTOKOPPLER OPTO COUPLER
R 21512	870000754900	KSW 0207 1,5 MOHM 5%
R 21523	870532901700	MOW 0411 4,7 OHM 5%
R 22501	831120001800	PTC DUO B59709-T60-A110
R 22504	870004912100	KSW 0411 100 KOHM 5%
R 22506	870022905700	KSW NB 0207 220 OHM 5%
R 40502	873229600900	DRW 6,5 2,2 OHM 10%
R 50507	876642460500	MSW 0207 1,5 OHM 1%
R 50508	876642460500	MSW 0207 1,5 OHM 1%
R 50526	870042900500	KSW NB 0207 1,5 OHM 5%
R 50531	870536905500	MOW 0617 180 OHM 5%
R 52501	870532901700	MOW 0411 4,7 OHM 5%
R 52503	873023923900	DRW SI ST7 3W 39 OHM 5%
R 52505	870536901600	MOW 0617 4,3 OHM 5%
R 52506	870536901600	MOW 0617 4,3 OHM 5%
R 53508	870042909700	KSW NB 0207 10 KOHM 5%
R 53511	870522702100	MOW 0411 6,8 OHM 5%
R 53516	873028002100	DRW SI S11 7W 6,8 OHM 5%
R 53521	870536906300	MOW 0617 390 OHM 5%
R 54501	873500303300	DRW 0,75W 0,33 OHM 10%
R 54511	873500303300	DRW 0,75W 0,33 OHM 10%
R 55512	870536906500	MOW 0617 470 OHM 5%
R 55514	870123081700	NKS 3 4,7 OHM 5%
R 58501	876519810400	MSW 0207 20 KOHM 1%
R 58502	876519808600	MSW 0207 3,6 KOHM 1%
R 58524	870001134500	KSW 0204 1 MOHM 5%
R 60502	870006935600	KSW 0617 3 MOHM 2%
R 60504	870006934100	KSW 0617 680 KOHM 2%
R 60508	873506730100	DRW 7 15 KOHM 10%
R 60512	870000743200	KSW 0207 20 OHM 5%
R 60801	876521212700	MSW 0411 180 KOHM 5%
R 60802	831140107400	VDR SIOV-S07K385GS3
R 60803	870042904500	KSW NB 0207 68 OHM 5%
R 60806	876504915300	MSW SI 0414 2,2 MOHM
R 61508	879005005400	ESTR.SK10-A 22 KOHM LIN
R 61512	870042904900	KSW NB 0207 100 OHM 5%
R 61518	870522732100	MOW 0411 100 KOHM 10%

Es gelten die Vorschriften und Sicherheitshinweise gemäß dem Service Manual "Sicherheit", Mat.-Nummer 720108000000, sowie zusätzlich die eventuell abweichenden, landesspezifischen Vorschriften!



The regulations and safety instructions shall be valid as provided by the "Safety" Service Manual, part number 720108000000, as well as the respective national deviations.

ÄNDERUNGEN VORBEHALTEN / SUBJECT TO ALTERATION



Ersatzteilliste  
Spare Parts List

8 / 2002

CHASSIS-FS-STEREO CUC 1934 DIGI 100  
CHASSIS FS STEREO CUC 1934 DIGI 100

MATERIAL-NR. / PART NO.: 297040190600

POS. NR. POS. NO.	MATERIAL-NR. PART NUMBER	BEZEICHNUNG DESCRIPTION
----------------------	-----------------------------	----------------------------

R 21523	△	870532901700	MOW 0411 4,7 OHM 5%
R 22501	△	831120001800	PTC DUO B59709-T60-A110
R 22504	△	870004912100	KSW 0411 100 KOHM 5%
R 22506	△	870022905700	KSW NB 0207 220 OHM 5%
R 40502	△	873229600000	DRW 6,5 0,56 OHM 10%
R 50507	△	876642460800	MSW 0207 2 OHM 1%
R 50508	△	876642460800	MSW 0207 2 OHM 1%
R 50526	△	870042900500	KSW NB 0207 1,5 OHM 5%
R 50529	△	876635705900	MSW 0414 270 OHM 5%
R 52501	△	870532122100	MOW 0411 6,8 OHM 5%
R 52503	△	873023923900	DRW SI ST7 3W 39 OHM 5%
R 52505	△	870536901700	MOW 0617 4,7 OHM 5% LI
R 52506	△	870536901700	MOW 0617 4,7 OHM 5% LI
R 53508	△	870042909700	KSW NB 0207 10 KOHM 5% ST
R 53511	△	870522702100	MOW 0411 6,8 OHM 5%
R 53516	△	873028002100	DRW SI S11 7W 6,8 OHM 5%
R 53521	△	870536926700	MOW 0617 560 OHM 10% LI
R 54501	△	873500303300	DRW 0,75W 0,33 OHM 10%
R 54511	△	873500303300	DRW 0,75W 0,33 OHM 10%
R 55512	△	870536906500	MOW 0617 470 OHM 5% LI
R 55514	△	870123081700	NKS 3 4,7 OHM 5%
R 58501	△	876519810400	MSW 0207 20 KOHM 1%
R 60502	△	870006935600	KSW 0617 3 MOHM 2%
R 60504	△	870006934100	KSW 0617 680 KOHM 2%
R 60508	△	873018970100	DRW 9 15 KOHM 10%
R 60512	△	870000743200	KSW 0207 20 OHM 5%
R 60801	△	876521212700	MSW 0411 180 KOHM 5%
R 60802	△	831140107400	VDR SIOV-S07K385GS3
R 60803	△	870042904500	KSW NB 0207 68 OHM 5%
R 60806	△	876504915300	MSW SI 0414 2,2 MOHM VDE
R 61508	△	879005005400	ESTR.SK10-A 22 KOHM LIN
R 61512	△	870042904900	KSW NB 0207 100 OHM 5% ST
R 61518	△	870522732100	MOW 0411 100 KOHM 10%
R 61527	△	870536930100	MOW 0617 15 KOHM 10% LI
R 61533	△	873506404900	DRW 4 100 OHM 5%
R 62501	△	876504914500	MSW SI 0414 1 MOHM 5% VDE
R 62502	△	831100501700	NTC 4,7 OHM 30%
R 62549	△	876634915500	MSW SI 0414 2,7 MOHM 5% LI
R 64003	△	870240109700	KMW 0411 10 KOHM 10%
R 64006	△	293035521200	FOKUS-FUSSPUNKTREGLER

SI 52501	△	831561202700	SI LOET T315MA 250V
SI 60501	△	831562000300	SI 5X20 T2A L 250V
SI 61521	△	831562300800	SI LOET T4A 250V
SI 61524	△	831562102700	SI LOET T2,5A 250V
SI 61538	△	831561820000	SI LOET T1A 250V
SI 61561	△	831562022500	SI LOET T2A 250V
SI 61566	△	831562022500	SI LOET T2A 250V

T 21511	△	830340129900	TRANS.BF299 G
T 50528	△	830221054400	TRANS BD544B
T 50529	△	830221054300	TRANS BD543B
T 52503	△	830221068200	TRANS.BD 679A
T 53501	△	830262533100	TRANS 2SC5331
T 60506	△	830263829800	TRANS 2SK2699
T 64016	△	830328763900	TRANS.BC 639
T 64110	△	830320554800	TRANS BC548B/ BC547B

TC 22503	△	831001000800	TRIAC BTB08-600CW
----------	---	--------------	-------------------

TR 52501	△	092468679700	UEBERTRAGER TRANSFORMER
TR 53500	△	292016800901	DIODEN-SPLIT TRAF0 DIGI DIODE SPLIT TRANSFORMER

POS. NR. POS. NO.	MATERIAL-NR. PART NUMBER	BEZEICHNUNG DESCRIPTION
----------------------	-----------------------------	----------------------------

TR 60500	△	292015919701	SPERRWANDLERTRAF0 REVERSE CONVERTER TRANSFORMER
TR 60801	△	292016299701	SPERRWANDLERTRAF0 REVERSE CONVERTER TRANSFORMER
TR 64001	△	292014499700	FOKUSSIERUNGSEBERTRAGER FOCUSING TRANSFORMER

POS. NR. POS. NO.	ABB. FIG.	MATERIAL-NR. PART NUMBER	ANZ. QTY.	BEZEICHNUNG ①	DESCRIPTION ②
		297040190600		CHASSIS-FS-STEREO CUC 1934 DIGI 100 KEIN E-TEIL	CHASSIS TV STEREO CUC 1934 DIGI 100 NO SPARE PART
0100.000		295042622400	X	BAUSTEIN SIGNAL / ZF-TUNER	MODULE SIGNAL / IF TUNER
0400.000		295042032200	X	BAUSTEIN FEATURE	MODULE FEATURE
0451.000		297006521102		HALTER BAUSTEIN	HOLDER MODULE
1000.000	△	096211130206	4	SICHERUNGSHALTER SI60501/62051	FUSE HOLDER SI60501/62051
2200.000		293033994802		NETZ EINBAUGERAETESTECKER	APPLIANCE COUPLER W.CABLE
2400.000		293031530107	2	MONTAGECLIP T53501/60506	MOUNTING CLIP T53501/60506
2410.000		293031530208		MONTAGECLIP IC40510	MOUNTING CLIP IC40510
2420.000		293031531208	8	MONTAGECLIP IC50510/ D53571/53572/61516/ D61521/61524/T50528/50529	MOUNTING CLIP IC50510/ D53571/53572/61516/ D61521/61524/T50528/50529
2430.000		293031531605		MONTAGECLIP T52503	MOUNTING CLIP T52503
2440.000		293031561600		ISOLIERUNG D60019	INSULATING D60019
2445.000		293031561700		ISOLIERUNG D60021	INSULATION D60021
2460.000		293031562000	7	FOLIE WAERMELEITEND IC50510 D61516/61521/61524/ T50528/50529/52503	FOIL HEAT CONDUCTING IC50510 D61516/61521/61524/ T50528/50529/52503
2470.000		293031562100	2	FOLIE WAERMELEITEND D53571/53572	FOIL HEAT CONDUCTING D53571/53572
2480.000		293031562300		FOLIE WAERMELEITEND T53501	FOIL HEAT CONDUCTING T53501
2490.000		293031562800	2	FOLIE WAERMELEITEND D60019/60021	FOIL HEAT CONDUCTING D60019/60021

X = SIEHE GESONDERTE E-LISTE  
WW.= WAHLWEISE

X = SEE SEPARATE PARTS LIST  
WW.= OPTIONAL

POS. NR. POS. NO.	MATERIAL-NR. PART NUMBER	BEZEICHNUNG DESCRIPTION
----------------------	-----------------------------	----------------------------

C 21631	842609807100	ELKO 2,2UF 350V	
C 40502	845299615000	ELKO 2200UF 20% 25V	
C 50512	845299615000	ELKO 2200UF 20% 25V	
C 50526	845299865000	ELKO 2200UF 20% 25V	
C 53512	851591160200	FOKO FKP1 142PF 2,5% 2000V	
C 53571	851591472000	FOKO FKP1 0,0125UF 3,5% 2000V	
C 60506	865006704600	KERKO HV C 100PF 20% 1KV	
C 60509	851591104000	FOKO FKP1 220PF 10% 1600V	
C 60512	865008111100	KERKO HV C 270PF 20% 2KV	
C 60518	851591140300	FOKO FKP1 0,01UF 5% 1250V	
C 60519	865006704600	KERKO HV C 100PF 20% 1KV	
C 60521	865006704600	KERKO HV C 100PF 20% 1KV	
C 60523	865008112500	KERKO HV C 1000PF 20% 1KV	
C 60524	865008112500	KERKO HV C 1000PF 20% 1KV	
C 60526	865008112500	KERKO HV C 1000PF 20% 1KV	
C 60527	865008112500	KERKO HV C 1000PF 20% 1KV	
C 60528	△	844330315000	ELKO SNT #3 150UF 20% 450V
C 60529	△	851179301800	FOKO MP3 0,1UF 20% 275VW
C 60801	865006703100	KERKO HV C 47PF 20% 2KV	
C 60802	865008112500	KERKO HV C 1000PF 20% 1KV	
C 61511	865006704600	KERKO HV C 100PF 20% 1KV	
C 61512	865006704600	KERKO HV C 100PF 20% 1KV	

POS. NR. POS. NO.	MATERIAL-NR. PART NUMBER	BEZEICHNUNG DESCRIPTION
----------------------	-----------------------------	----------------------------

C 61513	845202733600	ELKO #41 22UF +50-20% 350V	
C 61514	851591103800	FOKO FKP1 100PF 10% 1600V	
C 61516	845209713100	ELKO #31 100UF 250V	
C 61521	865006704600	KERKO HV C 100PF 20% 1KV	
C 61524	865006704600	KERKO HV C 100PF 20% 1KV	
C 61561	865006704600	KERKO HV C 100PF 20% 1KV	
C 61562	845209701500	ELKO #39 1000UF +50-20% 25V	
C 61563	845209701500	ELKO #39 1000UF +50-20% 25V	
C 61566	865006704600	KERKO HV C 100PF 20% 1KV	
C 62501	△	851179304700	FOKO MP3/KT 0,47UF20% 275VW
C 62502	△	851179304700	FOKO MP3/KT 0,47UF20% 275VW
C 62521	△	866009823400	KERKO SI 1000PF 20% 400V
C 62548	△	866009823800	KERKO SI 2200PF 20% 400V
C 62549	△	866009823400	KERKO SI 1000PF 20% 400V
CD 21636	833050414800	MELF DIODE MCL4148	
CD 21666	833050414800	MELF DIODE MCL4148	
CD 40536	833050414800	MELF DIODE MCL4148	
CD 52503	833050414800	MELF DIODE MCL4148	
CD 53519	833050414800	MELF DIODE MCL4148	
CD 55503	830945504400	MELF Z-DIODE 4,3 B 0,5W	
CD 55504	833050414800	MELF DIODE MCL4148	

Es gelten die Vorschriften und Sicherheitshinweise gemäß dem Service Manual "Sicherheit", Mat.-Nummer 720108000000, sowie zusätzlich die eventuell abweichenden, landesspezifischen Vorschriften!



The regulations and safety instructions shall be valid as provided by the "Safety" Service Manual, part number 720108000000, as well as the respective national deviations.

ÄNDERUNGEN VORBEHALTEN / SUBJECT TO ALTERATION

ÄNDERUNGEN VORBEHALTEN / SUBJECT TO ALTERATION





POS. NR. POS. NO.	MATERIAL-NR. PART NUMBER	BEZEICHNUNG DESCRIPTION
----------------------	-----------------------------	----------------------------

OK 60531	830600001200	OPTOKOPPLER
OK 60546	830600001200	OPTOKOPPLER
OK 60805	830600061500	OPTOKOPPLER OPTO COUPLER
R 21512	870000754900	KSW 0207 1,5 MOHM 5%
R 21523	870532122100	MOW 0411 6,8 OHM 5%
R 22501	831120001800	PTC DUO B59709-T60-A110
R 22504	870004912100	KSW 0411 100 KOHM 5%
R 22506	870022905700	KSW NB 0207 220 OHM 5%
R 40502	873229600900	DRW 6,5 2,2 OHM 10%
R 50507	876642461000	MSW 0207 2,4 OHM 1%
R 50508	876642461000	MSW 0207 2,4 OHM 1%
R 50526	870042900500	KSW NB 0207 1,5 OHM 5%
R 50529	876635705900	MSW 0414 270 OHM 5%
R 52501	870532122100	MOW 0411 6,8 OHM 5%
R 52503	873023923900	DRW SI ST7 3W 39 OHM 5%
R 52505	870536901600	MOW 0617 4,3 OHM 5%
R 52506	870536901600	MOW 0617 4,3 OHM 5%
R 53508	870042909700	KSW NB 0207 10 KOHM 5%
R 53511	870522702100	MOW 0411 6,8 OHM 5%
R 53516	873028002100	DRW SI S11 7W 6,8 OHM 5%
R 53521	870536906300	MOW 0617 390 OHM 5%
R 54501	873500303300	DRW 0,75W 0,33 OHM 10%
R 55512	870536926900	MOW 0617 680 OHM 10%
R 55514	870123081700	NKS 3 4,7 OHM 5%
R 58501	876519810400	MSW 0207 20 KOHM 1%
R 58502	876519808600	MSW 0207 3,6 KOHM 1%
R 58524	870001134500	KSW 0204 1 MOHM 5%
R 60502	870006935600	KSW 0617 3 MOHM 2%
R 60504	870006934100	KSW 0617 680 KOHM 2%
R 60508	873018970100	DRW 9 15 KOHM 10%
R 60512	870000743200	KSW 0207 20 OHM 5%
R 60801	876521212700	MSW 0411 180 KOHM 5%
R 60802	831140107400	VDR SIOV-S07K385GS3
R 60803	870042904500	KSW NB 0207 68 OHM 5%
R 60806	876504915300	MSW SI 0414 2,2 MOHM
R 61508	879005005400	ESTR.SK10-A 22 KOHM LIN
R 61512	870042904900	KSW NB 0207 100 OHM 5%
R 61518	870522732100	MOW 0411 100 KOHM 10%
R 61527	870536930100	MOW 0617 15 KOHM 10%
R 61533	873506404900	DRW 4 100 OHM 5%
R 62501	876504914500	MSW SI 0414 1 MOHM 5%
R 62502	831100501700	NTC 4,7 OHM 30%
R 62503	831140127500	VDR SIOV-S14K275E2S11M5
R 62549	876634915500	MSW SI 0414 2,7 MOHM 5%

SI 52501	831561202700	SI LOET T315MA 250V
SI 60501	831562000300	SI 5X20 T2A L 250V
SI 61521	831562022500	SI LOET T2A 250V
SI 61524	831562102700	SI LOET T2,5A 250V
SI 61538	831561820000	SI LOET T1A 250V
SI 61561	831562022500	SI LOET T2A 250V
SI 61566	831562022500	SI LOET T2A 250V
SI 62501	831562250300	SI 5X20 T3,15A H 250V

T 50528	830221054400	TRANS BD544B
T 50529	830221054300	TRANS BD543B
T 52503	830221068200	TRANS BD679A
T 53501	830262533100	TRANS 2SC5331
T 60506	830263829800	TRANS 2SK2269

TC 22503	831001000800	TRIAC BTB08-600CW F17
----------	--------------	-----------------------

TR 52501	092468679700	UEBERTRAGER TRANSFORMER DRIVER
----------	--------------	-----------------------------------

POS. NR. POS. NO.	MATERIAL-NR. PART NUMBER	BEZEICHNUNG DESCRIPTION
----------------------	-----------------------------	----------------------------

TR 53500	292016800300	TRAFO DIODEN-SPLIT TRANSFORMER DIODE SPLIT
TR 60500	292015819700	SPERRWANDLERTRAFO B.O.TYPE CONVERTER TRANSFORMER
TR 60801	292016299701	SPERRWANDLERTRAFO STAND BY B.O.TYPE CONVERTER TRANSFORMER STAND BY

Ersatzteilliste  
Spare Parts List

8 / 2002

CHASSIS-TV-STEREO CUC 1934 DIGI 100  
CHASSIS FS STEREO CUC 1934 DIGI 100

MATERIAL-NR. / PART NO.: 297040193000

POS. NR. POS. NO.	ABB. FIG.	MATERIAL-NR. PART NUMBER	ANZ. QTY.	BEZEICHNUNG ①	DESCRIPTION ②
		297040193000		CHASSIS-FS-STEREO CUC 1934 DIGI 100 KEIN E-TEIL	CHASSIS TV STEREO CUC 1934 DIGI 100 NO SPARE PART
0100.000		295042622400	X	BAUSTEIN SIGNAL / ZF-TUNER	MODULE SIGNAL / IF+TUNER
0400.000		295042032100	X	BAUSTEIN FEATURE	MODULE FEATURE
0420.000		297006521102		HALTER BAUSTEIN	HOLDER MODULE
1000.000		096211130206	4	SICHERUNGSHALTER SI60501/62051	FUSE HOLDER SI60501/62051
1070.000		293050254500		DYN.FOKUSSIERUNGSPLATTE	DYN.FOCUSING BOARD
1071.000		297006540102		HALTER FOKUSPLATTE	HOLDER FOCUS BOARD
2000.000	△	297033910100		NETZSCHALTER O. WISCHER	POWER SWITCH W/O WIPER
2200.000	△	293033994802		NETZ EINBAUGERAETESTECKER	APPLIANCE COUPLER W.CABLE
2400.000		293031530107	2	MONTAGECLIP T53501/60506	MOUNTING CLIP T53501/60506
2410.000		293031530208		MONTAGECLIP IC40510	MOUNTING CLIP IC40510
2420.000		293031531208	8	MONTAGECLIP IC50510/ D53571/53572/61516/ D61521/61524/T50528/50529	MOUNTING CLIP IC50510/ D53571/53572/61516/ D61521/61524/T50528/50529
2430.000		293031531605		MONTAGECLIP T52503	MOUNTING CLIP T52503
2440.000		293031561600		ISOLIERUNG D60019	INSULATING D60019
2445.000		293031561700		ISOLIERUNG D60021	INSULATION D60021
2460.000		293031562000	6	FOLIE WAERMELEITEND IC50510 D61516/61521/61524/T50528/50529	FOIL HEAT CONDUCTING IC50510 D61516/61521/61524/T50528/50529
2470.000		293031562100		FOLIE WAERMELEITEND D53572	FOIL HEAT CONDUCTING D53572
2480.000		293031562300		FOLIE WAERMELEITEND D53571	FOIL HEAT CONDUCTING D53571
2490.000		293031562800	2	FOLIE WAERMELEITEND D60019/60021	FOIL HEAT CONDUCTING D60019/60021
				X = SIEHE GESONDERTE E-LISTE	X = SEE SEPARATE PARTS LIST

POS. NR. POS. NO.	MATERIAL-NR. PART NUMBER	BEZEICHNUNG DESCRIPTION
----------------------	-----------------------------	----------------------------

C 21512	842609806100	ELKO 4,7UF 350V
C 21631	842609807100	ELKO 2,2UF 350V
C 40502	845299615000	ELKO 2200UF 20% 25V
C 50512	845299615000	ELKO 2200UF 20% 25V
C 50526	845299865000	ELKO 2200UF 20% 25V
C 53512	851591160200	FOKO FKP1 142PF 2,5% 2000V
C 53571	851591472200	FOKO FKP1 0,0143UF 3,5% 2000V
C 60506	865006704600	KERKO HV C 100PF 20% 1KV
C 60509	851591104000	FOKO FKP1 220PF 10% 1600V
C 60512	865008111100	KERKO HV C 270PF 20% 2KV
C 60518	851591140300	FOKO FKP1 0,01UF 5% 1250V
C 60519	865006704600	KERKO HV C 100PF 20% 1KV
C 60521	865006704600	KERKO HV C 100PF 20% 1KV
C 60523	865008112500	KERKO HV C 1000PF 20% 1KV
C 60524	865008112500	KERKO HV C 1000PF 20% 1KV
C 60526	865008112500	KERKO HV C 1000PF 20% 1KV
C 60527	865008112500	KERKO HV C 1000PF 20% 1KV
C 60528	844330315000	ELKO SNT #3 150UF 20% 450V
C 60529	851179301800	FOKO MP3 0,1UF 20% 275VW

POS. NR. POS. NO.	MATERIAL-NR. PART NUMBER	BEZEICHNUNG DESCRIPTION
----------------------	-----------------------------	----------------------------

C 60801	865006703100	KERKO HV C 47PF 20% 2KV
C 60802	865008112500	KERKO HV C 1000PF 20% 1KV
C 61511	865006704600	KERKO HV C 100PF 20% 1KV
C 61512	865006704600	KERKO HV C 100PF 20% 1KV
C 61513	845202733600	ELKO #41 22UF +50-20% 350V
C 61514	851591103800	FOKO FKP1 100PF 10% 1600V
C 61516	845209713100	ELKO #31 100UF 250V
C 61521	865006704600	KERKO HV C 100PF 20% 1KV
C 61524	865006704600	KERKO HV C 100PF 20% 1KV
C 61561	865006704600	KERKO HV C 100PF 20% 1KV
C 61566	865006704600	KERKO HV C 100PF 20% 1KV
C 62501	851179304700	FOKO MP3/KT 0,47UF20% 275VW
C 62502	851179304700	FOKO MP3/KT 0,47UF20% 275VW
C 62521	866009823400	KERKO SI 1000PF 20% 400V
C 62548	866009823800	KERKO SI 2200PF 20% 400V
C 62549	866009823400	KERKO SI 1000PF 20% 400V
C 64006	851591160900	FOKO FKP1 180PF -5% 2000V

CD 21636	833050414800	MELF DIODE MCL4148
CD 21666	833050414800	MELF DIODE MCL4148

Es gelten die Vorschriften und Sicherheitshinweise gemäß dem Service Manual "Sicherheit", Mat.-Nummer 720108000000, sowie zusätzlich die eventuell abweichenden, landesspezifischen Vorschriften!



The regulations and safety instructions shall be valid as regulated by the "Safety" Service Manual, part number 720108000000, as well as the respective national deviations.

ÄNDERUNGEN VORBEHALTEN / SUBJECT TO ALTERATION

ÄNDERUNGEN VORBEHALTEN / SUBJECT TO ALTERATION







POS. NR. POS. NO.	MATERIAL-NR. PART NUMBER	BEZEICHNUNG DESCRIPTION
C 61524	865006704600	KERKO HV C 100PF 20% 1KV
C 61561	865006704600	KERKO HV C 100PF 20% 1KV
C 61562	845209701500	ELKO #39 1000UF +50-20% 25V
C 61563	845209701500	ELKO #39 1000UF +50-20% 25V
C 61566	866006704600	KERKO HV C 100PF 20% 1KV
C 62501	851179304700	FOKO MP3/KT 0,47UF20% 275V
C 62502	851179304700	FOKO MP3/KT 0,47UF20% 275V
C 62521	866009823400	KERKO SI 1000PF 20% 400V
C 62548	866009823800	KERKO SI 2200PF 20% 400V
C 62549	866009823400	KERKO SI 1000PF 20% 400V
C 64006	851591160900	FOKO FKP1 180PF -5% 2000V
CD 21636	833050414800	MELF DIODE MCL4148
CD 21666	833050414800	MELF DIODE MCL4148
CD 40536	833050414800	MELF DIODE MCL4148
CD 52503	833050414800	MELF DIODE MCL4148
CD 53519	833050414800	MELF DIODE MCL4148
CD 55503	830945504400	MELF Z-DIODE 4,3B 0,5W
CD 55504	833050414800	MELF DIODE MCL4148
CD 57501	833050414800	MELF DIODE MCL4148
CD 57503	833050414800	MELF DIODE MCL4148
CD 57504	833050414800	MELF DIODE MCL4148
CD 57506	830945515000	MELF Z-DIODE 15VB 0,5W
CD 58501	833050414800	MELF DIODE MCL4148
CD 58504	833050414800	MELF DIODE MCL4148
CD 58507	830945502800	MELF Z-DIODE 2,7B 0,5W
CD 58511	833050414800	MELF DIODE MCL4148
CD 58512	833050414800	MELF DIODE MCL4148
CD 58521	833050414800	MELF DIODE MCL4148
CD 58522	833050414800	MELF DIODE MCL4148
CD 60811	833010130200	MELF DIODE BAV 302
CD 60812	832561034100	SMD DIODE STPS340U
CD 61528	832538430100	SMD Z-DIODE BZX84B30
CD 61538	832561034100	SMD DIODE STPS340U
CD 61548	832561034100	SMD DIODE STPS340U
CD 61558	832561034100	SMD DIODE STPS340U
CD 70501	830945505100	MELF Z-DIODE 5,1C 0,5W
CD 85513	830945505200	MELF-Z DIODE 5,1B 0,5W
CIC 21660	830598600000	SMD IC 74LV00
CL 60504	810498233100	SMD DAEMPF-PERLE
CT 21635	830100685800	SMD TRANS BC858C/BC857C
CT 21650	830100684800	SMD TRANS BC848C/BC847C
CT 21658	830100684800	SMD TRANS BC848C/BC847C
CT 21670	830100484800	SMD TRANS BC848B/BC847B
CT 40531	830100484800	SMD TRANS BC848B/BC847B
CT 40591	830100484800	SMD TRANS BC848B/BC847B
CT 44515	830100484800	SMD TRANS BC848B/BC847B
CT 57506	830100484800	SMD TRANS BC848B/BC847B
CT 58512	830100484800	SMD TRANS BC848B/BC847B
CT 60806	830100685800	SMD TRANS BC858C/BC857C
CT 61585	830100484800	SMD TRANS BC848B/BC847B
CT 85505	830100385800	SMD TRANS BC858B/BC857B
CT 85510	830100385800	SMD TRANS BC858B/BC857B
D 21512	830921502000	DIODE 1N4004
D 21621	830921504500	DIODE 1N4148
D 21622	830921504500	DIODE 1N4148
D 40532	830921504500	DIODE 1N4148
D 50513	830951627200	DIODE BYV27/200
D 52506	830921502000	DIODE 1N4004
D 53508	830920100500	DIODE BA157
D 53519	830970900300	Z-DIODE ZV51
D 53571	830920435900	DIODE BY359 1500
D 53572	830920423000	DIODE BY229-600
D 54501	830920100500	DIODE BA157
D 54511	830920100500	DIODE BA157
D 55512	830972033300	Z DIODE 33C 0,5W

POS. NR. POS. NO.	MATERIAL-NR. PART NUMBER	BEZEICHNUNG DESCRIPTION
D 60019	830919780600	DIODE STTA806DI
WW.	830919780700	DIODE STTA806DI
D 60021	830919780600	DIODE STTA806DI
WW.	830919780700	DIODE STTA806DI
D 60509	830921140600	DIODE SF4006
D 60512	830951675400	DIODE BY753B
D 60523	830856038400	GLR.SKB380C1500
D 61503	830972009900	Z DIODE 10B 0,5W
D 61511	830951603800	DIODE BYV38
D 61512	830951603800	DIODE BYV38
D 61516	830951679800	DIODE BYT08 P-1000
D 61521	830919682000	DIODE STPR820D
D 61524	830919682000	DIODE STPR820D
D 61533	830920100500	DIODE BA157
D 61561	830951717200	DIODE BYW172D
D 61566	830951717200	DIODE BYW172D
D 64010	830966306800	Z-DIODE BZT03D68
D 64011	830920002100	DIODE BAV21
D 64012	830920002100	DIODE BAV21
D 64013	830920002100	DIODE BAV21
D 64014	830920002100	DIODE BAV21
D 64211	830971411200	Z-DIODE 12C 1,3W
D 64212	830971411200	Z-DIODE 12C 1,3W
D 64223	830972002500	Z DIODE 2,4B 0,5W
D 64263	830921502000	DIODE 1N4004
D 64264	830921502000	DIODE 1N4004
D 64268	830921502000	DIODE 1N4004
D 64289	830921502000	DIODE 1N4004
D 85501	830998411600	LE-DIODE L-115WEGW
FS 64001	293032300200	FUNKENSTRECKE 1,6KV
IC 40510	830536729700	IC TDA7297
IC 50510	830512597900	IC STV9379A
IC 55510	830533814500	IC TDA8145
IC 58510	830520439300	IC LM393P
IC 60510	830533464700	IC TDA16846-2
IC 60801	830547026400	IC TNY264
IC 60817	830546543100	IC TS4311Z-AP
IC 61510	830520435700	IC LM358N
IC 61535	830520497800	IC L4978
IC 61545	830520497800	IC L4978
IC 61555	830520497800	IC L4978
IC 64220	830520435700	IC LM358N
IC 84501	830546123600	IC TSOP1236
L 53501	810498205600	FERRITPERLE HF70 BTL 3,5X
L 53502	810498205600	FERRITPERLE HF70 BTL 3,5X
L 53503	810498205600	FERRITPERLE HF70 BTL 3,5X
L 53511	814050524900	DR A AX-GA 10UH 10%
L 53512	092401144040	DROSSEL 1,5 MH CHOKE
L 53521	292031229500	LINEARITAETSREGLER
WW.	292031229700	LINEARITAETSREGLER
L 53574	092468596601	BRUECKENSPULE M.KERN BRIDGECOIL W.CORE
L 55514	092458160100	O/W AUSKOPPELSPULE E/W COUPLING COIL
L 60506	810498208100	FERRITPERLE 0,676UH
L 60507	810498208000	FERRITPERLE 0,676UH
L 60518	810498208000	FERRITPERLE 0,676UH
L 60528	292017119700	FERRITE BEAD SPEICHERDROSSEL
L 60812	814052499200	STORAGE CHOKE SIEB-DR 10UH 15%
L 61511	810498201400	FILTER CHOKE DAEMPF-PERLE 433003038102
L 61514	810498201400	FILTER CHOKE DAEMPF-PERLE 433003038102

ÄNDERUNGEN VORBEHALTEN / SUBJECT TO ALTERATION

POS. NR. POS. NO.	MATERIAL-NR. PART NUMBER	BEZEICHNUNG DESCRIPTION
L 61521	810498201400	DAEMPF-PERLE 433003038102
L 61524	810498201400	DAEMPF-PERLE 433003038102
L 61527	814052499200	DAMPING BEAD
L 61538	814052499500	SIEB-DR 10UH 15% SIEB-DR 330UH FILTER CHOKE
L 61548	814052105900	SPEICHER-DR 59UH 2,5A
L 61548	814052106800	SPEICHER-DR 67UH STORAGE CHOKE
L 61549	814052499200	SIEB-DR 10UH 15% FILTER CHOKE
L 61558	814052106700	SPEICHER-DR EF16 67UH
L 61558	814052105900	SPEICHER-DR 59UH 2,5A
L 61558	814052106800	SPEICHER-DR 67UH STORAGE CHOKE
L 61561	810498201400	DAEMPF-PERLE 433003038102
L 61562	814050506500	DAMPING BEAD DR A AX-GA 47UH 5% CHOKE
L 61566	810498201400	DAEMPF-PERLE 433003038102
L 61567	814050506500	DAMPING BEAD DR A AX-GA 47UH 5% CHOKE
L 62501	295008359700	ENTSTOER-DR 2X22MH
L 64229	814052495000	ENTSTOER-DR 2X470UH B8279
L 64290	814052495000	ENTSTOER-DR 2X470UH B8279 INTERFERENCE CHOKE
OK 22505	830600036200	OPTOKOPPLER
WW.	830600024200	OPTOKOPPLER
OK 60531	830600001200	OPTOKOPPLER
OK 60546	830600001200	OPTOKOPPLER
OK 60805	830600061500	OPTOKOPPLER OPTO COUPLER
R 21512	870000754900	KSW 0207 1,5 MOHM 5%
R 21523	870532122100	MOW 0411 6,8 OHM 5%
R 22501	831120001800	PTC DUO B59709-T60-A110
R 22504	870004912100	KSW 0411 100 KOHM 5%
R 22506	870022905700	KSW NB 0207 220 OHM 5%
R 40502	873229600900	DRW 6,5 2,2 OHM 10%
R 50507	876642460800	MSW 0207 2 OHM 1%
R 50508	876642460800	MSW 0207 2 OHM 1%
R 50526	870042900500	KSW NB 0207 1,5 OHM 5%
R 50529	876635705200	MSW 0414 130 OHM 5%
R 52501	870532901700	MOW 0411 4,7 OHM 5%
R 52503	873023923900	DRW SI S77 3W 39 OHM 5%
R 52505	870536000800	MOW 0617 3,9 OHM 5%
R 52506	870536000800	MOW 0617 3,9 OHM 5%
R 53508	870042909700	KSW NB 0207 10 KOHM 5%
R 53511	870522702100	MOW 0411 6,8 OHM 5%
R 53516	873028002100	DRW SI S11 7W 6,8 OHM 5%
R 53521	870536906300	MOW 0617 390 OHM 5%
R 54501	873500303300	DRW 0,75W 0,33 OHM 10%
R 54511	873500303300	DRW 0,75W 0,33 OHM 10%
R 55512	870536906500	MOW 0617 470 OHM 5%
R 55514	870123081700	NKS 3 4,7 OHM 5%
R 58501	876519810400	MSW 0207 20 KOHM 1%
R 58502	876519808600	MSW 0207 3,6 KOHM 1%
R 58524	870001134500	KSW 0204 1 MOHM 5%
R 60502	870006935600	KSW 0617 3 MOHM 2%
R 60504	870006934100	KSW 0617 680 KOHM 2%
R 60508	873018970100	DRW 9 15 KOHM 10%
R 60512	870000743200	KSW 0207 20 OHM 5%
R 60801	876521212700	MSW 0411 180 KOHM 5%
R 60802	831140107400	VDR SIOV-S07K385G53

Es gelten die Vorschriften und Sicherheitshinweise gemäß dem Service Manual "Sicherheit", Mat.-Nummer 720108000000, sowie zusätzlich die eventuell abweichenden, landesspezifischen Vorschriften!



The regulations and safety instructions shall be valid as provided by the "Safety" Service Manual, part number 720108000000, as well as the respective national deviations.

ÄNDERUNGEN VORBEHALTEN / SUBJECT TO ALTERATION







Ersatzteilliste
Spare Parts List

TV

9 / 2002

CHASSIS-FS-STEREO DIGI 100 CUC 1935
CHASSIS TV STEREO DIGI 100 CUC 1935

MATERIAL-NR. / PART NO.: 297040193300

Table with columns: POS. NR., ABB. FIG., MATERIAL-NR., ANZ., BEZEICHNUNG, DESCRIPTION. Lists parts for CHASSIS-FS-STEREO DIGI 100 CUC 1935.

203

X = SIEHE GESONDERTE E-LISTE
WW. = WAHLWEISE

Table with columns: POS. NR., MATERIAL-NR., BEZEICHNUNG. Lists additional parts for various components like ELKO and KERKO.

ÄNDERUNGEN VORBEHALTEN / SUBJECT TO ALTERATION

Table with columns: POS. NR., MATERIAL-NR., BEZEICHNUNG. Lists parts for MELF DIODE MCL4148 and other diode-related components.

Table with columns: POS. NR., MATERIAL-NR., BEZEICHNUNG. Lists parts for DIODE BA157, DIODE BYW172D, and other diode-related components.

ÄNDERUNGEN VORBEHALTEN / SUBJECT TO ALTERATION



Table with columns: POS. NR., MATERIAL-NR., BEZEICHNUNG. Contains electronic component part numbers and descriptions.

Table with columns: POS. NR., MATERIAL-NR., BEZEICHNUNG. Contains electronic component part numbers and descriptions.

Table with columns: POS. NR., MATERIAL-NR., BEZEICHNUNG. Contains electronic component part numbers and descriptions.

Table with columns: POS. NR., MATERIAL-NR., BEZEICHNUNG. Contains electronic component part numbers and descriptions.

ÄNDERUNGEN VORBEHALTEN / SUBJECT TO ALTERATION

Es gelten die Vorschriften und Sicherheitshinweise gemäß dem Service Manual "Sicherheit"...



The regulations and safety instructions shall be valid as provided by the "Safety" Service Manual...

ÄNDERUNGEN VORBEHALTEN / SUBJECT TO ALTERATION





Table with 4 columns: POS. NR., MATERIAL-NR., BEZEICHNUNG, and POS. NR., MATERIAL-NR., BEZEICHNUNG. It lists various electronic components like diodes, capacitors, and transformers with their part numbers and descriptions.

ÄNDERUNGEN VORBEHALTEN / SUBJECT TO ALTERATION

Es gelten die Vorschriften und Sicherheitshinweise gemäß dem Service Manual "Sicherheit", Mat.-Nummer 720108000000, sowie zusätzlich die eventuell abweichenden, landesspezifischen Vorschriften! The regulations and safety instructions shall be valid as provided by the "Safety" Service Manual, part number 720108000000, as well as the respective national deviations.



ÄNDERUNGEN VORBEHALTEN / SUBJECT TO ALTERATION





POS. NR. POS. NO.	MATERIAL-NR. PART NUMBER	BEZEICHNUNG DESCRIPTION
CD 57501	833050414800	MELF DIODE MCL4148
CD 57503	833050414800	MELF DIODE MCL4148
CD 57504	833050414800	MELF DIODE MCL4148
CD 57506	830945515000	MELF Z-DIODE 15V B 0,5W
CD 58501	833050414800	MELF DIODE MCL4148
CD 58504	833050414800	MELF DIODE MCL4148
CD 58507	830945502800	MELF Z-DIODE 2,7 B 0,5W
CD 58511	833050414800	MELF DIODE MCL4148
CD 58512	833050414800	MELF DIODE MCL4148
CD 58521	833050414800	MELF DIODE MCL4148
CD 58522	833050414800	MELF DIODE MCL4148
CD 60811	833010130200	MELF DIODE BAV 302
CD 60812	832561034100	SMD DIODE STPS340U
CD 61528	832538430100	SMD Z-DIODE BZX84B30
CD 61538	832561034100	SMD DIODE STPS340U
CD 61548	832561034100	SMD DIODE STPS340U
CD 61558	832561034100	SMD DIODE STPS340U
CD 70501	830945505100	MELF-Z DIODE 5,1 C 0,5W
CD 85513	830945505200	MELF-Z DIODE 5,1 B 0,5W
CIC 21660	830598600000	SMD IC 74LV00
CL 60504	810498233100	SMD DAEMPF-PERLE 0805
CT 21635	830100685800	SMD TRANS BC858C/ BC857C
CT 21650	830100684800	SMD TRANS BC848C/ BC847C
CT 21658	830100684800	SMD TRANS BC848C/ BC847C
CT 21670	830100484800	SMD TRANS BC848B/ BC847B
CT 40531	830100484800	SMD TRANS BC848B/ BC847B
CT 40591	830100484800	SMD TRANS BC848B/ BC847B
CT 44515	830100484800	SMD TRANS BC848B/ BC847B
CT 57506	830100484800	SMD TRANS BC848B/ BC847B
CT 58512	830100484800	SMD TRANS BC848B/ BC847B
CT 60806	830100685800	SMD TRANS BC858C/ BC857C
CT 61585	830100484800	SMD TRANS BC848B/ BC847B
CT 85505	830100385800	SMD TRANS BC858B/ BC857B
CT 85510	830100385800	SMD TRANS BC858B/ BC857B
D 21512	830921502000	DIODE 1N4004
D 21621	830921504500	DIODE 1N4148
D 21622	830921504500	DIODE 1N4148
D 40532	830921504500	DIODE 1N4148
D 50513	830951627200	DIODE BYV27/200
D 52506	830921502000	DIODE 1N4004
D 53508	830920100500	DIODE BA157
D 53519	830970900300	Z DIODE ZY 51
D 53571	830920435900	DIODE BY359 1500
D 53572	830920423000	DIODE BY 229-600
D 54501	830920100500	DIODE BA157
D 54511	830920100500	DIODE BA157
D 55512	830972033300	Z DIODE 33 C 0,5W
D 60019	830919780700	DIODE STTA806D
D 60021	830919780700	DIODE STTA806D
D 60509	830921140600	DIODE SF4006
D 60512	830951675400	DIODE BYT53B
D 60523	830856038400	GLR.SKB380C1500
D 61503	830972009900	Z DIODE 10 B 0,5W
D 61511	830951603800	DIODE BYV38
D 61512	830951603800	DIODE BYV38
D 61516	830951679800	DIODE BYT 08 P-1000
D 61521	830919612000	DIODE STPR1520D
D 61524	830919682000	DIODE STPR820D
D 61533	830920100500	DIODE BA157
D 61561	830951717200	DIODE BYW172D
D 61566	830951717200	DIODE BYW172D
D 64010	830966306800	Z-DIODE BZT03D68
D 64011	830920002100	DIODE BAV21
D 64012	830920002100	DIODE BAV21
D 64013	830920002100	DIODE BAV21
D 64014	830920002100	DIODE BAV21

POS. NR. POS. NO.	MATERIAL-NR. PART NUMBER	BEZEICHNUNG DESCRIPTION
D 64211	830971411200	Z-DIODE 12 C 1,3W
D 64212	830971411200	Z-DIODE 12 C 1,3W
D 64223	830972002500	Z DIODE 2,4 B 0,5W
FS 64001	293032300200	FUNKENSTRECKE 1,6KV
IC 40510	830536729700	IC TDA7297
IC 50510	830512597900	IC STV9379A
IC 55510	830533814500	IC TDA8145
IC 58510	830520439300	IC LM393P
IC 60510	830533464700	IC TDA16846-2
IC 60801	830547026400	IC TNY264
IC 60817	830546543100	IC TS4311Z-AP
IC 61510	830520435700	IC LM358N
IC 61535	830520497800	IC L4978
IC 61545	830520497800	IC L4978
IC 61555	830520497800	IC L4978
IC 64220	830520435700	IC LM358N
L 53501	810498205600	FERRITPERLE HF70 BTL 3,5X6
L 53502	810498205600	FERRITPERLE HF70 BTL 3,5X6
L 53503	810498205600	FERRITPERLE HF70 BTL 3,5X6
L 53511	814050524900	DR A AX-GA 10UH 10%
L 53512	092401144040	DROSSEL 1,5 MH/COIL 1,5 MH
L 53521	292031229500	LINEARITAETSREGLER
L 53521	292031229700	WW. LINEARITAETSREGLER
L 53574	092468596601	LINEARITY CONTROL
L 55514	092458160100	BRUECKENSPULE M.KERN BRIDGE COIL W. CORE
L 60506	810498208100	O/W AUSKOPPELSPULE
L 60507	810498208000	E/W DECOUPLING COIL
L 60518	810498208000	FERRITPERLE 0,676UH LI
L 60518	810498208000	FERRITPERLE 0,676UH
L 60518	810498208000	FERRITPERLE 0,676UH
L 60528	292017119700	FERRITE BEAD SPEICHERDROSSEL EF25/11 1,8MH STORAGE CHOKE EF25/11 1,8MH
L 60812	814052499200	SIEB-DR 10UH 15% FILTER CHOKE 10UH 15%
L 61511	810498201400	DAEMPF-PERLE 433003038102
L 61514	810498201400	DAEMPF-PERLE 433003038102
L 61521	810498201400	DAEMPF-PERLE 433003038102
L 61524	810498201400	DAEMPF-PERLE 433003038102
L 61527	814052499200	DAMPING BEAD SIEB-DR 10UH 15% FILTER CHOKE 10UH 15%
L 61538	814052499500	SIEB-DR 330UH FILTER CHOKE 330UH
L 61548	814052105900	SPEICHER-DR 59UH 2,5A STORAGE CHOKE 59UH 2,5A
L 61548	814052106800	SPEICHER-DR 67UH EF16 STORAGE CHOKE 67UH EF16
L 61549	814052499200	SIEB-DR 10UH 15% FILTER CHOKE 10UH 15%
L 61558	814052105900	SPEICHER-DR 59UH 2,5A STORAGE CHOKE 59UH 2,5A
L 61558	814052106700	WW. SPEICHER-DR EF16 67UH 2,5A STORAGE CHOKE EF16 67UH 2,5A
L 61558	814052106800	WW. SPEICHER-DR 67UH EF16 STORAGE CHOKE 67UH EF16
L 61561	810498201400	DAEMPF-PERLE 433003038102 DAMPING BEAD
L 61562	814050506500	DR A AX-GA 47UH 5%
L 61566	810498201400	DAEMPF-PERLE 433003038102 DAMPING BEAD
L 61567	814050506500	DR A AX-GA 47UH 5%
L 62501	295008359700	ENTSTOER-DR 2X22MH INTERFERENCE CHOKE 2X22MH
L 64229	814052495000	ENTSTOER-DR 2X470UH INTERFERENCE CHOKE 2X470MH

ÄNDERUNGEN VORBEHALTEN / SUBJECT TO ALTERATION

POS. NR. POS. NO.	MATERIAL-NR. PART NUMBER	BEZEICHNUNG DESCRIPTION
OK 22505	830600036200	OPTOKOPPLER TLP3063
OK 22505	830600024200	WW. OPTOKOPPLER IL4216-X001
OK 60531	830600001200	OPTOKOPPLER CNY17F1
OK 60546	830600001200	OPTOKOPPLER CNY17F1
OK 60805	830600061500	OPTOKOPPLER SFH615A-2
R 21523	870532122100	MOW 0411 6,8 OHM 5%
R 22501	831120001800	PTC DUO B59709-T60-A110
R 22504	870004912100	KSW 0411 100 KOHM 5%
R 22506	870022905700	KSW NB 0207 220 OHM 5%
R 40502	873229600000	DRW 6,5 0,56 OHM 10%
R 50507	876642460900	MSW 0207 2,2 OHM 1%
R 50508	876642460900	MSW 0207 2,2 OHM 1%
R 50526	870042900500	KSW NB 0207 1,5 OHM 5%
R 50529	876635705200	MSW 0414 130 OHM 5%
R 52501	870532901700	MOW 0411 4,7 OHM 5%
R 52503	873023923900	DRW SI S17 3W 39 OHM 5%
R 52505	870536000800	MOW 0617 3,9 OHM 5%
R 52506	870536000800	MOW 0617 3,9 OHM 5%
R 53508	870042909700	KSW NB 0207 10 KOHM 5% ST
R 53511	870522702100	MOW 0411 6,8 OHM 5%
R 53516	873028002100	DRW SI S11 7W 6,8 OHM 5%
R 53521	870536906300	MOW 0617 390 OHM 5% LI
R 54501	873500303300	DRW 0,75W 0,33 OHM 10%
R 54511	873500303300	DRW 0,75W 0,33 OHM 10%
R 55512	870536906500	MOW 0617 470 OHM 5% LI
R 55514	870123081700	NKS 3 4,7 OHM 5%
R 58501	876519810400	MSW 0207 20 KOHM 1%
R 58502	876519808600	MSW 0207 3,6 KOHM 1%
R 60502	870006935600	KSW 0617 3 MOHM 2%
R 60504	870006934100	KSW 0617 680 KOHM 2%
R 60508	873018970100	DRW 9 15 KOHM 10%
R 60512	870000743200	KSW 0207 20 OHM 5%
R 60801	876521212700	MSW 0411 180 KOHM 5%
R 60802	831140107400	VDR SIOV-S07K385GS3
R 60803	870042904500	KSW NB 0207 68 OHM 5%
R 60806	876504915300	MSW SI 0414 2,2 MOHM VDE
R 61508	879005005400	ESTR.SK10-A 22 KOHM LIN
R 61512	870042904900	KSW NB 0207 100 OHM 5% ST
R 61518	870522732100	MOW 0411 100 KOHM 10%
R 61527	870536930100	MOW 0617 15 KOHM 10% LI
R 61533	873506404900	DRW 4 100 OHM 5%
R 62501	876504914500	MSW SI 0414 1 MOHM 5% VDE
R 62502	831100501700	NTC 4,7 OHM 30%
R 62503	831140127500	VDR SIOV-S14K275E2S11M5
R 62549	876634915500	MSW SI 0414 2,7 MOHM 5% LI
R 64211	870111903500	KSW SI B 27 OHM 5% ST
R 64212	870111903500	KSW SI B 27 OHM 5% ST
R 64241	870001131000	KSW 0204 36 KOHM 5%
SI 52501	831561202700	SI LOET T315MA 250V
SI 60501	831562000300	SI 5X20 T2A L 250V
SI 61521	831562300800	SI LOET T4A 250V
SI 61524	831562102700	SI LOET T2,5A 250V
SI 61538	831561820000	SI LOET T1A 250V
SI 61561	831562022500	SI LOET T2A 250V
SI 61566	831562022500	SI LOET T2A 250V
SI 62501	831562250300	SI 5X20 T3,15A H 250V
T 50528	830221054400	TRANS BD544B/ BD538
T 50529	830221054300	TRANS BD543B/ BD537
T 52503	830221068200	TRANS.BD 679A
T 53501	830262533100	TRANS 2SC5331
T 60506	830263829800	TRANS 2SK2699
T 64016	830328763900	TRANS.BC 639
T 64110	830320554800	TRANS BC548B/ BC547B

Es gelten die Vorschriften und Sicherheitshinweise gemäß dem Service Manual "Sicherheit", Mat.-Nummer 720108000000, sowie zusätzlich die eventuell abweichenden, landesspezifischen Vorschriften!



The regulations and safety instructions shall be valid as provided by the "Safety" Service Manual, part number 720108000000, as well as the respective national deviations.

ÄNDERUNGEN VORBEHALTEN / SUBJECT TO ALTERATION

Ersatzteilliste Spare Parts List

7 / 2002

CHASSIS-FS-STEREO DIGI 100 CUC 1935 CHASSIS TV STEREO DIGI 100 CUC 1935

MATERIAL-NR. / PART NO.: 297040196900

Main parts list table with columns: POS. NR., ABB. FIG., MATERIAL-NR., ANZ., BEZEICHNUNG, DESCRIPTION. Includes items like CHASSIS-FS-STEREO DIGI 100 CUC 1935 KEIN E-TEIL, BAUSTEIN SIGNAL/ZF+TUNER, and DYN.FOKUSSIERUNGSPLATTE.

Continuation of parts list table with columns: POS. NR., MATERIAL-NR., BEZEICHNUNG, POS. NR., MATERIAL-NR., BEZEICHNUNG. Includes items like ELKO 2200UF 20% 25V, KERKO HV C 100PF 20% 1KV, and FOKO FKP1 142PF 2.5% 2000V.

ÄNDERUNGEN VORBEHALTEN / SUBJECT TO ALTERATION

Table of electronic components with columns: POS. NR., MATERIAL-NR., BEZEICHNUNG, POS. NO., PART NUMBER, DESCRIPTION. Includes items like KERKO HV C 1000PF 20% 1KV, FOKO FKP1 100PF 10% 1600V, and MELF DIODE MCL4148.

Table of electronic components with columns: POS. NR., MATERIAL-NR., BEZEICHNUNG, POS. NO., PART NUMBER, DESCRIPTION. Includes items like DIODE BA157, DIODE Z-DIODE ZY51, and DIODE BY359 1500.

ÄNDERUNGEN VORBEHALTEN / SUBJECT TO ALTERATION



