

DVD

Service Manual

2. Ergänzung / Supplement 2



XENARO

GDP 5100	GMI8600
GDP 5100 /1	GMI6100
GDP 5100 /2	GMI8700
GDP 5102	GMI8900
GDP 5105	GMI9700
GDP 5120	GMI9200
GDP 6150 /1	GMI6000
GDP 6150 /2	GMI9300
GDP 6155	GMI9600

MALAGA

SE 1230	GMI6200
SE 1235	GMI9900

Zusätzlich erforderliche Unterlagen für den Komplettservice
 Additionally required Service Documents for the Complete Service

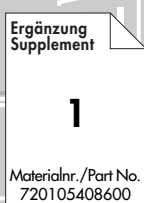

Grundig Service

Hotline Deutschland...
 ...Mo.-Fr. 8.00-18.00 Uhr

<i>Technik:</i>	
TV	0180/52318-41
TV	0180/52318-49
SAT	0180/52318-48
VCR/LiveCam	0180/52318-42
HiFi/Audio	0180/52318-43
Car Audio	0180/52318-44
Telekommunikation	0180/52318-45
Fax:	0180/52318-51
Planatron (8.00-22.00 Uhr)	0180/52318-99
<i>Ersatzteil-Verkauf: Mo.-Fr. 8.00-19.00 Uhr</i>	
Telefon:	0180/52318-40
Fax:	0180/52318-50
<i>Kundendienst/Werkstätten: Mo.-Fr. 8.00-18.00 Uhr</i>	
Telefon:	0180/52318-52
Fax:	0180/52318-46
gebührenpflichtig	

Materialnummer/Part Number 720105408700

Änderungen vorbehalten/Subject to alteration • Printed in Germany IP

H-S41 0202

<http://www.grundig.com>

Es gelten die Vorschriften und Sicherheitshinweise gemäß dem Service Manual "Sicherheit", Materialnummer 720108000000, sowie zusätzlich die eventuell abweichenden, landesspezifischen Vorschriften!



The regulations and safety instructions shall be valid as provided by the "Safety" Service Manual, part number 720108000000, as well as the respective national deviations.

Inhaltsverzeichnis

	Seite
Allgemeiner Teil	2...6
Einführung	2
Geräteübersicht	3
Ausbauhinweise	4
Platinenabbildungen und Schaltpläne	7...14
Laufwerk-Platte "KIT 510 LE"	7
Explosionszeichnung und Ersatzteillisten	15...22

Table of Contents

	Page
General Section	2...6
Introduction	2
DVD Overview	3
Disassembly Instructions	4
Layout of PCBs and Circuit Diagrams	7...14
Drive Board "KIT 510 LE"	7
Exploded View and Spare Parts Lists	15...22

Allgemeiner Teil

Einführung

In dieser Service-Manual-Ergänzung sind die Geräte GDP5105, GDP6155 und SE1235 der Serie Xenaro GDP51.../6150 dokumentiert. Des Weiteren enthält diese für die gesamte Serie Xenaro die geänderten Ausbauhinweise sowie die Schaltpläne und Platinenabbildungen des Laufwerkes KIT 510 LE. Nähere Informationen entnehmen Sie bitte der Geräteübersicht.

Hinweis:

- Grundlage für den Service sind folgende Service Manuals:
- Service Manual Sicherheit, Materialnummer 720108000000
 - Service Manual GDP51.../6150, Materialnummer 720105408500
 - Ergänzung GDP51.../6150, Materialnummer 720105408600

General Section

Introduction

This Supplement Service Manual describes the DVD players GDP5105, GDP6155 und SE1235 in the series Xenaro GDP51.../6150. In addition this includes for the entire Xenario series the changed disassembly instructions as well as the circuit diagrams and board layouts of the drive unit KIT 510 LE. For detailed information please see chapter DVD Overview.

Note:

- Basic instructions for servicing are given in the following Service Manuals:
- Service Manual Safety, Part Number 720108000000
 - Service Manual GDP51.../6150, Part Number 720105408500
 - Supplement GDP51.../6150, Part Number 720105408600

"Dolby", "Dolby Pro Logic", "AC 3" ist gefertigt unter Lizenz von Dolby Laboratories Licensing Corporation.
"Dolby", "Dolby Pro Logic", "AC 3" und das Doppel-D-Symbol  sind Warenzeichen der Dolby Laboratories Licensing Corporation. Copyright 1992 Dolby Laboratories, Inc. Alle Rechte vorbehalten.

"Dolby", "Dolby Pro Logic", "AC 3" manufactured under license from Dolby Laboratories Licensing Corporation.
"Dolby", "Dolby Pro Logic", "AC 3" and the double-D symbol  are trademarks of the Dolby Laboratories Licensing Corporation. Copyright 1992 Dolby Laboratories, Inc. All rights reserved.

Geräteübersicht / DVD Overview

	Service Manual Materialnr./Part No. 720105408500	1. Ergänzung Supplement 1 Materialnr./Part No. 720105408600	2. Ergänzung Supplement 2 Materialnr./Part No. 720105408700		GDP 5100	GDP 5100/1	GDP 5100/2	GDP 5102	GDP 5105	GDP 5120	GDP 6150/1	GDP 6150/2	GDP 6155	SE 1230	SE 1235	
Bausteintübersicht / Table of Modules	S./P. 3-10			Netzteil / Power Supply	●	●	●	●	●	●	●	●	●	●	●	
	S./P. 3-12 S./P. 3-15 S./P. 3-17 S./P. 3-19 S./P. 3-19 S./P. 3-20 S./P. 3-21	S./P. 4		Digital-Platte / Board • Hauptschaltplan / Main Circuit Diagram (P1) • Audio/Interface (P2) • Frontend (P3) • SDRAM (P4) • FLASH (P5) • Interface (P6)	●	●	●	●	●	●	●	●	●	●	●	
	S./P. 3-22			Analog-Platte / Board	●	●	●	●	●					●	●	
		S./P. 5 S./P. 7 S./P. 9		Analog-Platte / Board • AC3 • Audio/Video						●	●	●	●			
		S./P. 11		Bedieneinheit / Keyboard Control	●	●	●	●	●	●	●	●	●	●	●	●
	S./P. 3-35			Laufwerk-Platte / Drive Board "KIT 310 LE"	*1	*1	*1	*1		*1	*1	*1		*1		
			S./P. 7	Laufwerk-Platte / Drive Board "KIT 510 LE"	*1	*1	*1	*1	●	*1	*1	*1	●	*1	●	
Feature-Übersicht / Table of Features	DVD-Video				●	●	●	●	●	●	●	●	●	●	●	
	DVD-R (für Authoring / for authoring use)				●	●	●	●	●	●	●	●	●	●	●	
	Audio-CD				●	●	●	●	●	●	●	●	●	●	●	
	CD-R				●	●	●	●	●	●	●	●	●	●	●	
	CD-RW				●	●	●	●	●	●	●	●	●	●	●	
	Video-CD				●	●	●	●	●	●	●	●	●	●	●	
	S-VCD				●	●	●	●	●	●	●	●	●	●	●	
	MP3-CD				●	●	●	●	●	●	●	●	●	●	●	
	2 Laser (DVD / CD)				●	●	●	●	●	●	●	●	●	●	●	
	PAL-Wiedergabe / Playback				●	●	●	●	●	●	●	●	●	●	●	
	NTSC-Wiedergabe / Playback				●	●	●	●	●	●	●	●	●	●	●	
	Konverter / Converter (PAL-NTSC / NTSC-PAL)				●	●	●	●	●	●	●	●	●	●	●	
	OSD				●	●	●	●	●	●	●	●	●	●	●	
	Bildschirmschoner / Screen Saver				●	●	●	●	●	●	●	●	●	●	●	
	Virtual Surround Sound				●	●	●	●	●	●	●	●	●	●	●	
	Digital-Audio-Decoder (AC3, MPEG2)				●	●	●	●	●	●	●	●	●	●	●	
	Digital-Audio-Decoder (DTS)									●	●	●	●			
	Kindersicherung / Child Lock				●	●	●	●	●	●	●	●	●	●	●	
	Digital Sound Processing									●	●	●	●	●	●	
	Dauerlauf-Wiedergabe / Continuous Playback				●	●	●	●	●	●	●	●	●	●	●	
	EURO-AV-Buchse / Socket TV				●	●	●	●	●	●	●	●	●	●	●	
	EURO-AV-Buchse / Socket Video									●	●	●	●			
	Data-Link (IR-Fernbedienung – EURO-AV-Kontakt 8 / IR Remote – EURO-AV contact 8)				●	●	●	●	●	●	●	●	●	●	●	
	S-Video-Ausgang / Output				●	●	●	●	●	●	●	●	●	●	●	
	Digital-Audio-Ausgang optisch / Digital Audio Output optical (AC3 / MPEG2 / DTS / PCM)									●	●	●	●			
	Digital-Audio-Ausgang koaxial / Digital Audio Output coaxial (AC3 / MPEG2 / DTS / PCM)				●	●	●	●	●	●	●	●	●	●	●	
	LINE-Ausgangs-Buchsen / Output Sockets				●	●	●	●	●	●	●	●	●	●	●	
Subwoofer-Ausgangs-Buchse / Output Socket									●	*2	*2	*2				
5.1 Audio-Ausgangs-Buchsen / Output Sockets										●	●	●				
Kopfhörerbuchse / Headphone Socket 3.5mm										●	●	●				
Jog / Shuttle										●	●	●				
Energiesparend / Low Power (Standby <0.2W)										●	●	●				
Energiesparend / Low Power (Standby <5W)				●	●	●	●	●					●	●		

*1 wahlweise bestückt (Erkennungsmerkmale: siehe Seite 5, Fig. 7...10) / optionally equipped (identification marks: see page 5, Fig. 7...10)

*2 Bestandteil der 5.1 Audio-Ausgangs-Buchsen / part of 5.1 audio output sockets

Ausbauhinweise

Vor dem Öffnen des Gerätes Netzstecker ziehen

1. DVD/CD aus defektem Laufwerk entfernen

- Gehäuseoberteil abnehmen (Punkt 2).
- Mit einem dünnen Schraubendreher durch das Loch ③ (Fig. 11) den Schieber ca. 2cm nach innen schieben und Schublade herausziehen.

2. Gehäuseoberteil

- 3 Schrauben ① (Fig. 2) herausdrehen.
- Gehäuseoberteil nach hinten schieben und abnehmen.

Montagehinweis:

- Gehäuseoberteil über der Rastnase ④ (Fig. 1) aufsetzen.
- Gehäuseoberteil im Bereich der Rastnase und an den Seitenteilen vorsichtig zusammendrücken und in die Frontblende schieben.

3. Frontblende

- Schublade öffnen (bei defektem Laufwerk siehe Punkt 1), 2 Rastnasen ⑤ (Fig. 5) lösen und Schubladenblende abnehmen.
- 2 Schrauben ⑥ (Fig. 1) herausdrehen.
- 6 Rastnasen ⑦ / ⑧ lösen und Frontblende abnehmen.
- Gegebenenfalls Steckverbindung lösen.

4. Bedieneinheiten

- Frontblende abnehmen (Punkt 3).
- 6 Schrauben ⑨ (Fig. 4) herausdrehen.
- Rastnasen ⑩ (Fig. 4) lösen.
- Bedieneinheiten aus der Frontblende nehmen.
- Gegebenenfalls Steckverbindung lösen.

5. Analog-Platte

- Schrauben ⑪ (Fig. 2 / 3) und Schraube ⑫ herausdrehen.
- Rastnasen an beiden Seiten ausrasten und Rückwand abnehmen.
- Schraube ⑬ (Fig. 1) herausdrehen.
- Analog-Platte herausnehmen.
- Gegebenenfalls Steckverbindungen lösen.

6. Netzteil

- 4 Schrauben ⑭ (Fig. 1) und Schraube ⑮ (Fig. 2 / 3) herausdrehen.
- Netzteil herausnehmen.
- Gegebenenfalls Steckverbindungen lösen.

7. Digital-Platte

- 3 Schrauben ⑯ (Fig. 1) und Schraube ⑰ herausdrehen.
- Digital-Platte herausnehmen.
- Gegebenenfalls Steckverbindungen lösen.

Achtung:

Nach dem Tausch der Digital-Platte, des EEPROM's (U7 / U71) oder des FLASH (U13 / U15) muss ein Software-Upgrade (Service Manual 720105408500, Seite 2-1) durchgeführt werden.

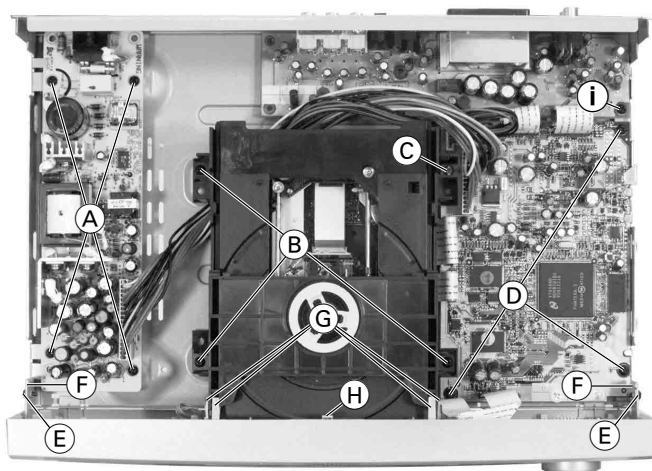

Fig. 1

Disassembly Instructions

Disconnect the mains plug before opening the set.

1. Opening the Tray when the Drive is Defective

- Remove the Cabinet Upper Part (Point 2).
- Insert a thin screw driver through the hole ③ (Fig. 11), push the slider about 2cm in inward direction then pull out the tray.

2. Cabinet Upper Part

- Undo the 3 screws ① (Fig. 2).
- Slide the upper part of the cabinet to the rear then remove it.

Reassembly hint:

- Place the upper part of the cabinet on the locking lug ④ (Fig. 1).
- Carefully press together the upper part of the cabinet in the area of the locking lug and the side parts then slide it into the front trim.

3. Front Trim

- Open the tray (with a defective drive mechanism, see Point 1), undo the 2 locking lugs ⑤ (Fig. 5) then remove the front trim of the tray.
- Undo the 2 screws ⑥ (Fig. 1).
- Undo the 6 locking lugs ⑦ / ⑧ then remove the front trim.
- Unplug the connector if necessary.

4. Keyboard Control Units

- Remove the front trim (Point 3).
- Undo the 6 screws ⑨ (Fig. 4).
- Undo the locking lugs ⑩ (Fig. 4).
- Remove the keyboard control units from the front trim.
- Unplug the connector if necessary.

5. Analog Board

- Undo the screws ⑪ (Fig. 2 / 3) and screw ⑫.
- Undo the locking lugs at the two sides then remove the rear panel.
- Undo the screw ⑬ (Fig. 1).
- Remove the analog board.
- Unplug the connectors if necessary.

6. Power Supply

- Undo the 4 lugs ⑭ (Fig. 1) and the screw ⑮ (Fig. 2 / 3).
- Remove the power supply from the unit.
- Unplug the connectors if necessary.

7. Digital Board

- Undo the 3 screws ⑯ (Fig. 1) and the screw ⑰ (Fig. 1).
- Remove the digital board.
- Unplug the connectors if necessary.

Attention:

After replacing the digital board, the EEPROM (U7 / U71), or the FLASH (U13 / U15) a software upgrade must be carried out (Service Manual 720105408500, page 2-3).

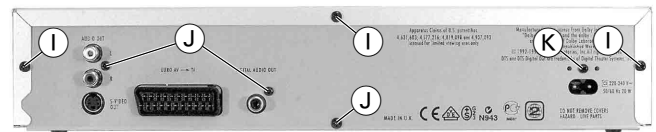

Fig. 2

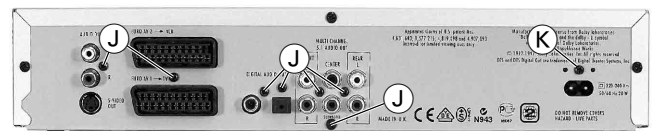

Fig. 3

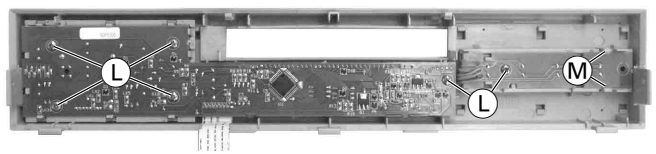

Fig. 4

8. Laufwerkeinheit

- Frontblende abnehmen (Punkt 3).
- 3 Schrauben **(B)** (Fig. 1) und Schraube **(C)** herausdrehen.
- Laufwerkeinheit nach links schieben und herausnehmen.
- Gegebenenfalls Steckverbindungen lösen.

Montagehinweis

- Die Digital-Platte muss sich bei der Montage über den Füßen der Laufwerkeinheit befinden.

9. Laufwerkeinheit zerlegen

- Laufwerkeinheit ausbauen (Punkt 8).

9.1 Laufwerk-Platte ausbauen

- Schrauben **(O)** (Fig. 7/8) herausdrehen und Laufwerk-Platte abnehmen.

- Gegebenenfalls Steckverbindungen lösen.
- Achtung:** Die Lasereinheit ist sehr empfindlich gegen statische Aufladungen (MOS-Bauteile)!

Schließen Sie deshalb die Flexprintleitung zur Lasereinheit **vor dem Lösen der Steckverbindung** mit einer Büroklammer kurz oder bringen Sie die Schutzlötstellen **(P)** (Fig. 9 / 10) an.

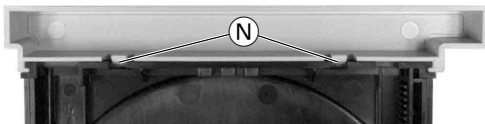
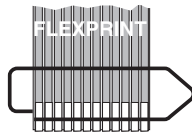

Fig. 5

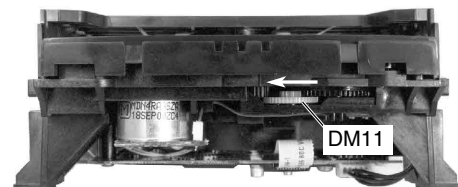

Fig. 6

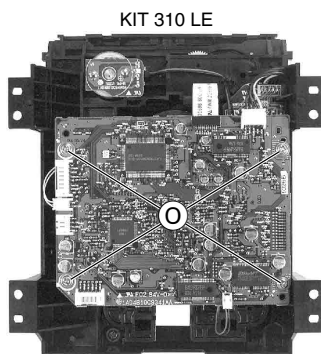

Fig. 7

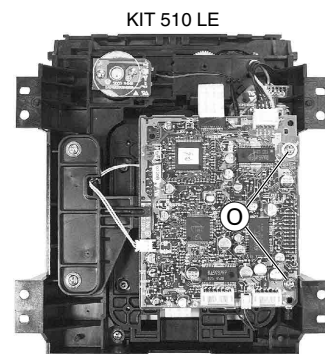

Fig. 8

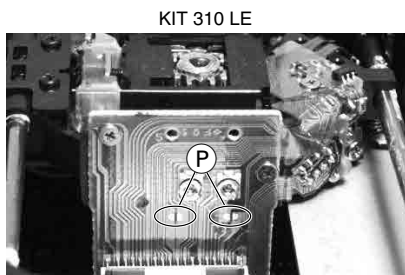

Fig. 9



Fig. 10

8. Drive Mechanism Unit

- Remove the front trim (Point 3).
- Undo the 3 screws **(B)** (Fig. 1) and the screw **(C)**.
- Slide the drive mechanism unit to the left then remove it.
- Unplug the connectors if necessary.

Reassembly hint

- For reassembly, the digital board must be located above the feet of the drive mechanism unit.

9. Disassembling the Drive Mechanism

- Remove the drive mechanism unit (Point 8).

9.1 Removing the Drive Board

- Undo the screws **(O)** (Fig. 7 / 8) then remove the drive board.
- Unplug the connectors if necessary.

Attention: The laser unit is very sensitive to static charges (MOS components)! For this reason, **before disconnecting** the Flexprint lead from the laser unit, short-circuit it by means of a paper clip or apply the protective soldering points **(P)** (Fig. 9 / 10).

9.2 Schublade ausbauen

- Zahnrad DM11 (Fig. 6) in Pfeilrichtung drehen bis sich die Schublade bewegt, dann komplett herausziehen.
- 2 Schrauben ① (Fig. 11) herausdrehen.
- Rastnasen ② (Fig. 11) lösen und Laufwerkoberteil abnehmen.
- Schublade abnehmen.

Montagehinweis:

- Zahnrad DM14 (Fig. 12) so drehen, dass zwischen den Markierungen ③ der Steg ④ des Zahnrades DM16 gegenüber steht.
- Schublade so aufsetzen, dass der mittlere Zahn ⑤ (Fig. 13) der Schublade in die markierte Lücke ⑥ des Zahnrades greift.
- Schublade durch Montage des Laufwerkoberteils fixieren.

9.3 Lademotor ausbauen

- Riemen DM07 (Fig. 12) abnehmen.
- 2 Schrauben ⑦ (Fig. 12) herausdrehen und Lademotor herausnehmen.

9.4 Sledge-Motor ausbauen

- Laufwerk-Platte ausbauen (Punkt 9.1).
- 2 Schrauben ⑧ (Fig. 14) herausdrehen und Sledge-Motor nach unten herausnehmen.

9.5 Laufwerk ausbauen

- Laufwerk-Platte ausbauen (Punkt 9.1).
- Gegebenenfalls Kabel frei legen.
- 4 Schrauben ⑨ (Fig. 14) herausdrehen.
- Rastnasen ⑩ (Fig. 14) lösen und Laufwerk herausnehmen.

Montagehinweis zum Einbau eines neuen Laufwerks:

- Flexprint an der Lasereinheit und an CN100 der Laufwerk-Platte anschließen.
- Werkseitig angebrachte Schutzlötstellen ⑪ der Lasereinheit entfernen (Fig. 9 / 10)

9.2 Removing the Tray

- Turn the toothed wheel DM11 (Fig. 6) in direction of the arrow until the tray moves then pull out the tray.
- Undo the 2 screws ① (Fig. 11).
- Undo the locking lugs ② (Fig. 11) then remove the top part of the drive mechanism.
- Remove the tray.

Reassembly hint:

- Turn the toothed wheel DM14 (Fig. 12) so that it faces on the rib ③ the toothed wheel DM16 between the marks ④.
- Fit the tray so that the centre tooth ⑤ (Fig. 13) of the tray engages into the marked gap ⑥ of the toothed wheel.
- Fix the tray by mounting the upper part of the drive mechanism.

9.3 Removing the Loading Motor

- Remove the belt DM07 (Fig. 12).
- Undo the 2 screws ⑦ (Fig. 12) then remove the loading motor.

9.4 Removing the Sledge Motor

- Remove the drive board (point 9.1).
- Undo the 2 screws ⑧ (Fig. 14) then remove the sledge motor in downward direction.

9.5 Removing the Drive Mechanism

- Remove the drive board (point 9.1).
- Expose the cable if necessary.
- Undo the 4 screws ⑨ (Fig. 14).
- Undo the locking lugs ⑩ (Fig. 14) then remove the drive mechanism.

Instructions for Mounting a new Drive Mechanism

- Connect the Flexprint lead to the laser unit and to CN100 on the drive board.
- Remove the factory-applied protective soldering joints ⑪ from the laser unit (Fig. 9 / 10).

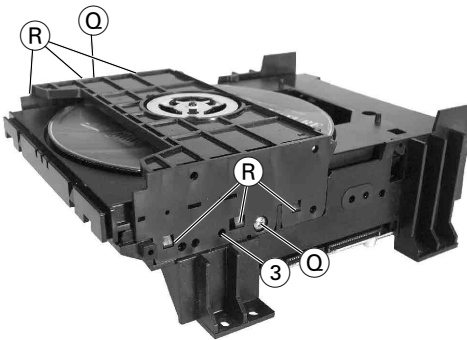

Fig. 11

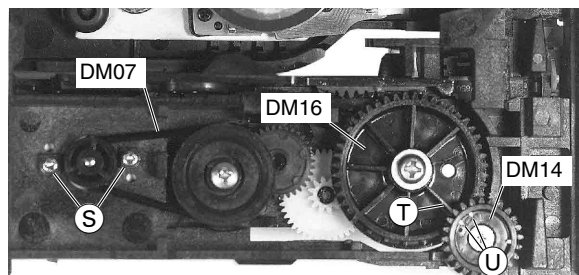

Fig. 12

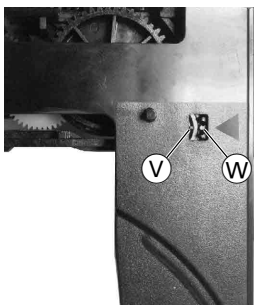

Fig. 13

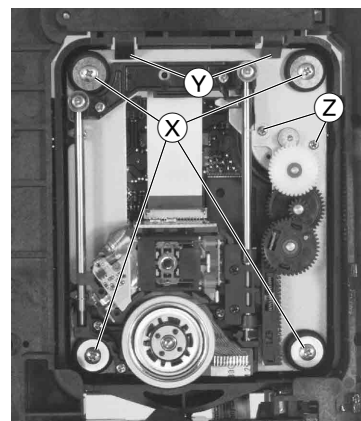
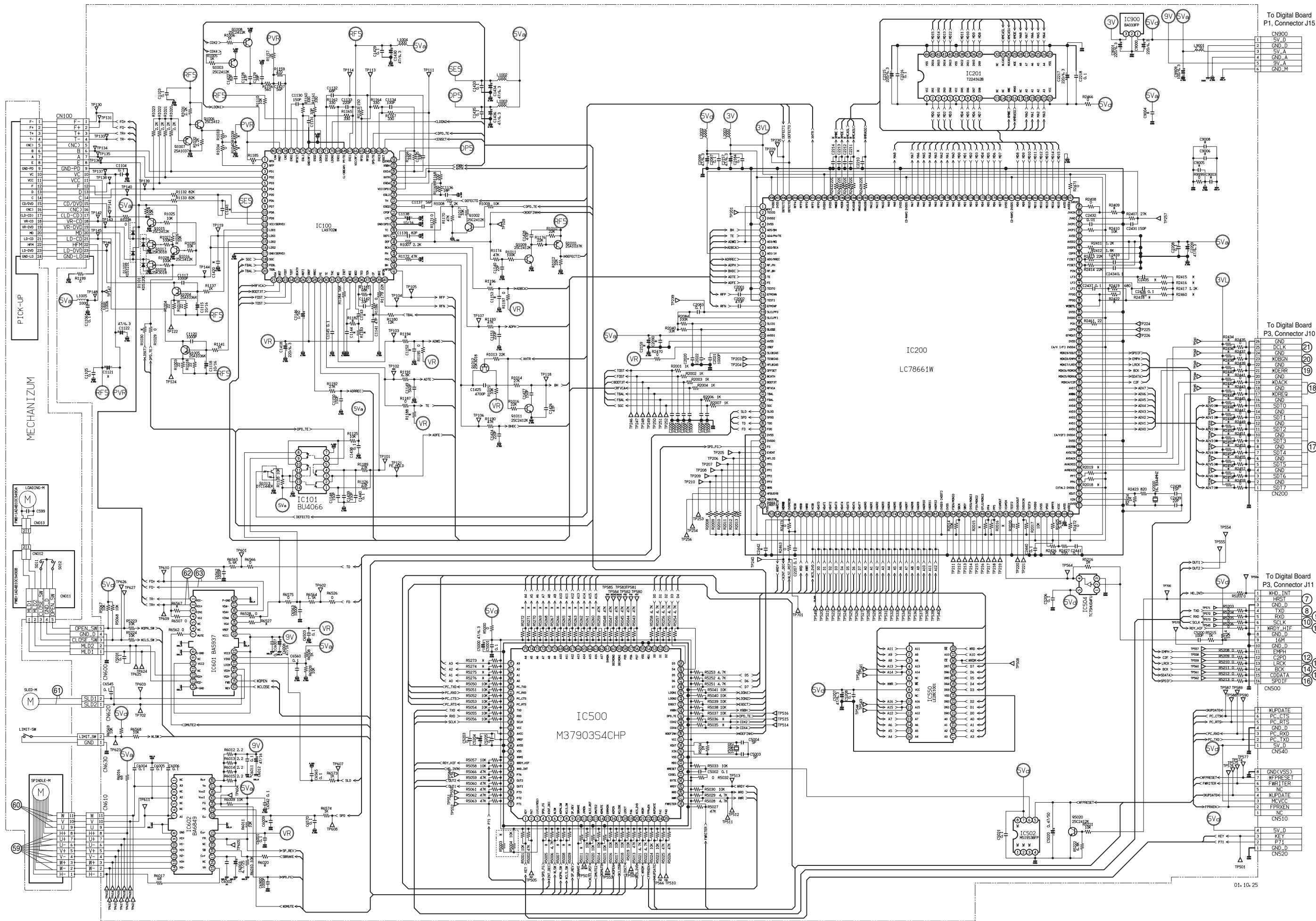
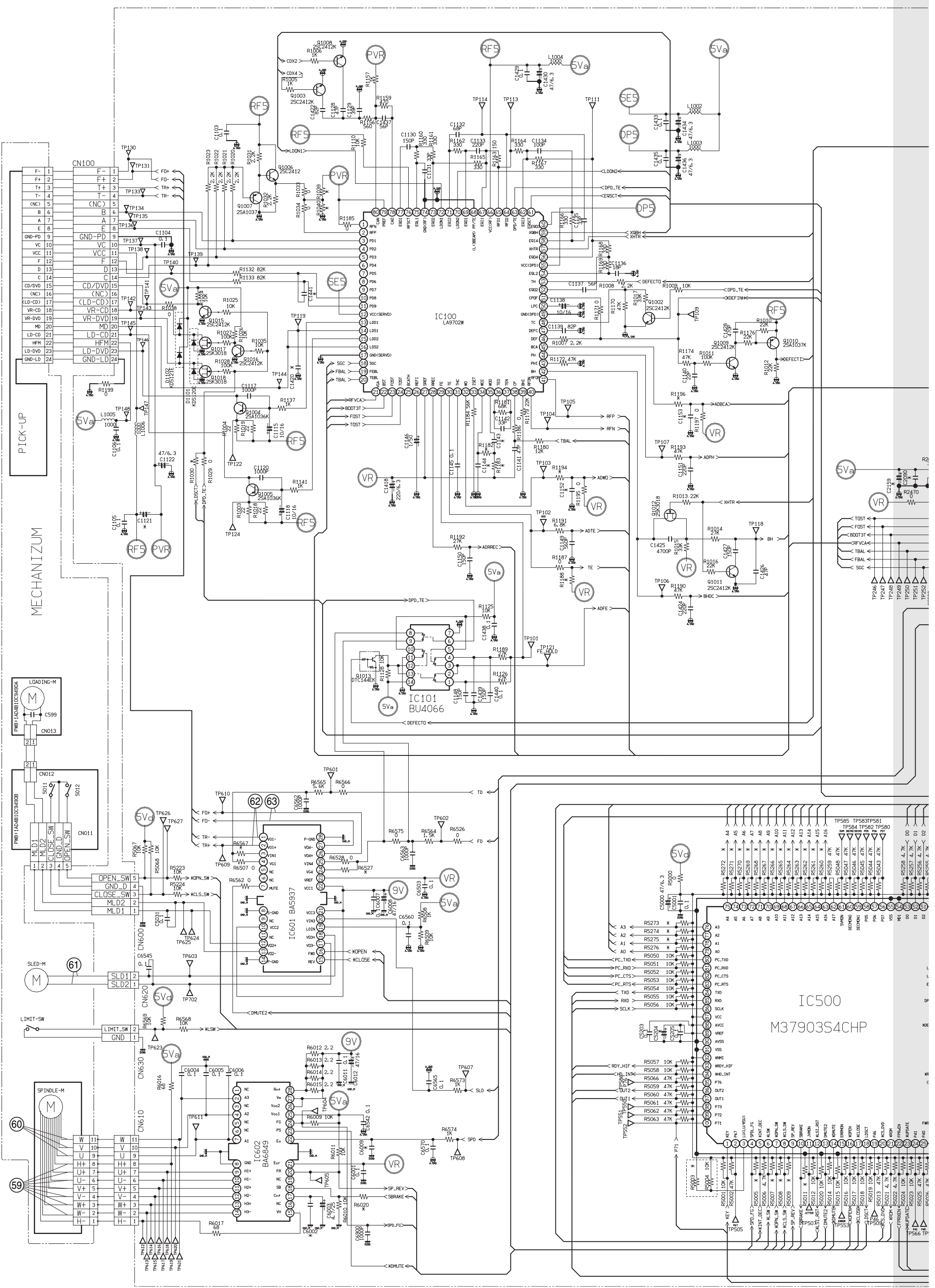

Fig. 14

Laufwerk-Platte / Drive Board "KIT 510 LE"



Laufwerk-Platte / Drive Board "KIT 510 LE" (vergrößert / enlarged)



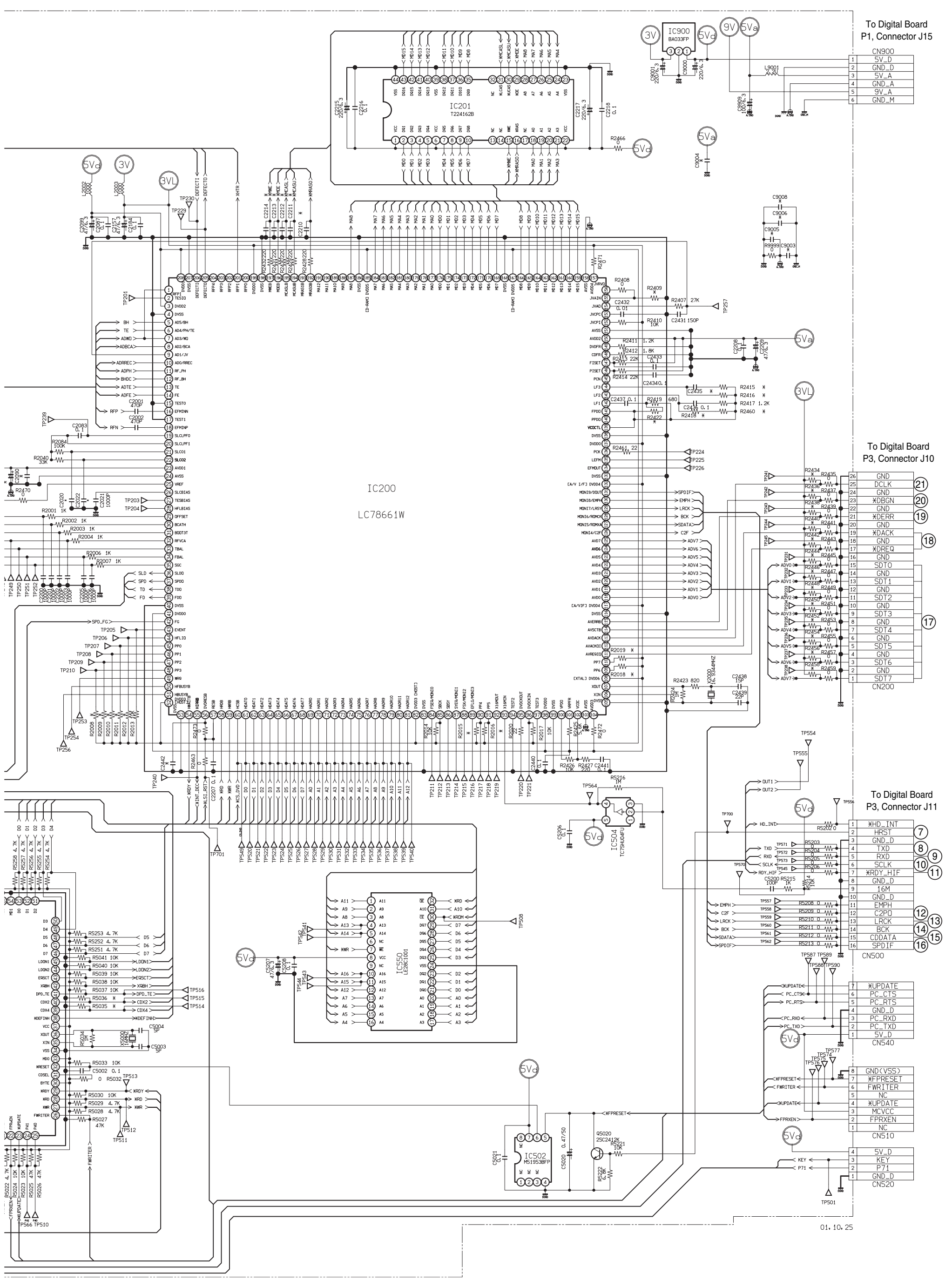

01, 10, 25

Explosionszeichnung und Ersatzteillisten Exploded View and Spare Parts Lists

KIT 510 LE

1

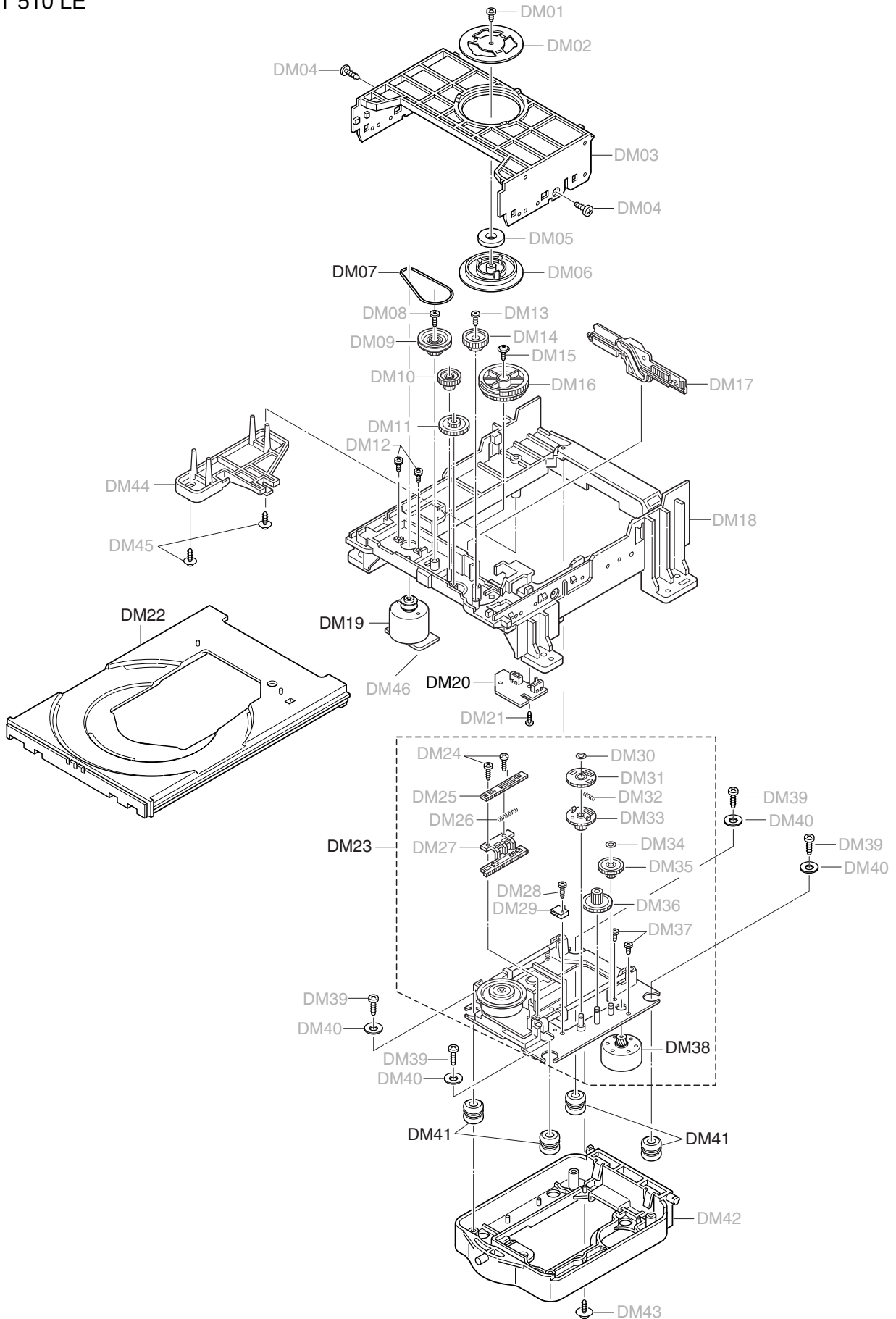

Ersatzteilliste
Spare Parts List

DVD

1 / 2002

ERSETZTE AUSGABE 5/2001
SUBSTITUTE EDITION 5/2001MATERIAL-NR. / PART NO.: 926710150701
BESTELL-NR. / ORDER NO.: GMI8600 SCHWARZ/BLACK

POS. NR. POS. NO.	ABB. FIG.	MATERIAL-NR. PART NUMBER	ANZ. QTY.	BEZEICHNUNG (D)	DESCRIPTION (GB)
		926710150701		XENARO GDP5100 SCHWARZ KEIN E-TEIL	XENARO GDP5100 BLACK NO SPARE PART
0001.000	2	267210030101		ABDECKUNG OBEN	TOP COVER
0004.000	2	267120210101		FRONTBLLENDE SCHWARZ	FRONT PANEL BLACK
0009.000	2	267160020001	4	FUSS GUMMI	RUBBER FEET
0010.000	△ 2	267275000301	X	DVD-LAUFWERK DVD-KIT310LE KEIN E-TEIL	DVD-DRIVE MECHANISM DVD-KIT310LE NO SPARE PART
WW.	△ 2	267275000402	X	DVD-LAUFWERK KITS10LE KEIN E-TEIL	DVD DRIVE SANYO KITS10LE NO SPARE PART
0011.000	2	267290620101	X	DVD-DIGITALPLATTE	DVD-DIGITAL BOARD
0012.000	△ 2	267270150101	X	DVD-NETZTEILPLATTE PSSH370603B	DVD-POWER SUPPLY PSU PSSH370603B
0013.000	2	267290660101	X	DVD-ANALOGPLATTE KEIN E-TEIL	DVD-ANALOG BOARD NO SPARE PART
0014.000	2	267290600501	X	DVD-BEDIENPLATTE KPL KEIN E-TEIL	DVD-CONTROL BOARD ASSY NO SPARE PART
0015.000	2	267170080101		ABDECKUNG SCHUBLADE	DRAWER COVER
0016.000	2	267260310001		FLEXIBLE LEITUNG 16POL	FLEXIBLE CABLE 16POL
0017.000	2	267260320001		FLEXIBLE LEITUNG 26POL	FLEXIBLE CABLE 26POL
0018.000	2	267260330001		FLEXIBLE LEITUNG 6POL	FLEXIBLE CABLE 6POL
0019.000	2	267260340001		FLEXIBLE LEITUNG 18POL	FLEXIBLE CABLE 18POL
0020.000	2	267260360001		FLEXIBLE LEITUNG 20POL	FLEXIBLE CABLE 20POL
0021.000	2	267260350001		FLEXIBLE LEITUNG 16POL	FLEXIBLE CABLE 16POL
0022.000	2	267140100002		TASTENREIHE LINKS	BUTTON SET LEFT
0023.000	2	267140090101		TASTENSATZ RECHTS	BUTTONS RIGHT
0024.000	2	267130130002		FENSTER	WINDOW
0027.000	△	829099122000		NETZKABEL KPL	POWER CABLE CPL
0028.000		267280120101		TP 83 D FERNBEDIENUNG	TP 83 D REMOTE CONTROL
		275990172000		SOFTWARE UPGRADE CD-ROM XENARO 5XX/6XX	SOFTWARE UPGRADE CD-ROM XENARO 5XX/6XX
		267109413901		BEDIENUNGSANLEITUNG D/GB/F/NL/S/E/P	USER MANUAL D/GB/F/NL/S/E/P
		720105408500		SERVICE MANUAL D/GB	SERVICE MANUAL D/GB
		720105408600		SERVICE MANUAL D/GB 1.ERGAENZUNG	SERVICE MANUAL D/GB 1ST SUPPLEMENT
		720105408700		SERVICE MANUAL D/GB 2.ERGAENZUNG	SERVICE MANUAL D/GB 2ND SUPPLEMENT
				X = SIEHE GESONDERTE E-LISTE	X = SEE SEPARATE PARTS LIST

Es gelten die Vorschriften und Sicherheitshinweise gemäß dem Service Manual "Sicherheit", Mat.-Nummer 720108000000, sowie zusätzlich die eventuell abweichenden, landesspezifischen Vorschriften!



The regulations and safety instructions shall be valid as provided by the "Safety" Service Manual, part number 720108000000, as well as the respective national deviations.

ÄNDERUNGEN VORBEHALTEN / SUBJECT TO ALTERATION

Ersatzteilliste
Spare Parts List

DVD

1 / 2002

ERSETZTE AUSGABE 5/2001
SUBSTITUTE EDITION 5/2001MATERIAL-NR. / PART NO.: 926710150101 BESTELL-NR. / ORDER NO.: GMI6100
MATERIAL-NR. / PART NO.: 926710150601 BESTELL-NR. / ORDER NO.: GMI8700

POS. NR. POS. NO.	ABB. FIG.	MATERIAL-NR. PART NUMBER	ANZ. QTY.	BEZEICHNUNG (D)	DESCRIPTION (GB)
		926710150101		XENARO GDP5100/1 SILBER KEIN E-TEIL	XENARO GDP5100/1 SILVER NO SPARE PART
		926710150601		XENARO GDP5100/2 SILBER KEIN E-TEIL	XENARO GDP5100/2 SILVER NO SPARE PART
0001.000	2	267210030001		GEH-OBERTEIL	TOP COVER
0004.000	2	267120210002		FRONTBLLENDE SILBER KPL	FRONT PANEL SILVER CPL
0009.000	2	267160020001	4	FUSS GUMMI	RUBBER FEET
0010.000	△ 2	267275000301	X	DVD-LAUFWERK DVD-KIT310LE KEIN E-TEIL	DVD-DRIVE DVD-KIT310LE NO SPARE PART
WW.	△ 2	267275000402	X	DVD-LAUFWERK KITS10LE KEIN E-TEIL	DVD DRIVE SANYO KITS10LE NO SPARE PART
0011.000	2	267290620101	X	DVD-DIGITALPLATTE KPL.	DVD-DIGITAL BOARD CPL
0012.000	△ 2	267270150101	X	DVD-NETZTEILPLATTE PSSH370603B	DVD-POWER SUPPLY PSSH370603B
0013.000	2	267290660101	X	DVD-ANALOGPLATTE KPL. KEIN E-TEIL	DVD-ANALOG BOARD ASSY NO SPARE PART
0014.000	2	267290600501	X	DVD-BEDIENPLATTE KPL. KEIN E-TEIL	DVD-CONTROL BOARD ASSY NO SPARE PART
0015.000	2	267170080002		ABDECKUNG SCHUBLADE	DRAWER COVER
0016.000	2	267260310001		FLEXIBLELEITUNG 16POL	FLEXIBLE CABLE 16POL
0017.000	2	267260320001		FLEXIBLELEITUNG 26POL	FLEXIBLE CABLE 26POL
0018.000	2	267260330001		FLEXIBLELEITUNG 6POL	FLEXIBLE CABLE 6POL
0019.000	2	267260340001		FLEXIBLELEITUNG 18POL	FLEXIBLE CABLE 18POL
0020.000	2	267260360001		FLEXIBLELEITUNG 20POL	FLEXIBLE CABLE 20POL
0021.000	2	267260350001		FLEXIBLELEITUNG 16POL	FLEXIBLE CABLE 16POL
0022.000	2	267140070002		TASTENLEISTE LINKS	BUTTON SET LEFT
0023.000	2	267140090002		TASTENLEISTE RECHTS	BUTTON SET RIGHT
0024.000	2	267130130002		FENSTER	WINDOW
0027.000	△	829099122000		NETZKABEL KPL	POWER CABLE CPL
0028.000		267280120101		TP 83 D FERNBEDIENUNG	TP 83 D REMOTE CONTROL
		275990172000		SOFTWARE UPGRADE CD-ROM XENARO 5XX/6XX	SOFTWARE UPGRADE CD-ROM XENARO 5XX/6XX
		267109413301		BEDIENUNGSANLEITUNG D/GB/F/I/NL	INSTRUCTION MANUAL D/GB/F/I/NL
		267109413401		BEDIENUNGSANLEITUNG D/GB/DK/N/S/FIN/E/P	INSTRUCTION MANUAL D/GB/DK/N/S/FIN/E/P
		720105408500		SERVICE MANUAL D/GB	SERVICE MANUAL D/GB
		720105408600		SERVICE MANUAL D/GB 1.ERGAENZUNG	SERVICE MANUAL D/GB 1ST SUPPLEMENT
		720105408700		SERVICE MANUAL D/GB 2.ERGAENZUNG	SERVICE MANUAL D/GB 2ND SUPPLEMENT
				X = SIEHE GESONDERTE E-LISTE	X = SEE SEPARATE PARTS LIST

Es gelten die Vorschriften und Sicherheitshinweise gemäß dem Service Manual "Sicherheit", Mat.-Nummer 720108000000, sowie zusätzlich die eventuell abweichenden, landesspezifischen Vorschriften!



The regulations and safety instructions shall be valid as provided by the "Safety" Service Manual, part number 720108000000, as well as the respective national deviations.

ÄNDERUNGEN VORBEHALTEN / SUBJECT TO ALTERATION

Ersatzteilliste
Spare Parts List**1 / 2002**ERSETZTE AUSGABE 5/2001
SUBSTITUTE EDITION 5/2001

POS. NR. POS. NO.	ABB. FIG.	MATERIAL-NR. PART NUMBER	ANZ. QTY.	BEZEICHNUNG (D)	DESCRIPTION (GB)
		926710150401		XENARO GDP 5102 SILBER KEIN E-TEIL	XENARO GDP 5102 SILVER NO SPARE PART
0001.000	2	267210030001		GEH-OBERTEIL	TOP COVER
0004.000	2	267120210002		FRONTBLENDE SILBER KPL.	FRONT PANEL SILVER
0009.000	2	267160020001	4	FUSS GUMMI	RUBBER FEET
0010.000	△ 2	267275000301	X	DVD-LAUFWERK DVD-KIT310LE KEIN E-TEIL	DVD-DRIVE DVD-KIT310LE NO SPARE PART
WW.	△ 2	267275000402	X	DVD-LAUFWERK KIT510LE KEIN E-TEIL	DVD DRIVE SANYO KITS10LE NO SPARE PART
0011.000	2	267290620101	X	DVD-DIGITALPLATTE	DVD-DIGITAL BOARD
0012.000	△ 2	267270150101	X	DVD-NETZTEILPLATTE PSSH370603B	DVD-POWER SUPPLY PSSH370603B
0013.000	2	267290660101	X	DVD-ANALOGPLATTE KPL. KEIN E-TEIL	DVD-ANALOG BOARD ASSY NO SPARE PART
0014.000	2	267290600501	X	DVD-BEDIENPLATTE KPL. KEIN E-TEIL	DVD-CONTROL BOARD ASSY NO SPARE PART
0015.000	2	267170080002		ABDECKUNG SCHUBLADE	DRAWER COVER
0016.000	2	267260310001		FLEXIBLE LEITUNG 16POL	FLEXIBLE CABLE 16POL
0017.000	2	267260320001		FLEXIBLE LEITUNG 26POL	FLEXIBLE CABLE 26POL
0018.000	2	267260330001		FLEXIBLE LEITUNG 6POL	FLEXIBLE CABLE 6POL
0019.000	2	267260340001		FLEXIBLE LEITUNG 18POL	FLEXIBLE CABLE 18POL
0020.000	2	267260360001		FLEXIBLE LEITUNG 20POL	FLEXIBLE CABLE 20POL
0021.000	2	267260350001		FLEXIBLE LEITUNG 16POL	FLEXIBLE CABLE 16POL
0022.000	2	267140070002		TASTENLEISTE LINKS	BUTTON SET LEFT
0023.000	2	267140090002		TASTENLEISTE RECHTS	BUTTON SET RIGHT
0024.000	2	267130130002		FENSTER	WINDOW
0027.000	△	829099122000		NETZKABEL KPL	POWER CABLE CPL
0028.000		267280120101		TP 83 D FERNBEDIENUNG	TP 83 D REMOTE CONTROL
		275990172000		SOFTWARE UPGRADE CD-ROM XENARO 5XX/6XX	SOFTWARE UPGRADE CD-ROM XENARO 5XX/6XX
		267109413601		BEDIENUNGSANLEITUNG GB	OPERATING INSTRUCTION GB
		720105408500		SERVICE MANUAL D/GB	SERVICE MANUAL D/GB
		720105408600		SERVICE MANUAL D/GB 1.ERGAENZUNG	SERVICE MANUAL D/GB 1ST SUPPLEMENT
		720105408700		SERVICE MANUAL D/GB 2.ERGAENZUNG	SERVICE MANUAL D/GB 2ND SUPPLEMENT
				X = SIEHE GESONDERTE E-LISTE	X = SEE SEPARATE PARTS LIST

Es gelten die Vorschriften und Sicherheitshinweise gemäß dem Service Manual "Sicherheit", Mat.-Nummer 720108000000, sowie zusätzlich die eventuell abweichenden, landesspezifischen Vorschriften!



The regulations and safety instructions shall be valid as provided by the "Safety" Service Manual, part number 720108000000, as well as the respective national deviations.

ÄNDERUNGEN VORBEHALTEN / SUBJECT TO ALTERATION

GRUNDIG**DVD****XENARO GDP 5102**MATERIAL-NR. / PART NO.: 926710150401
BESTELL-NR. / ORDER NO.: GMI8900 SILBER/SILVER**GRUNDIG****DVD****XENARO GDP 5105**MATERIAL-NR. / PART NO.: 926710151101
BESTELL-NR. / ORDER NO.: GMI9700Ersatzteilliste
Spare Parts List**12 / 2001**

POS. NR. POS. NO.	ABB. FIG.	MATERIAL-NR. PART NUMBER	ANZ. QTY.	BEZEICHNUNG (D)	DESCRIPTION (GB)
		926710151101		XENARO GDP 5105 SILBER KEIN E-TEIL	XENARO GDP 5105 SILVER NO SPARE PART
0001.000	2	267210030001		GEH-OBERTEIL	TOP COVER
0004.000	2	267120210002		FRONTBLENDE SILBER KPL.	FRONT PANEL SILVER CPL
0009.000	2	267160020001	4	FUSS GUMMI	RUBBER FEET
0010.000	△ 2	267275000402	X	DVD-LAUFWERK DVD-KIT510LE KEIN E-TEIL	DVD-DRIVE DVD-KIT510LE NO SPARE PART
0011.000	2	267290870101	X	DVD-DIGITALPLATTE KPL.	DVD-DIGITAL BOARD CPL
0012.000	△ 2	267270150101	X	DVD-NETZTEILPLATTE PSSH370603B	DVD-POWER SUPPLY PSSH370603B
0013.000	2	267290660101	X	DVD-ANALOGPLATTE KPL. KEIN E-TEIL	DVD-ANALOG BOARD ASSY NO SPARE PART
0014.000	2	267290600501	X	DVD-BEDIENPLATTE KPL. KEIN E-TEIL	DVD-CONTROL BOARD ASSY NO SPARE PART
0015.000	2	267170080002		ABDECKUNG SCHUBLADE	DRAWER COVER
0016.000	2	267260310001		FLEXIBLE LEITUNG 16POL	FLEXIBLE CABLE 16POL
0017.000	2	267260320001		FLEXIBLE LEITUNG 26POL	FLEXIBLE CABLE 26POL
0018.000	2	267260330001		FLEXIBLE LEITUNG 6POL	FLEXIBLE CABLE 6POL
0019.000	2	267260340001		FLEXIBLE LEITUNG 18 POL	FLEXIBLE CABLE 18POL
0020.000	2	267260360001		FLEXIBLE LEITUNG 20POL	FLEXIBLE CABLE 20POL
0021.000	2	267260350001		FLEXIBLE LEITUNG 16POL	FLEXIBLE CABLE 16POL
0022.000	2	267140070002		TASTENLEISTE LINKS	BUTTON SET LEFT
0023.000	2	267140090002		TASTENLEISTE RECHTS	BUTTON SET RIGHT
0024.000	2	267130130002		FENSTER	WINDOW
0027.000	△	829099122000		NETZKABEL KPL	POWER CABLE CPL
0028.000		267280120001		TP 81 D FERNBEDIENUNG	TP 81 D REMOTE CONTROL
		275990172900		SOFTWARE UPGRADE CD-ROM	SOFTWARE UPGRADE CD-ROM
		267109415301		BEDIENUNGSANLEITUNG GB/CS/PL/HU	INSTRUCTION MANUAL GB/CS/PL/HU
		720105408500		SERVICE MANUAL D/GB	SERVICE MANUAL D/GB
		720105408600		SERVICE MANUAL D/GB 1.ERGAENZUNG	SERVICE MANUAL D/GB 1ST SUPPLEMENT
		720105408700		SERVICE MANUAL D/GB 2.ERGAENZUNG	SERVICE MANUAL D/GB 2ND SUPPLEMENT
				X = SIEHE GESONDERTE E-LISTE	X = SEE SEPARATE PARTS LIST

Es gelten die Vorschriften und Sicherheitshinweise gemäß dem Service Manual "Sicherheit", Mat.-Nummer 720108000000, sowie zusätzlich die eventuell abweichenden, landesspezifischen Vorschriften!



The regulations and safety instructions shall be valid as provided by the "Safety" Service Manual, part number 720108000000, as well as the respective national deviations.

ÄNDERUNGEN VORBEHALTEN / SUBJECT TO ALTERATION

Ersatzteilliste
Spare Parts List

DVD

1 / 2002

XENARO GDP 5120

ERSETZTE AUSGABE 7/2001
SUBSTITUTE EDITION 7/2001MATERIAL-NR. / PART NO.: 926710150301
BESTELL-NR. / ORDER NO.: GMI9200 SILBER/SILVER

POS. NR. POS. NO.	ABB. FIG.	MATERIAL-NR. PART NUMBER	ANZ. QTY.	BEZEICHNUNG D	DESCRIPTION GB
		926710150301		XENARO GDP 5120 SILBER KEIN E-TEIL	XENARO GDP 5120 SILVER NO SPARE PART
0001.000	4	267210030001		GEH-OBERTEIL	TOP COVER
0004.000	4	267120210003		FRONTBLLENDE SILBER KPL.	FRONT PANEL SILVER CPL
0009.000	4	267160020001	4	FUSS GUMMI	RUBBER FEET
0010.000	△ 4	267275000301	X	DVD-LAUFWERK DVD-KIT310LE KEIN E-TEIL	DVD-DRIVE DVD-KIT310LE NO SPARE PART
WW.	△ 4	267275000402	X	DVD-LAUFWERK KITS10LE KEIN E-TEIL	DVD DRIVE SANYO KITS10LE NO SPARE PART
0011.000	4	267290730101	X	DVD-DIGITALPLATTE	DVD DIGITAL BOARD
0012.000	△ 4	267270150001	X	DVD-NETZTEILPLATTE PSSH370603A	DVD POWER SUPPLY PSSH370603A
0013.000	4	267290740101	X	DVD-ANALOGPLATTE KPL. KEIN E-TEIL	DVD ANALOG BOARD ASSY NO SPARE PART
0014.000	4	267290600201	X	DVD-BEDIENPLATTE KPL. KEIN E-TEIL	DVD CONTROL BOARD ASSY NO SPARE PART
0015.000	4	267170080003		ABDECKUNG SCHUBLADE	DRAWER COVER
0016.000	4	267260310001		FLEXIBLE LEITUNG 16-POL	FLEXIBLE CABLE 16P
0017.000	4	267260320001		FLEXIBLE LEITUNG 26-POL	FLEXIBLE CABLE 26P
0018.000	4	267260330001		FLEXIBLE LEITUNG 6-POL	FLEXIBLE CABLE 6P
0019.000	4	267260340001		FLEXIBLE LEITUNG 18-POL	FLEXIBLE CABLE 18P
0020.000	4	267260360001		FLEXIBLE LEITUNG 20-POL	FLEXIBLE CABLE 20P
0021.000	4	267260350001		FLEXIBLE LEITUNG 16-POL	FLEXIBLE CABLE 16P
0022.000	4	267140070002		TASTENLEISTE LINKS	BUTTON SET LEFT
0023.000	4	267140090002		TASTENLEISTE RECHTS	BUTTON SET RIGHT
0024.000	△ 4	267130120001		FENSTER	WINDOW
0027.000	△	829099122000		NETZKABEL KPL	POWER CABLE CPL
0028.000		267280120101		TP 83 D FERNBEDIENUNG	TP 83 D REMOTE CONTROL
		267109414001		BEDIENUNGSANLEITUNG D/GB/F//NL	INSTRUCTION MANUAL D/GB/F//NL
		720105408500		SERVICE MANUAL D/GB	SERVICE MANUAL D/GB
		720105408600		SERVICE MANUAL D/GB 1.ERGAENZUNG	SERVICE MANUAL D/GB 1ST SUPPLEMENT
		720105408700		SERVICE MANUAL D/GB 2.ERGAENZUNG	SERVICE MANUAL D/GB 2ND SUPPLEMENT

X = SIEHE GESONDERTE E-LISTE

X = SEE SEPARATE PARTS LIST

Es gelten die Vorschriften und Sicherheitshinweise gemäß dem Service Manual "Sicherheit", Mat.-Nummer 720108000000, sowie zusätzlich die eventuell abweichenden, landesspezifischen Vorschriften!



The regulations and safety instructions shall be valid as provided by the "Safety" Service Manual, part number 720108000000, as well as the respective national deviations.

ÄNDERUNGEN VORBEHALTEN / SUBJECT TO ALTERATION

Ersatzteilliste
Spare Parts List

DVD

1 / 2002

XENARO GDP 6150/1
XENARO GDP 6150/2 *ERSETZTE AUSGABE 5/2001
SUBSTITUTE EDITION 5/2001MATERIAL-NR. / PART NO.: 926710150001 BESTELL-NR. / ORDER NO.: GMI6000
MATERIAL-NR. / PART NO.: 926710150501 BESTELL-NR. / ORDER NO.: GMI9300 *

POS. NR. POS. NO.	ABB. FIG.	MATERIAL-NR. PART NUMBER	ANZ. QTY.	BEZEICHNUNG D	DESCRIPTION GB
		926710150001		XENARO GDP6150/1 KEIN E-TEIL	XENARO GDP6150/1 NO SPARE PART
		926710150501		XENARO GDP6150/2 * KEIN E-TEIL	XENARO GDP6150/2 * NO SPARE PART
0001.000	3	267210030001		GEH-OBERTEIL	TOP COVER
0004.000	3	267120200002		FRONTBLLENDE SILBER	FRONT PANEL SILVER
0009.000	3	267160020001	4	FUSS GUMMI	RUBBER FEET
0010.000	△ 2	267275000301	X	DVD-LAUFWERK DVD-KIT310LE KEIN E-TEIL	DVD-DRIVE MECHANISM DVD-KIT310LE NO SPARE PART
WW.	△ 2	267275000402	X	DVD-LAUFWERK KITS10LE KEIN E-TEIL	DVD DRIVE SANYO KITS10LE NO SPARE PART
0011.000	3	267290510101	X	DVD-DIGITALPLATTE	DVD-DIGITAL BOARD
0012.000	△ 3	267270150001	X	DVD-NETZTEIL KPL	DVD-POWER SUPPLY PSSH370603A
0013.000	3	267290520101	X	DVD-ANALOGPLATTE KPL. KEIN E-TEIL	DVD-ANALOG BOARD ASSY NO SPARE PART
0014.000	3	267290530501	X	DVD-BEDIENPLATTE KPL. KEIN E-TEIL	DVD-CONTROL BOARD ASSY NO SPARE PART
0015.000	3	267170080001		ABDECKUNG SCHUBLADE	DRAWER COVER
0016.000	3	267260310001		FLEXIBLE LEITUNG 16POL	FLEXIBLE CABLE 16POL
0017.000	3	267260320001		FLEXIBLE LEITUNG 26POL	FLEXIBLE CABLE 26POL
0018.000	3	267260330001		FLEXIBLE LEITUNG 6POL	FLEXIBLE CABLE 6POL
0019.000	3	267260340001		FLEXIBLE LEITUNG 18POL	FLEXIBLE CABLE 18POL
0020.000	3	267260360001	2	FLEXIBLE LEITUNG 20POL	FLEXIBLE CABLE 20POL
0021.000	3	267260350001		FLEXIBLE LEITUNG 16POL	FLEXIBLE CABLE 16POL
0022.000	3	267170060001		DREHSCHALTERGEHAEUSE	ROTARY SWITCH
0023.000	3	267170070001		HUELSE DREHSCHALTER	ROTARY SWITCH SLEEVE
0024.000	3	267130120001		FENSTER	WINDOW
0025.000	3	267140070001		TASTENLEISTE LINKS	BUTTON SET LEFT
0026.000	3	267140080001		TASTENSET RECHTS	BUTTON SET RIGHT
0027.000	△	829099122000		NETZKABEL KPL	POWER CABLE CPL
0028.000		267280120101		TP 83 D FERNBEDIENUNG	TP 83 D REMOTE CONTROL
		275990172000		SOFTWARE UPGRADE CD-ROM XENARO 5XX/6XX	SOFTWARE UPGRADE CD-ROM XENARO 5XX/6XX
		267109413001		BEDIENUNGSANLEITUNG D/GB/F//NL	OPERATING INSTRUCTION D/GB/F//NL
		267109413201		BEDIENUNGSANLEITUNG GDP6150/2 * D/GB/DK/N/S/FIN/E/P	OPERATING INSTRUCTION GDP6150/2 * D/GB/DK/N/S/FIN/E/P
		720105408500		SERVICE MANUAL D/GB	SERVICE MANUAL D/GB
		720105408600		SERVICE MANUAL D/GB 1.ERGAENZUNG	SERVICE MANUAL D/GB 1ST SUPPLEMENT
		720105408700		SERVICE MANUAL D/GB 2.ERGAENZUNG	SERVICE MANUAL D/GB 2ND SUPPLEMENT

X = SIEHE GESONDERTE E-LISTE

X = SEE SEPARATE PARTS LIST

Es gelten die Vorschriften und Sicherheitshinweise gemäß dem Service Manual "Sicherheit", Mat.-Nummer 720108000000, sowie zusätzlich die eventuell abweichenden, landesspezifischen Vorschriften!



The regulations and safety instructions shall be valid as provided by the "Safety" Service Manual, part number 720108000000, as well as the respective national deviations.

ÄNDERUNGEN VORBEHALTEN / SUBJECT TO ALTERATION

Ersatzteilliste
Spare Parts List

12 / 2001

GRUNDIG

DVD

XENARO GDP 6155

MATERIAL-NR. / PART NO.: 926710151301
BESTELL-NR. / ORDER NO.: GM19600

POS. NR. POS. NO.	ABB. FIG.	MATERIAL-NR. PART NUMBER	ANZ. QTY.	BEZEICHNUNG (D)	DESCRIPTION (GB)
		926710151301		XENARO GDP6155 KEIN E-TEIL	XENARO GDP6155 NO SPARE PART
0001.000	3	267210030001		GEH-OBERTEIL	TOP COVER
0004.000	3	267120200002		FRONTBLENDE SILBER	FRONT PANEL SILVER
0009.000	3	267160020001	4	FUSS GUMMI	RUBBER FEET
0010.000	△	267275000402	X	DVD-LAUFWERK DVD-KIT510LE KPL. KEIN E-TEIL	DVD-DRIVE SANYO DVD-KIT510 ASSY NO SPARE PART
0011.000	3	267290890101	X	DVD-DIGITALPLATTE	DVD-DIGITAL BOARD
0012.000	△	267270150001	X	DVD-NETZTEIL KPL	DVD-POWER SUPPLY PSSH370603A
0013.000	3	267290520101	X	DVD-ANALOGPLATTE KPL. KEIN E-TEIL	DVD-ANALOG BOARD ASSY NO SPARE PART
0014.000	3	267290530501	X	DVD-BEDIENPLATTE KPL. KEIN E-TEIL	DVD-CONTROL BOARD ASSY NO SPARE PART
0015.000	3	267170080001		ABDECKUNG SCHUBLADE	DRAWER COVER
0016.000	3	267260310001		FLEXIBLE LEITUNG 16POL	FLEXIBLE CABLE 16POL
0017.000	3	267260320001		FLEXIBLE LEITUNG 26POL	FLEXIBLE CABLE 26POL
0018.000	3	267260330001		FLEXIBLE LEITUNG 6POL	FLEXIBLE CABLE 6POL
0019.000	3	267260340001		FLEXIBLE LEITUNG 18POL	FLEXIBLE CABLE 18POL
0020.000	3	267260360001	2	FLEXIBLE LEITUNG 20POL	FLEXIBLE CABLE 20POL
0021.000	3	267260350001		FLEXIBLE LEITUNG 16POL	FLEXIBLE CABLE 16POL
0022.000	3	267170060001		DREHSCHALTERGEHAEUSE	ROTARY SWITCH
0023.000	3	267170070001		HUELSE DREHSCHALTER	ROTARY SWITCH SLEEVE
0024.000	3	267130120001		FENSTER	WINDOW
0025.000	3	267140070001		TASTENLEISTE LINKS	BUTTON SET LEFT
0026.000	3	267140080001		TASTENSET RECHTS	BUTTON SET RIGHT
0027.000	△	829099122000		NETZKABEL KPL	POWER CABLE CPL
0028.000		267280120101		TP 83 D FERNBEDIENUNG	TP 83 D REMOTE CONTROL
		275990172900		SOFTWARE UPGRADE CD-ROM	SOFTWARE UPGRADE CD-ROM
		267109415501		BEDIENUNGSANLEITUNG GB/CS/PL/HU	OPERATING INSTRUCTION GB/CS/PL/HU
		720105408500		SERVICE MANUAL D/GB	SERVICE MANUAL D/GB
		720105408600		SERVICE MANUAL D/GB 1.ERGAENZUNG	SERVICE MANUAL D/GB 1ST SUPPLEMENT
		720105408700		SERVICE MANUAL D/GB 2.ERGAENZUNG	SERVICE MANUAL D/GB 2ND SUPPLEMENT
				X = SIEHE GESONDERTE E-LISTE	X = SEE SEPARATE PARTS LIST

Es gelten die Vorschriften und Sicherheitshinweise gemäß dem Service Manual "Sicherheit", Mat.-Nummer 720108000000, sowie zusätzlich die eventuell abweichenden, landesspezifischen Vorschriften!



The regulations and safety instructions shall be valid as provided by the "Safety" Service Manual, part number 720108000000, as well as the respective national deviations.

ÄNDERUNGEN VORBEHALTEN / SUBJECT TO ALTERATION

GRUNDIG

DVD

MALAGA SE 1230

MATERIAL-NR. / PART NO.: 926710150201
BESTELL-NR. / ORDER NO.: GM16200Ersatzteilliste
Spare Parts List

2 / 2002

ERSETZTE AUSGABE 5/2001
SUBSTITUTE EDITION 5/2001

POS. NR. POS. NO.	ABB. FIG.	MATERIAL-NR. PART NUMBER	ANZ. QTY.	BEZEICHNUNG (D)	DESCRIPTION (GB)
		926710150201		MALAGA SE1230 KEIN E-TEIL	MALAGA SE1230 NO SPARE PART
0001.000	2	267210030101		GEH-OBERTEIL	TOP COVER
0004.000	2	267120220002		FRONTPLATTE SCHWARZ	FRONT PANEL BLACK
0009.000	2	267160020001	4	FUSS GUMMI	RUBBER FEET
0010.000	△	267275000301	X	DVD-LAUFWERK DVD-KIT310LE KEIN E-TEIL	DVD-DRIVE DVD-KIT310LE NO SPARE PART
WW.	△	267275000402	X	DVD-LAUFWERK KITS10LE KEIN E-TEIL	DVD DRIVE SANYO KITS10LE NO SPARE PART
0011.000	2	267290700101	X	DVD-DIGITALPLATTE	DVD-DIGITAL BOARD
0012.000	△	267270150101	X	DVD-NETZTEILPLATTE PSSH370603B	DVD-POWER SUPPLY PSSH370603B
0013.000	2	267290660101	X	DVD-ANALOGPLATTE KPL. KEIN E-TEIL	DVD-ANALOG BOARD ASSY NO SPARE PART
0014.000	2	267290650501	X	DVD-BEDIENPLATTE KPL. KEIN E-TEIL	DVD-CONTROL BOARD ASSY NO SPARE PART
0015.000	2	267170080101		ABDECKUNG SCHUBLADE	DRAWER COVER
0016.000	2	267260310001		FLEXIBLE LEITUNG 16POL	FLEXIBLE CABLE 16POL
0017.000	2	267260320001		FLEXIBLE LEITUNG 26POL	FLEXIBLE CABLE 26POL
0018.000	2	267260330001		FLEXIBLE LEITUNG 6POL	FLEXIBLE CABLE 6POL
0019.000	2	267260340001		FLEXIBLE LEITUNG 18POL	FLEXIBLE CABLE 18POL
0020.000	2	267260360001		FLEXIBLE LEITUNG 20POL	FLEXIBLE CABLE 20POL
0021.000	2	267260350001		FLEXIBLE LEITUNG 16POL	FLEXIBLE CABLE 16POL
0022.000	2	267140100002		TASTENLEISTE LINKS	BUTTON SET LEFT
0023.000	2	267140110002		TASTENLEISTE RECHTS	BUTTON SET RIGHT
0024.000	2	267140120001		KNOPF OK	BUTTON OK
0025.000	2	267130130002		FENSTER	WINDOW
0027.000	△	829099122000		NETZKABEL KPL	POWER CABLE CPL
0028.000		267280120101		TP 83 D FERNBEDIENUNG	TP 83 D REMOTE CONTROL
		275990172000		SOFTWARE UPGRADE CD-ROM XENARO 5XX/6XX	SOFTWARE UPGRADE CD-ROM XENARO 5XX/6XX
		267109413501		BEDIENUNGSANLEITUNG D/GB/F/I/DK/E/P	OPERATING INSTRUCT. D/GB/F/I/DK/N/E/PD
		267109414201		BEDIENUNGSANLEITUNG S/FIN/E/P	OPERATING INSTRUCTION S/FIN/E/P
		720105408500		SERVICE MANUAL D/GB	SERVICE MANUAL D/GB
		720105408600		SERVICE MANUAL D/GB 1.ERGAENZUNG	SERVICE MANUAL D/GB 1ST SUPPLEMENT
		720105408700		SERVICE MANUAL D/GB 2.ERGAENZUNG	SERVICE MANUAL D/GB 2ND SUPPLEMENT
				X = SIEHE GESONDERTE E-LISTE	X = SEE SEPARATE PARTS LIST

Es gelten die Vorschriften und Sicherheitshinweise gemäß dem Service Manual "Sicherheit", Mat.-Nummer 720108000000, sowie zusätzlich die eventuell abweichenden, landesspezifischen Vorschriften!



The regulations and safety instructions shall be valid as provided by the "Safety" Service Manual, part number 720108000000, as well as the respective national deviations.

ÄNDERUNGEN VORBEHALTEN / SUBJECT TO ALTERATION

Ersatzteilliste
Spare Parts List

DVD

12 / 2001

MALAGA SE 1235

MATERIAL-NR. / PART NO.: 926710151201
BESTELL-NR. / ORDER NO.: GMI9900

POS. NR. POS. NO.	ABB. FIG.	MATERIAL-NR. PART NUMBER	ANZ. QTY.	BEZEICHNUNG (D)	DESCRIPTION (GB)
		926710151201		MALAGA SE1235 KEIN E-TEIL	MALAGA SE1235 NO SPARE PART
0001.000	2	267210030101		GEH-OBERTEIL	TOP COVER
0004.000	2	267120220002		FRONTPLATTE SCHWARZ	FRONT PANEL BLACK
0009.000	2	267160020001	4	FUSS GUMMI	RUBBER FEET
0010.000	△ 2	267275000402	X	DVD-LAUFWERK DVD-KIT510LE KEIN E-TEIL	DVD-DRIVE DVD-KIT510LE NO SPARE PART
0011.000	2	267290880101	X	DVD-DIGITALPLATTE	DVD-DIGITAL BOARD
0012.000	△ 2	267270150101	X	DVD-NETZTEILPLATTE PSSH370603B	DVD-POWER SUPPLY PSSH370603B
0013.000	2	267290660101	X	DVD-ANALOGPLATTE KPL. KEIN E-TEIL	DVD-ANALOG BOARD ASSY NO SPARE PART
0014.000	2	267290650501	X	DVD-BEDIENPLATTE KPL. KEIN E-TEIL	DVD-CONTROL BOARD ASSY NO SPARE PART
0015.000	2	267170080101		ABDECKUNG SCHUBLADE	DRAWER COVER
0016.000	2	267260310001		FLEXIBLE LEITUNG 16POL	FLEXIBLE CABLE 16POL
0017.000	2	267260320001		FLEXIBLE LEITUNG 26POL	FLEXIBLE CABLE 26POL
0018.000	2	267260330001		FLEXIBLE LEITUNG 6POL	FLEXIBLE CABLE 6POL
0019.000	2	267260340001		FLEXIBLE LEITUNG 18POL	FLEXIBLE CABLE 18POL
0020.000	2	267260360001		FLEXIBLE LEITUNG 20POL	FLEXIBLE CABLE 20POL
0021.000	2	267260350001		FLEXIBLE LEITUNG 16POL	FLEXIBLE CABLE 16POL
0022.000	2	267140100002		TASTENLEISTE LINKS	BUTTON SET LEFT
0023.000	2	267140110002		TASTENLEISTE RECHTS	BUTTON SET RIGHT
0024.000	2	267140120001		KNOPF OK	BUTTON OK
0025.000	2	267130130002		FENSTER	WINDOW
0027.000	△	829099122000		NETZKABEL KPL	POWER CABLE CPL
0028.000		267280120201		TP 81 D FERNBEDIENUNG	TP 81 D REMOTE CONTROL
		275990172900		SOFTWARE UPGRADE CD-ROM	SOFTWARE UPGRADE CD-ROM
		267109415401		BEDIENUNGSANLEITUNG GB/CS/PL/HU	OPERATING INSTRUCTION GB/CS/PL/HU
		720105408500		SERVICE MANUAL D/GB	SERVICE MANUAL D/GB
		720105408600		SERVICE MANUAL D/GB 1.ERGAENZUNG	SERVICE MANUAL D/GB 1ST SUPPLEMENT
		720105408700		SERVICE MANUAL D/GB 2.ERGAENZUNG	SERVICE MANUAL D/GB 2ND SUPPLEMENT
				X = SIEHE GESONDERTE E-LISTE	X = SEE SEPARATE PARTS LIST

Es gelten die Vorschriften und Sicherheitshinweise gemäß dem Service Manual "Sicherheit", Mat.-Nummer 720108000000, sowie zusätzlich die eventuell abweichenden, landesspezifischen Vorschriften!



The regulations and safety instructions shall be valid as provided by the "Safety" Service Manual, part number 720108000000, as well as the respective national deviations.

ÄNDERUNGEN VORBEHALTEN / SUBJECT TO ALTERATION

Ersatzteilliste
Spare Parts List

DVD

12 / 2001

LAUFWERK KIT 510 LE
DRIVE MECHANISM KIT 510 LE

MATERIAL-NR. / PART NO.: 267275000402

POS. NR. POS. NO.	ABB. FIG.	MATERIAL-NR. PART NUMBER	ANZ. QTY.	BEZEICHNUNG (D)	DESCRIPTION (GB)
		267275000402		LAUFWERK KIT 510 LE MIT LAUFWERKPLATTE KEIN E-TEIL	DRIVE MECHANISM KIT 510 LE WITH DRIVE MECHANISM BOARD NO SPARE PART
		759880673400	X	LAUFWERKPLATTE KEIN E-TEIL	DRIVE BOARD NO SPARE PART
DM00007	1	759880665400		RIEMEN	BELT
DM00019	1	759880666900		LADEMOTOR	MOTOR LOADING
DM00020	1	759880671700		LP-SCHALTER MODUL	SWITCH BOARD C.B.A.
DM00022	1	759880672400		SCHUBLADE	TRAY
DM00023	1	759880673300		MECHANIK + LASEREINHEIT	MECHANISM+LASERUNIT
DM00038	1	759880670600		SLEDGEMOTOR	SLEDGEMOTOR
DM00041	1	759880671200		DAEMPfung	DAMPING
				X = SIEHE GESONDERTE E-LISTE	X = SEE SEPARATE PARTS LIST

Es gelten die Vorschriften und Sicherheitshinweise gemäß dem Service Manual "Sicherheit", Mat.-Nummer 720108000000, sowie zusätzlich die eventuell abweichenden, landesspezifischen Vorschriften!



The regulations and safety instructions shall be valid as provided by the "Safety" Service Manual, part number 720108000000, as well as the respective national deviations.

ÄNDERUNGEN VORBEHALTEN / SUBJECT TO ALTERATION

Ersatzteilliste
Spare Parts List

11 / 2001

GRUNDIG

DVD

LAUFWERKPLATTE
DRIVE BOARD

MATERIAL-NR. / PART NO.: 759880673400

POS. NR. POS. NO.	ABB. FIG.	MATERIAL-NR. PART NUMBER	ANZ. QTY.	BEZEICHNUNG (D)	DESCRIPTION (GB)
		759880673400		LAUFWERKPLATTE KEIN E-TEIL	DRIVE BOARD NO SAPRE PART

POS. NR. POS. NO.	MATERIAL-NR. PART NUMBER	BEZEICHNUNG DESCRIPTION	POS. NR. POS. NO.	MATERIAL-NR. PART NUMBER	BEZEICHNUNG DESCRIPTION
CN 00100	759880659100	SOCKEL 24P FPC	Q 05020	759880653500	TRANS 2SC2412K-R
CN 00610	759880669200	SOCKEL 11P FPC	X 02000	759880672200	QUARZ 16.9344 MHZ
D 01101	759880673900	DIODE KDS120E	X 05000	759880673800	QUARZ 16.0 MHZ
D 01102	759880674000	DIODE DAN222			
IC 00100	759880670300	IC LA9702WL-MPB			
IC 00101	759880659500	IC BU4066BCF			
IC 00200	759880673600	IC LC78661W-D			
IC 00201	759880671800	IC T224162B-35S			
IC 00500	759880673700	IC M37903S4CHP			
IC 00502	759880660800	IC M51953BFP			
IC 00504	759880660100	IC TC7SHU04FU			
IC 00550	759880673500	IC LE28C1001DTS-90-MPB			
IC 00601	759880672000	IC BA5937AFP			
IC 00602	759880659800	IC BA6849FP			
IC 00900	759880661500	IC BA033FP			
L 01002	759880661800	SPULE 1000 OHM			
L 01003	759880661800	SPULE 1000 OHM			
L 01004	759880661800	SPULE 1000 OHM			
L 01005	759880661800	SPULE 1000 OHM			
L 01006	759880661800	SPULE 1000 OHM			
L 02002	759880661800	SPULE 1000 OHM			
L 02003	759880662400	SPULE 1000 OHM			
L 09001	759880672100	SPULE 2.2 UH			
Q 01002	759880653500	TRANS 2SC2412K-R			
Q 01003	759880662300	TRANS 2SC1623-L6			
Q 01004	759880661900	TRANS 2SA1036K-R			
Q 01005	759880661900	TRANS 2SA1036K-R			
Q 01006	759880662300	TRANS 2SC1623-L6			
Q 01007	759880653600	TRANS 2SA1037K-R			
Q 01008	759880662300	TRANS 2SC1623-L6			
Q 01009	759880662300	TRANS 2SC1623-L6			
Q 01010	759880653600	TRANS 2SA1037K-R			
Q 01011	759880662300	TRANS 2SC1623-L6			
Q 01012	830165231800	SMD TRANS 2SK3018 ROHM			
Q 01013	830236614400	SMD TRANS DTC144EKA			
Q 01015	759880662300	TRANS 2SC1623-L6			
Q 01016	759880662300	TRANS 2SC1623-L6			
Q 01017	830165231800	SMD TRANS 2SK3018 ROHM			
Q 01018	830165231800	SMD TRANS 2SK3018 ROHM			

Es gelten die Vorschriften und Sicherheitshinweise gemäß dem Service Manual "Sicherheit", Mat.-Nummer 720108000000, sowie zusätzlich die eventuell abweichenden, landesspezifischen Vorschriften!



The regulations and safety instructions shall be valid as provided by the "Safety" Service Manual, part number 720108000000, as well as the respective national deviations.

ÄNDERUNGEN VORBEHALTEN / SUBJECT TO ALTERATION

GRUNDIG

DVD

Ersatzteilliste
Spare Parts List

12 / 2001

DVD-DIGITALPLATTE
DVD DIGITALBOARD

MATERIAL-NR. / PART NO.: 267290870101

POS. NR. POS. NO.	ABB. FIG.	MATERIAL-NR. PART NUMBER	ANZ. QTY.	BEZEICHNUNG (D)	DESCRIPTION (GB)
		267290870101		DVD-DIGITALPLATTE	DVD DIGITALBOARD

POS. NR. POS. NO.	MATERIAL-NR. PART NUMBER	BEZEICHNUNG DESCRIPTION	POS. NR. POS. NO.	MATERIAL-NR. PART NUMBER	BEZEICHNUNG DESCRIPTION
D1	832521205300	SMD-DIODE BAT54A	U5	830497454100	SMD IC 74VHCT541AMTC FAI
D2	832521205300	SMD-DIODE BAT54A	U6	830576636100	SMD IC LP3962-EMP-1.8 NS
D3	832521205300	SMD-DIODE BAT54A	U7	830596001600	SMD IC M24C16CM1TR/MN6T/
D4	830938404700	SMD-Z DIODE BZX 84 C4V7	U8	830477202300	SMD IC PANTERA NDV8602VWA
D5	830938404700	SMD-Z DIODE BZX 84 C4V7	U9	830470057400	SMD IC 74LCX574MTC FAI
J3	829017545000	LP-VERBINDER 20-POL FPC/F	U10	830470057400	SMD IC 74LCX574MTC FAI
J6	829017544600	LP-VERBINDER 16-POL FPC	U11	830579125700	SMD IC 74ACT257MTC FAI
J10	829017545600	LP-VERBINDER 26-POL FPC/F	U12	830470057300	SMD IC 74LCX573MTC FAI
J11	829017544600	LP-VERBINDER 16-POL FPC	U13/U15*	830470980100	FLASH XENARO 5XX/6XX
L1	814052980900	SMD DR 1210 400MA SBY3225	U14	830470057300	SMD IC 74LCX573MTC FAI
L2	814052980900	SMD DR 1210 400MA SBY3225	U19	830576470900	SMD IC L7809CD2T STM
L3	814052980900	SMD DR 1210 400MA SBY3225	U22	830467463200	SMD IC K4S643232-TG/L70
L4	814052980600	SMD DR 2.2UH 5% 1008NLV25	Y1	838233627200	QUARZ #336-1 13C 27MHZ 30
L5	814052980600	SMD DR 2.2UH 5% 1008NLV25			* MUEESSEN ZUSAMMEN GETAUSCHT WERDEN MUST BE REPLACED TOGETHER
L6	814052980600	SMD DR 2.2UH 5% 1008NLV25			
L7	814052980600	SMD DR 2.2UH 5% 1008NLV25			
L8	814052980900	SMD DR 1210 400MA SBY3225			
L12	814052981200	SMD DR 10UH 5% 1008NLV25T			
L13	814052980600	SMD DR 2.2UH 5% 1008NLV25			
L14	814052980600	SMD DR 2.2UH 5% 1008NLV25			
L15	814052980600	SMD DR 2.2UH 5% 1008NLV25			
L16	814052980600	SMD DR 2.2UH 5% 1008NLV25			
L17	814052980600	SMD DR 2.2UH 5% 1008NLV25			
L21	814052981200	SMD DR 10UH 5% 1008NLV25T			
Q1	830100785700	SMD TRANS BC857			
Q2	830100784700	SMD TRANS BC847			
Q4	830100784700	SMD TRANS BC847			
Q5	830100784700	SMD TRANS BC847			
Q6	830100784700	SMD TRANS BC847			
Q7	830100784700	SMD TRANS BC847			
Q9	830100784700	SMD TRANS BC847			
Q13	830100784700	SMD TRANS BC847			
RP1	877003403700	SMD R-NETZ 1206 4X33 OHM			
RP4	877003403700	SMD R-NETZ 1206 4X33 OHM			
RP6	877003403700	SMD R-NETZ 1206 4X33 OHM			
U2	830487872000	SMD IC WM8720EDS WOLFSON			
U3	830575983400	SMD IC LM833M NSC			

Es gelten die Vorschriften und Sicherheitshinweise gemäß dem Service Manual "Sicherheit", Mat.-Nummer 720108000000, sowie zusätzlich die eventuell abweichenden, landesspezifischen Vorschriften!



The regulations and safety instructions shall be valid as provided by the "Safety" Service Manual, part number 720108000000, as well as the respective national deviations.

ÄNDERUNGEN VORBEHALTEN / SUBJECT TO ALTERATION

Ersatzteilliste
Spare Parts List

DVD

12 / 2001

DVD-DIGITALPLATTE
DVD DIGITALBOARD

MATERIAL-NR. / PART NO.: 267290880101

POS. NR. POS. NO.	ABB. FIG.	MATERIAL-NR. PART NUMBER	ANZ. QTY.	BEZEICHNUNG (D)	DESCRIPTION (GB)
----------------------	--------------	-----------------------------	--------------	--------------------	---------------------

267290880101

DVD-DIGITALBOARD

DVD DIGITALBOARD

POS. NR. POS. NO.	MATERIAL-NR. PART NUMBER	BEZEICHNUNG DESCRIPTION	POS. NR. POS. NO.	MATERIAL-NR. PART NUMBER	BEZEICHNUNG DESCRIPTION
D1	832521205300	SMD-DIODE BAT54A	U6	830576636100	SMD IC LP3962-EMP-1.8 NS
D2	832521205300	SMD-DIODE BAT54A	U7	830596001600	SMD IC M24C16CM1TR-MN6T/
D3	832521205300	SMD-DIODE BAT54A	U8	830477202300	SMD IC PANTERA NDV8602VWA
D4	830938404700	SMD-Z DIODE BZX 84 C4V7	U9	830470057400	SMD IC 74LCX574MTC FAI
D5	830938404700	SMD-Z DIODE BZX 84 C4V7	U10	830470057400	SMD IC 74LCX574MTC FAI
J3	829017545000	LP-VERBINDER 20-POL FPC/F	U11	830579125700	SMD IC 74ACT257MTC FAI
J6	829017544600	LP-VERBINDER 16-POL FPC	U12	830470057300	SMD IC 74LCX573MTC FAI
J10	829017545600	LP-VERBINDER 26-POL FPC/F	U13/U15*	830470980100	FLASH XENARO 5XX/6XX
J11	829017544600	LP-VERBINDER 16-POL FPC	U14	830470057300	SMD IC 74LCX573MTC FAI
L2	814052980900	SMD DR 1210 400MA SBY3225	U19	830576470900	SMD IC L7809CD2T STM
L4	814052980600	SMD DR 2,2UH 5% 1008NLV25	U22	830467463200	SMD IC K4S643232-TC/L70
L5	814052980600	SMD DR 2,2UH 5% 1008NLV25	Y1	838233627200	QUARZ #336-1 13C 27MHZ 30
L6	814052980600	SMD DR 2,2UH 5% 1008NLV25			
L7	814052980600	SMD DR 2,2UH 5% 1008NLV25			
L8	814052980900	SMD DR 1210 400MA SBY3225			
L10	814052498400	SIEB-DR 39UH 10% LHL08 T			
L11	814052498400	SIEB-DR 39UH 10% LHL08 T			
L13	814052980600	SMD DR 2,2UH 5% 1008NLV25			
L14	814052980600	SMD DR 2,2UH 5% 1008NLV25			
L15	814052980600	SMD DR 2,2UH 5% 1008NLV25			
L16	814052980600	SMD DR 2,2UH 5% 1008NLV25			
L17	814052980600	SMD DR 2,2UH 5% 1008NLV25			
L21	814052981200	SMD DR 10UH 5% 1008NLV25T			
Q1	830100785700	SMD TRANS BC857			
Q2	830100784700	SMD TRANS BC847			
Q4	830100784700	SMD TRANS BC847			
Q5	830100784700	SMD TRANS BC847			
Q6	830100784700	SMD TRANS BC847			
Q7	830100784700	SMD TRANS BC847			
Q9	830100784700	SMD TRANS BC847			
Q13	830100784700	SMD TRANS BC847			
RP1	877003403700	SMD R-NETZ 1206 4X33 OHM			
RP4	877003403700	SMD R-NETZ 1206 4X33 OHM			
RP6	877003403700	SMD R-NETZ 1206 4X33 OHM			
U2	830487872000	SMD IC WM8720EDS WOLFSON			
U3	830575983400	SMD IC LM833M NSC			
U5	830497454100	SMD IC 74VHCT541AMTC FAI			

* MUESSEN ZUSAMMEN GETAUSCHT WERDEN
MUST BE REPLACED TOGETHEREs gelten die Vorschriften und Sicherheitshinweise
gemäß dem Service Manual "Sicherheit", Mat.-Num-
mer 720108000000, sowie zusätzlich die eventuell ab-
weichenden, landesspezifischen Vorschriften!The regulations and safety instructions shall be valid
as provided by the "Safety" Service Manual, part
number 720108000000, as well as the respective
national deviations.

ÄNDERUNGEN VORBEHALTEN / SUBJECT TO ALTERATION

Ersatzteilliste
Spare Parts List

DVD

12 / 2001

DVD-DIGITALPLATTE
DVD-DIGITALBOARD

MATERIAL-NR. / PART NO.: 267290890101

POS. NR. POS. NO.	ABB. FIG.	MATERIAL-NR. PART NUMBER	ANZ. QTY.	BEZEICHNUNG (D)	DESCRIPTION (GB)
----------------------	--------------	-----------------------------	--------------	--------------------	---------------------

267290890101

DVD DIGITALPLATTE

DVD DIGITALBOARD

POS. NR. POS. NO.	MATERIAL-NR. PART NUMBER	BEZEICHNUNG DESCRIPTION	POS. NR. POS. NO.	MATERIAL-NR. PART NUMBER	BEZEICHNUNG DESCRIPTION
D1	832521205300	SMD-DIODE BAT54A	R132	870606423800	SMD R 0603 2,49 OHM 1% AV
D2	832521205300	SMD-DIODE BAT54A	RP1	877003403700	SMD R-NETZ 1206 4X33 OHM
D3	832521205300	SMD-DIODE BAT54A	RP4	877003403700	SMD R-NETZ 1206 4X33 OHM
D4	830938404700	SMD-Z DIODE BZX 84 C4V7	RP6	877003403700	SMD R-NETZ 1206 4X33 OHM
D5	830938404700	SMD-Z DIODE BZX 84 C4V7	RP8	877003403700	SMD R-NETZ 1206 4X33 OHM
D9	830931307000	SMD-DIODE BAV70	RP9	877003403700	SMD R-NETZ 1206 4X33 OHM
J3	829017545000	LP-VERBINDER 20-POL FPC/F	RP12	877003403700	SMD R-NETZ 1206 4X33 OHM
J6	829017544600	LP-VERBINDER 16-POL FPC	U1	830487872100	SMD IC WM8721EDS WOLFSON
J7	829017545000	LP-VERBINDER 20-POL FPC/F	U3	830575983400	SMD IC LM833M NSC
J10	829017545600	LP-VERBINDER 26-POL FPC/F	U5	830497454100	SMD IC 74VHCT541AMTC FAI
J11	829017544600	LP-VERBINDER 16-POL FPC	U6	830576636100	SMD IC LP3962-EMP-1.8 NS
L1	814052980900	SMD DR 1210 400MA SBY3225	U7	830596001600	SMD IC M24C16CM1TR-MN6T/
L2	814052980900	SMD DR 1210 400MA SBY3225	U8	830477202500	SMD IC PANTERA NDV8601VWA
L3	814052980900	SMD DR 1210 400MA SBY3225	U9	830470057400	SMD IC 74LCX574MTC FAI
L4	814052980600	SMD DR 2,2UH 5% 1008NLV25	U10	830470057400	SMD IC 74LCX574MTC FAI
L5	814052980600	SMD DR 2,2UH 5% 1008NLV25	U11	830579125700	SMD IC 74ACT257MTC FAI
L6	814052980600	SMD DR 2,2UH 5% 1008NLV25	U12	830470057300	SMD IC 74LCX573MTC FAI
L7	814052980600	SMD DR 2,2UH 5% 1008NLV25	U13/U15*	830470980100	FLASH XENARO 5XX/6XX
L10	814052498400	SIEB-DR 39UH 10% LHL08 T	U14	830470057300	SMD IC 74LCX573MTC FAI
L11	814052498400	SIEB-DR 39UH 10% LHL08 T	U19	830576470900	SMD IC L7809CD2T STM
L12	814052981200	SMD DR 10UH 5% 1008NLV25T	U22	830467463200	SMD IC K4S643232-TC/L70
L13	814052980600	SMD DR 2,2UH 5% 1008NLV25	Y1	838233627200	QUARZ #336-1 13C 27MHZ 30
L14	814052980600	SMD DR 2,2UH 5% 1008NLV25			
L15	814052980600	SMD DR 2,2UH 5% 1008NLV25			
L16	814052980600	SMD DR 2,2UH 5% 1008NLV25			
L17	814052980600	SMD DR 2,2UH 5% 1008NLV25			
L21	814052981200	SMD DR 10UH 5% 1008NLV25T			
Q1	830100785700	SMD TRANS BC857			
Q2	830100784700	SMD TRANS BC847			
Q3	830140250200	SMD TRANS FET IRLML2502			
Q4	830100784700	SMD TRANS BC847			
Q5	830100784700	SMD TRANS BC847			
Q6	830100784700	SMD TRANS BC847			
Q8	830100784700	SMD TRANS BC847			
Q9	830100784700	SMD TRANS BC847			
Q10	830100785700	SMD TRANS BC857			
Q11	830100784700	SMD TRANS BC847			
Q12	830100784700	SMD TRANS BC847			
Q13	830100784700	SMD TRANS BC847			

* MUESSEN ZUSAMMEN GETAUSCHT WERDEN
MUST BE REPLACED TOGETHEREs gelten die Vorschriften und Sicherheitshinweise
gemäß dem Service Manual "Sicherheit", Mat.-Num-
mer 720108000000, sowie zusätzlich die eventuell ab-
weichenden, landesspezifischen Vorschriften!The regulations and safety instructions shall be valid
as provided by the "Safety" Service Manual, part
number 720108000000, as well as the respective
national deviations.

ÄNDERUNGEN VORBEHALTEN / SUBJECT TO ALTERATION