

51AM-12S
54AM-12S
51AT-15S
54AT-15S

SHARP

SERVICE MANUAL

SEJK54AT15S4/

5BS-A - CHASSIS

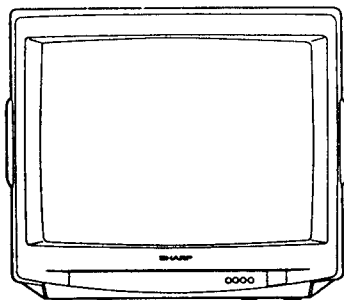

51AM-12S
51AT-15S

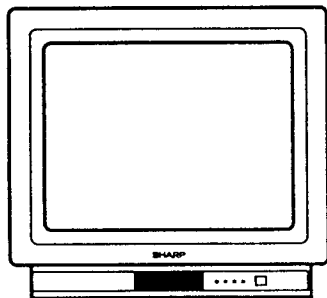

54AM-12S
54AT-15S

PAL SYSTEM COLOUR TELEVISION

51AM-12S

54AM-12S

51AT -15S

54AT -15S

MODELS

In the interests of user-safety (required by safety regulations in some countries) the set should be restored to its original condition and only parts identical to those specified should be used.

SERVICE ADJUSTMENT

■ SERVICE MODE FUNCTION

This mode function is provided to assist with the settings of those adjustments that may vary from one Picture Tube to another, or between models.

In order to use the Service Mode

1. Press main switch to OFF.
2. Connect Test Pattern signal to antenna terminal.
3. Press ∇ \triangleleft and CH \wedge buttons and main switch to ON simultaneously.
4. —SERV— will appear on screen. Service mode is now entered.
5. Select adjustment using buttons \wedge CH ∇ .

To exit service mode, press main switch to OFF or press MODE button on R/C.

| | Displayed on Screen | Hexadecimal Range | Function |
|----|---------------------|-------------------|--|
| | —SERV— | | Indicates operative Service Mode. |
| a. | AGC | 00 ~ FF | Auto Gain Control. |
| b. | AFT | 00 ~ FF | Auto Frequency Control |
| c. | BL PHA | 00 ~ 3F | Blanking Pulse shift. |
| d. | VER PO | 00 ~ 3F | Vertical Position shift. |
| e. | VER AM | 00 ~ 3F | Vertical Amplitude shift. |
| f. | VER SM | 00 ~ 3F | Vertical Symmetry alteration. |
| g. | LUMA-D | 00 ~ 05 | Luma Delay |
| h. | GII | | Indication of G2 adjustment. |
| i. | V-B-CO | 00 ~ 3F | Vertical Breathing Correction (DON'T TOUCH). |
| j. | GAIN R | 00 ~ 3F | Red Gain. |
| k. | GAIN G | 00 ~ 3F | Green Gain. |
| l. | GAIN B | 00 ~ 3F | Blue Gain. |
| m. | NVM | | Access to NVM memory. |

6. For "a" thru "l" selections.

Adjustment to a selection can be made by pressing buttons \wedge \triangleleft ∇ . (Not for GII adjustment).

A colour bar is displayed on the OSD to indicate the adjustment position, together with hexadecimal numbers (Not for GII adjustment).

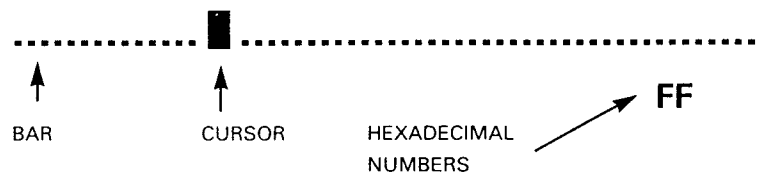

For "m" Selection.

NVM storage location settings variants.

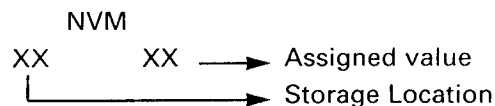

In order to have access to the desired storage location, buttons \wedge \triangleleft ∇ should be pressed, as required, to obtain a higher or lower location, respectively. Bear in mind that, for storage location indication a hexadecimal numerical system is used, instead of a decimal system.

0, 1, 2, 3, 4, 5, 6, 7, 8, 9, A, B, C, D, E, F, 10, 11, 19, 1A, 1B, 1C, 1D, 1E, 1F, 20, 21, 99, 9A, 9B, 9C, 9D, 9E, 9F, A0, A1,; B0, C0, D0, E0, F0, F1, F2, F3, F4, F5, F6, F7, F8, F9, FA, FB, FC, FD, FE, FF.

From the last location FF to the first 00 can be reached by increasing and from first to last by decreasing. Once the storage location to be varied has been selected, its value can be modified by the bits that form part of the storage location numerical buttons, numbers $\boxed{0}$ to $\boxed{7}$, respectively. This switches its binary number from and between 0 and 1 each time one of the buttons is pressed.

$$\boxed{0} = 2^0 = 1, \quad \boxed{1} = 2^1 = 2, \quad \boxed{2} = 2^2 = 4, \dots$$

NVM MAP

| ADD (HEX) | DESCRIPTION | | | | | | | | | | | | | | | | |
|-----------|---|---------|-----|-----|--------|------|--------|------|----|---|---|---|---|---|---|---|---|
| 00 | RED COLOUR TEMPERATURE | | | | | | | | | | | | | | | | |
| 01 | GREEN COLOUR TEMPERATURE | | | | | | | | | | | | | | | | |
| 02 | BLUE COLOUR TEMPERATURE | | | | | | | | | | | | | | | | |
| 03 | VERTICAL POSITION | | | | | | | | | | | | | | | | |
| 04 | HORIZONTAL PHASE CONTROL | | | | | | | | | | | | | | | | |
| 05 | VERTICAL AMPLITUDE | | | | | | | | | | | | | | | | |
| 06 | VERTICAL BREATHING CORRECTION | | | | | | | | | | | | | | | | |
| 07 | VERTICAL LINEARITY | | | | | | | | | | | | | | | | |
| 08 | LUMA DELAY PAL | | | | | | | | | | | | | | | | |
| 09 | LUMA DELAY SECAM | | | | | | | | | | | | | | | | |
| 0A | AGC | | | | | | | | | | | | | | | | |
| 0B | <p>OPTIONS:</p> <table border="1" style="margin-left: auto; margin-right: auto;"> <tr> <td style="text-align: center;">ING_OSD</td> <td style="text-align: center;">A_F</td> <td style="text-align: center;">CHL</td> <td style="text-align: center;">PAL</td> <td style="text-align: center;">UHF</td> <td style="text-align: center;">T_LOCK</td> <td style="text-align: center;">AV_F</td> <td style="text-align: center;">FP</td> </tr> <tr> <td style="text-align: center;">7</td> <td style="text-align: center;">6</td> <td style="text-align: center;">5</td> <td style="text-align: center;">4</td> <td style="text-align: center;">3</td> <td style="text-align: center;">2</td> <td style="text-align: center;">1</td> <td style="text-align: center;">0</td> </tr> </table> <p>0: FP: SYSTEM B/G (0) - B/G+L, MESSAGE RECHERCHE (1) 1: AV FRONTAL: NOT INCLUDED (0), INCLUDED (1) 2: TUNING LOCK: LOCKED (1), NOT LOCKED (0) 3: UHF ONLY: BAND UHF (1) - ALL BANDS (0) 4: PAL ONLY (1), PAL+SECAM (0) 5: CHILD LOCK: CHILD LOCK ACTIVE (1) CHILD LOCK NO ACT (0) 6: AUTO FIRST: TUNING FIRST MENU: AUTO (1) MANUAL (0) 7: ING_OSD: OSD_INGLES (1) OSD_SYMBOL (0)</p> | ING_OSD | A_F | CHL | PAL | UHF | T_LOCK | AV_F | FP | 7 | 6 | 5 | 4 | 3 | 2 | 1 | 0 |
| ING_OSD | A_F | CHL | PAL | UHF | T_LOCK | AV_F | FP | | | | | | | | | | |
| 7 | 6 | 5 | 4 | 3 | 2 | 1 | 0 | | | | | | | | | | |
| 0C | AFT ADJUSTMENT VALUE (B/G, L SYSTEMS) | | | | | | | | | | | | | | | | |
| 0D | AFT ADJUSTMENT VALUE (L' SYSTEM) | | | | | | | | | | | | | | | | |
| 0E | MAXIMUM VOLUME LIMIT | | | | | | | | | | | | | | | | |
| 0F | FIRM | | | | | | | | | | | | | | | | |
| 10 | RED COLOUR TEMPERATURE | | | | | | | | | | | | | | | | |
| 11 | GREEN COLOUR TEMPERATURE | | | | | | | | | | | | | | | | |
| 12 | BLUE COLOUR TEMPERATURE | | | | | | | | | | | | | | | | |
| 13 | VERTICAL POSITION | | | | | | | | | | | | | | | | |
| 14 | HORIZONTAL PHASE CONTROL | | | | | | | | | | | | | | | | |
| 15 | VERTICAL AMPLITUDE | | | | | | | | | | | | | | | | |
| 16 | VERTICAL BREATHING CORRECTION | | | | | | | | | | | | | | | | |
| 17 | VERTICAL LINEARITY | | | | | | | | | | | | | | | | |

| ADD (HEX) | DESCRIPTION | | | | | | | | | | | | | | | | |
|-----------|---|---------|-----|-----|--------|------|--------|------|----|---|---|---|---|---|---|---|---|
| 18 | LUMA DELAY PAL | | | | | | | | | | | | | | | | |
| 19 | LUMA DELAY SECAM | | | | | | | | | | | | | | | | |
| 1A | AGC | | | | | | | | | | | | | | | | |
| 1B | <p>OPTIONS:</p> <table border="1" style="margin-left: auto; margin-right: auto;"> <tr> <td>ING_OSD</td> <td>A_F</td> <td>CHL</td> <td>PAL</td> <td>UHF</td> <td>T_LOCK</td> <td>AV_F</td> <td>FP</td> </tr> <tr> <td style="text-align: center;">7</td> <td style="text-align: center;">6</td> <td style="text-align: center;">5</td> <td style="text-align: center;">4</td> <td style="text-align: center;">3</td> <td style="text-align: center;">2</td> <td style="text-align: center;">1</td> <td style="text-align: center;">0</td> </tr> </table> <p>0: FP: SYSTEM B/G (0) - B/G+L, MESSAGE RECHERCHE (1) 1: AV FRONTAL: NOT INCLUDED (0), INCLUDED (1) 2: TUNING LOCK: LOCKED (1), NOT LOCKED (0) 3: UHF_ONLY: BAND UHF (1) - ALL BANDS (0) 4: PAL ONLY (1), PAL+SECAM (0) 5: CHILD LOCK: CHILD LOCK ACTIVE (1) CHILD LOCK NO ACT (0) 6: AUTO FIRST: TUNING FIRST MENU: AUTO (1) MANUAL (0) 7: ING_OSD: OSD_INGLES (1) OSD_SYMBOL (0)</p> | ING_OSD | A_F | CHL | PAL | UHF | T_LOCK | AV_F | FP | 7 | 6 | 5 | 4 | 3 | 2 | 1 | 0 |
| ING_OSD | A_F | CHL | PAL | UHF | T_LOCK | AV_F | FP | | | | | | | | | | |
| 7 | 6 | 5 | 4 | 3 | 2 | 1 | 0 | | | | | | | | | | |
| 1C | AFT ADJUSTMENT VALUE (B/G, L SYSTEMS) | | | | | | | | | | | | | | | | |
| 1D | AFT ADJUSTMENT VALUE (L' SYSTEM) | | | | | | | | | | | | | | | | |
| 1E | MAXIMUM VOLUME LIMIT | | | | | | | | | | | | | | | | |
| 1F | FIRM | | | | | | | | | | | | | | | | |
| 20 | RED COLOUR TEMPERATURE | | | | | | | | | | | | | | | | |
| 21 | GREEN COLOUR TEMPERATURE | | | | | | | | | | | | | | | | |
| 22 | BLUE COLOUR TEMPERATURE | | | | | | | | | | | | | | | | |
| 23 | VERTICAL POSITION | | | | | | | | | | | | | | | | |
| 24 | HORIZONTAL PHASE CONTROL | | | | | | | | | | | | | | | | |
| 25 | VERTICAL AMPLITUDE | | | | | | | | | | | | | | | | |
| 26 | VERTICAL BREATHING CORRECTION | | | | | | | | | | | | | | | | |
| 27 | VERTICAL LINEARITY | | | | | | | | | | | | | | | | |
| 28 | LUMA DELAY PAL | | | | | | | | | | | | | | | | |
| 29 | LUMA DELAY SECAM | | | | | | | | | | | | | | | | |
| 2A | AGC | | | | | | | | | | | | | | | | |
| 2B | <p>OPTIONS:</p> <table border="1" style="margin-left: auto; margin-right: auto;"> <tr> <td>ING_OSD</td> <td>A_F</td> <td>CHL</td> <td>PAL</td> <td>UHF</td> <td>T_LOCK</td> <td>AV_F</td> <td>FP</td> </tr> <tr> <td style="text-align: center;">7</td> <td style="text-align: center;">6</td> <td style="text-align: center;">5</td> <td style="text-align: center;">4</td> <td style="text-align: center;">3</td> <td style="text-align: center;">2</td> <td style="text-align: center;">1</td> <td style="text-align: center;">0</td> </tr> </table> <p>0: FP: SYSTEM B/G (0) - B/G+L, MESSAGE RECHERCHE (1) 1: AV FRONTAL: NOT INCLUDED (0), INCLUDED (1) 2: TUNING LOCK: LOCKED (1), NOT LOCKED (0) 3: UHF_ONLY: BAND UHF (1) - ALL BANDS (0) 4: PAL ONLY (1), PAL+SECAM (0) 5: CHILD LOCK: CHILD LOCK ACTIVE (1) CHILD LOCK NO ACT (0) 6: AUTO FIRST: TUNING FIRST MENU: AUTO (1) MANUAL (0) 7: ING_OSD: OSD_INGLES (1) OSD_SYMBOL (0)</p> | ING_OSD | A_F | CHL | PAL | UHF | T_LOCK | AV_F | FP | 7 | 6 | 5 | 4 | 3 | 2 | 1 | 0 |
| ING_OSD | A_F | CHL | PAL | UHF | T_LOCK | AV_F | FP | | | | | | | | | | |
| 7 | 6 | 5 | 4 | 3 | 2 | 1 | 0 | | | | | | | | | | |

| ADD (HEX) | DESCRIPTION |
|-----------|---------------------------------------|
| 2C | AFT ADJUSTMENT VALUE (B/G, L SYSTEMS) |
| 2D | AFT ADJUSTMENT VALUE (L' SYSTEM) |
| 2E | MAXIMUM VOLUME LIMIT |
| 2F | FIRM |
| 30 | TABLE LONG |
| 31 | FIRM |
| 32 | AGING ON. AUTOMATIC SWITCH ON. |
| 33 | SWITCH ON DELAY TIME |
| 34 | VOLUME |
| 35 | CONTRAST |
| 36 | COLOUR |
| 37 | BRIGHTNESS |
| 38 | PEAKING (RANGE: 1-7) |
| 39 | ACTUAL PROGRAMM |
| 3A | TV STATE ON/OFF |
| 3B | DECIMAL VOLUME VALUE (FACTORY PRESET) |
| 3C | CONTRAST (FACTORY PRESET) |
| 3D | COLOUR (FACTORY PRESET) |
| 3E | BRIGHTNESS (FACTORY PRESET) |
| 3F | PEAKING (RANGE: 0-7) (FACTORY PRESET) |
| 40 | ON TIMER LAST VALUE |
| 41 | OFF TIMER LAST VALUE |

| ADD (HEX) | DESCRIPTION |
|-----------------------------------|---|
| 42-B9 | PROGRAMS |
| BA (51AM-12S) (54AM-12S) | OSD STATE (X,X,X,X,X, CHILD_FRONT, CHILD_AV, NORM ON/OFF) |
| BA (51AT-15S) (54AT-15S) | OSD STATE BIT 0: PICTURE NORM ON/OFF BIT 1: SCART/AV LOCKED BIT 2: FRONTAL LOCKED BIT 3: ROW 8/30 PERMISS (PROGRAMMED INTERNALLY) BIT 4: PIN NUMBER OPTION (0-NOT APPEAR, 1-APPEAR) BIT 5: CLOCK STATE (PROGRAMMED INTERNALLY) BIT 6: ELIMINATE VERTICAL WHITE BARS IN MENUS BIT 7: X |
| BB | BKGD USER'S CORRECTION (NOT USED IN THIS MODEL) |
| BC | BKGD USER'S CORRECTION PRESET VALUE (NORMALIZED) (") |
| BD | VOLTAGE LIMIT BETWEEN L'-L SYSTEMS (MSB) |
| BE | VOLTAGE LIMIT BETWEEN L'-L SYSTEMS (LSB) |
| BF (51AM-12S) (54AM-12S) | HORIZONTAL OSD OFFSET |
| BF (51AT-15S) (54AT-15S) | HORIZONTAL OSD OFFSET BIT 7: DIRECTION SIGN: (0) INCREASE (1) DECREASE BIT 6: DON'T CARE BIT 5 - BIT 0: OFFSET VALUE |
| C0 | PROG SEARCH SPEED (ALL BANDS) -HIGH NIBBLE COMPLEMENTED- |
| C1 | PROG SEARCH SPEED (UHF BAND) -HIGH NIBBLE COMPLEMENTED- |
| C2 | PROG SEARCH SPEED (VHL BAND) -HIGH NIBBLE COMPLEMENTED- |
| C3 | PROG SEARCH SPEED (VHH BAND) -HIGH NIBBLE COMPLEMENTED- |
| C4 | CHANNEL RANGE IN FACTORY AUTOINSTALL |
| C5 | PASSWORD ON(1)/OFF(0) |
| C6 | PASSWORD FIRST DIGIT |
| C7 | PASSWORD SECOND DIGIT |
| C8 | PASSWORD THIRD DIGIT |
| C9 | PASSWORD FOURTH DIGIT |
| CA-CF | FREE |
| DO-FF (51AM-12S) (54AM-12S) | FREE |
| DO-FF (51AT-15S) (54AT-15S) | LIST STORED PAGES (8 PROGRAMS) (6 BYTES PER PROGRAM) |

7. The changes introduced are automatically memorized.

8. Having finalized adjustments, push MODE button on R/C to exit Service Mode.

■ PIF / AGC Adjustment

1. VCO + AFT Adjustment

1. Connect the output of SSG (Standard Signal Generator) to the tuner IF output terminal.
 - SSG output: 38.9 MHz (CW) ± 5 kHz).
 - SSG output level: approx. 90 dB μ V.
2. Enter into Service Mode.
3. Push CH \wedge until AFT appears.
4. Press \square / \rightarrow button on R/C. Setting is made automatically. During this setting the colour bar shall go from red to yellow. When setting is finished, colour bar disappears and B-STOP (bus stop) is shown on screen.
5. Switch set OFF and ON again, setting is now memorized.

2. RF-AGC Cut-In Adjustment (I2C BUS)

1. Receive the "COLOUR BAR" signal (Channel E-12).
 - Signal strength: 57 dB μ V. (51AM-12S/54AM-12S)
 - 55 dB μ V. (51AT-15S / 54AT-15S)
2. Enter into Service Mode.
3. Push CH \wedge until AGC appears.
4. Press \square / \rightarrow button on R/C. Setting is made automatically. During this setting the colour bar shall go from red to yellow. When setting is finished, colour bar disappears and B-STOP (bus stop) is shown on screen.
5. Switch set OFF and ON again, setting is now memorized.

■ Screen Adjustment

3. Focus Adjustment

1. Apply mains voltage of 220 V AC/50 Hz to TV.
2. Receive Phillips pattern signal to a level between 60 and 80 dB μ V.
3. Set contrast to 10/10, brightness to 5/10 and colour 0/10.
4. Adjust focus potentiometer to obtain maximum definition.

4. G2 Adjustment

1. Apply mains voltage of 220 V AC/50 Hz to TV.
2. Receive black screen signal to a level between 60 and 80 dB μ V.
3. Set contrast to 10/10, brightness to 0/10 and colour 0/10.
4. Enter into Service Mode.
5. Push CH \wedge until GII appears.
6. Increase G2 potentiometer until flyback appears on screen, and OSD bar is at maximum.
7. Adjust G2 potentiometer until OSD bar is at half way position on screen.
8. Exit Service Mode.

■ CHILD LOCK CANCEL (only for 51AT-15S/54AT-15S)

The following process describes how to cancel actual password (PIN) when the customer forgets code.

1. Switch ON TV set.
2. Press buttons \vee \triangleleft on TV and \square / \rightarrow on R/C simultaneously.
3. Press MODE button on R/C to input menu.
4. Using buttons \wedge CH \vee move to \rightarrow position.
5. Press MODE button again.
6. Select PIN and input new PIN (Please do not forget it)
7. Select EXIT and press MODE button again.

■ GEOMETRY ADJUSTMENT PROCEDURE

1. "BL PHA"

- Receive Philips pattern signal.
- When $\triangleleft \wedge$ button is pressed, picture moves to the left.
- When $\triangleleft \vee$ button is pressed, picture moves to the right.
- Adjust the horizontal location to obtain picture centering (fig. 1).

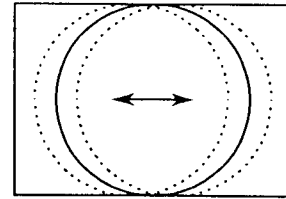

Fig. 1

2. "VER PO"

- Receive Philips pattern signal.
- When $\triangleleft \wedge$ button is pressed, picture moves up.
- When $\triangleleft \vee$ button is pressed, picture moves down.
- Adjust the horizontal location to obtain picture centering (fig. 2).

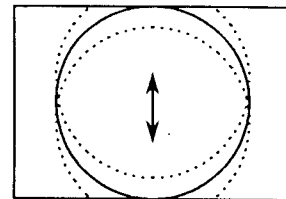

Fig. 2

3. "VER AM"

- Receive Philips pattern signal.
- When $\triangleleft \wedge$ button is pressed, vertical size of picture increases.
- When $\triangleleft \vee$ button is pressed, vertical size of picture decreases.
- Adjust the vertical size to obtain overscan (fig. 3).

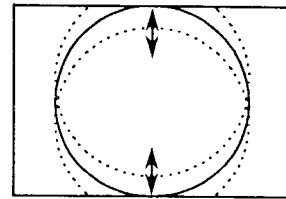

Fig. 3

4. "VER SM"

- Receive Philips pattern signal.
- When $\triangleleft \wedge$ button is pressed, upper picture scanning decreases and lower picture scanning increases.
- When $\triangleleft \vee$ button is pressed, upper picture scanning increases and lower picture scanning decreases.
- Adjust the vertical symmetry to obtain symmetrical scanning between upper and lower picture (fig. 4).

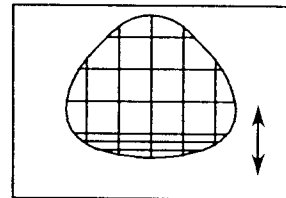

Fig. 4

COLOUR ADJUSTMENT

5. "LUMA D"

- Receive Philips pattern signal.
- When $\triangleleft \wedge$ button is pressed, luma phase delays.
- When $\triangleleft \vee$ button is pressed, chroma phase delays.
- Adjust the chroma-luma delay.

The following adjustments are only required when the Picture Tube is changed.

6. "GAIN R", "GAIN G", "GAIN B"

- Adjust G2.
- Tune in white card.
- Adjust colour to minimum.
- Position colourmeter in the center of screen.
- Using brightness and contrast buttons, select a luminance of ≈ 120 nits.
- Operate again in Service Mode and select location GAIN R, GAIN G, GAIN B to obtain colour coordinates:

$$X = 0.290 \pm 0.015$$

$$Y = 0.284 \pm 0.015$$

- Exit Service Mode and check colour coordinates 'X' and 'Y' at 20 and 120 NITS. It may be necessary to repeat procedure.

NOTE:

Locations: GAIN R alter 'X' coordinate; GAIN G alter the 'Y' coordinates; GAIN B alter the 'X' and 'Y' coordinates.

AC 250V - 240V 50 Hz
SACCE24908W5A

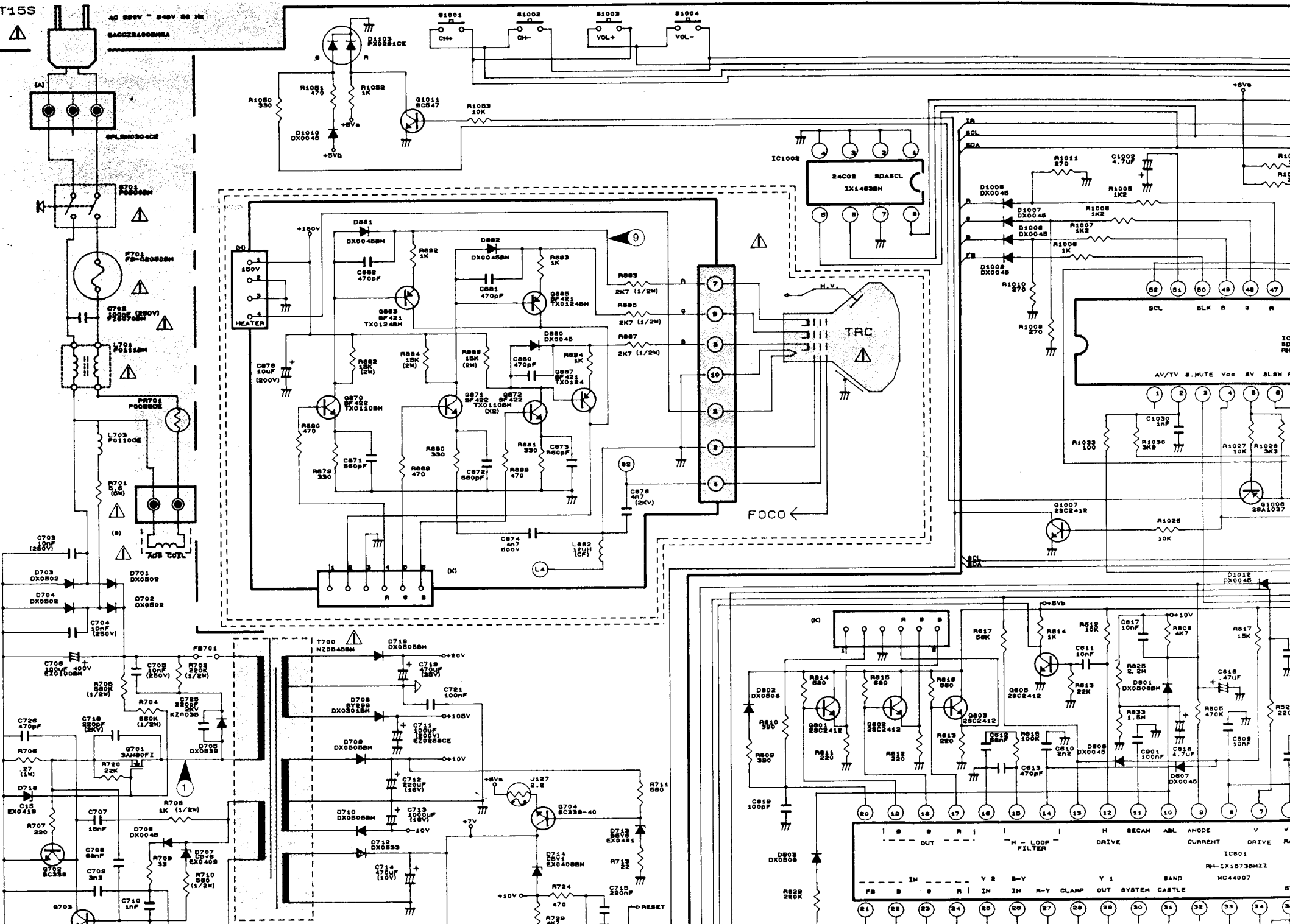

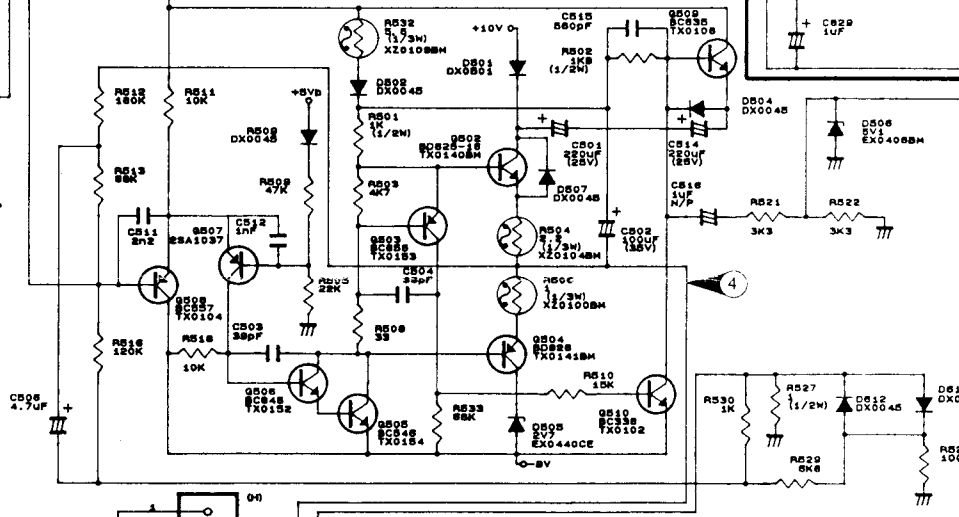
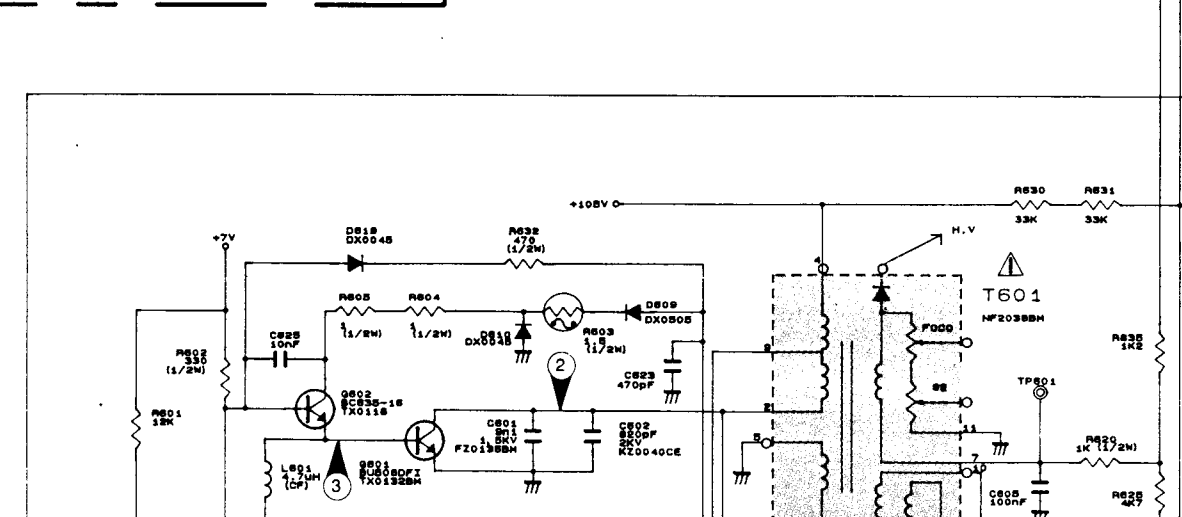
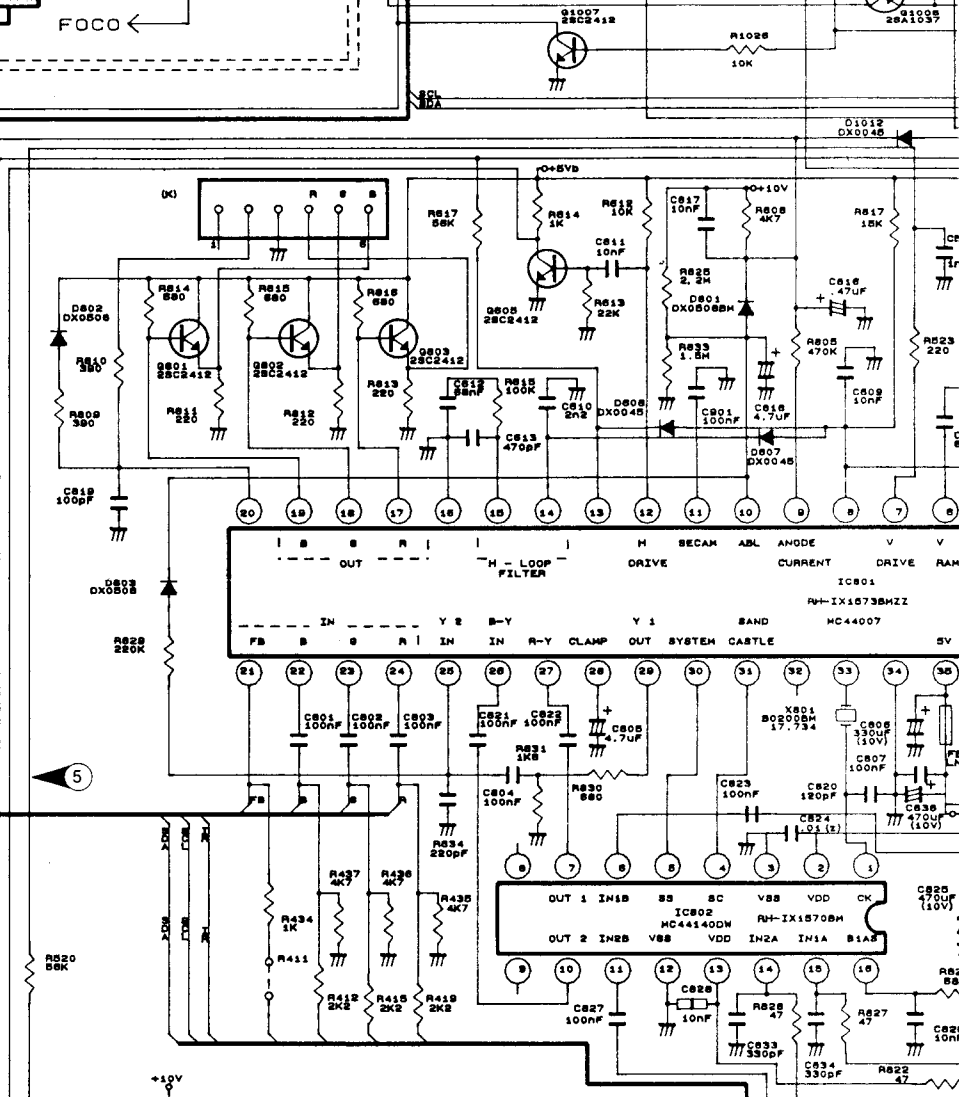
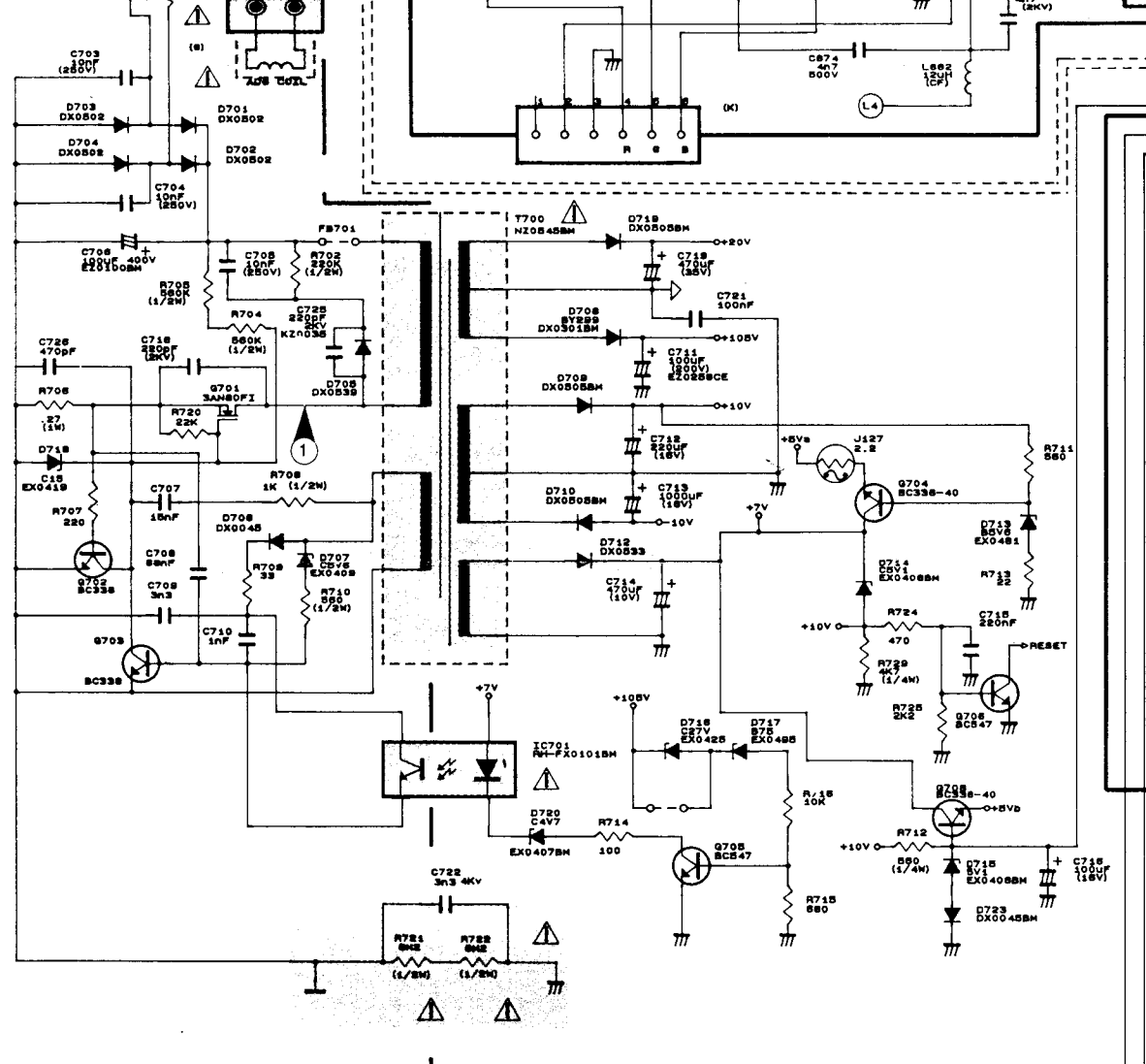

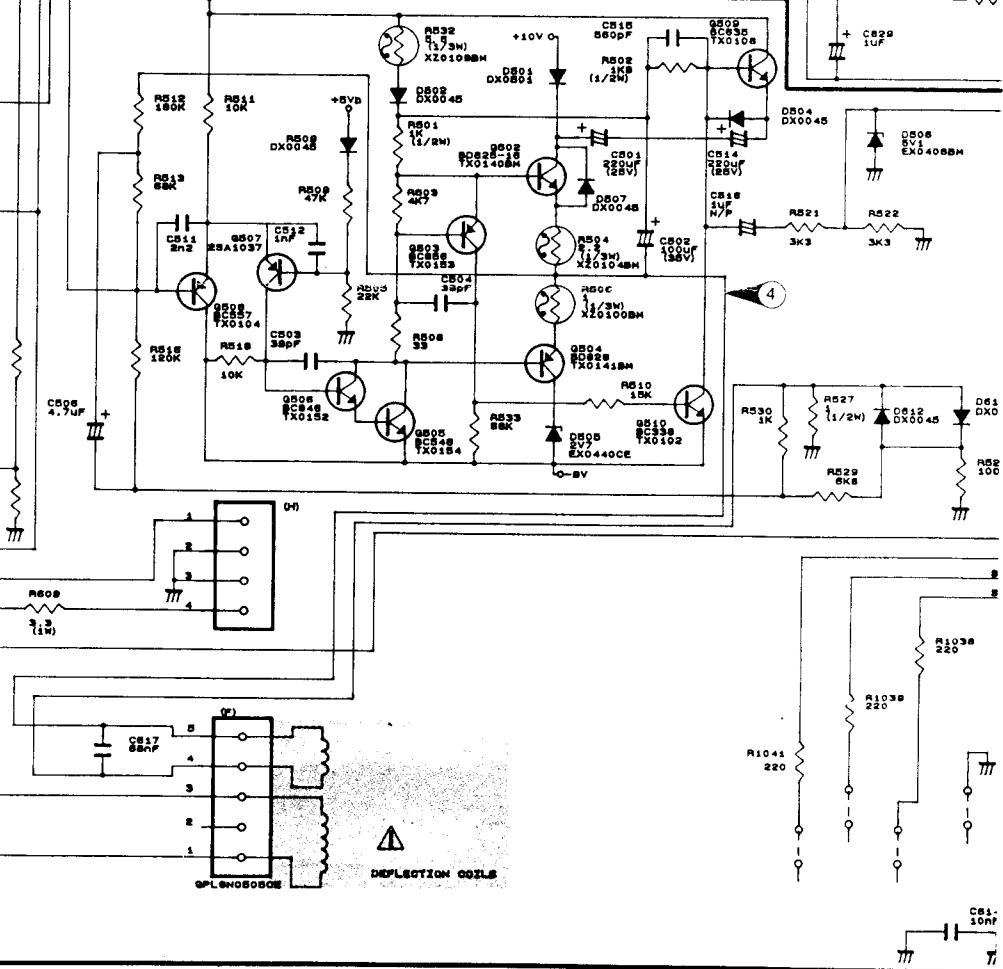
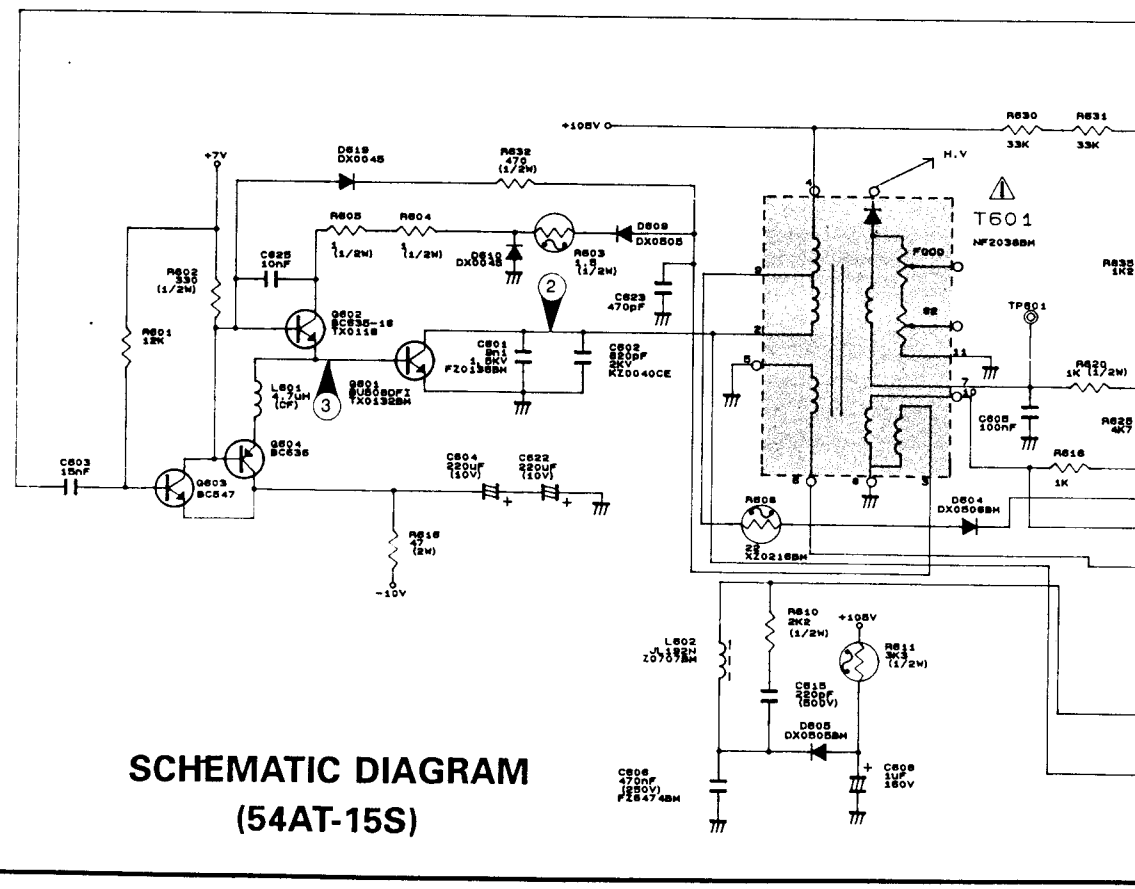
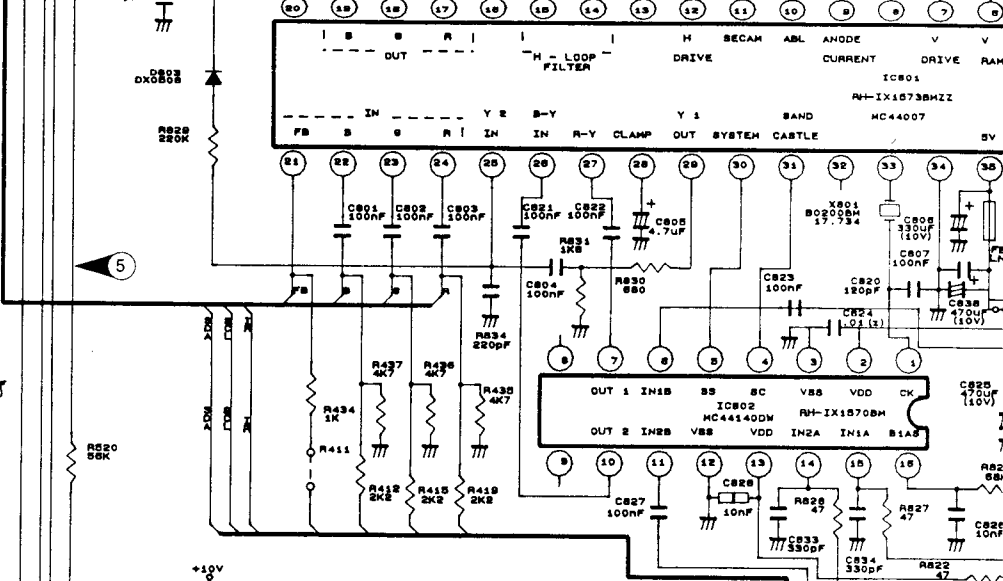
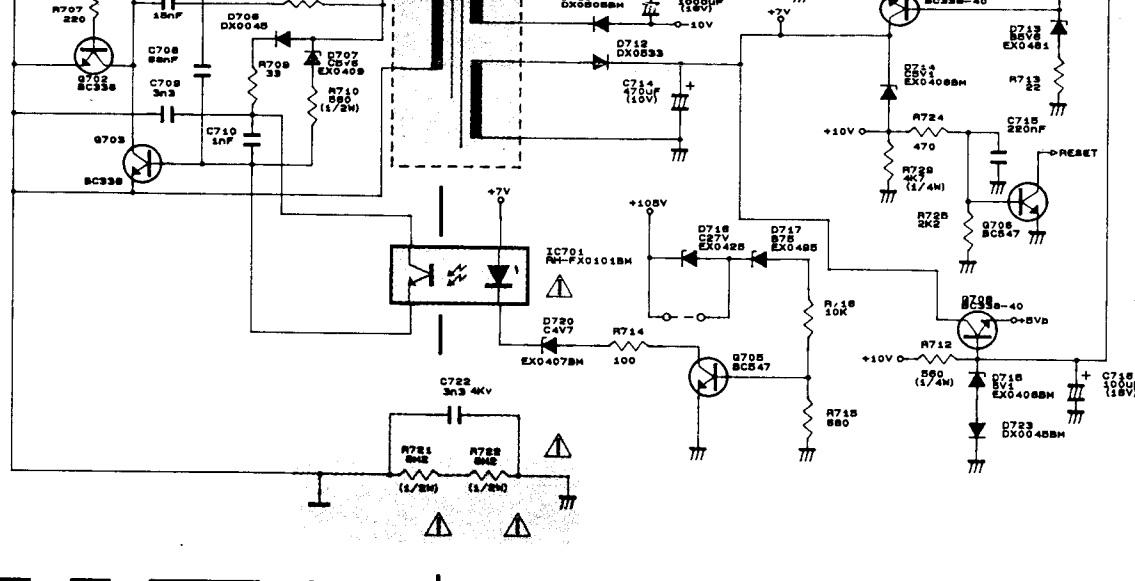

**SCHEMATIC DIAGRAM
(54AT-15S)**

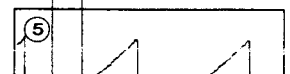
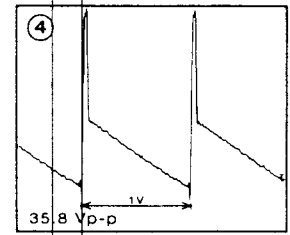
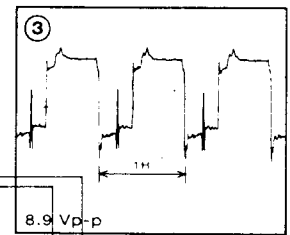
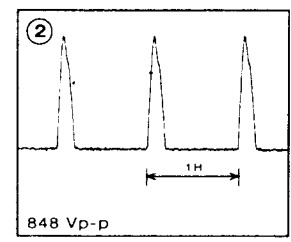
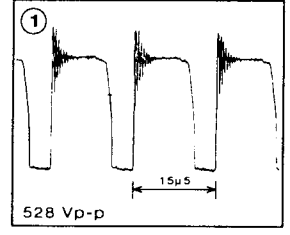
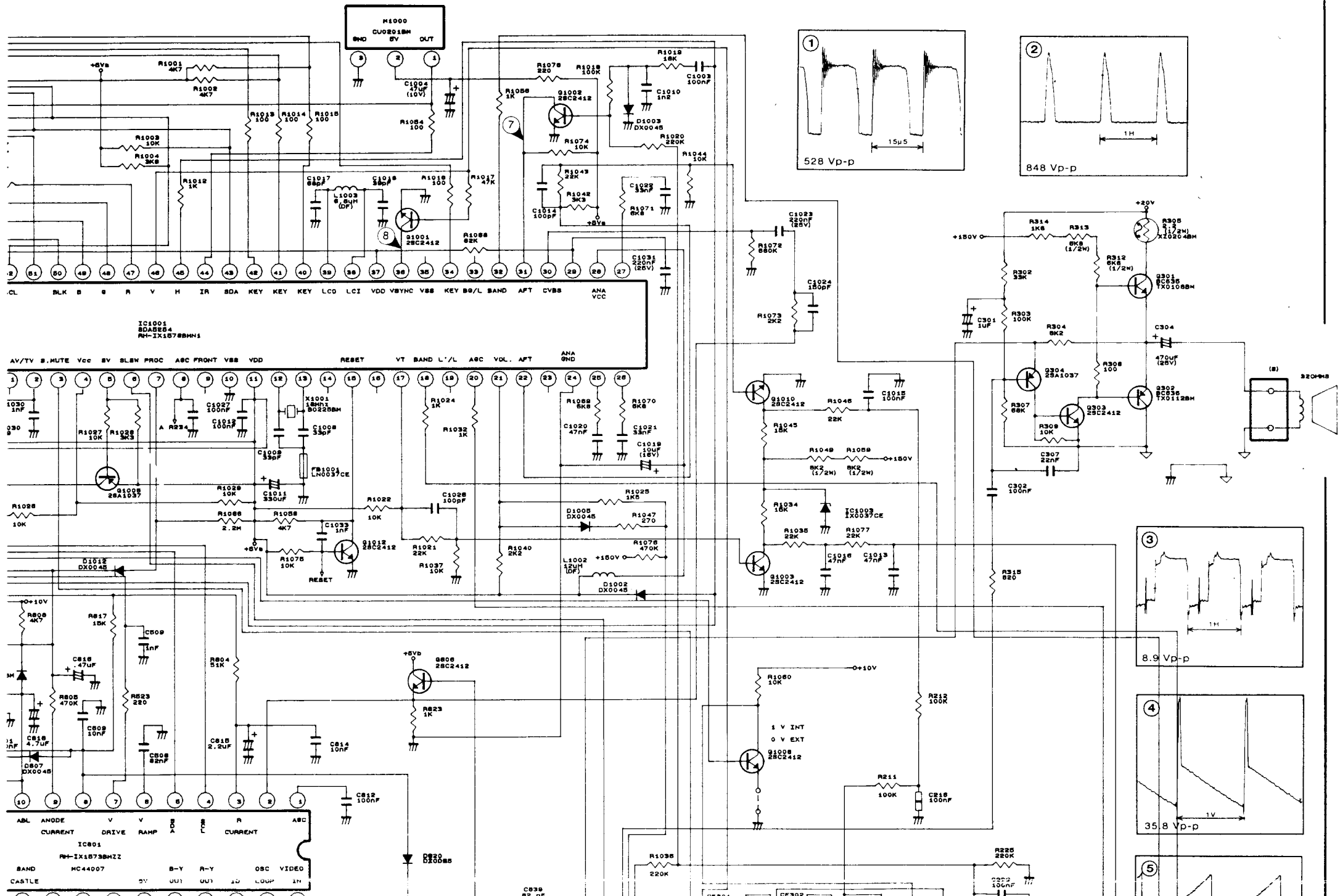

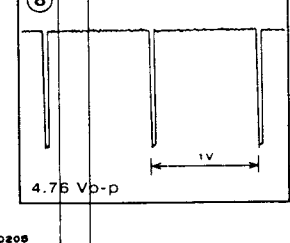
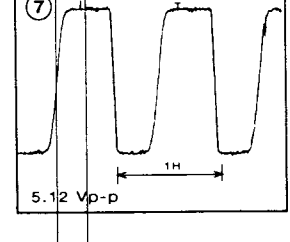
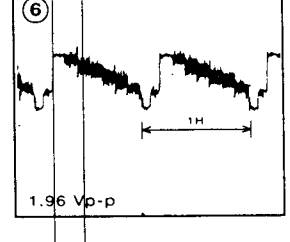
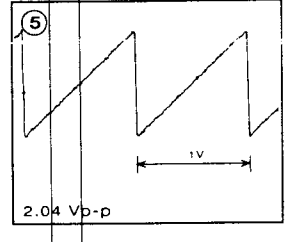
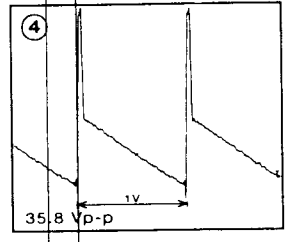
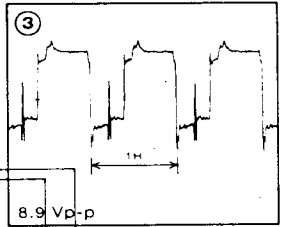
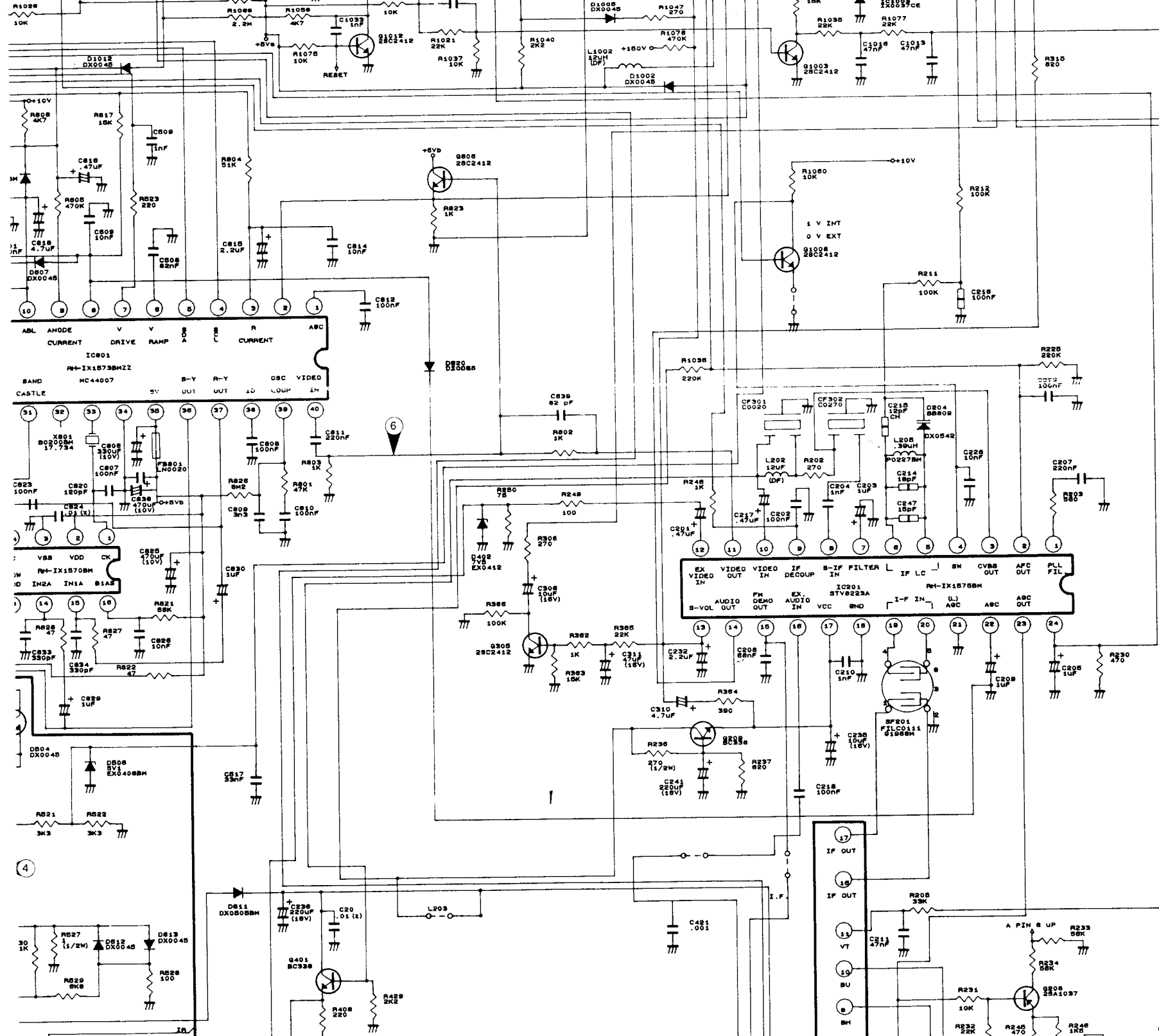

Q201 BC338 EX04138M

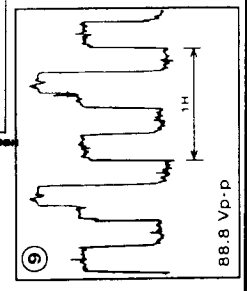
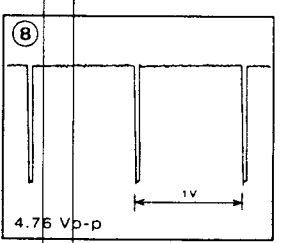
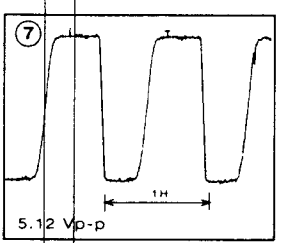
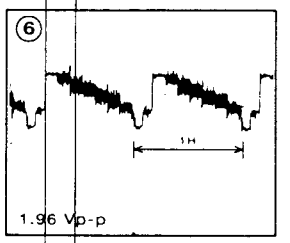
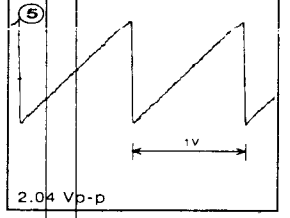
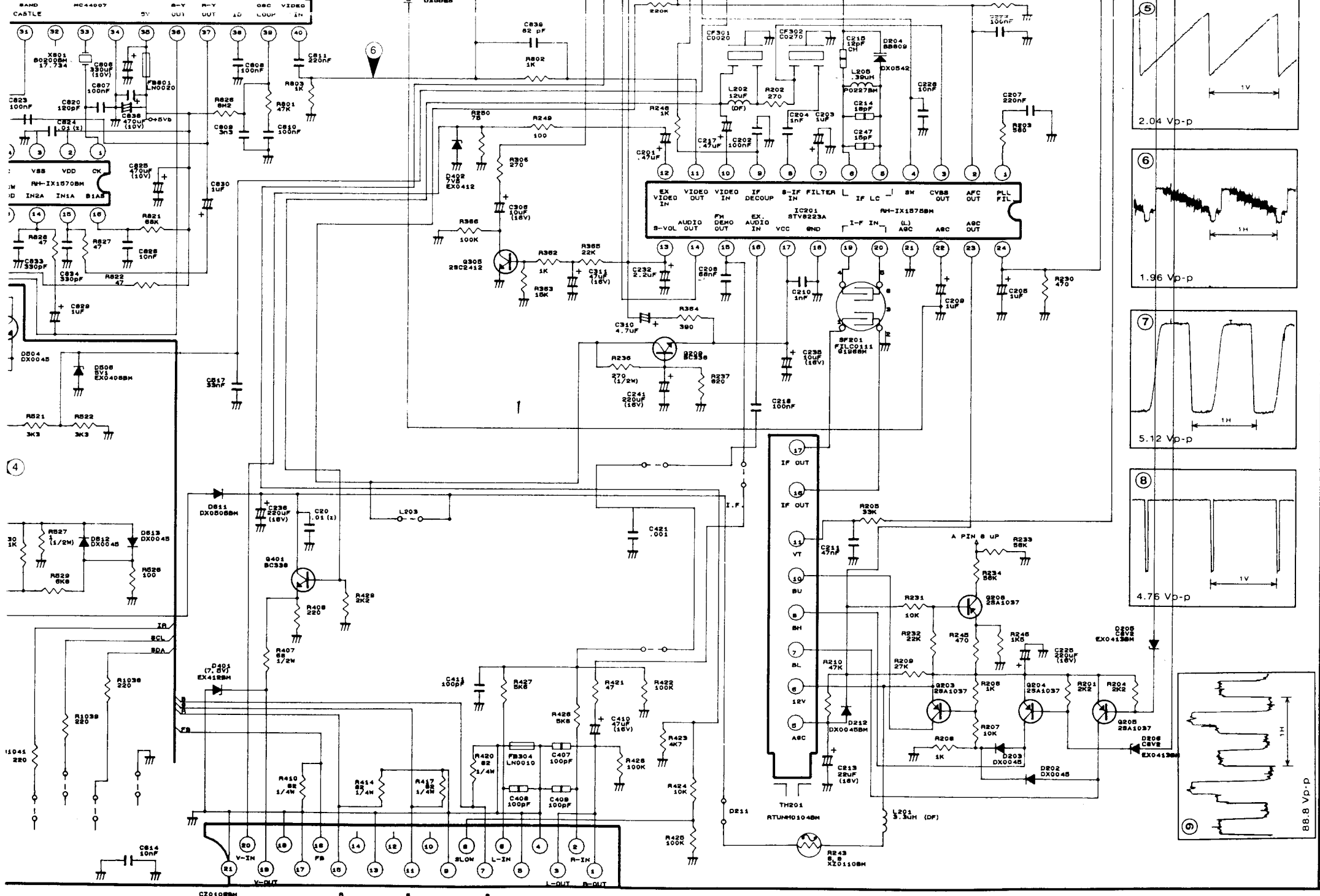

CAZ0109BH A B C