

OPERATION MANUAL

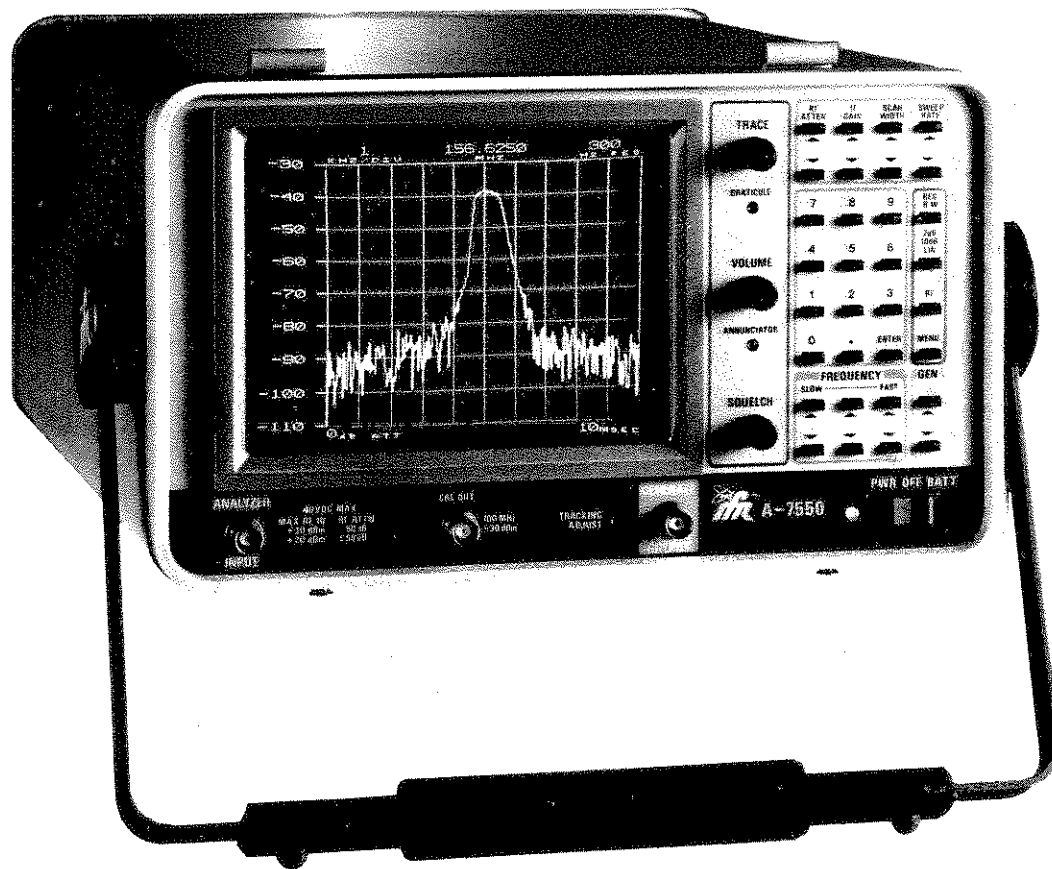

A-7550 SPECTRUM ANALYZER



10200 West York Street/Wichita Kansas 67215 U.S.A./ (316) 522-4981/TWX 910-741-6952

1002-5301-000

PUBLISHED BY
IFR SYSTEMS, INC.
Wichita, Kansas

Copyright © 1988 by IFR SYSTEMS, INC.

All rights reserved. Printed in the United States of America. No part of this publication may be reproduced, stored in a retrieval system, or transmitted in any form or by any means, electronic, mechanical, photocopying, recording or otherwise without the prior permission of the publisher.

WARNING:

HIGH VOLTAGE EQUIPMENT

THIS EQUIPMENT CONTAINS CERTAIN CIRCUITS AND/OR COMPONENTS OF EXTREMELY HIGH VOLTAGE POTENTIALS, CAPABLE OF CAUSING SERIOUS BODILY INJURY OR DEATH. WHEN PERFORMING ANY OF THE PROCEDURES CONTAINED IN THIS MANUAL, HEED ALL APPLICABLE SAFETY PRECAUTIONS.

RESCUE OF SHOCK VICTIMS

1. DO NOT ATTEMPT TO PULL OR GRAB THE VICTIM
2. IF POSSIBLE, TURN OFF THE ELECTRICAL POWER.
3. IF YOU CANNOT TURN OFF ELECTRICAL POWER, PUSH, PULL OR LIFT THE VICTIM TO SAFETY USING A WOODEN POLE, A ROPE OR SOME OTHER DRY INSULATING MATERIAL.

FIRST AID

1. AS SOON AS VICTIM IS FREE OF CONTACT WITH SOURCE OF ELECTRICAL SHOCK, MOVE VICTIM A SHORT DISTANCE AWAY FROM SHOCK HAZARD.
2. SEND FOR DOCTOR AND/OR AMBULANCE.
3. KEEP VICTIM WARM, QUIET AND FLAT ON HIS/HER BACK.
4. IF BREATHING HAS STOPPED , ADMINISTER ARTIFICIAL RESUSCITATION. STOP ALL SERIOUS BLEEDING.

CAUTION

INTEGRATED CIRCUITS AND SOLID STATE DEVICES SUCH AS MOS FET'S, ESPECIALLY CMOS TYPES, ARE SUSCEPTIBLE TO DAMAGE BY ELECTROSTATIC DISCHARGES RECEIVED FROM IMPROPER HANDLING, THE USE OF UNGROUNDED TOOLS, AND IMPROPER STORAGE AND PACKAGING. ANY MAINTENANCE TO THIS UNIT MUST BE PERFORMED WITH THE FOLLOWING PRECAUTIONS:

1. BEFORE USING IN A CIRCUIT, KEEP ALL LEADS SHORTED TOGETHER EITHER BY THE USE OF VENDOR-SUPPLIED SHORTING SPRINGS OR BY INSERTING LEADS INTO A CONDUCTIVE MATERIAL.
2. WHEN REMOVING DEVICES FROM THEIR CONTAINERS, GROUND THE HAND BEING USED WITH A CONDUCTIVE WRISTBAND.
3. TIPS OF SOLDERING IRONS AND/OR ANY TOOLS USED MUST BE GROUNDED.
4. DEVICES MUST NEVER BE INSERTED INTO NOR REMOVED FROM CIRCUITS WITH POWER ON.
5. PC BOARD, WHEN TAKEN OUT OF THE SET, MUST BE LAID ON A GROUNDED CONDUCTIVE MAT OR STORED IN A CONDUCTIVE STORAGE BAG.

NOTE

Remove any built-in power source, such as a battery, before laying PC Boards on conductive mat or storing in conductive bag.

6. PC BOARDS, IF BEING SHIPPED TO THE FACTORY FOR REPAIR, MUST BE PACKAGED IN A CONDUCTIVE BAG AND PLACED IN A WELL-CUSHIONED SHIPPING BOX.

LIST OF EFFECTIVE PAGES

The manual pages listed below which are affected by a current change or revision, are so identified by a revision number and an asterisk.

Date of issue for original and changed pages are:

Original	0	September, 1985
Revision	1	December, 1985
Revision	2	March, 1986
Revision	3	December, 1986
Revision	4	March, 1987
Revision	5	August, 1987
Revision	6	March, 1988

TOTAL NUMBER OF PAGES IN THIS MANUAL IS 138 CONSISTING OF FOLLOWING:

Pg. No.	Change No.	Pg. No.	Change No.
Title	0	6-1	3
*Copyright	6	*6-2 thru 6-2a	6
Warning	0	*6-2b Blank	6
Caution	0	6-3 thru 6-4	3
*A	6	6-5 thru 6-6	4
B Blank	0	6-7 thru 6-8	3
i	5	6-9	4
ii Blank	5	6-10 thru 6-12	3
*iii thru viii	6	7-1	3
*1-1 thru 1-3	6	7-2	4
*1-4 Blank	6	7-3 thru 7-9	3
*2-1	6	7-10 Blank	3
2-2	4	*A-1 thru A-4	6
2-3	5	*B-1 thru B-15	6
2-4 Blank	3	*B-16 Blank	6
3-1 Blank	3	C-1	4
3-2	3	C-2	3
*3-3 thru 3-17	6	C-3	4
*3-18 Blank	6	C-4 thru C-5	3
4-1 Blank	3	C-6 Blank	3
4-2 thru 4-16	5	D-1	4
*4-17	6	D-2 Blank	3
4-18 thru 4-20	5	E-1	4
5-1 thru 5-9	3	E-2	5
5-10 thru 5-11	4	*E-3	6
5-12 thru 5-13	3	E-4	4
5-14	4	*F-1	6
5-15 thru 5-17	3	F-2	5
5-18 Blank	3	G-1 thru G-2	5



PREFACE

SCOPE

This manual contains instructions for operating the A-7550 Spectrum Analyzer. It is strongly recommended that the operator be thoroughly familiar with Sections 1 through 3 of this manual before attempting to operate the A-7550.

This revision of the A-7550 Operation Manual includes extensive modifications, which include Software Version 2.40 and 3.40. Versions 2.40 and 3.40 add the auto feature to the Plotter Function and enhances Bandwidth Optimization.

ORGANIZATION

This Operation Manual is divided into the following major sections:

SECTION 1 - INTRODUCTION

Provides a brief introduction to the A-7550, including standard and optional features.

SECTION 2 - INSTALLATION

Provides a step-by-step procedure for preparing the A-7550 for operation.

SECTION 3 - DESCRIPTION OF CONTROLS, CONNECTORS & INDICATORS

Identifies and functionally describes all A-7550 controls, connectors and indicators.

SECTION 4 - MENU OPERATION

Provides a functional description of A-7550 menu operation and a detailed description of each menu.

SECTION 5 - GPIB OPERATION

Provides instructions for A-7550/GPIB Interface.

SECTION 6 - RS-232 OPERATION

Provides instructions for A-7550/RS-232 Interface.

SECTION 7 - QUASI-PEAK OPERATION

Provides instructions for Quasi-Peak operation.

The Appendices of this manual contain A-7550 specifications, and some procedures which are not required for all A-7550 users.



TABLE OF CONTENTS

Paragraph	Title	Page
	List of Effective Pages	A
	Preface	i
	Table of Contents	iii
	List of Illustrations	vii
	List of Tables	viii

SECTION 1 - INTRODUCTION

1-1	General	1-1
1-2	Standard Features	1-1
1-2-1	Display Method	1-1
1-2-2	Measurements with the A-7550 Spectrum Analyzer	1-1
1-2-3	Optimum Input Level	1-2
1-3	Optional Features	1-2
1-3-1	Battery - Option 01	1-2
1-3-2	Tracking Generator with 0-75 dB Attenuator - Option 02	1-2
1-3-3	+20 dB External Amplifier - Option 03	1-2
1-3-4	10.7 MHz FM/AM Receiver - Option 04	1-2
1-3-5	GPiB - Option 05; RS-232 Interface - Option 06	1-2
1-3-6	50 Ω /75 Ω Selectable Impedance - Option 07	1-3
1-3-7	Quasi-Peak Filter - Option 08	1-3
1-3-8	Maintenance Kit - Option 09	1-3
1-3-9	Camera Mount Adapter - Option 10	1-3
1-3-10	Carrying Case - Option 11	1-3

SECTION 2 -INSTALLATION

2-1	Initial Unit Check	2-1
2-2	Installation and Operation Precautions	2-1
2-3	Preparation for Use	2-2
2-3-1	External AC Power	2-2
2-3-2	External DC Power	2-2
2-3-3	Internal Battery Power	2-2
2-4	Clearing the Display	2-3

SECTION 3 - DESCRIPTION OF CONTROLS, CONNECTORS AND INDICATORS

3-1	Front Panel	3-2
3-2	Rear Panel	3-4
3-3	CRT Display	3-6
3-3-1	CRT Display Values	3-6
3-3-1-1	Scan Width Display	3-6
3-3-1-2	Center Frequency Display	3-7
3-3-1-3	Bandwidth Display	3-7
3-3-1-4	Menu Display	3-7
3-3-1-5	Sweep Rate Display	3-7
3-3-1-6	RF Attenuation Display	3-7
3-3-1-7	Graticules/dB Scale Labels	3-7
3-3-1-8	Graticule Unit Display	3-8
3-3-1-9	Tracking Generator Display	3-9
3-3-2	Special Display Messages and Indicators	3-9
3-3-2-1	UNCAL Message	3-9
3-3-2-2	UNLOCK Message	3-9
3-3-2-3	Auto Cal Indicator (Ac)	3-9
3-3-2-4	Manual Bandwidth Indicator (M \rightarrow)	3-9
3-3-2-5	Manual Sweep Rate Indicator (M \rightarrow)	3-9
3-3-2-6	Video Filter Indicator (vF 30K or vF 300)	3-9
3-4	Keyboard	3-10
3-4-1	RF ATTEN Keys	3-11
3-4-2	IF GAIN Keys	3-12
3-4-3	SCAN WIDTH Keys	3-12
3-4-4	SWEEP RATE Keys	3-14
3-4-5	RES B/W Key	3-14
3-4-6	2dB/10dB/LIN Keys	3-15
3-4-7	RF/ENTER Keys	3-15
3-4-8	MENU Key	3-16
3-4-9	FREQUENCY Keys	3-16
3-4-10	GEN Keys	3-17
3-4-11	NUMERIC Keys	3-17

SECTION 4 - MENU OPERATION

4-1	Menus	4-3
4-1-1	Menu Levels	4-3
4-1-2	Menu Operation Notes	4-4
4-2	MASTER Menu	4-4
4-3	DISPLAY (DISP) Menu	4-5
4-4	MODE Menu	4-6
4-5	RCVR Menu	4-8
4-6	FILTERS Menu	4-9
4-6-1	Video Filter Indicator	4-9
4-6-2	Filters Menu Selection	4-10
4-6-3	QUASI-PEAK Filter Menu	4-10

Paragraph	Title	Page
4-7	SETUP Menu	4-12
4-8	REMOTE Menu	4-13
4-8-1	GPIB Menu	4-14
4-8-2	RS-232 Menu	4-15
4-9	MANUAL Menu	4-16
4-10	TEST Menu	4-17
4-11	PLOT Menu	4-18
4-11-1	Plotter Installation	4-18
4-11-2	Plotter Operation	4-18
4-11-3	Plot Menu Functions	4-19
4-12	OPTION NOT INSTALLED Menu	4-20

SECTION 5 - GPIB OPERATION

5-1	Remote (GPIB) Operation	5-1
5-1-1	Preparation for Using GPIB	5-2
5-1-2	A-7550 and GPIB Message Interface	5-4
5-1-3	GPIB Transactions	5-5
5-1-4	Status and Service Request Transactions	5-6
5-2	Command and Data Structure	5-6
5-2-1	GPIB Commands to the A-7550	5-6
5-2-2	GPIB Command Data Format	5-7
5-2-3	Return Data Format	5-8
5-2-4	Reply Identifier	5-9
5-3	A-7550 Command Set	5-9

SECTION 6 - RS-232 OPERATION

6-1	Remote Control (RS-232) Operation	6-1
6-1-1	Preparation for Using RS-232	6-1
6-2	Command and Data Structure	6-2a
6-2-1	RS-232 Commands to the A-7550	6-2a
6-2-2	RS-232 Command Data Format	6-3
6-2-3	Return Data Format	6-4
6-2-4	Reply Identifier	6-4
6-3	A-7550 Command Set	6-4

SECTION 7 - QUASI-PEAK OPERATION

7-1	Quasi-Peak Purpose	7-1
7-2	Quasi-Peak Prerequisites	7-1
7-2-1	Units	7-1
7-2-2	Linear Mode	7-1
7-2-3	Scan Width Selection	7-2
7-2-4	Continuous Wave Signals	7-2
7-2-5	Time Constants	7-4
7-2-6	Line Impedance Stabilization Networks (LISN)	7-4
7-2-7	Antenna Factor	7-4
7-3	Quasi-Peak Measurement Procedure	7-5

Paragraph

Title

Page

APPENDICES

Appendix A	A-7550 Performance Specifications	A-1
Appendix B	Control Panel Test	B-1
Appendix C	Capturing A-7550 Analyzer Traces	C-1
Appendix D	A-7550 Signal Amplitude Values in Linear Mode	D-1
Appendix E	Optimization of Resolution Bandwidth and Sweep Rates	E-1
Appendix F	Repacking for Shipment	F-1
Appendix G	List of Abbreviations	G-1

LIST OF ILLUSTRATIONS

Figure No.	Title	Page
2-1	IFR Logo Display	2-3
3-1	A-7550 Front Panel	3-2
3-2	A-7550 Rear Panel	3-4
3-3	Interaction of CRT Display and Keyboard	3-6
4-1	Menu Access in Menu Operation	4-2
4-2	Master Menu	4-4
4-3	DISPLAY Menu	4-5
4-4	MODE Menu	4-6
4-5	RCVR Menu	4-8
4-6	FILTERS Menu	4-9
4-7	QUASI-PEAK Menu	4-10
4-8	SETUP Menus	4-12
4-9	GPIB Menu	4-14
4-10	RS-232 Menu	4-15
4-11	MANUAL Menu	4-16
4-12	TEST Menu	4-17
4-13	PLOT Menus	4-19
4-14	OPTION NOT INSTALLED Menu	4-20
5-1	GPIB Connector	5-2
5-2	IEEE-488 1978 Display Output	5-8
6-1	RS-232 Interface Connector	6-1
6-2	RS-232 Pinout for IBM-PC's (or compatible units)	6-2
7-1	Linear Scale	7-2
7-2	TC1 Amplitude Error (Frequency Range: 10 to 150 kHz)	7-3
7-3	TC2 Amplitude Error (Frequency Range: 150 kHz to 30 MHz)	7-3
7-4	TC3 Amplitude Error (Frequency Range: 30 MHz to 1 GHz)	7-3
7-5	Line Impedance Stabilization Network	7-4
7-6	Initial Background or Ambient Signals	7-5
7-7	Reference Display (With Ambient Signals Zeroed)	7-6
7-8	Reference Display with UUT Turned On	7-6
7-9	Signal of Interest at 100 MHz (TC3)	7-7
7-10	UUT Readout in Linear Mode	7-8
7-11	Frequency in Question Before Quasi-Peak	7-8
7-12	Frequency in Question with Quasi-Peak Activated	7-9
B-1	CAL OUT Signal Display	B-5
B-2	Live Trace to be Stored	B-7
B-3	Signal with 30 dB RF ATTEN	B-8
B-4	COMPARE Mode Display: STORED vs. LIVE TRACE	B-8
B-5	REF Mode Display (20 dB ATTEN Difference)	B-9
B-6	REF Mode Signal Display (0 dB ATTEN Difference)	B-9
B-7	Tracking Generator Display	B-14
F-1	Repacking for Shipment	F-2

LIST OF TABLES

Table No.	Title	Page
3-1	A-7550 Units Comparison	3-8
3-2	A-7550 Keyboard Entry Method	3-10
3-3	Interaction of RF ATTEN and IF GAIN	3-11
3-4	Maximum Scan Width Selection per Center Frequency Selection	3-13
3-5	Frequency Keys: Rate of Change	3-16
5-1	Pinout Table for GPIB Connector	5-2
5-2	IEEE-488 1978 BUS Messages	5-3
5-3	Status Bit Definition	5-6
5-4	A-7550 Instruction Set	5-10
6-1	RS-232 Connector Pinout	6-1
6-2	A-7550 Instruction Set	6-5
7-1	Optimum Sweep Rates for TC2 and TC3	7-2
7-2	Quasi-Peak Time Constants	7-4
D-1	A-7550 Signal Amplitude (A) Values For X = 20 Log (D ÷ 8)	D-1
E-1	Optimal Resolution Bandwidth Settings	E-1
E-2	Sweep Rate Optimization with No Video Filter	E-2
E-3	Sweep Rate Optimization with 300 Hz Video Filter	E-3
E-4	Sweep Rate Optimization with 30 kHz Video Filter	E-3

SECTION 1 - INTRODUCTION

1-1 GENERAL

The A-7550 Spectrum Analyzer is a microprocessor-controlled, super-heterodyne unit which offers ease of operation, while including the most needed features of a spectrum analyzer.

1-2 STANDARD FEATURES

The A-7550 Spectrum Analyzer covers a range from 100 kHz to 999.9999 MHz at levels of up to +30 dBm. Signal levels may be directly read on the CRT in either dBm, dB μ W, dBV, dBmV or dB μ V. Signals can be stored, recalled, plotted or used for comparison purposes. Standard A-7550 input impedance is 50 Ω . All operating parameters are set via keyboard operation.

1-2-1 DISPLAY METHOD

The A-7550 display is fully digitized. A VRS™ (Vertical Raster Scan) method is used to form the display. The display has 390 horizontal discrete points and 480 vertical discrete points. Full scan range is from 0 Hz to 1 GHz.

Users familiar with other spectrum analyzers may be used to seeing the zero hertz marker displayed anywhere on the display. On the A-7550, the zero hertz marker does not move to the right of the left edge of the display. The microprocessor does not allow a setting that would theoretically allow a "negative" frequency to the left of the zero hertz marker. The user should note this characteristic when becoming familiar with the A-7550.

1-2-2 MEASUREMENTS WITH THE A-7550 SPECTRUM ANALYZER

The A-7550 Spectrum Analyzer can be used for a wide variety of measurements within its frequency/amplitude domain. Some of the more important uses include: spectral purity, mixer products, modulation measurements, carrier suppression with Single SideBand Signals, harmonic levels, RF carrier levels, distortion and, with the Quasi-Peak filter, Electro-Magnetic Interference (EMI) measurements. When equipped with a Tracking Generator, the A-7550 Spectrum Analyzer can perform additional measurements, including: insertion loss, frequency response and return loss (VSWR).

1-2-3 OPTIMUM INPUT LEVEL

Maximum input level to the A-7550 is +30 dBm (1 Watt), if and only if 60 dB RF Attenuation is selected. Some degradation of amplitude accuracy occurs if high input levels are introduced to the A-7550 receiver.

CAUTION

SIGNALS EXCEEDING THE MAXIMUM INPUT LEVEL CAN CAUSE DAMAGE TO THE UNIT.

1-3 OPTIONAL FEATURES

The features described in the following subparagraphs are available with the A-7550 Spectrum Analyzer.

1-3-1 BATTERY - OPTION 01

The battery allows the A-7550 to operate for approximately 30 minutes without an external power source.

1-3-2 TRACKING GENERATOR WITH 0 TO 75 dB ATTENUATOR - OPTION 02

The Tracking Generator provides an RF signal at the same rate and the same frequency as the A-7550 analyzer. Maximum output level is 0 dBm. The output signal may be attenuated from 0 to -75 dBm in 1 dB steps.

1-3-3 +20 dB EXTERNAL AMPLIFIER - OPTION 03

This device may be connected to the EXT AMP Connector and the GENERATE OUTPUT Connector to increase Tracking Generator output level by 20 dB.

1-3-4 10.7 MHz FM/AM RECEIVER - OPTION 04

The demodulated audio from the receiver can be monitored through the speaker during zero scan operation, or on a time shared basis (see Paragraph 4-6).

1-3-5 GPIB - OPTION 05; RS-232 - OPTION 06

The GPIB enables external control of the A-7550 via a GPIB type bus. The RS-232 enables external control of the A-7550 via an RS-232 type bus. Both options provide communication facilities needed for fully automated testing. Only one option can be installed in the unit at a time.

1-3-6 50Ω/75Ω SELECTABLE IMPEDANCE - OPTION 07

The input impedance may be manually changed from 50Ω to 75Ω by connecting a 50-to-75Ω adapter to the ANALYZER INPUT Connector. The graticule labels for correct readout in 75Ω operation are changeable via menu operation. A second 50-to-75Ω adapter must be used for 75Ω Tracking Generator operation.

1-3-7 QUASI-PEAK FILTER - OPTION 08

With Quasi-Peak, the A-7550 becomes an EMI (Electro-Magnetic Interference) measurement device. Peak and Quasi-Peak modes are selectable through menu operation.

1-3-8 MAINTENANCE KIT - OPTION 09

The maintenance kit includes two ribbon cables, one PC Board Extender and one Digital Board Extender.

1-3-9 CAMERA MOUNT ADAPTER - OPTION 10

The Camera Mount Adapter fits over the CRT screen to provide a photographic environment for CRT displays. It is used with the Tektronix™ Model C-4 camera.

1-3-10 CARRYING CASE - OPTION 11

The Carrying Case protects the A-7550 during transport or storage.



SECTION 2 - INSTALLATION

2-1 INITIAL UNIT CHECK

Before attempting to take measurement readings with the A-7550 Spectrum Analyzer, read through to Section 4 of this manual and perform the operating procedures in Appendix B to check control panel operation.

2-2 INSTALLATION AND OPERATION PRECAUTIONS

To prevent possible damage to the A-7550, the following power input and general operating precautions should be observed at all times:

CAUTION

ANALYZER INPUT CONNECTOR:
MAXIMUM INPUT INTO THIS CONNECTOR MUST NOT EXCEED 4 VDC, +30 dBm FOR INPUT ATTENUATOR SETTING OF 60 dB, AND +20 dBm FOR ALL OTHER ATTENUATOR SETTINGS.

GENERATE OUTPUT CONNECTOR:
THIS CONNECTOR IS USED WHEN TRACKING GENERATOR OPTION (02) IS INSTALLED IN A-7550. DO NOT APPLY INPUT THROUGH THIS CONNECTOR.

INTENSITY:
DO NOT OPERATE CRT DISPLAY WITH EXCESSIVE INTENSITY.

PWR/OFF/BATT SWITCH:
TO PROVIDE MAXIMUM PROTECTION OF NON-VOLATILE MEMORY CONTENTS, OBSERVE THE FOLLOWING:

1. Allow a minimum of 5 seconds between selection of "PWR" and "OFF" positions. Do not rapidly cycle power on and off.
2. Ensure electrical power is not removed from A-7550 during data entry before ENTER Key is pressed, as the data being entered will be lost.

Do not apply any signals into the A-7550 other than those defined in the operating instructions. Other than the input power and operating precautions described above, any combination of front panel control positions will not adversely affect the A-7550.

2-3 PREPARATION FOR USE

Preparing the A-7550 for operation consists of the following:

1. Stand the A-7550 on its back set of feet. With the cover latch facing towards you, pull the pivot points of the stand out about $\frac{1}{2}$ " from both sides of the unit and rotate it towards you 90°. Release the pivots so they lock into place. The A-7550 can then be positioned on its stand for operation.
2. Unlatch the front cover and remove or pivot it out of the way. The power cords that can be used (AC and DC) are inside the cover. Slide the inside cover latch slightly to open it and remove the desired cord.
3. Apply electrical power to A-7550 per applicable subparagraph below.

2-3-1 EXTERNAL AC POWER

1. The A-7550 operates from 106 to 266 VAC, 50 to 400 Hz.
2. Connect furnished AC power cable between 106 to 266 VAC power source and AC Power Input connector on rear panel of A-7550.
3. Set PWR/OFF/BATT switch to "PWR".

2-3-2 EXTERNAL DC POWER

WARNING

DO NOT START A VEHICLE WITH THE A-7550 PLUGGED INTO THE ELECTRICAL SYSTEM OF THE VEHICLE.

1. The A-7550 operates from 12-30 VDC. The furnished DC Cable is intended for use with a cigarette lighter socket.
2. Connect furnished DC power cable between external 12-30 VDC power source and DC Power Input Connector on rear panel of A-7550.
3. Set PWR/OFF/BATT switch to "PWR".

2-3-3 INTERNAL BATTERY POWER (OPTIONAL)

1. The internal battery can furnish up to 30 minutes of remote operation where external AC or DC is not available.
2. Press PWR/OFF/BATT Switch to "BATT".
3. An internal timer circuit shuts off battery power after approximately 10 minutes of operation. The PWR/OFF/BATT Switch may be set to "BATT" again for further operation.

4. An internal low-voltage circuit discontinues battery operation if battery voltage drops below approximately 11.4 VDC.
5. The internal battery is rechargeable. Connect the test set to an external AC or DC power supply. Charging the battery requires at least 12 hours and at least 15 VDC, for a full charge.

2-4 CLEARING THE DISPLAY

NOTE

The A-7550 is operable immediately upon power-up. However, for optimum operation at specifications, allow a ten minute warm-up period.



Figure 2-1 IFR Logo Display

NOTE

The version indicated at the bottom of the Logo Display reflects the software version in the unit.

Whenever the A-7550 is first powered up, the IFR logo should appear on the CRT display as shown in Figure 2-1. After a short period of time following power-up, the logo is automatically cleared from the display. Pressing any button on the keyboard can also be used to clear the display. The analyzer is then ready for operation. Refer to Section 3 for Control Operating Procedures and Section 4 for Menu Operating Procedures.



SECTION 3 - DESCRIPTION OF CONTROLS, CONNECTORS AND INDICATORS

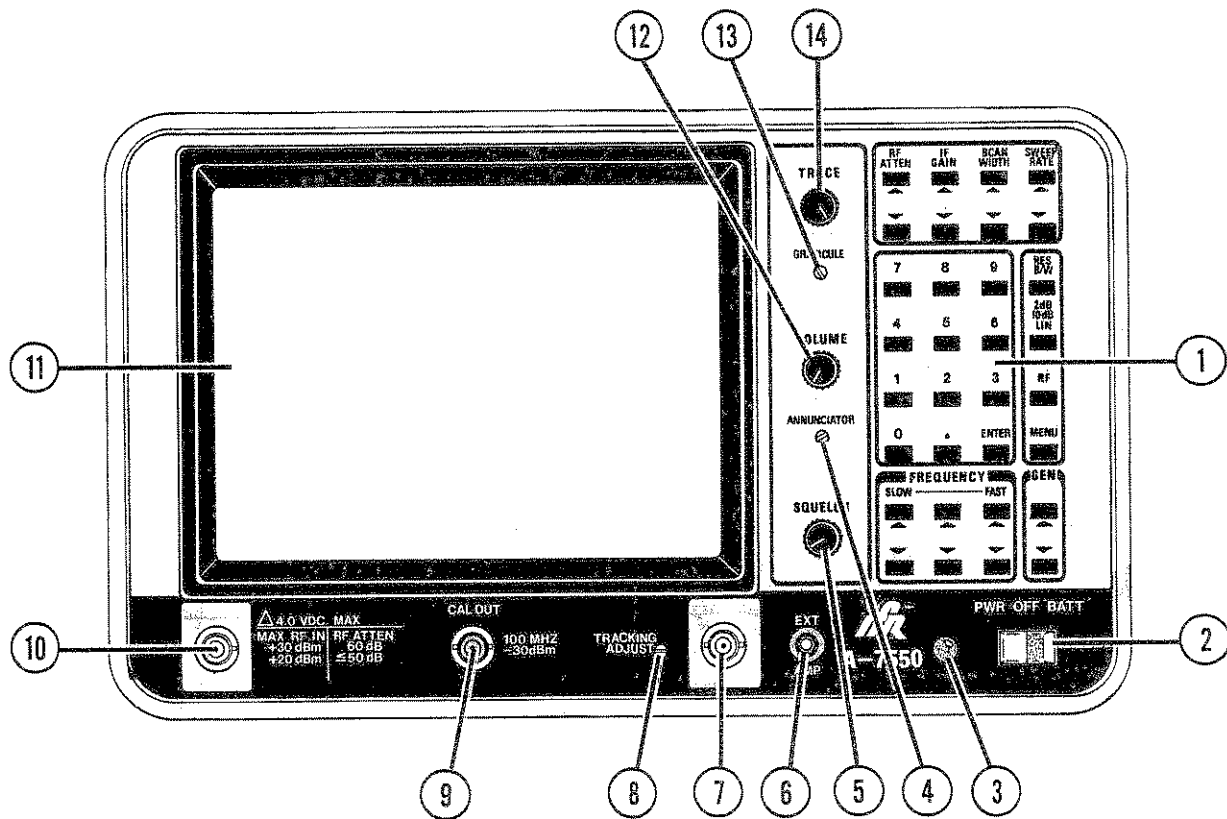

- | | |
|------------------------------|--------------------------------|
| 1. KEYBOARD | 8. TRACKING Adjust |
| 2. PWR/OFF/BATT Switch | 9. CAL OUT Connector |
| 3. POWER ON Indicator | 10. ANALYZER INPUT Connector |
| 4. ANNUNCIATOR Volume Adjust | 11. CRT Display |
| 5. SQUELCH Control | 12. VOLUME Control |
| 6. EXT AMP Connector | 13. GRATICULE Intensity Adjust |
| 7. GENERATE OUTPUT Connector | 14. TRACE Intensity Adjust |

Figure 3-1 A-7550 Front Panel

7. GENERATE OUTPUT Connector

Output connector used for Tracking Generator output if this option is installed. Impedance is normally 50Ω , but may be manually set to 75Ω if optional adapter is installed. To operate at 75Ω , the SETUP menu should be changed for proper amplitude readings on CRT.

8. TRACKING Adjust

Adjusts frequency of Tracking Generator to match the Analyzer, if this option is installed. Adjust for peak signal using 300 Hz Bandwidth and GENERATE OUTPUT (7) connected to ANALYZER INPUT (10).

9. CAL OUT Connector

Provides a 100 MHz signal at -30 dBm to check accuracy of A-7550. CAL OUT Connector must be connected to ANALYZER INPUT Connector with a coax cable for this check.

10. ANALYZER INPUT Connector

Input connector for signal of interest. Input impedance is normally 50Ω , but may be set to 75Ω . Impedance is manually set to 75Ω with optional adapter and by changing SETUP menu.

11. CRT Display

Spectrum Analyzer display for A-7550. Refer to paragraph 3-3 for further information.

12. VOLUME Control

Controls demod audio level out of A-7550 speaker. This control is operable only if 10.7 MHz Receiver Option is installed.

13. GRATICULE Intensity Adjust

Adjusts brilliance of displayed graticules. Adjust for desired contrast between displayed signals (trace) and graticules.

14. TRACE Intensity Adjust

Controls brilliance of displayed signal, field labels, and controls intensity of menu.

3-2 REAR PANEL

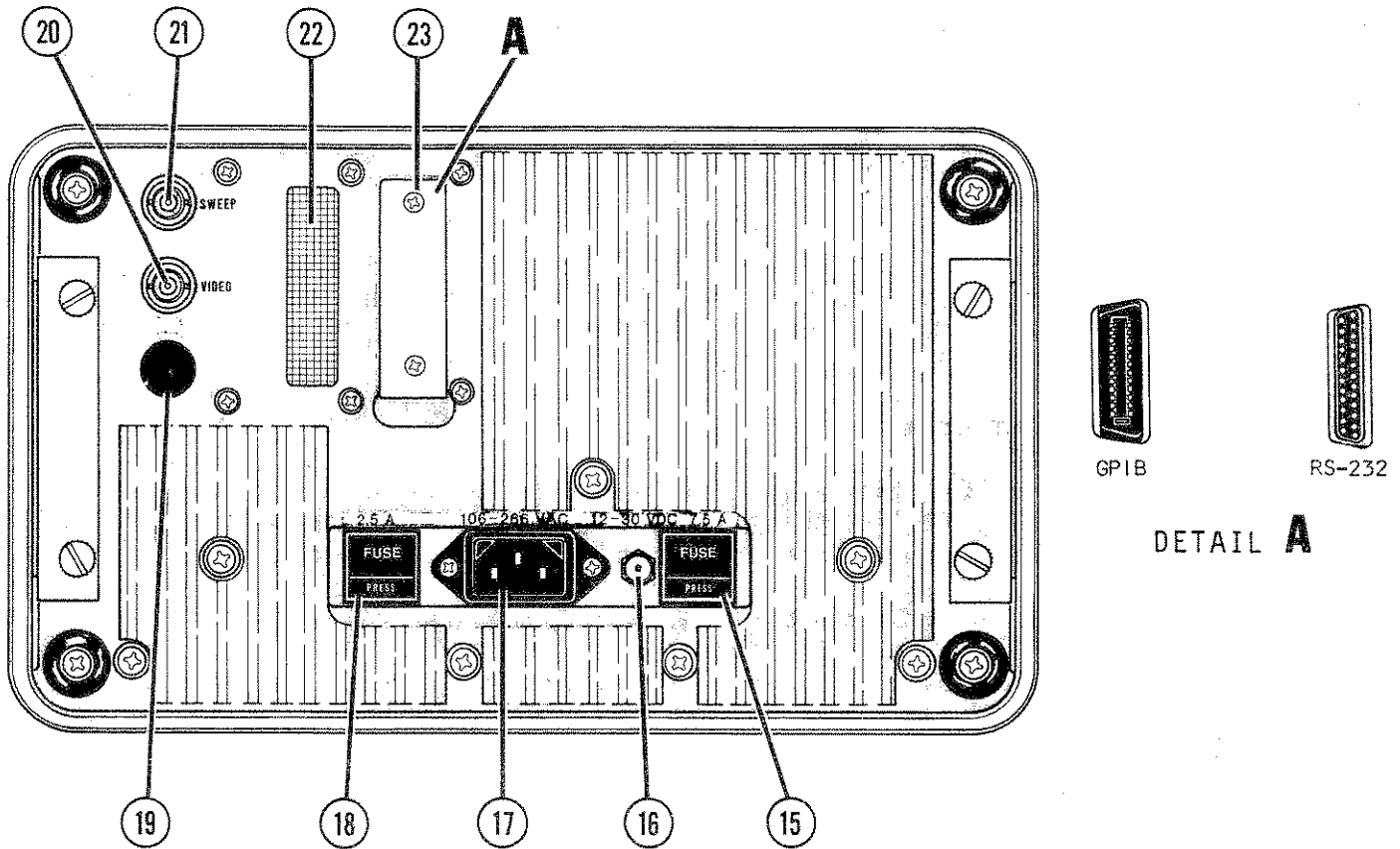

- | | |
|------------------------------|--|
| 15. DC Fuse | 20. ANALOG VIDEO OUT Connector |
| 16. DC Power Input Connector | 21. SWEEP OUT Connector |
| 17. AC Power Input Connector | 22. Fan Exhaust Port |
| 18. AC Line Fuse | 23. GPIO or RS-232 Connector
(option) |
| 19. Not used | |

Figure 3-2 A-7550 Rear Panel

Refer to Figure 3-2 to locate the following on the back panel of the A-7550.

- 15. DC Fuse (7½ Amp, 32 VDC)
- 16. DC Power Input Connector (12 to 30 VDC, nominal)
- 17. AC Power Input Connector
Input connector for 106 to 266 VAC supply at 50 to 400 Hz.
- 18. AC Line Fuse (2½ Amp, 250 V)
- 19. Not used.

20. ANALOG VIDEO Out Connector

Provides an analog video output signal before trace display is digitized. May be connected to external equipment.

CAUTION

THIS PORT IS HIGH IMPEDANCE (0 TO 800 mVDC OUTPUT, NOMINAL, INTO 1 M Ω). ANY DEVICE CONNECTED TO IT MUST HAVE A HIGH IMPEDANCE INPUT TO PREVENT DAMAGE TO THE UNIT.

21. SWEEP Out Connector

Provides an analog sweep output signal corresponding to the displayed digital sweep signal. May be connected to external equipment.

CAUTION

THIS PORT IS HIGH IMPEDANCE (0 TO 5 V RAMP OUTPUT, NOMINAL, INTO 1 M Ω). ANY DEVICE CONNECTED TO IT MUST HAVE A HIGH IMPEDANCE INPUT TO PREVENT DAMAGE TO THE UNIT.

22. Fan exhaust port.

23. GPIB or RS-232 Connector

Provides connection between A-7550 microprocessor and external controller. This connector interfaces between GPIB or RS-232 Connectors (Options 05 and 06) and the A-7550 microprocessor. While both options cannot be installed at the same time, the connection is interchangeable for use with either bus type.

3-3 CRT DISPLAY

The CRT Display graphics are automatically updated by the A-7550 microprocessor and controlled either through keyboard entries or, if installed, by remote unit entries (i.e., units connected via GPIB or RS-232). The CRT Display graphics include the trace functions, dB level and graticules, blocks for analyzer settings and menu displays.

3-3-1 CRT DISPLAY VALUES

Following are the functions displayed on the A-7550 CRT (see Figure 3-3) and the keyboard components which control their settings. The keyboard is described in Paragraph 3-4.

3-3-1-1 SCAN WIDTH DISPLAY

This displays the current Scan Width. It is changed when one of the Scan Width keys (up or down) is pressed. Changing the Center Frequency may also change the Scan Width display. Paragraph 3-4-3 describes Scan Width Key operation.

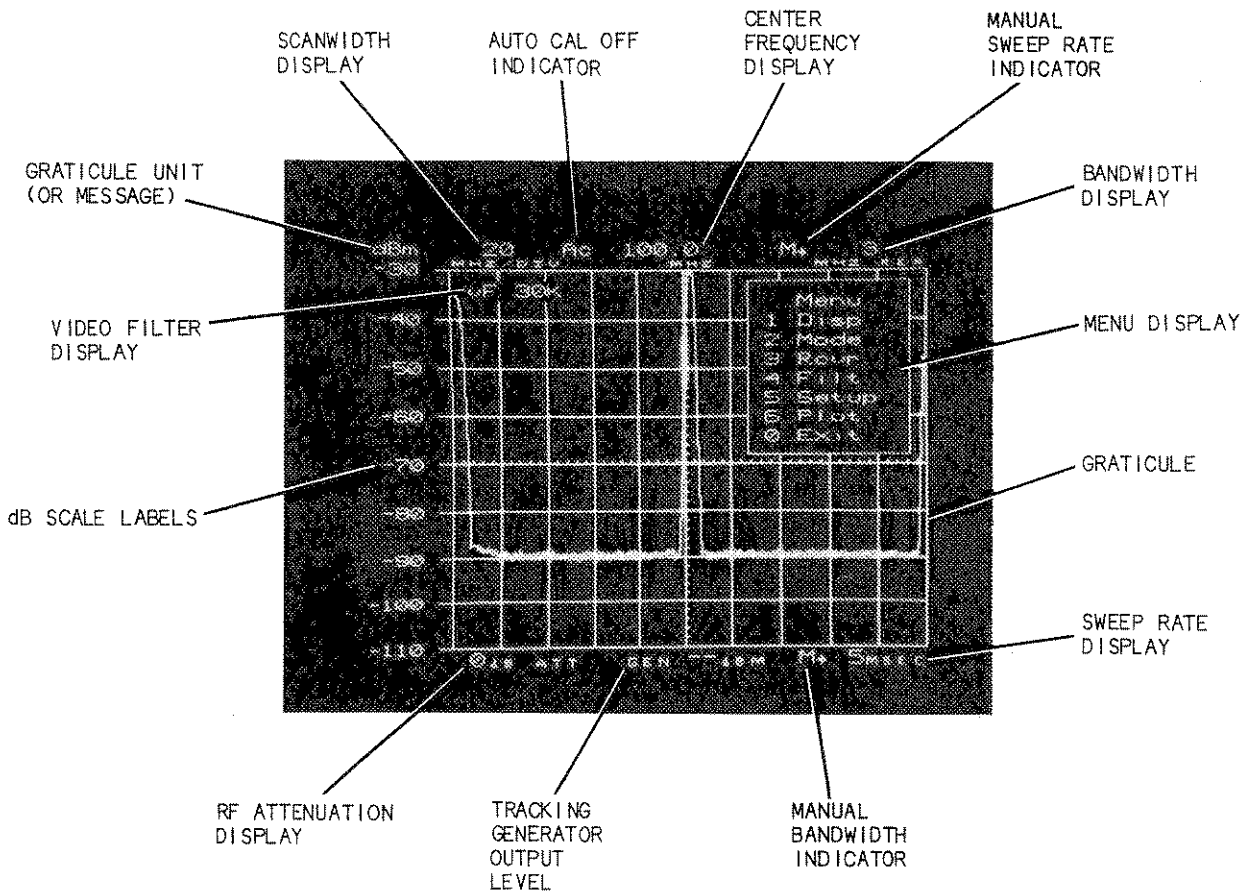

Figure 3-3 Interaction of CRT Display and Keyboard

3-3-1-2 CENTER FREQUENCY DISPLAY

This displays the current value of the Center Frequency. The number of significant digits is affected by the Scan Width selection. The Center Frequency value changes if the following keys are pressed: RF, ENTER (with or without selection of a Center Frequency), or if the FREQUENCY keys are used. See Paragraphs 3-4-7, 3-4-9 and 3-4-11 for descriptions of the RF, ENTER, FREQUENCY and NUMERIC Keys.

3-3-1-3 BANDWIDTH DISPLAY

This displays the current Resolution Bandwidth setting. It changes when the RES B/W key is pressed (see Paragraph 3-4-5). It may also change if the Center Frequency is changed or if one of the SCAN WIDTH keys is pressed and Bandwidth Optimization is active (see Appendix E).

NOTE

During Quasi-Peak Operation, the Quasi-Peak function controls the Bandwidth block. Quasi-Peak bandwidths are assigned automatically at each Quasi-Peak operational selection.

3-3-1-4 MENU DISPLAY

This display shows the active menu. The area within the rectangular box (including the box) is called the menu "window". This appears only during menu operation. Paragraph 4-1 describes menu operation.

3-3-1-5 SWEEP RATE DISPLAY

This displays the current Sweep Rate. It changes when one of the Sweep Rate keys is pressed (see Paragraph 3-4-4). It can also change if the Scan Width or RES B/W keys are pressed and Sweep Rate optimization is active (see Appendix E).

3-3-1-6 RF ATTENUATION DISPLAY

This displays the current level of RF ATTENUATION. It changes when one of the RF ATTEN keys is pressed (up or down), within the 0 to 60 dB range of the A-7550. Changing the RF Attenuation can change the graticule and signal displays. Paragraph 3-4-1 describes RF Attenuation keyboard operation.

3-3-1-7 GRATICULES/dB SCALE LABELS

This shows the signal level and provides a numeric readout for the signal under observation. There are three settings for these labels: 10 dB/Division, 2 dB/Division and a LINEAR Scale. The 10 dB/Division and 2 dB Division scales provide a direct readout of the signal. The top graticule of the Linear scale shows the signal level with RF ATTEN and IF GAIN. Computing the Signal Amplitude on the Linear Scale is

discussed in Appendix D. Graticule scales are changed with the 2dB/10dB/LIN key, RF ATTEN keys, IF GAIN keys and the SETUP Menu. Paragraphs 3-4-1, 3-4-5 and 3-4-6 describe the various keyboard operations and Paragraph 4-7 describes the SETUP Menu.

NOTE

The peak signal indicated by the graticule label is the ACTUAL Analyzer Input RF level.

3-3-1-8 GRATICULE UNIT DISPLAY

This display shows the current calibration unit for the graticule scale labels. The unit can be changed in the SETUP Menu to dBm, dBμW, dBV, dBmV or dBμV (see Paragraph 4-7). Changing the unit also changes the graticule scales as shown in Table 3-1. Table 3-1 shows the top graticule labels as different units are selected, in order of menu appearance. The RF ATTEN and IF GAIN are kept constant. The difference between 75Ω readings and 50Ω readings are as they appear only if the impedance setting is changed.

UNIT	TOP GRATICULE (0 dB RF ATTEN, 0 dB IF GAIN)	TOP GRATICULE (30 dB RF ATTEN, 0 dB IF GAIN)
	<u>50Ω OPERATION</u>	
dBm	-30	0
dBmV	+17	+47
dBμV	+77	+107
dBV	-43	-13
dBμW	0	+30
	<u>75Ω OPERATION</u>	
dBm	-24	+6
dBmV	+25	+55
dBμV	+85	+115
dBV	-35	-36
dBμW	+6	+36

Table 3-1 A-7550 Units Comparison

NOTE

The peak signal indicated by the graticule label is the ACTUAL Analyzer Input RF level.

The unit block may also display an error condition, if one is detected. Paragraph 3-3-2 describes these conditions, and several other messages displayed on the A-7550 Spectrum Analyzer.

3-3-1-9 TRACKING GENERATOR DISPLAY

This displays the current level of Tracking Generator output. If the Tracking Generator is not installed, this display is inhibited from the CRT. When the Tracking Generator is active, the level changes whenever the output level changes using the GEN keys (see Paragraph 3-4-10). When the Tracking Generator is installed, but the Generator option is turned off (GEN = 0 in SETUP Menu), the display that appears is "GEN -- unit". The unit is always the same as the unit displayed above the graticule labels.

3-3-2 SPECIAL DISPLAY MESSAGES AND INDICATORS

3-3-2-1 UNCAL MESSAGE

This message is displayed where the Graticule Unit normally appears. It indicates the A-7550 is not at an optimal setting (see Appendix E).

3-3-2-2 UNLOK MESSAGE

This message is displayed where the Graticule Unit normally appears. It indicates an improperly functioning frequency synthesizer, which requires calibration or some other maintenance.

3-3-2-3 AUTO CAL INDICATOR (Ac)

This indicator is displayed if the Auto Cal feature is turned OFF. It is set in the MANUAL Menu (see Paragraph 4-9) and appears between the Scan Width and Center Frequency displays on the top of the screen.

3-3-2-4 MANUAL BANDWIDTH INDICATOR (M→)

This indicator (M→) is displayed in the upper right-hand corner of the screen. The arrow points to the Bandwidth display. It indicates Bandwidth Optimization is inactive (see Appendix E). This message appears only if "Bw" in the MANUAL Menu is set to "M" (see Paragraph 4-9).

3-3-2-5 MANUAL SWEEP RATE INDICATOR (M→)

This indicator (M→) appears in the lower right-hand corner of the screen. The arrow points to the Sweep Rate display. It indicates Sweep Rate Optimization is inactive (see Appendix E). This message appears only if "Swp" in the MANUAL Menu is set to "M" (see Paragraph 4-9).

3-3-2-6 VIDEO FILTER INDICATOR (vF 30k or vF 300)

The Video Filter Indicator is displayed only when one of the video filters (30 kHz or 300 Hz) is enabled. It appears in the upper-left quadrant of the CRT display. The indicator is set in the FILTERS Menu (see Paragraph 4-6).

3-4 KEYBOARD

Refer to Figure 3-3 to locate CRT displays and to Table 3-2 as a reference for entering key values.

Normally, when pressing any key on the KEYBOARD, a tone is heard and an applicable change is made on the CRT Display. However, if an entry is attempted that is out of range for that key, the microprocessor disables the tone and inhibits the entry. The operator must then enter a valid setting.

KEY	USE	ENTRY METHOD
RF ATTEN	RF Input atten from 0 to 60 dB In 10 dB steps	RF ATTEN up or RF ATTEN down
IF GAIN	Internal IF gain from 0 to 65 dB In 1 dB steps	IF GAIN up or IF GAIN down
SCAN WIDTH	Analyzer Display dispersion from 1 kHz/DIV to 100 MHz/DIV; 0 for fixed-tuned receiver	SCAN WIDTH up or SCAN WIDTH down
SWEEP RATE	Analyzer Display sweep rate from 5 mSec/DIV to 2 SEC/DIV	SWEEP RATE up or SWEEP RATE down
RES BW	Analyzer Bandwidth - 300 Hz, 3 kHz, 30 kHz, 300 kHz or 3 MHz	Press RES BW
2 dB/10 dB/LIN	Log - 10 dB or 2 dB per division on vertical scale Lin - selects Linear display mode	Press 2 dB/10 dB/LIN
RF	Direct center frequency change from 000,0050 to 999,9999 MHz	RF 999,9999 ENTER*
MENU	Calls up menus	Press MENU
FREQUENCY	Center frequency slewing	Press any of 6 FREQUENCY keys
GEN	RF output atten from 0 to -75 dBm In 1 dB steps	GEN up or GEN down
NUMBER Keys	Center frequency entry and menu ops	Redefined by RF and MENU
ENTER	Direct center frequency entry	RF 999,9999 ENTER*

*Values entered for RF entries can contain one to seven digits. The maximum length on either side of the decimal point is shown here. The decimal is optional for integer values (0-999). Entering an invalid value suppresses the beep tone.

Table 3-2 A-7550 KEYBOARD Entry Method

3-4-1 RF ATTEN KEYS

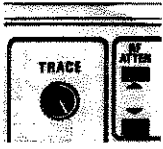

FUNCTION: Set the attenuation level of RF signal input.
RANGE: 0 to 60 dB, in 10 dB steps.
USE: RF ATTEN UP (↑) causes attenuation to increase. RF ATTEN DOWN (↓) causes attenuation to decrease. Using RF ATTEN with IF GAIN sets the top graticule of the CRT display as shown in Table 3-3. Generally, the RF ATTEN keys are used when the input signal level is greater than -30 dBm.

RF ATTEN	IF GAIN	Top Graticule Reading (dBm)
0	0	-30
10-60	0	-20 to +30
0	1-65	-31 to -95
10-60	1-65	+29 to -85

Table 3-3 Interaction of RF ATTEN and IF GAIN

NOTE

The graticule readings are automatically changed if the Reference Scale Unit is changed (see Table 3-1).

NOTE

If a key is pressed and no beep is heard and (or) the display blocks do no change, then you have reached the end of the range of values. Check the range of values for this function before selecting another entry.

3-4-2 IF GAIN KEYS

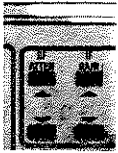

FUNCTION: Sets the internal IF gain level.
RANGE: 0 to 65 dB in 1 dB steps.
USE: IF GAIN UP (↑) causes gain to increase. IF GAIN DOWN (↓) causes gain to decrease. When used with RF ATTEN, the top graticule of the CRT display is set as shown in Table 3-3. (The IF GAIN value is not displayed.) The signal level is read directly from the CRT display, regardless of the IF GAIN and RF ATTEN settings.

NOTE

If a key is pressed and no beep is heard and (or) the display blocks do not change, then you have reached the end of the range of values. Check the range of values for this function before selecting another entry.

3-4-3 SCAN WIDTH KEYS

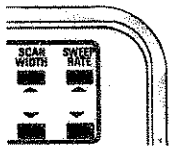

FUNCTION: Sets analyzer display dispersion.
RANGE: 0, 1, 2, 5, 10, 20, 50, 100, 200, 500 kHz/Div;
1, 2, 5, 10, 20, 50, 100 MHz/Div.
USE: SCAN WIDTH UP (↑) causes the dispersion to increase. SCAN WIDTH DOWN (↓) causes dispersion to decrease. Zero is selected for the fixed-tune receiver operation. Table E-1 shows the automatic settings of the A-7550 for selected Scan Widths.

The Scan Width settings also affect the FREQUENCY keys (see Table 3-5). For any center frequency selected, the microprocessor inhibits scan width settings which would produce a negative frequency at the left side of the CRT (see Table 3-4).

For example, if the scan width is set at 100 MHz, and the center frequency is set at 100.0000 MHz, SCAN WIDTH will be reset to 20 MHz.

CENTER FREQUENCY RANGE (MHz)	MAXIMUM SCAN WIDTH SELECTION
.0050 to .0099	1 kHz/Div
.0100 to .0249	2 kHz/Div
.0250 to .0499	5 kHz/Div
.0500 to .0999	10 kHz/Div
.1000 to .2499	20 kHz/Div
.2500 to .4999	50 kHz/Div
.5000 to .9999	100 kHz/Div
1.000 to 2.499	200 kHz/Div
2.500 to 4.999	500 kHz/Div
5.000 to 9.999	1 MHz/Div
10.00 to 24.99	2 MHz/Div
25.00 to 49.99	5 MHz/Div
50.00 to 99.99	10 MHz/Div
100.0 to 249.9	20 MHz/Div
250.0 to 499.9	50 MHz/Div
500.0 and up	100 MHz/Div

Table 3-4 Maximum Scan Width Selection per Center Frequency Selection

NOTE

Signals greater than 1 GHz should be disregarded.

NOTE

If a key is pressed and no beep is heard and (or) the display blocks do not change, then you have reached the end of the range of values. Check the range of values for this function before selecting another entry.

3-4-4 SWEEP RATE KEYS

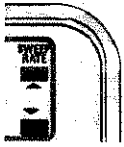

FUNCTION: Set Sweep Rate of analyzer display.
RANGE: 5, 10, 20, 50, 100, 200, 500 mSec/Div;
1, 2 Sec/Div.
USE: SWEEP RATE UP (↑) causes Sweep Rate to increase (i.e., Sweep Time decreases). SWEEP RATE DOWN (↓) causes Sweep Rate to decrease (i.e., Sweep Time increases). Sweep Rates can be automatically selected to correspond with the SCAN WIDTH and RES B/W keys. They can also be set automatically to Video Filter selections, as shown in Appendix E. Manual (independent) selection of the Sweep Rate is possible through Menu operation (see Paragraph 4-9). If no optimum Sweep Rate is available for the selected Scan Width or Resolution Bandwidth, "UNCAL" appears on CRT display (see Paragraph 3-3-2-1 and Figure 3-3).

NOTE

If a key is pressed and no beep is heard and (or) the display blocks do not change, then you have reached the end of the range of values. Check the range of values for this function before selecting another entry.

3-4-5 RES B/W KEY



FUNCTION: Manually sets Bandwidth of analyzer trace. (Bandwidth can be automatically set by the microprocessor, but the RES B/W key overrides the automatic selection. Automatic selection of bandwidth is shown in Table E-1.)
RANGE: 300 Hz, 3 kHz, 30 kHz, 300 kHz or 3 MHz.
USE: Resolution Bandwidth can be automatically or manually selected for each Bandwidth (see Paragraph 4-9). If no optimum Sweep Rate exists for Scan Width and Resolution Bandwidth, "UNCAL" appears on the CRT display (see Paragraph 3-3-2-1 and Figure 3-3).

3-4-6 2dB/10dB/LIN KEY



- FUNCTION:** Sets the vertical scale of analyzer graticule display.
- RANGE:** 2 dB increments, 10 dB increments or, using the LIN scale, 18 dB for the top 87.5 percent of the screen (see Appendix D).
- USE:** Top graticule axis is set by selecting RF ATTEN and IF GAIN settings per Table 3-3. 10 dB/2 dB sets each horizontal graticule in 10 dB or 2 dB increments. Intermediate horizontal graticules are not labeled in LINEAR mode.

3-4-7 RF/ENTER KEYS



- FUNCTION:** Selects and Enters Center Frequency.
- USE:** Entry of Center Frequency. Two selection processes can be used: manual and automatic. To manually select a Center Frequency, press the key sequence:

"RF" nnn.nnnn "ENTER"

Where RF is the RF key, nnn.nnnn is a value between 0.0050 and 999.999 MHz. ENTER must be pressed to update the Center Frequency in the microprocessor.

To automatically set the Center Frequency (to 500.0 MHz) and the Scan Width (to 100 MHz/Div), press the following keys:

"RF" "ENTER"

NOTE

Pressing RF cancels any menu display.

NOTE

If a key is pressed and no beep is heard and (or) the display blocks do not change, then the entry is invalid.

3-4-8 MENU KEY

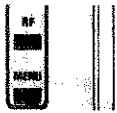

FUNCTION: Turns menu display on or off (see NOTE, below).

USE: Select functions and set values as required from various menus for A-7550 operation. Also, pressing MENU twice in succession from within any other menu returns menu control to the Master Menu (see Paragraph 4-1).

NOTE

Menu display can also be cleared by pressing RF once or pressing "0" one, two or three times, depending on the current menu level (see Paragraph 4-1).

NOTE

If a key is pressed and no beep is heard and (or) the display blocks do not change, then the entry is invalid.

3-4-9 FREQUENCY KEYS

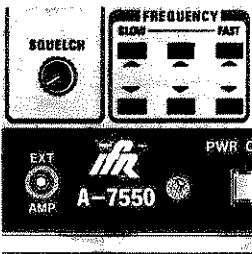

FUNCTION: Shift the Center Frequency display on CRT.

USE: The upper keys increase the Center Frequency. The lower keys decrease the Center Frequency. For all keys, the rate of center frequency change increases as the key selection progresses from left to right. The slow rate is dependent on the Scan Width (see Table 3-5).

For example, if 1 kHz/Div is selected as the Scan Width, frequency change rates from left-most key to right-most key would be 100 Hz, 1 kHz and 5 kHz, respectively.

FREQUENCY KEY	RATE OF CHANGE
left-most	1/10 DIV (SCAN WIDTH ÷ 10)
center	1 DIV (SCAN WIDTH ÷ 1)
right-most	5 DIV (SCAN WIDTH X 5)

Table 3-5 Frequency Keys: Rate of Change

3-4-10 GEN KEYS



FUNCTION: Sets the output attenuation level if the Tracking Generator option is installed and activated (see Paragraph 4-7).

RANGE: 0 to -75 dB in 1 dB steps.

USE: GEN UP (↑) key causes output level to increase. GEN DOWN (↓) key causes output level to decrease. Table 3-1 shows maximum output for various configurations.

3-4-11 NUMERIC KEYS

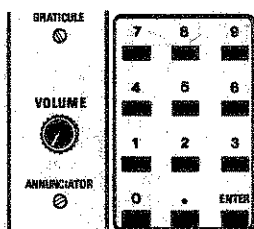

FUNCTION: Entering direct center frequency values and making menu selections. These functions are defined by the RF and MENU keys.

USE: With the RF key, select a Center Frequency between 0.0050 and 999.999 MHz (see RF/ENTER key description in Paragraph 3-4-7). With the MENU key, select menu parameters usually between 0 and 6 (see Paragraph 4-1).

NOTE

The microprocessor inhibits the number of significant digits entered after the decimal point, depending on the Scan Width selected.

NOTE

If a key is pressed and no beep is heard and (or) the display blocks do not change, then the entry is invalid. Check the value of the function before selecting another value.



SECTION 4 - MENU OPERATION

MASTER MENU
(1ST LEVEL MENU)

2ND LEVEL MENUS

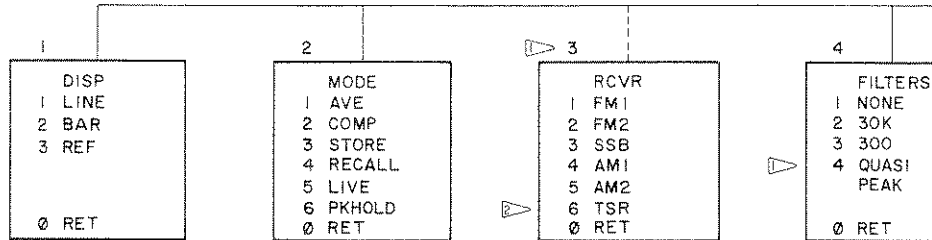

3RD LEVEL MENUS

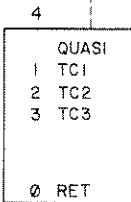
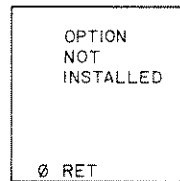

NOTES :

- 1 IF OPTION NOT INCLUDED, THE "OPTION NOT INSTALLED" SCREEN APPEARS
- 2 ONLY CURRENT SELECTION APPEARS IN MENU WINDOW
- 3 IF GEN OPTION NOT INSTALLED, THIS DISPLAY LINE IS INHIBITED
- 4 ONLY RS-232 OR GPIB MENU CAN BE DISPLAYED, DEPENDING ON OPTION INSTALLED. IF NEITHER OPTION IS INSTALLED, THE "OPTION NOT INSTALLED" SCREEN APPEARS
- 5 DISPLAYS ONLY RESULT OF TEST (P OR F) FOR EACH TEST
- 6 VOLTAGE READING DISPLAYED TO THE NEAREST .5V INCREMENT, AT OR BELOW MEASURED VOLTAGE LEVEL. IF OPTION NOT INSTALLED, READING INDICATES BATTERY CIRCUIT CHARGE
- 7 RATE - 300 / 600 / 1200 / 2400 / 4800 / 9600 / 19200
- 8 MODE - ODD / EVEN / NONE
- 9 DASHED LINE INDICATES OPTION

4-1 MENUS

A-7550 operating parameters are set using direct entries from the keyboard: as described in Section 3 or via menu operation. Enter menu operation by pressing "MENU" on the keyboard. Menus can be subsequently cleared from the CRT display by pressing "MENU" a second time or by pressing "Ø" on the keyboard when the "Master" menu is displayed in the menu "window" (i.e., the area of the CRT display where the menu appears).

4-1-1 MENU LEVELS

A-7550 menus operate on multiple levels (see Figure 4-1). The Master Menu is the only first level menu. It is used to select a second level menu. The selections are listed in the menu window (DISP, MODE, RCVR, FILTERS, SETUP and PLOT). Select a second level menu by pressing the NUMBERED KEY corresponding with the number listed in the menu window left of the desired menu.

Two second level menus can be used to select third level menus. The FILTERS menu can be used to select the QUASI-PEAK menu. The SETUP menu can be used to select the REMOTE, MANUAL and TEST menus. Also, some menus can be selected only if a particular option is installed (QUASI-PEAK, RCVR or REMOTE). If one of these menus is selected and the option is not installed, the OPTION NOT INSTALLED menu appears in the menu window.

NOTE

The REMOTE menu displays either the RS-232 menu or the GPIB menu, when selected, if either option is installed.

Return to the previous menu level by pressing Ø (RETURN) on the keyboard. Pressing the MENU Key twice in succession during menu operation causes the Master Menu to appear in the menu window.

4-1-2 MENU OPERATION NOTES

1. The figures in this section are to illustrate the various A-7550 MENUS. Parameter values and waveforms should be ignored in every instance -- unless specifically referred to in the text.
2. The key shown next to each paragraph is that key required to select the corresponding function in the menu.

4-2 MASTER MENU

To enter menu operation, press the MENU key once. All other menus on the A-7550 are directly or indirectly selected from the Master Menu.

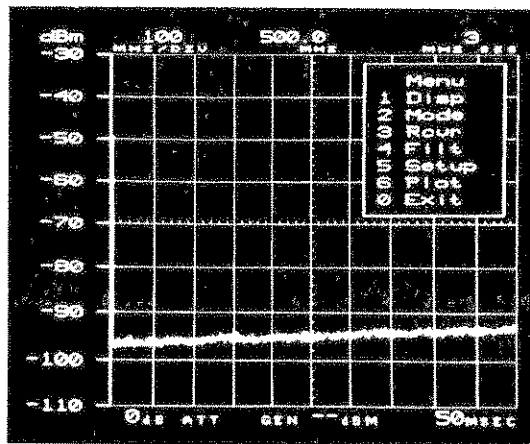





Figure 4-2 Master Menu

-  To select the CRT Display (DISP) Menu, press "1" on the keyboard. The DISP Menu is discussed in Paragraph 4-3. To return to the Master Menu, press "0" on the keyboard.
-  To select the Signal Display (MODE) Menu, press "2" on the keyboard. The MODE Menu is discussed in Paragraph 4-4. To return to the Master Menu, press "0" on the keyboard.
-  To select the Receiver Bandwidth (RCVR) Menu, press "3" on the keyboard. The RCVR Menu is discussed in Paragraph 4-5. If the 10.7 MHz Receiver is not installed in the A-7550, refer to Paragraph 4-12. To return to the Master Menu, press "0" on the keyboard.
-  To select the Video and Quasi-Peak FILTERS Menu, press "4" on the keyboard. The FILTERS Menu is discussed in Paragraph 4-6. To return to the Master Menu, press "0" on the keyboard.

- 5

 To select the SETUP Menu, press "5" on the keyboard. The SETUP Menu is discussed in Paragraph 4-7. To return to the Master Menu, press "0" on the keyboard.
- 6

 To draw a stored trace using the PLOT Menu, press "6" on the keyboard. The PLOT Menu is discussed in Paragraph 4-11. To return to the Master Menu, press "0" on the keyboard.

NOTE

The PLOT Menu can be used only when the GPIB option is installed (see Paragraph 4-12).

4-3 DISPLAY (DISP) MENU

To select the Display (DISP) Menu, press "1" on the keyboard when the Master Menu appears in the menu window. To select a display function, the DISP Menu must appear in the menu window. The arrow in the menu window points to the current menu selection (e.g., "REF" in Figure 4-3).

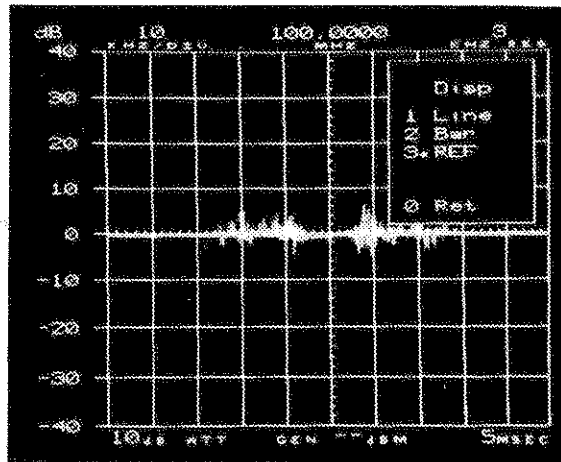

Figure 4-3 DISPLAY (DISP) Menu

- 1

 To select LINE display, press "1" on the keyboard. This causes the Analyzer Trace to be represented as a solid line.
- 2

 To select BAR display, press "2" on the keyboard. This causes the Analyzer Trace to be represented as a shaded area on the CRT.
- 3

 To select REF display, press "3" on the keyboard. The REF display shows a signal display which represents the difference between a live trace and a stored trace. (Live and Stored traces are discussed in Paragraph 4-4).

NOTE

When REF mode is selected, the entire display changes to display 0 dB as a reference at the center graticule (see Figure 4-3). Returning to LINE or BAR display mode returns the scale and unit to their previous settings.

NOTE

Select LINE display mode (Press 1) before returning to the Master Menu.



To return to the Master Menu, press "0" on the keyboard.

4-4 MODE MENU

To select the MODE Menu, press "2" on the keyboard when the Master Menu appears in the menu window. The MODE Menu must appear in the menu window before selecting a mode for signal display. The arrow in the menu window points to the current menu selection (e.g., "Live" in Figure 4-4).

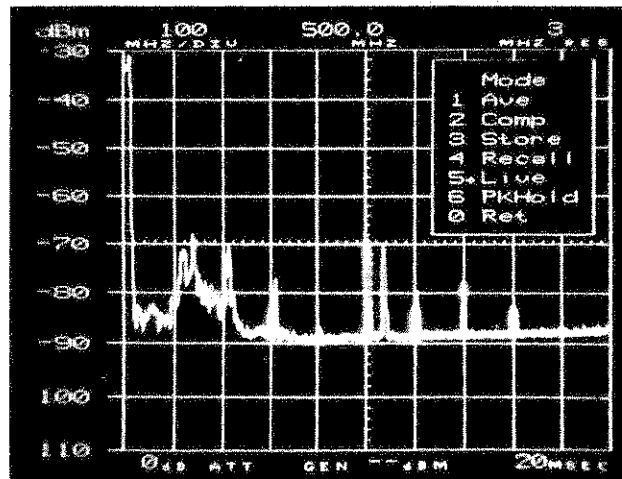

Figure 4-4 MODE Menu



To select AVE (Average) mode, press "1" on the keyboard. In this mode, the last three sweeps are averaged with the current sweep (i.e., four sweeps), which are continuously updated to reflect the average.



To select COMP (Compare) Mode, press "2" on the keyboard. The trace stored in memory is compared to and displayed with the current (live) trace. The shaded area is the difference between the live and stored traces. Selecting COMP automatically sets the DISPLAY Menu to BAR.



To select STORE Mode, press "3" on the keyboard. The current trace and display parameters are stored.

NOTE

When store is selected, the arrow in the menu window momentarily points to "3" and returns to the previous selection.



To select RECALL Mode, press "4" on the keyboard. The stored trace, with its parameters, are recalled and displayed on the CRT. Changing any parameter after selecting RECALL results in the A-7550 switching to LIVE Mode.

NOTE

The Video Filter Indicator is displayed on the CRT if a Video Filter is active when RECALL Mode is selected. The active indicator is displayed even if it was inactive when the recalled trace was stored.



To select LIVE Mode, press "5" on the keyboard. This is the normal mode of operation.



To select PKHOLD (Peak Hold) Mode, press "6" on the keyboard. PKHOLD Mode continually stores and displays maximum signal amplitude. The difference between the current signal and the maximum signal is displayed as a shaded area.

NOTE

Select LIVE mode (press ) before returning

to the Master Menu.



To return to the Master Menu, press "0" on the keyboard.

4-5 RCVR MENU

To select the RCVR (Receiver) Menu, press "3" on the keyboard when the Master Menu appears in the menu window. The RCVR Menu only appears if the 10.7 MHz Receiver is installed in the A-7550. Otherwise, the OPTION NOT INSTALLED menu (see Paragraph 4-12) appears in the menu window when this menu is selected. The RCVR Menu must appear in the menu window before selecting a receiver option. The arrow in the menu window points to the current menu selection, (e.g., "FM1" in Figure 4-5 except the TSR selection).

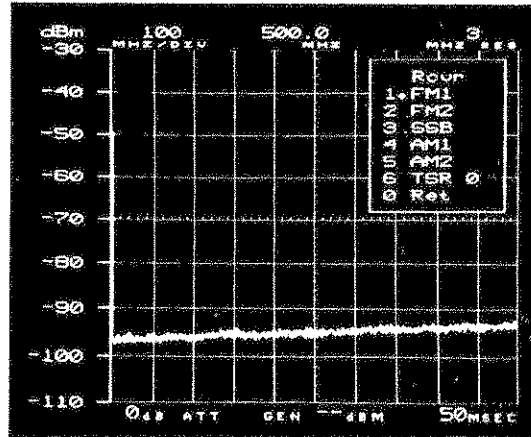

Figure 4-5 RCVR Menu



To select the FM1 (15 kHz narrow band) Receiver Bandwidth, press "1" on the keyboard.



To select the FM2 (200 kHz wide band) Receiver Bandwidth, press "2" on the keyboard.



To select the SSB (6 kHz Single Side Band) Receiver Bandwidth, press "3" on the keyboard.



To select the AM1 (6 kHz narrow band) Receiver Bandwidth, press "4" on the keyboard.



To select the AM2 (15 kHz wide band) Receiver Bandwidth, press "5" on the keyboard.



To select Time Share Reception ON (TSR = 1) or OFF (TSR = 0), press "6" on the keyboard. When TSR is on, the A-7550 sweeps the frequency spectrum for ONE FULL SWEEP; it then locks into Center Frequency for ONE FULL SECOND, to allow audio to be heard. The controller is then updated and another full sweep is taken, repeating the cycle. If TSR is inactive, zero scan width must be selected for fixed-tune operation. (See NOTE on next page.)

NOTE

During TSR operation, the speaker sounds increasingly disrupted as the sweep time becomes slower. Also, CERTAIN KEYS MAY APPEAR TO HAVE AN ACTION DELAY AS KEY ENTRIES ATTEMPTED DURING AUDIO RECEPTION ARE IGNORED (i.e., they are locked out by the controller).

NOTE

Set TSR to 0. Then select the receiver bandwidth you wish to use for operation before returning to the Master Menu.



To return to the Master Menu, press "0" on the keyboard.

4-6 FILTERS MENU

To select the FILTERS Menu, press "4" on the keyboard when the Master Menu appears in the menu window. The FILTERS Menu must appear in the menu window to select a filter. The arrow in the menu window points to the current menu selection (e.g., 30K in Figure 4-6).

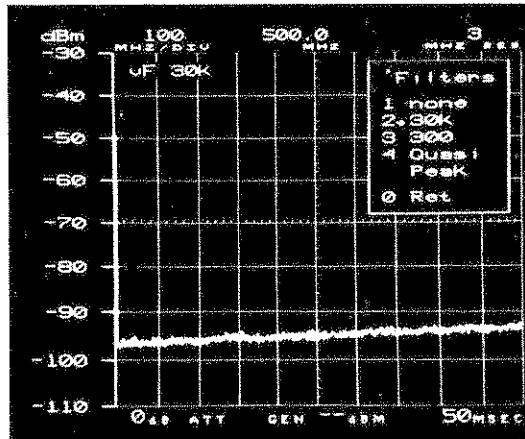

Figure 4-6 FILTERS Menu

4-6-1 VIDEO FILTER INDICATOR

If a video filter is selected, the selected filter value (30 kHz or 300 Hz) is displayed in the upper-left quadrant of the CRT screen (see Figure 4-6). If the filter display is on the screen, then the video filter is active.

4-6-2 FILTERS MENU SELECTIONS



To select NO FILTERING (NONE), press "1" on the keyboard.



To select the 30 kHz Video Filter, press "2" on the keyboard. When the 30 kHz Video Filter is selected, Sweep Rate Optimization may occur. Refer to Table E-4 for details.



To select the 300 Hz Video Filter, press "3" on the keyboard. When the 300 Hz Video Filter is selected, Sweep Rate Optimization may occur. Refer to Table E-3 for details.



The Quasi-Peak Menu, described in Paragraph 4-6-3, can only be selected when the Quasi-Peak option is installed.

NOTE

Select "NONE" (Press ) for operation before

returning to the Master Menu.



To return to the Master Menu, press "0" on the keyboard.

4-6-3 QUASI-PEAK FILTER MENU

To select the QUASI-PEAK Menu, press "4" on the keyboard when the FILTERS Menu appears in the menu window. The Quasi-Peak Menu appears only if the Quasi-Peak Detector is installed in the A-7550. Otherwise, the OPTION NOT INSTALLED menu appears in the menu window. The Quasi-Peak Menu must appear in the menu window before selecting a Quasi-Peak function (see Section 7 for full operation details). The arrow in the menu window points to the current menu selection (e.g., "TC3" in Figure 4-7).

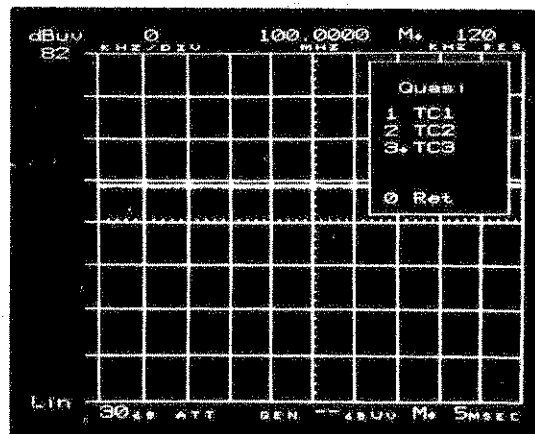

Figure 4-7 QUASI-PEAK Menu

NOTE

When Quasi-Peak is selected:

1. The microprocessor automatically sets the video filter to "NONE" (i.e., no video filter).
2. Optimization occurs to conform the Resolution Bandwidth and Sweep Rate to the Time Constant selection. These settings remain until another FILTERS Menu selection is made.
3. When the Quasi-Peak Detector is turned off (i.e., another filter or no filter is selected), the Resolution Bandwidth is automatically reset to the next highest setting. For example, if TC1 is used during Quasi-Peak operation, when the Quasi-Peak Detector is turned off, the Resolution Bandwidth will be reset to 300 Hz.



To select TC1 (Time Constant 1), press "1" on the keyboard when the Quasi-Peak Menu appears in the menu window. TC1 provides the charge and discharge time required for Quasi-Peak measurements from 10 kHz to 150 kHz and sets the Resolution Bandwidth to 200 Hz.



To select TC2 (Time Constant 2), press "2" on the keyboard when the Quasi-Peak Menu appears in the menu window. TC2 provides the charge and discharge time required for Quasi-Peak measurements from 150 kHz to 30 MHz and sets the Resolution Bandwidth to 9 kHz.



To select TC3 (Time Constant 3), press "3" on the keyboard when the Quasi-Peak Menu appears in the menu window. TC3 provides the charge and discharge time required for Quasi-Peak measurements from 30 MHz to 1 GHz and sets the Resolution Bandwidth to 120 kHz.



To return to the FILTERS Menu, press "0" on the keyboard and select "NONE" (press ).

4-7 SETUP MENU

To select the SETUP Menu, press "5" on the keyboard when the Master Menu appears in the menu window. The SETUP Menu must appear in the menu window before selecting SETUP functions (see Figure 4-8).

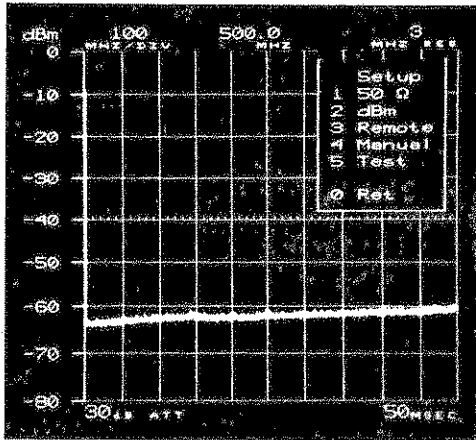

(a) SETUP Menu Without Tracking Generator

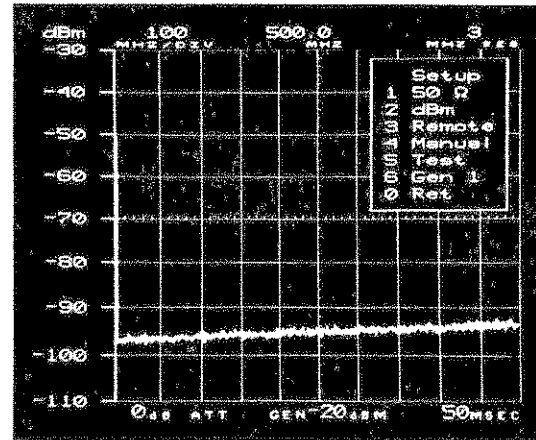

(b) SETUP Menu With Tracking Generator

Figure 4-8 SETUP Menus



Press "1" on the keyboard, to select 50 Ω or 75 Ω operation. The current impedance selection is displayed in the menu window (see Table 3-1). Set this parameter to 50 Ω operation.

NOTE

Changing the menu setting does not change the impedance! A 50 to 75 Ω adapter must be connected to the ANALYZER INPUT Connector (10) to operate the A-7550 at 75 Ω . Also, if using a Tracking Generator, a second 50 to 75 Ω adapter must be connected to the Generate Output Connector (7), for 75 Ω operation.



To reset the graticule unit, press "2" on the keyboard. The following units are selectable on the A-7550: dBm, dBmV, dBuV, dBV or dBuW. The current setting is displayed in the menu window. See Table 3-1 for Graticule Label differences when changing the unit. Set this parameter to "dBm".



To select the REMOTE operating mode described in Paragraph 4-8, press "3" on the keyboard. If neither Remote Option is installed (i.e., GPIB or RS-232), the OPTION NOT INSTALLED Menu appears in the Menu Window (see Paragraph 4-12).



To select the MANUAL Menu described in Paragraph 4-9, press "4" on the keyboard.



To select the TEST Menu described in Paragraph 4-10, press "5" on the keyboard.



To set the Tracking Generator ON (Gen = 1) or OFF (Gen = 0), press "6" on the keyboard. The Tracking Generator must be installed in the A-7550 for this selection to appear in the SETUP Menu window (see Figures 4-8(a) and 4-8(b)). The unit in the Tracking Generator display corresponds with the Unit

Display and the Menu Window display (as set in Item ).

NOTE

It is recommended to set the Tracking Generator OFF (GEN = 0), unless specific measurements are being made with it.



To return to the Master Menu, press "0" on the keyboard.

4-8 REMOTE MENU

To select the REMOTE Menu, press "3" on the keyboard when the SETUP Menu appears in the menu window. When REMOTE is selected, the menu appearing in the menu window depends on the option installed in the A-7550:

- The GPIB Menu appears when the GPIB option (Option 05) is installed (see Paragraph 4-8-1).
- The RS-232 Menu appears when the RS-232 option (Option 06) is installed (see Paragraph 4-8-2).
- The OPTION NOT INSTALLED Menu appears when neither the GPIB nor the RS-232 option is installed (see Paragraph 4-12).

4-8-1 GPIB MENU

The GPIB Menu appears when the REMOTE Menu is selected and the GPIB option is installed. The GPIB Menu must appear in the menu window before the GPIB Address can be set (see Figure 4-9). The GPIB Address used must match the address specified in the interfacing software.

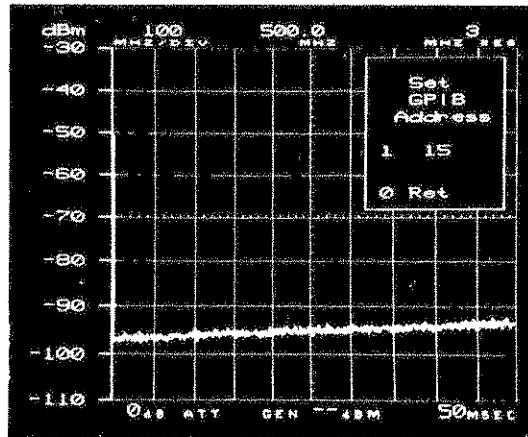

Figure 4-9 GPIB Menu



To select the GPIB Address, press "1" on the keyboard until the desired address appears in the menu window. The range of this address is from 00 to 31 (decimal values).



To return to the SETUP Menu, press "0" on the keyboard.

4-8-2 RS-232 MENU

The RS-232 Menu appears when the REMOTE Menu is selected and the RS-232 option is installed in the A-7550. The RS-232 Menu must appear in the menu window before RS-232 options can be set (see Figure 4-10).

NOTE

Refer to the COMMUNICATIONS Section of the external controller's manual before setting these parameters.

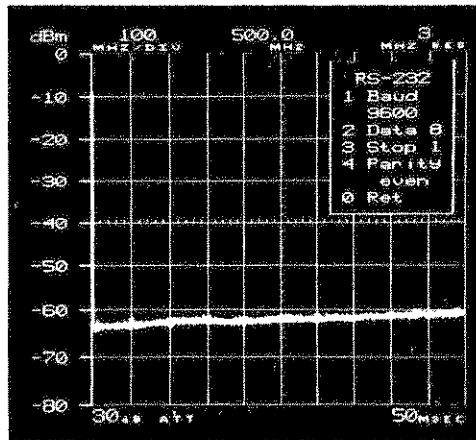







Figure 4-10 RS-232 Menu

-  To select the Baud Rate, press "1" on the keyboard until the desired Baud Rate appears in the menu window. The following Baud Rates are available on the A-7550: 300, 600, 1200, 2400, 4800, 9600 and 19200 baud. The current setting is displayed in the menu window.
-  To set the number of Data Bits per word, press "2" on the keyboard until the desired setting appears in the menu window. Data Bits can be set to 7 or 8. The current selection is displayed in the menu window.
-  To set the number of Stop Bits per word, press "3" on the keyboard until the desired setting appears in the menu window. Stop Bits can be set to 1 or 2. The current setting is displayed in the menu window.
-  To select the mode of Parity Check, press "4" on the keyboard until the desired mode appears in the menu window. Parity can be set to ODD, EVEN or NONE. The current setting is displayed in the menu window.
-  To return to the SETUP Menu, press "0" on the keyboard.

4-9 MANUAL MENU

To select the MANUAL Menu, press "4" on the keyboard when the SETUP Menu appears in the menu window. The MANUAL Menu must appear in the menu window before MANUAL Menu parameters can be set (see Figure 4-11).

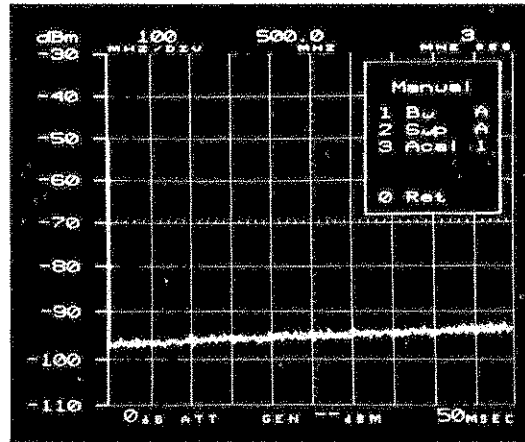

Figure 4-11 MANUAL Menu

NOTE

A-7550 optimization is discussed in Appendix E.



To turn Bandwidth Optimization ON (Bw = A) or OFF (Bw = M), press "1" on the keyboard. When Bandwidth Optimization is ON, the Resolution Bandwidth may change when the Center Frequency or Scan Width is changed. When Bandwidth Optimization is OFF, changing the Center Frequency or the Scan Width does not change the Resolution Bandwidth. "M+" is displayed next to the resolution bandwidth display when Bandwidth Optimization is turned OFF. Set Bw to A.



To turn Sweep Rate Optimization ON (Swp = A) or OFF (Swp = M), press "2" on the keyboard. When Sweep Rate Optimization is ON, the Sweep Rate may change when the Center Frequency, Scan Width or Resolution Bandwidth is changed. When Sweep Rate optimization is OFF, changing the Center Frequency, the Scan Width or the Resolution Bandwidth does not change the Sweep Rate. "M+" is displayed next to the Sweep Rate display when Bandwidth Optimization is turned OFF. Set Swp to A.



To turn the Auto Cal function ON (Acal = 1) or OFF (Acal = 0), press "3" on the keyboard. Setting Auto Cal OFF disables the Auto Cal feature, and displays "Ac" between the Scan Width and Center Frequency display blocks across the top of the CRT display. Returning to the ON state forces one Auto Cal cycle. Set Acal to 1.



To return to the SETUP Menu, press "0" on the keyboard.

4-10 TEST MENU

To select the TEST Menu, press "5" on the keyboard when the SETUP Menu appears in the menu window. When selected, all tests are automatically run. Once the tests are completed, any test can be rerun by pressing the number on the keyboard corresponding with the number of the desired test in the menu window. A passed test is indicated by "P" displayed to the right of the test in the menu window (see Figure 4-12). A failed test is indicated by "F" displayed in reverse video to the right of the test in the menu window.

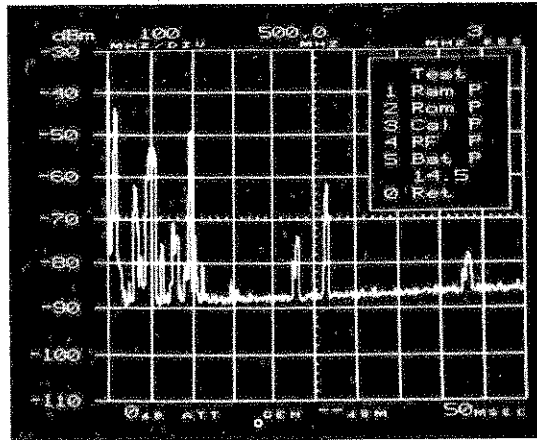

Figure 4-12 TEST Menu



To rerun the RAM test only, press "1" on the keyboard. This tests system RAM, CRT alpha RAM, and the Dual-port RAM. If all RAM tests pass, "P" is displayed in the menu window next to the RAM test. If any of the tests fail, they are indicated in reverse video as follows:

- F1 - System RAM on Control Processor Board failure;
- F2 - CRT alpha RAM on Video Processor Board failure;
- F3 - Dual-port RAM on Video Processor Board failure.



To rerun the ROM test only, press "2" on the keyboard. This performs a checksum test on the system firmware.



To rerun the CAL test only, press "3" on the keyboard. This tests the Auto Cal subsystem.



To rerun the RF test only, press "4" on the keyboard. This tests the microprocessor communication between the RF Interface and all PC Boards. Phase lock condition is indicated by "P"; otherwise, the test fails.



To rerun the BATT test only, press "5" on the keyboard. This checks the battery charge level and displays the voltage in 0.5 V intervals (rounded down) of the measured voltage. If below +12 V, a failure condition is indicated.

NOTE

When the battery test is performed and the battery is not installed, a voltage reading of the Battery Charge Circuit is taken. The battery test should pass and the reading should be 14.5 V.



To return to the SETUP Menu, press "0" on the keyboard.

4-11 PLOT MENU

Use of the Plotter requires GPIB installation; otherwise, the OPTION NOT INSTALLED Menu is displayed in the menu window (see Paragraph 4-12). To select the PLOT Menu, press "6" on the keyboard when the Master Menu appears in the menu window.

4-11-1 PLOTTER INSTALLATION

Before plots can be generated, attach a GPIB cable between the GPIB Connector (37) on the Rear Panel of the A-7550 and the GPIB Connector of any HP-GL™ (Hewlett-Packard Graphics Language) compatible plotter. Set the plotter to LISTEN ONLY mode.

NOTE

The Plotter is configured as a Listen Only device and will receive commands from any controller connected to the GPIB Bus. Therefore, ensure any GPIB Controller is disconnected before generating direct plots.

4-11-2 PLOTTER OPERATION

The plotter function plots a graph of the stored trace (select MODE Menu, press "3"). During plotter operation, the arrow in the menu window points to the function in use -- only when it is in operation. The arrow disappears when a task completes (see Figure 4-13).

When using a single pen plotter, if more than one color is desired for the plot, the stylus must be changed manually between plotter functions. If this is the case, use menu functions 1, 2 and 3 during plotter operation. (If only one color is being used for the entire plot, menu function 5 (Auto) may be used for uninterrupted plotter operation.

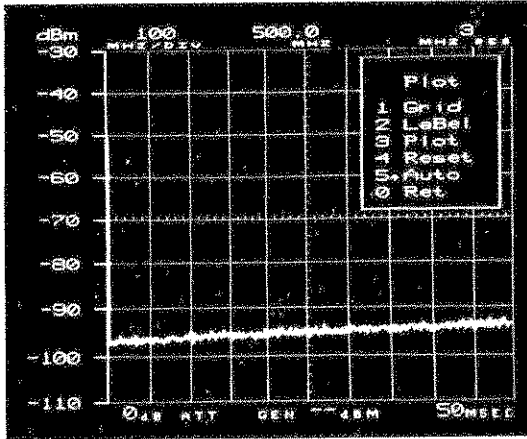

(a) Plot Menu During Plotter Activity

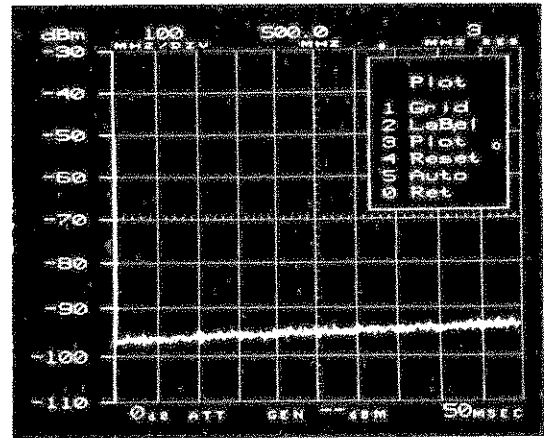

(b) Plot Menu When Waiting for Activity

Figure 4-13 PLOT Menus

When using a multiple pen plotter:

- Pen 1 is used to draw the trace only;
- Pen 2 is used to draw the grid, parameter labels and values;
- Pen 1 and Pen 2 MUST be inserted for proper plotter operation;
- The Auto Menu function (menu function "5") may be used for uninterrupted operation.

4-11-3 PLOT MENU FUNCTIONS



To draw the grid on the plotter, press "1" on the keyboard. This grid represents all graticules and tick markings of the A-7550.



To draw labels and parameter values of the stored trace, press "2" on the keyboard.



To draw the stored trace on the plotter, press "3" on the keyboard.



To stop any of the above functions before completion, press "4" on the keyboard. If the function is subsequently rerun, the plotter begins to draw at the starting position of the selected function.



The Auto selection performs the functions of selections 1, 2 and 3 without interruption. Press "5" on the keyboard to select "auto" operation.



To return to the Master Menu, press "0" on the keyboard.

4-12 OPTION NOT INSTALLED MENU

OPTION NOT INSTALLED is a message menu that appears when a selected option is not installed in the A-7550. For example, if the RCVR Menu is selected and the 10.7 MHz Receiver is not in the unit, OPTION NOT INSTALLED will be displayed in the menu window (see Figure 4-14).

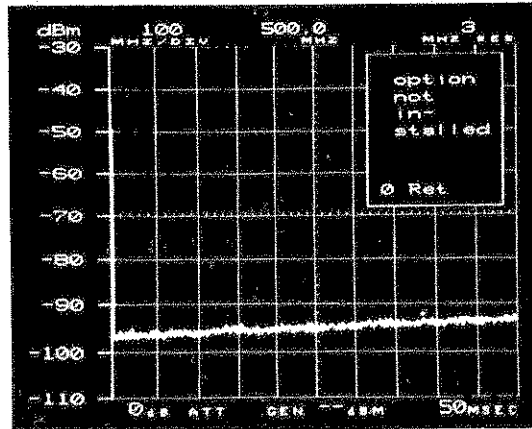

Figure 4-14 OPTION NOT INSTALLED Menu



Press "0" on the keyboard to return to the previous menu.

SECTION 5 - GPIB OPERATION

5-1 REMOTE (GPIB) OPERATION

Remote communication with the A-7550 is available by using the General Purpose Interface Bus (GPIB). This option conforms to IEEE Standard 488-1978. The test set conforms with the following IEEE Subsets: SH1, AH1, T6, TEO, LA, LEO, SR1, RL2, PPO, DC1, DT1 and CO. These subsets allow the A-7550 to perform the following functions:

- Complete Source and Acceptor Handshake
- Talker with Serial Poll
- Listener
- Service Request
- Remote/local (No local lockout capability)
- Device Clear

The GPIB Address is set in the GPIB Menu.

All communication with the A-7550 through the GPIB requires ASCII encoded character strings. Invalid or improperly formatted characters are discarded and cause an error status bit to be set. Exceptions to this are the IEEE-488 BUS Messages defined in Table 5-2. These messages require immediate attention from the A-7550 to continue processing character strings. The commands are stored in a 128-byte buffer until one of the following messages is received: Carriage Return, Line Feed, Null Character, "END" or "IDY". All commands are then run and measurements made or initiated.

All A-7550 responses returned across IEEE-488 1978 channels are ASCII encoded character strings ending with both CARRIAGE RETURN and LINE FEED commands. (Some controllers may ignore one of these commands.) The EOI message is imparted with the LINE FEED Command.

NOTE

Some command responses (e.g., MODE=STORE: GET(XX)?) have longer than average controller response times. This is expected, and the input time-out parameters for IEEE-488 1978 Controllers should be set to at least thirty seconds.

5-1-1 PREPARATION FOR USING GPIB

When the GPIB option is installed, a 24-pin connector is provided on the rear panel for connecting the A-7550 to an external controller (see Figure 5-1).

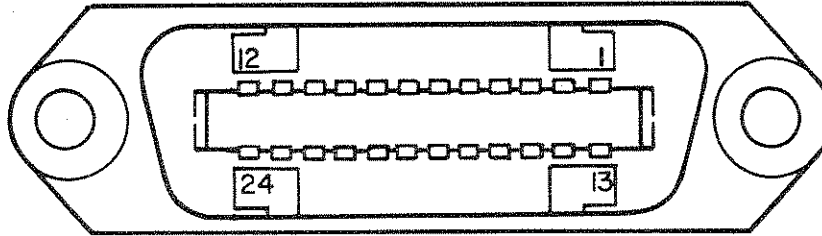

Figure 5-1 GPIB Connector

GPIB Connector pinouts are defined in Table 5-1.

Pin No.	Signal	Pin No.	Signal
1	DIO 1	13	DIO 5
2	DIO 2	14	DIO 6
3	DIO 3	15	DIO 7
4	DIO 4	16	DIO 8
5	EOI	17	REN
6	DAV	18	Ground
7	NRF D	19	Ground
8	NDAC	20	Ground
9	IFC	21	Ground
10	SRQ	22	Ground
11	ATN	23	Ground
12	Ground	24	Ground

Table 5-1 Pinout Table for GPIB Connector

Once the proper connection is made, the A-7550 can be initialized with the proper address using the GPIB Menu. Refer to Paragraph 4-9-1 for the GPIB Menu instructions.

MNEMONIC MESSAGE	ASCII CODE (HEX)	IEEE-488 INSTRUCTION DEFINITION (SEE NOTE)
ATN	bus signal line	ATTENTION
DAB	00-7F	Data Byte
DAC	bus signal line	Data Accepted
DAV	bus signal line	Data Valid
DCL	14	Device Clear
END or EOI	bus signal line	End
GET	08	Group execute trigger
GTL	01	Go to Local
IDY	bus signal line	Identify
IFC	bus signal line	Interface clear
LLO	11	Local Lockout
MLA	20-3F	My listen address
MTA	40-5F	My talk address
REN	bus signal line	Remote enable
RFD	bus signal line	Ready for data
SPD	19	Serial poll disable
SPE	18	Serial poll enable
SRQ	bus signal line	Service Request
STB	00-FF	Status Byte
UNL	3F	Unlisten
UNT	5F	Untalk

Table 5-2 IEEE-488 1978 BUS Messages

NOTE

Refer to the IEEE-Standard 488-1978 for full definitions.

5-1-2 A-7550 AND GPIB MESSAGE INTERFACE

Following are A-7550 responses to external controller requests during remote communication. Table 5-2 defines each of the mnemonic messages.

ATN	The A-7550 GPIB I/O device responds immediately to process the incoming GPIB controller commands.
DAB	The A-7550 microprocessor responds by status testing of the GPIB I/O device to accept the data byte.
DAC	The A-7550 GPIB I/O device responds immediately to signal the talker that it has accepted the data byte.
DAV	The A-7550 GPIB I/O device responds immediately to signal the interceptor that it has put valid data on the BUS.
DCL	The A-7550 processor responds to reset the test set to its initialized state.
END or EOI	The A-7550 responds to terminate the command input from the source and begin processing the commands available up to the last valid delimiter.
GET	The A-7550 responds to terminate any further inputs and executes the commands available up to the last available delimiter.
GTL	The A-7550 processor responds to remove itself from control over the test set, therefore returning control to the front panel.
IDY	Same as "END" or "EOI".
IFC	The A-7550 processor responds by returning to local mode.
LLO	No response to this message.
MLA	The A-7550 GPIB I/O device responds immediately by comparing its address with the given listen address. If the two are the same, it instructs the processor to listen.
MTA	The A-7550 GPIB I/O device compares its address with the talk address given. If the two are the same, it instructs the processor to talk.
REN	The A-7550 processor responds from the interface to put the test set into remote, which disables front panel operation.
RFD	The A-7550 GPIB I/O device signals the source that it is ready for data to be transmitted on the bus.
SPD	The A-7550 GPIB I/O device terminates the service request operation by disabling the serial poll.

- SPE The A-7550 GPIB I/O device places the status byte on the BUS addressed to talk.
- SRQ The A-7550 processor instructs the interface to signal the controller that servicing is desired. (This is done under A-7550 software control.)
- STB The A-7550 GPIB I/O device responds immediately after the SPE and MTA messages by placing the status byte on the BUS.
- UNL The A-7550 GPIB I/O device and the processor respond to unlisten the test set.
- UNT The A-7550 GPIB I/O device and the processor respond to untalk the test set.

5-1-3 GPIB TRANSACTIONS

Following are examples of GPIB transactions showing the ASCII Character String to be transmitted and the corresponding BUS operations required to complete the communication. These examples were generated and run using a GPIB controller with a BASIC Interpreter. Enhancements to the controller allowed direct communication across the GPIB using special GPIB interface hardware.

In the examples, Step 1 shows the transmitted ASCII character string. Step 2 shows the bus operations required to complete the transaction.

- A. Example No. 1 - Instruct the A-7550 to set the RF to 500 MHz.
1. ASCII String: "RFF = 500" (Followed by carriage return and line feed.)
 2. BUS Transaction: UNT, UNL, MTA, DAB "R", DAB "F", DAB "F", DAB "=", DAB "5", DAB "0", DAB "0", DAB CR, DAB LF.
- B. Example No. 2 - Instruct the A-7550 to return the RF Attenuation which is -10 dB.
1. ASCII String: "RFATN?"
 2. BUS Transaction:
 - a. Output Cycle - UNT, UNL, MLA, MTA, DAB "R", DAB "F", DAB "A", DAB "T", DAB "N", DAB "?", DAB CR, DAB LF.
 - b. Input Cycle - UNT, UNL, MLA, MTA, DAB "1", DAB "0", DAB CR, DAB LF.

5-1-4 STATUS AND SERVICE REQUEST TRANSACTIONS

The A-7550 has the capability to trigger a service request, based on one to six trigger conditions which can be set by the user with the "SRQ=" command. After the A-7550 is connected to the controller, it may be interrogated for the one byte status information. If an internal error or status condition becomes true and the matching trigger bit of the SRQ trigger byte (bits 0 through 5) has been set, bit 6 is also set. Bit 6 is generally used as the service request bit, signaling the GPIB controller that the A-7550 desires servicing. For definitions of how status bits are set, see Table 5-3.

STATUS BIT NO.	STATE	DEFINITION
0	00000001	RAM Error
1	00000010	ROM Error
2	00000100	Autocal test failure
3	00001000	RF test failure
4	00010000	To be defined
5	00100000	A-7550 recognizes remote state
6	01000000	Service Request Bit
7	10000000	ERROR - a command error has occurred

Table 5-3 Status Bit Definition

5-2 COMMAND AND DATA STRUCTURE

All A-7550 functional commands and data information are transferred over the GPIB as uppercase ASCII Alphanumeric Character Strings and are designed to replace the front panel controls.

5-2-1 GPIB COMMANDS TO THE A-7550

All commands sent to the A-7550 are placed in an internal queue that can accommodate up to 128 bytes of data. Command Strings may be packed together, but the individual commands must be separated by delimiters. The delimiters are:

ASCII COLON ":" or some other assigned ASCII character

ASCII PERIOD "."

ASCII QUESTION MARK "?"

NOTE

The Question Mark ("?") is accepted at any time, but it is ignored unless it follows a command. This allows the user to continually interrogate the output buffer when waiting for a measurement. Do not use the Question Mark as a general delimiter.

The Period (".") can be used at any time, but is ignored unless used with the designated commands or as a decimal. Avoid using the period as a general delimiter.

The general delimiter is assigned using the DEL= Command. This can be any valid ASCII character with a decimal equivalent of 0 to 127 (e.g., comma (",") = 44, colon (":") = 58 and semicolon (";") = 59.

To avoid confusion or ambiguity, certain characters should not be assigned as delimiters. These include the period, question mark and all numeric and alphabetic characters.

The following ASCII Characters terminate the output command or series of commands:

Carriage Return (OD) - CR
Line Feed (OA) - LF
NULL Character (0) - NL

When the A-7550 is assigned talker, the EOI line is set when line feed (OA) is sent.

NOTE

The external GPIB controller must be programmed to expect an ASCII line feed (OA) character as the termination character of the input string.

5-2-2 GPIB COMMAND DATA FORMAT

All spaces are ignored by the controller. Following are some valid command examples:

SWEEPR = 100: SWEEPR?
SCANW?
RFATN = 10

NOTE

One of the following line terminators should be included at the end of every line to prevent execution errors from occurring: CR, LF, NL or EOI.

Maximum command string length, including spaces and delimiters, is 128 characters. If the command string exceeds this length, only those commands prior to the last delimiter and preceding the 128th character are performed. Commands past that delimiter are truncated and the Error Status bit ("7") is then set. Commands ending with an ASCII Question Mark ("?") normally require the user to enter an ASCII String Input Command after issuing an output command.

EXAMPLE:

```
COMMAND: RFF?SCANW?RID=ON:RFATN?  
RESPONSE: 500:100:RFATN = 10
```

These commands set the Reply Identifier Flag which causes the command label following "RID=ON" to be attached to the response.

5-2-3 RETURN DATA FORMAT

The returned data format convention is similar to the Output Command Data Format in that all returns are packed and separated by the assigned general delimiter(s) and must end with CARRIAGE RETURN and LINE FEED Commands. The number of responses returned is determined by the number of commands transferred in one block. If the number of responses required causes the internal response buffer to overflow, because it exceeds 128 characters, then only those characters up to the last delimiter before the 128th character are returned.

Input data that is out of range generally defaults to the minimum value(s) or the initialized value(s).

Figure 5-2 shows a reconstructed output produced by an IEEE-488 1978 controller. The requested parameters are listed to the right of the output sample.

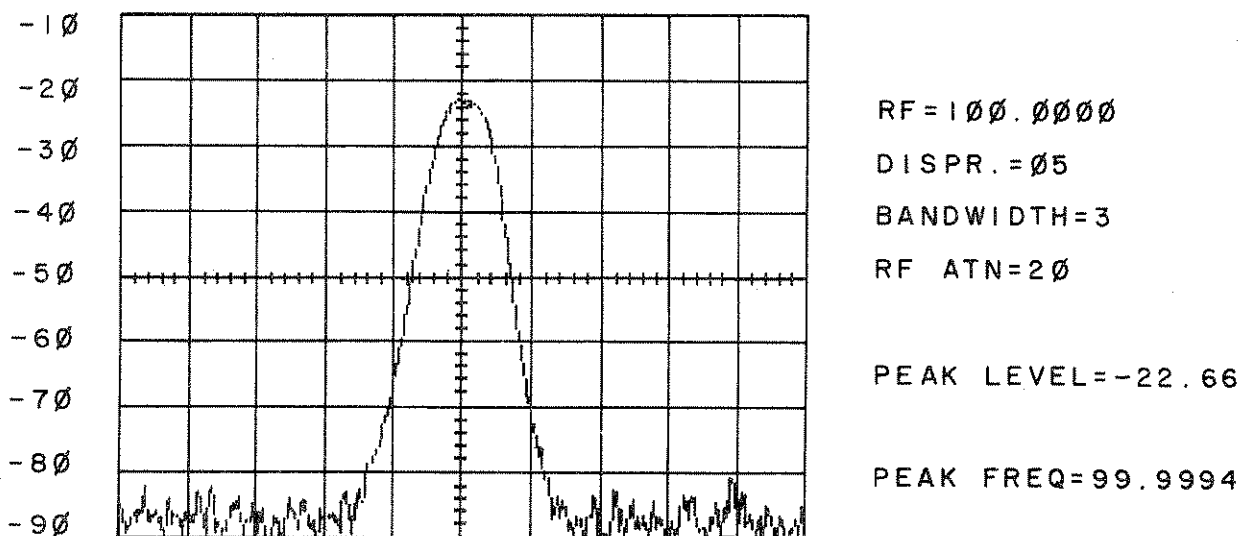

Figure 5-2 IEEE-488 1978 Display Output

5-2-4 REPLY IDENTIFIER

When the Reply Identifier is activated by the command "RID=ON", the returned information for data or status requests are preceded by the command mnemonic and an "=" character. This continues until the command "RID=OFF" is issued or the A-7550 power is cycled. This feature is especially useful for identifying measured data returned after a time delay, or from a string of commands.

5-3 A-7550 COMMAND SET

Table 5-4 defines, in alphabetic order, the ASCII Commands used to control the A-7550 under GPIB operation. Delimiters for each command are used throughout the Table to define different command types:

- "=" represents a "set value to" operation for that command.
- "?" represents a "get value" operation for that command.
- "." represents an "enable" operation.

Items listed under the range column reflect data entered into or retrieved from the A-7550. Data shown in parentheses is data retrieved from the unit. Data not enclosed in parentheses is data being sent to the A-7550. A series of dashes means that the command is imperative (no data required as input or output).

NOTE

All commands and data entries must be numeric, one of the assigned delimiters, or an alphabetic (UPPERCASE or lowercase) character.

COMMAND	RANGE	DEFINITION
ACAL	----	Forces one AutoCal cycle, if AutoCal enabled.
ACAL=	0,1	Disables (0) or Enables (1) Auto Cal feature.
ACAL?	(0,1)	Returns A Cal status (Enabled or Disabled)
BATT?	(11.0 to 15.0 V, 0.5 V steps)	Returns Battery voltage.
BW=	.3,3,30,300,3000 kHz	Set Resolution B/W
BW?	(.3,3,30,300,3000 kHz)	Get Resolution B/W
BWC=	A or M	Disable (M) or Enable (A) B/W optimization.
BWC?	(A or M)	Returns B/W optimization status.
DEL=	0 to 127, inclusive.	Sets the delimiter to the ASCII character represented by the assigned decimal number.
DEL?	(0 to 127)	Returns the decimal number for the ASCII delimiter character.
DISP=	LINE,BAR,REF	Sets display to one of three modes.
DISP?	(LINE,BAR,REF)	Returns display mode of A-7550.
GEN=	1,0	Set the generator on (1) or off (0).
GEN?	(1,0)	Return status of Gen Switch.
GENLVL=	0 to 70	Set generator output level. Depends upon "REF=" and "IMPD=" Command settings.

Table 5-4 A-7550 Instruction Set

NOTE

Range must be entered in numeric or alphabetic (UPPERCASE or lowercase) characters.

COMMAND	RANGE	DEFINITION
GENLVL?	(0 to 70)	Return generator output level setting.
GET(xx)?	(0-511)	Returns 10 points out of the 390 stored points from the last stored display beginning with data group xx (1-39). The returned points are separated by the delimiter assigned in the DEL= command (see Note 2).
IFGAIN=	0 to 65, step 1 dB	Set the IF GAIN to the designated value.
IFGAIN?	(0 to 65)	Get the IF GAIN value.
IMPD=	50,75	Set the impedance (in ohms).
IMPD?	(50,75)	Get the impedance value.
MIN? MIN(from)? MIN(from:to)?	(0-511:1-390)	Returns the minimum value of the last stored display for the specified horizontal range. The value is returned in the format: (yyy:xxx); where yyy is the minimum level (0 to 511) corresponding to the requested horizontal value(s) (1 to 390). The range returned can be in the following formats:

Table 5-4 (Continued) A-7550 Instruction Set

NOTE

1. Range must be entered in numeric or alphabetic (UPPERCASE or lowercase) characters.
2. When receiving display data points, values not displayed can be returned. When receiving a STORED REF trace, values can be negative or greater than 511, as this is a computed RATIO (i.e., (stored signal)/(input signal)).

COMMAND	RANGE	DEFINITION
MIN? (cont.)		<p>MIN? - The entire stored display is scanned for the minimum signal level.</p> <p>MIN(from)? - The stored display is scanned <u>from</u> the specified horizontal value to the end of the display.</p> <p>MIN(from:to) - The stored display is scanned <u>from</u> the first specified point <u>to</u> the second specified point.</p> <p style="text-align: center;">NOTE</p> <p>a. These points must be specified in proper sequence (that is, minimum value must be less than or equal to maximum value).</p> <p>b. The delimiter separating "from:to" and returned requests is assigned with the DEL= command.</p> <p>c. If no value precedes the delimiter, 1 is assumed to be the first assigned point.</p>
MODE=	AVE,COMP,STORE,RECALL,LIVE,PKHOLD	Sets A-7550 to selected mode.
MODE?	(AVE,COMP,STORE,RECALL,LIVE,PKHOLD)	Returns A-7550 mode.

Table 5-4 (Continued) A-7550 Instruction Set

NOTE

Range must be entered in numeric or alphabetic (UPPERCASE or lowercase) characters.

COMMAND	RANGE	DEFINITION
PEAK? PEAK(from)? PEAK(from:to)?	(0-511:1-390)	<p>Returns the peak value of the last stored display for the specified horizontal range. The value is returned in the format: (yyy:xxx); where yyy is the maximum level (0 to 511) corresponding to the requested horizontal value(s) (1 to 390). The range returned can be in the following formats:</p> <p>PEAK? - The entire stored display is scanned for the maximum signal level.</p> <p>PEAK(from)? - The stored display is scanned from the specified horizontal value to the end of the display.</p> <p>PEAK(from:to) - The stored display is scanned from the first specified point to the second specified point.</p> <p style="text-align: center;">NOTE</p> <p>a. These points must be specified in proper sequence (that is, minimum value must be less than or equal to maximum value).</p>

Table 5-4 (Continued) A-7550 Instruction Set

NOTE

Range must be entered in numeric or alphabetic (UPPERCASE or lowercase) characters.

COMMAND	RANGE	DEFINITION
		<p>b. The delimiter separating "from:to" and returned requests is assigned with the DEL= command.</p> <p>c. If no value precedes the delimiter, 1 is assumed to be the assigned point.</p>
PEAKF=	NONE,30K,300	Set peak filter value.
PEAKF?	(NONE,30K,300)	Get peak filter value.
PUT(xx)=	0-511	Sends 10 points to the A-7550 to be stored for display beginning with data group xx (1-39). The data must be valid numbers separated by the delimiter assigned with the DEL= command. To display the transferred information, the A-7550 must be in the "recall" mode.
QUASI=	TC1,TC2,TC3	Set Quasi-Peak filter value.
QUASI?	(TC1,TC2,TC3)	Return Quasi-Peak filter value.
RCVR=	FM1,FM2,SSB,AM1,AM2	Sets 10.7 MHz Receiver Modulation.
RCVR?	(FM1,FM2,SSB,AM1,AM2)	Returns 10.7 MHz Receiver Modulation.
REF=	DBM, DBUW, DBV, DBMV, or DBUV	Set scale reference label.
REF?	(DBM, DBUW, DBV, DBMV, or DBUV)	Return scale reference label.
RFATN=	0 to 60, step 10 dB	Set RF Input Attenuator level.

Table 5-4 (Continued) A-7550 Instruction Set

NOTE

Range must be entered in numeric or alphabetic (UPPERCASE or lowercase) characters.

COMMAND	RANGE	DEFINITION
RFATN?	(0 to 60, step 10 dB)	Get RF Input Attenuation level.
RFF=	000.0050 to 999.9999	Set Analyzer Frequency.
RFF?	(000.0050 to 999.9999)	Returns Analyzer Frequency.
RID=	ON/OFF	Controls the Reply Identifier Switch. When ON, adds the command name followed by "=" as a prefix to a command's response.
RID?	(ON/OFF)	Returns the current reply identifier status.
SCALE=	2, 10, LIN	Set Amplitude Scale
SCALE?	(2,10,LIN)	Get Amplitude Scale
SCANW=	0; .001 to 100 MHz/div in 1-2-5 sequence (see Note 2).	Set Frequency scan range.
SCANW?	(0; .001 to 100 MHz/div)	Get Frequency scan range.
SRQ=	0X000000 to 1X111111	Set the GPIB line interrupt mask. An SRQ interrupt occurs for each set error or status condition. These conditions are:

Table 5-4 (Continued) A-7550 Instruction Set

NOTE

1. Range must be entered in numeric or alphabetic (UPPERCASE or lowercase) characters.
2. See Paragraph 3-4 for details on 1-2-5 steps.

COMMAND	RANGE	DEFINITION		
		BIT/S	STATE	CONDITION
		0	1	RAM Error
		1	1	ROM Error
		2	1	Auto Cal test failure
		3	1	RF test failure
		4	1	Not used
		5	1	Acknowledge Remote
		6	1	SRQ bit
		7	1	Command error
SRQ?	(0X000000 to 1X111111)	Returns the current status of SRQ (see Bit(s), State, Condition in SRQ= Command.		
SWEPR=	5 to 2000 MS/DIV in 1-2-5 steps (see Note 2).	Set Sweep Rate.		
SWEPR?	(5 to 2000 MS/DIV in 1-2-5 steps.)	Get Sweep Rate.		
SWPC=	A or M	Disable (M) or Enable (A) Standard Sweep rate Optimization.		
SWPC?	(A or M)	Returns Sweep rate Optimization Status.		
TEST	-----	Runs all A-7550 diagnostics and returns errors through the serial poll or SRQ? Command.		
TOP?	(110 to -30)	Returns top of screen scale value. This enhances plotting the spectrum via a host computer.		
TSR=	1, 0	Set Time Share Receiver (TSR) ON (1) or OFF (0).		

Table 5-4 (Continued) A-7550 Instruction Set

NOTE

Range must be entered in numeric or alphabetic (UPPERCASE or lowercase) characters.

COMMAND *	RANGE	DEFINITION
TSR?	(1,0)	Get Status of Time Share Receiver.
VER?	(x.xx)	Returns the current version of the firmware in the A-7550.

Table 5-4 (Continued) A-7550 Instruction Set



SECTION 6 - RS-232 OPERATION

6-1 REMOTE CONTROL (RS-232) OPERATION

Remote communication with the A-7550 is provided by a half-duplex RS-232 type bus. An external controller configured to RS-232 operation is required. The A-7550 becomes a slave to the external controller.

6-1-1 PREPARATION FOR USING RS-232

A 25-pin connector is included on the rear panel, if the A-7550 is to be used for RS-232 communication to an external controller. Figure 6-1 shows the RS-232 connector used with the A-7550.

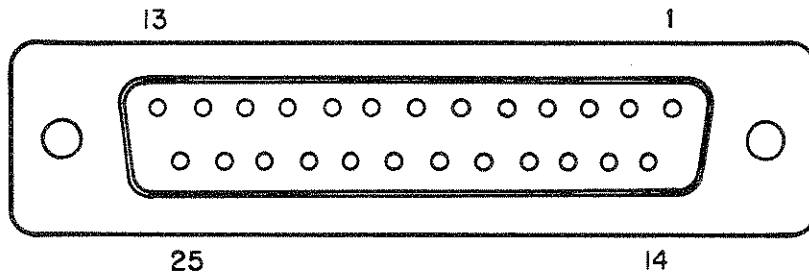

Figure 6-1 RS-232 Interface Connector

The operator must ensure proper interface between the A-7550 and the external controller. Table 6-1 shows the proper pinout for the RS-232 connector.

Pin No (Note 1)	Control Line	Direction (relative to A-7550) (Note 2)
1,7	GROUND	----
2	TRANSMIT (TX) DATA	(Output)
3	RECEIVE (RX) DATA	(Input)
4	RTS	(Output)
5	CTS	(Input)
6	DSR	(Input)
8	DCD	(Input)
20	DTR	(Output)

NOTE

1. Pin Numbers not listed are not used.
2. Refer to Communications Section of Controller Manual for proper pin number connection of Controller.
3. CTS, DSR and DCD are connected on the interface board with optional jumpers. Some controllers require CTS to be isolated from DSR and DCD. DSR and DCD must be pulled up to enable A-7550 reception.

Table 6-1 RS-232 Connector Pinout

Figure 6-2 shows the interface scheme for connecting an A-7550 Spectrum Analyzer with an IBM-PC™ (or compatible units) using the RS-232 option.

NOTE

Connections not shown are not used.

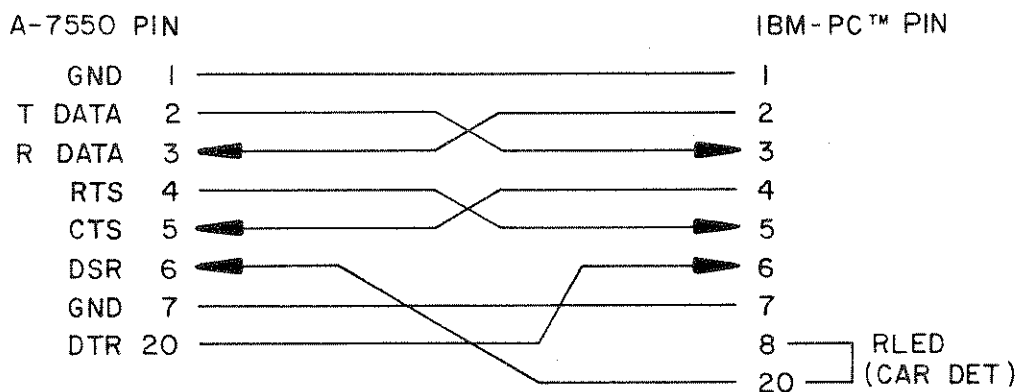

Figure 6-2 RS-232 Pinout for IBM-PC's (or compatible units)

When the proper connection is made, use the MANUAL Menu on the A-7550 to set the RS-232 communications parameters (it should have the RS-232 option installed). See Paragraph 4-9-2 for parameter descriptions.

6-2 COMMAND AND DATA STRUCTURE

All A-7550 functional commands and data information are transferred over the RS-232 as uppercase ASCII Alphanumeric Character Strings and are designed to replace the front panel controls.

6-2-1 RS-232 COMMANDS TO THE A-7550

All commands sent to the A-7550 are placed in an internal queue that can accommodate up to 128 bytes of data. Command Strings may be packed together, but the individual commands must be separated by delimiters. The delimiters are:

ASCII COLON ":" or some other assigned ASCII character

ASCII PERIOD "."

ASCII QUESTION MARK "?"

NOTE

The Question Mark ("?") is accepted at any time, but it is ignored unless it follows a command. This allows the user to continually interrogate the output buffer when waiting for a measurement. Do not use the Question Mark as a general delimiter.

The Period (".") can be used at any time, but is ignored unless used with the designated commands or as a decimal. Avoid using the period as a general delimiter.

The general delimiter is assigned using the DEL= Command. This can be any valid ASCII character with a decimal equivalent of 0 to 127 (e.g., comma (",") = 44, colon (":") = 58 and semicolon (";") = 59.

To avoid confusion or ambiguity, certain characters should not be assigned as delimiters. These include the period, question mark and all numeric and alphabetic characters.



The following ASCII Characters terminate the output command or series of commands:

Carriage Return (0D) - CR
Line Feed (0A) - LF
NULL Character (0) - NL

NOTE

The external RS-232 controller must be programmed to expect an ASCII line feed (0A) character as the termination character of the input string.

6-2-2 RS-232 COMMAND DATA FORMAT

All spaces are ignored by the controller. Following are some valid command examples:

SWEEPR = 100: SWEEPR?
SCANW?
RFATN = 10

NOTE

One of the following line terminators should be included at the end of every line to prevent execution errors from occurring:

CR, LF or NL

Maximum command string length, including spaces and delimiters, is 128 characters. If the command string exceeds this length, only those commands prior to the last delimiter and preceding the 128th character are performed. Commands past that delimiter are truncated and the Error Status bit ("S7") is then set. Commands ending with an ASCII Question Mark ("?") normally require the user to enter an ASCII String Input Command after issuing an output command.

EXAMPLE:

COMMAND: RFF?SCANW?RID=ON:RFATN?
RESPONSE: 500:100:RFATN = 10

These commands set the Reply Identifier Flag which causes the command label following "RID=ON" to be attached to the response.

6-2-3 RETURN DATA FORMAT

The returned data format convention is similar to the Output Command Data Format in that all returns are packed and separated by the assigned general delimiter(s) which must end with CARRIAGE RETURN and LINE FEED commands. The number of responses returned is determined by the number of commands transferred in one block. If the number of responses required causes the internal response buffer to overflow, because it exceeds 128 characters, then only those characters up to the last delimiter before the 128th character are returned.

Input data that is out of range generally defaults to the minimum value(s) or to the initialized value(s).

6-2-4 REPLY IDENTIFIER

When the Reply Identifier is activated by the command "RID=ON", the returned information for data or status requests are preceded by the command mnemonic and an "=" character. This continues until the command "RID=OFF" is issued or the A-7550 power is cycled. This feature is especially useful for identifying measured data returned after a time delay, or from a string of commands.

6-3. A-7550 COMMAND SET

Table 6-2 defines, in alphabetic order, the ASCII Commands used to control the A-7550 under RS-232 operation. Delimiters for each command are used throughout the Table to define different command types:

- "=" represents a "set value to" operation for that command.
- "?" represents a "get value" operation for that command.
- "." represents an "enable" operation.

Items listed under the range column reflects data entered into or retrieved from the A-7550. Data shown in parentheses is data retrieved from the unit. Data not enclosed in parentheses is data being sent to the A-7550. A series of dashes means that the command is imperative (no data required as input or output).

NOTE

All commands and data entries must be numeric, one of the assigned delimiters, or alphabetic (UPPERCASE or lowercase) characters.

COMMAND	RANGE	DEFINITION
ACAL	----	Forces one Auto Cal cycle, if Auto Cal is enabled.
ACAL=	0,1	Disables (0) or Enables (1) Auto Cal feature.
ACAL?	(0,1)	Returns A Cal status (Enabled or Disabled)
BATT?	(11.0 to 15.0 V, 0.5 V steps)	Returns Battery voltage.
BW=	.3,3,30,300,3000 kHz	Set Resolution B/W
BW?	(.3,3,30,300,3000 kHz)	Get Resolution B/W
BWC=	A or M	Disable (M) or Enable (A) B/W optimization.
BWC?	(A or M)	Returns B/W optimization status.
DEL=	0 to 127, inclusive.	Sets the delimiter to the ASCII character represented by the assigned decimal number.
DEL?	(0 to 127)	Returns the decimal number for the ASCII delimiter character.
DISP=	LINE,BAR,REF	Sets display to one of three modes.
DISP?	(LINE,BAR,REF)	Returns display mode of A-7550.
GEN=	1,0	Set the generator on (1) or off (0).
GEN?	(1,0)	Return status of Gen Switch.
GENLVL=	0 to 70	Set generator output level. Depends upon "REF=" and "IMP=" command settings.

Table 6-2 A-7550 Instruction Set

NOTE

Range must be entered in numeric or alphabetic (UPPERCASE and lowercase) characters.

COMMAND	RANGE	DEFINITION
GENLVL?	(0 to 70)	Return generator output level setting.
GET(xx)?	(0-511)	Returns 10 points out of the 390 stored points from the last stored display beginning with data group xx (1-39). The returned points are separated by the delimiter assigned in the DEL= command (see Note 2).
IFGAIN=	0 to 65, step 1 dB	Set the IF GAIN to the designated value.
IFGAIN?	(0 to 65)	Get the IF GAIN value.
IMPD=	50,75	Set the impedance (in ohms).
IMPD?	(50,75)	Get the impedance value.
MIN? MIN(from)? MIN(from:to)?	(0-511:1-390)	Returns the minimum value of the last stored display for the specified horizontal range. The value is returned in the format: (yyy:xxx); where yyy is the minimum level (0 to 511) corresponding to the requested horizontal value(s) (1 to 390). The range returned can be in the following formats:

Table 6-2 (Continued) A-7550 Instruction Set

NOTE

1. Range must be entered in numeric or alphabetic (UPPERCASE or lowercase) characters.
2. When receiving display data points, values not displayed can be returned. When receiving a STORED REF trace, values can be negative or greater than 511, as this is a computed RATIO (i.e., (stored signal)/(input signal)).

COMMAND	RANGE	DEFINITION
MIN? (cont.)		<p>MIN? - The entire stored display is scanned for the minimum signal level.</p> <p>MIN(from)? - The stored display is scanned <u>from</u> the specified horizontal value to the end of the display.</p> <p>MIN(from:to) - The stored display is scanned <u>from</u> the first specified point <u>to</u> the second specified point.</p> <p style="text-align: center;">NOTE</p> <p>a. These points must be specified in proper sequence (that is, minimum value must be less than or equal to maximum value).</p> <p>b. The delimiter separating "from:to" and returned requests is assigned with the DEL= command.</p> <p>c. If no value precedes the delimiter, 1 is assumed to be the first assigned point.</p>
MODE=	AVE,COMP,STORE,RECALL,LIVE,PKHOLD	Sets A-7550 to selected mode.
MODE?	(AVE,COMP,STORE,RECALL,LIVE,PKHOLD)	Returns A-7550 mode.

Table 6-2 (Continued) A-7550 Instruction Set

NOTE

Range must be entered in numeric or alphabetic (UPPERCASE or lowercase) characters.

COMMAND	RANGE	DEFINITION
PEAK? PEAK(from)? PEAK(from:to)?	(0-511:1-390)	<p>Returns the peak value of the last stored display for the specified horizontal range. The value is returned in the format: (yyy:xxx); where yyy is the maximum level (0 to 511) corresponding to the requested horizontal value(s) (1 to 390). The range returned can be in the following formats:</p> <p>PEAK? - The entire stored display is scanned for the maximum signal level.</p> <p>PEAK(from)? - The stored display is scanned <u>from</u> the specified horizontal value to the end of the display.</p> <p>PEAK(from:to) - The stored display is scanned <u>from</u> the first specified point <u>to</u> the second specified point.</p> <p style="text-align: center;">NOTE</p> <p>a. These points must be specified in proper sequence (that is, minimum value must be less than or equal to maximum value).</p>

Table 6-2 (Continued) A-7550 Instruction Set

NOTE

Range must be entered in numeric or alphabetic (UPPERCASE or lowercase) characters.

COMMAND	RANGE	DEFINITION
		<p>b. The delimiter separating "from:to" and returned requests is assigned with the DEL= command.</p> <p>c. If no value precedes the delimiter, 1 is assumed to be the assigned point.</p>
PEAKF=	NONE,30K,300	Set peak filter value.
PEAKF?	(NONE,30K,300)	Get peak filter value.
PUT(xx)=	0-511	Sends 10 points to the A-7550 to be stored for display beginning with data group xx (1-39). The data must be valid numbers separated by the delimiter assigned with the DEL= command. To display the transferred information, the A-7550 must be in the "recall" mode.
QUASI=	TC1,TC2,TC3	Set Quasi-Peak filter value.
QUASI?	(TC1,TC2,TC3)	Return Quasi-Peak filter value.
RCVR=	FM1,FM2,SSB,AM1,AM2	Sets 10.7 MHz Receiver Modulation.
RCVR?	(FM1,FM2,SSB,AM1,AM2)	Returns 10.7 MHz Receiver Modulation.
REF=	DBM, DBUW, DBV, DBMV, or DBUV	Set scale reference label.
REF?	(DBM, DBUW, DBV, DBMV, or DBUV)	Return scale reference label.
RFATN=	0 to 60, step 10 dB	Set RF Input Attenuator level.

Table 6-2 (Continued) A-7550 Instruction Set

NOTE

Range must be entered in numeric or alphabetic (UPPERCASE or lowercase) characters.

COMMAND	RANGE	DEFINITION
RFATN?	(0 to 60, step 10 dB)	Get RF Input Attenuation level.
RFF=	000.0050 to 999.9999	Set Analyzer Frequency.
RFF?	(000.0050 to 999.9999)	Returns Analyzer Frequency.
RID=	ON/OFF	Controls the Reply Identifier Switch. When ON, adds the command name followed by "=" as a prefix to a command's response.
RID?	(ON/OFF)	Returns the current reply identifier status.
SCALE=	2, 10, LIN	Set Amplitude Scale
SCALE?	(2,10,LIN)	Get Amplitude Scale
SCANW=	0; .001 to 100 MHz/div in 1-2-5 sequence (see Note 2).	Set Frequency scan range.
SCANW?	(0; .001 to 100 MHz/div)	Get Frequency scan range.
SRQ=	0X000000 to 1X111111	Set the GPIB line interrupt mask. An SRQ interrupt occurs for each set error or status condition. These conditions are:

Table 6-2 (Continued) A-7550 Instruction Set

NOTE

1. Range must be entered in numeric or alphabetic (UPPERCASE or lowercase) characters.
2. See Paragraph 3-4 for details on 1-2-5 steps.

COMMAND	RANGE	DEFINITION		
		BIT/S	STATE	CONDITION
		0	1	RAM Error
		1	1	ROM Error
		2	1	Auto Cal test failure
		3	1	RF test failure
		4	1	Not used
		5	1	ACK request
		6	1	Not used
		7	1	Command error
SRQ?	(0X000000 to 1X111111)	Returns the current status of SRQ (see Bit(s), State, Condition in SRQ= Command.		
SWEPR=	5 to 2000 MS/DIV in 1-2-5 steps (see Note 2).	Set Sweep Rate.		
SWEPR?	(5 to 2000 MS/DIV in 1-2-5 steps.)	Get Sweep Rate.		
SWPC=	A or M	Disable (M) or Enable (A) Standard Sweep rate Optimization.		
SWPC?	(A or M)	Returns Sweep rate Optimization Status.		
TEST	-----	Runs all A-7550 diagnostics and returns errors through the serial poll or SRQ? Command.		
TOP?	(110 to -30)	Returns top of screen scale value. This enhances plotting the spectrum via a host computer.		
TSR=	1,0	Set Time Share Receiver (TSR) ON (1) or OFF (0).		

Table 6-2 (Continued) A-7550 Instruction Set

NOTE

Range must be entered in numeric or alphabetic (UPPERCASE or lowercase) characters.

COMMAND	RANGE	DEFINITION
TSR?	(1,0)	Get Status of Time Share Receiver.
VER?	(x.xx)	Returns the current version of the firmware in the A-7550.

Table 6-2 (Continued) A-7550 Instruction Set

SECTION 7 - QUASI-PEAK OPERATION

7-1 QUASI-PEAK PURPOSE

International agreement and Federal regulations state the need to monitor Electromagnetic Interference (EMI) produced from electronic sources. The guidelines, originally set by Comite International Special des Perturbations Radioelectroniques (CISPR), were adapted by the American National Standards Institute (ANSI) and are regulated by the Federal Communications Commission (FCC). Refer to ANSI Standard C63.2-1980 and FCC Rules and Regulations, Volume II, Part 15, Subpart J for further information.

Quasi-Peak measurements offer a larger dynamic range for measurement of pulsed frequencies than do most common methods of frequency measurement devices (e.g., RMS and peak). The A-7550 Quasi-Peak option is a compact and efficient EMI measurement tool.

7-2 QUASI-PEAK PREREQUISITES

7-2-1 UNITS

The preferred unit for Quasi-Peak measurement is dB μ V; which results in positive voltage readings. Use menu option 2 of the SETUP Menu (see Paragraph 4-8) to select the dB μ V parameter.

7-2-2 LINEAR MODE

Quasi-Peak measurements are valid in LINEAR Mode only. Time constants cannot be amplified and weighted using a logarithmic scale. Appendix D supplies values for calculating the signal amplitude when reading the A-7550 linear scale. The signal amplitude is calculated using the formula:

$$A = T + (20 \text{ Log } (D \div 8))$$

T is the Top of Scale value and D is the number of divisions from the bottom graticule on the screen (see Figure 7-1).

NOTE

Appendix D applies to all readings using the Linear Scale. Quasi-Peak is only one application of this scale.

The top 87.5% of the Linear Scale spans an 18 dB range. For more accurate readings, adjust amplitude readings to the upper-middle segment of the screen.

NOTE

When adjusting IF GAIN, avoid introducing compression into the signal measurement.

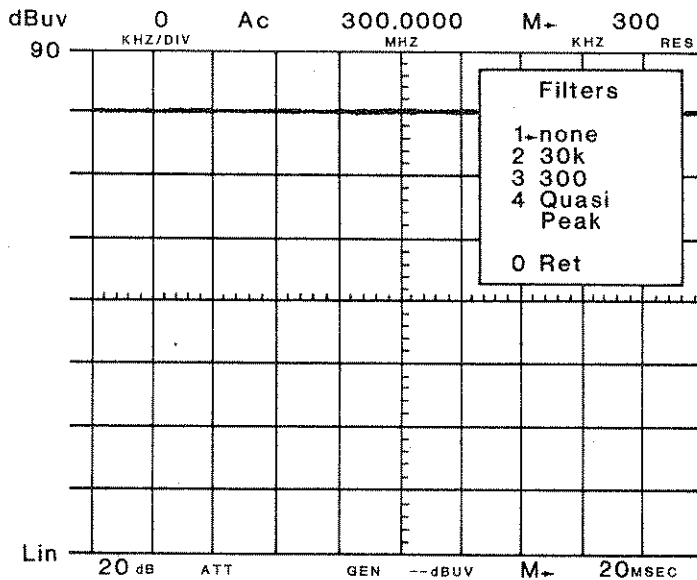

Figure 7-1 Linear Scale

7-2-3 SCAN WIDTH SELECTION

For most Quasi-Peak measurements, set the Scan Width to zero.

If the Scan Width selected for Quasi-Peak is not zero, then set the Sweep Rate to a slow enough setting so the charge and discharge times do not interfere with measurements. It is suggested that the operator force one Auto Cal cycle (see Paragraph 4-10) before starting EMI measurements. In Quasi-Peak Mode, Bandwidth and Sweep Rate optimization does not occur.

7-2-4 CONTINUOUS WAVE SIGNALS

The peak level of a CW signal equals the Quasi-Peak level. The amplitude of a Quasi-Peak measurement must be less than or equal to the level at a peak measurement.

Figures 7-2 through 7-4 illustrate the amplitude error for each Time Constant at sweep times and frequency spans available on the A-7550. The graphs show empirical data. Table 7-1 suggests the optimum sweep rates for TC2 and TC3 operation. It is not possible to scan in TC1 without appreciable amplitude error.

TC2		TC3	
SCANWIDTH (kHz/Div)	SWEEP RATE (Sec/Div)	SCANWIDTH (kHz/Div)	SWEEP RATE (Sec/Div)
1	.1	1	.1
2	.2	2	.1
5	.5	5	.1
10	1	10	.1
20	2	20	.2
--	-	50	1
--	-	100	1

Table 7-1 Optimum Sweep Rates for TC2 and TC3

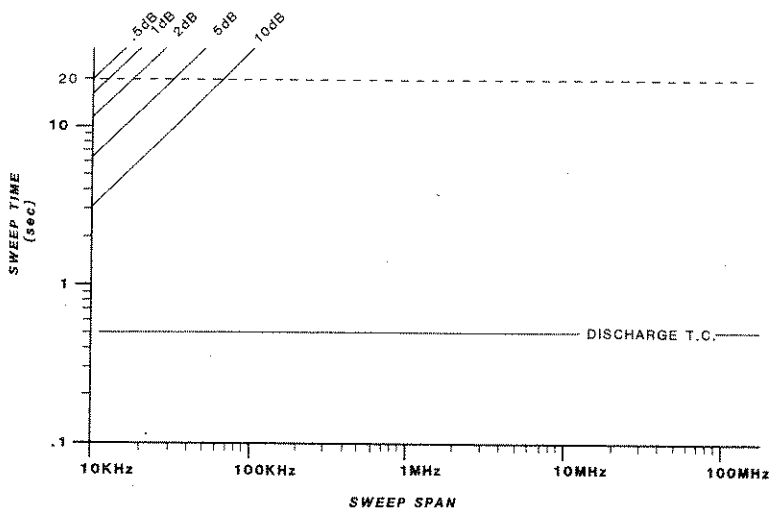

Figure 7-2 TC1 Amplitude Error (Frequency Range: 10 to 150 kHz)

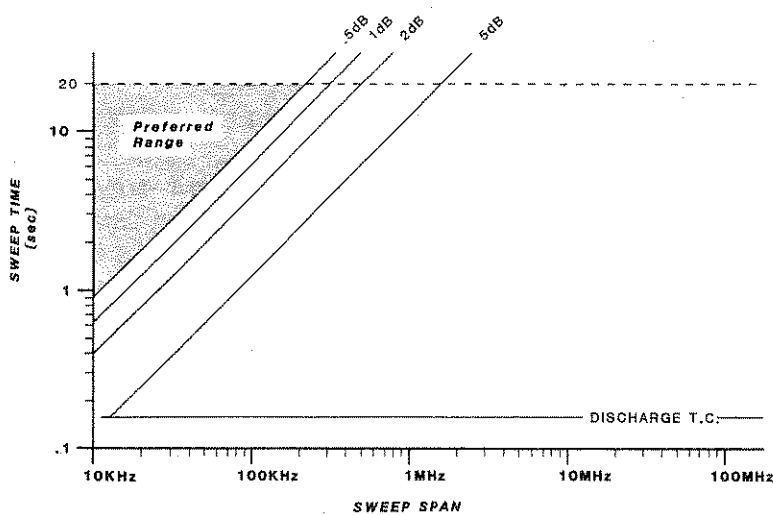

Figure 7-3 TC2 Amplitude Error (Frequency Range: 150 kHz to 30 MHz)

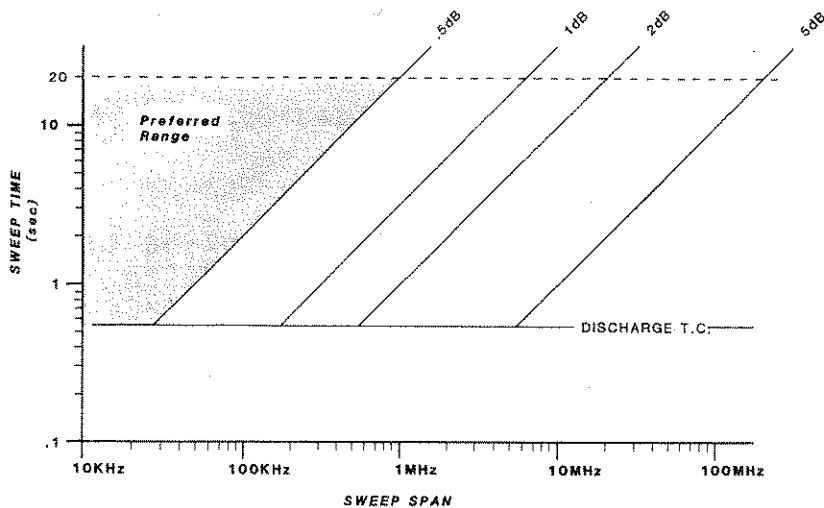

Figure 7-4 TC3 Amplitude Error (Frequency Range: 30 MHz to 1 GHz)

7-2-5 TIME CONSTANTS

EMI measurements are performed within the constraints stated in Table 7-2. The Charge Time Constant is the time required, after instantaneous application of a constant RF sine-wave (CW) voltage at the Analyzer Input, for the output voltage to reach 63 percent of its final value. The Discharge Time Constant is the time required, after instantaneous removal of a constant sine-wave (CW) voltage applied to the input of the measuring set, for the output voltage to fall to 37 percent of its initial value.

Time Constant	Charge Time (mSec)	Discharge Time (mSec)	Bandwidth (Hz)	Frequency Range
TC1	45	500	200	10 to 150 kHz
TC2	1	160	9k	150 kHz to 30 MHz
TC3	1	550	120k	30 MHz to 1 GHz

Table 7-2 Quasi-Peak Time Constants

7-2-6 LINE IMPEDANCE STABILIZATION NETWORKS (LISN)

An LISN isolates power line EMI from the UUT and measuring device, and prevents EMI from the UUT from entering the power source. This provides isolation when making conducted EMI measurements (see Figure 7-5).

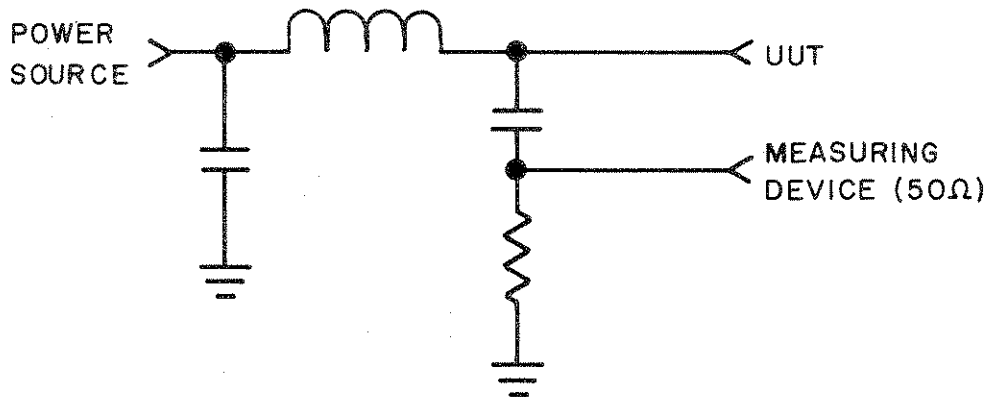

Figure 7-5 Line Impedance Stabilization Network

CAUTION

DAMAGE TO THE A-7550 IS POSSIBLE DURING CONDUCTED EMISSION MEASUREMENTS WHEN SWITCHING LISN LINES CONNECTED TO THE A-7550. CHECK THE UNIT SPECIFICATIONS BEFORE CONNECTING IT TO THE A-7550 INPUT.

7-2-7 ANTENNA FACTOR

The antenna factor is supplied by the manufacturer of the equipment. This is a conversion factor required to convert the indicated voltage value of the A-7550 to the actual antenna voltage.

7-3 QUASI-PEAK MEASUREMENT PROCEDURE

The following procedure is an example of one way to isolate signals and take Quasi-Peak readings. The advantages of this procedure include:

- a. Observing the entire A-7550 frequency range at one time;
- b. Eliminating ambient signals before introducing signals from the UTT;
- c. Eliminating the need to perform Quasi-Peak testing at all frequencies.

NOTE

While the following procedure for measuring Quasi-Peak is optional, the following guidelines are not:

- Always set the Amplitude Scale to LINEAR before making Quasi-Peak measurements.
- Set SCANWIDTH TO 0 kHz/DIV (except as noted in Paragraphs 7-2-3 and 7-2-4).
- Use the dB μ V Reference Scale (optional).

Also, to "zero in" at the signal in question, use the IF GAIN and RF ATTEN keys. Be cautious, however, to avoid introducing signal compression when adjusting IF GAIN.

1. Turn on the A-7550 with the UUT turned off. Set it to a Center Frequency of 500 MHz and a Scan Width of 100 MHz/Div (Press "RF" "ENTER"). See Figure 7-6. This allows you to observe the full spectrum of signals.

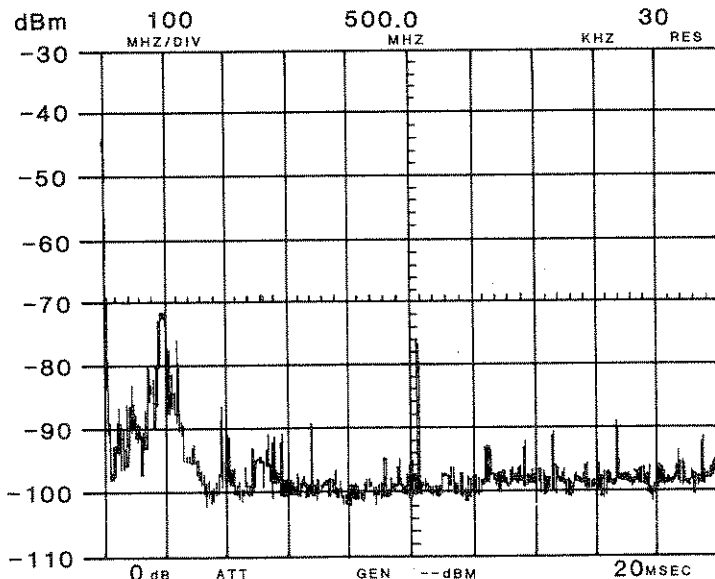

Figure 7-6 Initial Background or Ambient Signals

2. Enter MODE Menu (Press: "MENU" "2") and select LIVE (Press: "5"). Store the trace (Press: "3"). Exit MODE Menu (Press: "0").
3. Enter the Display Menu (Press: "1") and select the REF display (Press: "3"). See Figure 7-7.

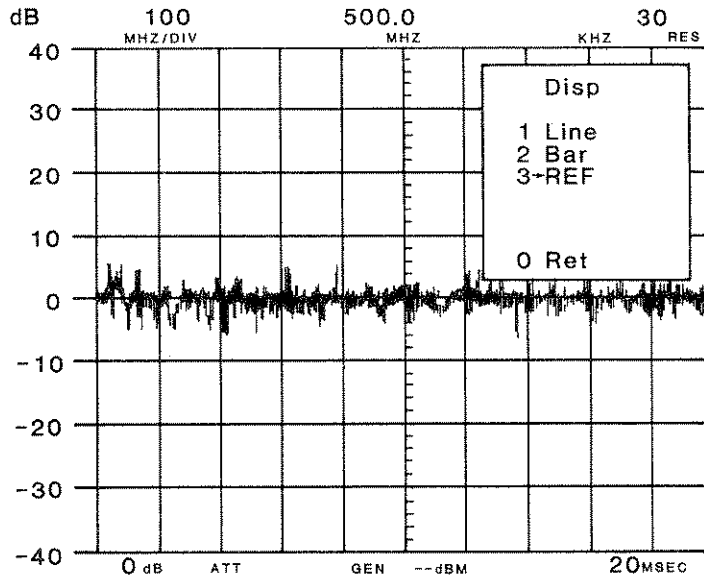

Figure 7-7 Reference Display (with Ambient Signals Zeroed)

4. Turn on the unit to be tested for EMI. Watch for signals which appear when UUT is turned on. Note, in Figure 7-8, the signal at 100 MHz, 225 MHz and 330 MHz as a comparison to the signal in Figure 7-7. These signals are from UUT.

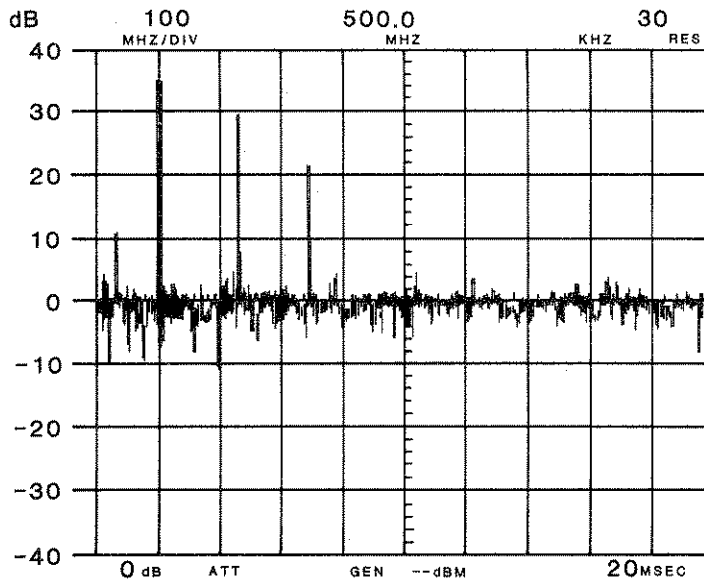

Figure 7-8 Reference Display with UUT Turned On

5. As an example, to look closer at the signal at 100 MHz, press the following key sequence:

"MENU" "2" (display mode) "1" (line display) "RF"
"100." "ENTER"

NOTE

Bandpass the frequency range in question, if signals in other bands are high.

6. Use the IF GAIN and/or the RF ATTEN keys to position the signal with its peak close to, but not above, the top graticule (see Figure 7-9).

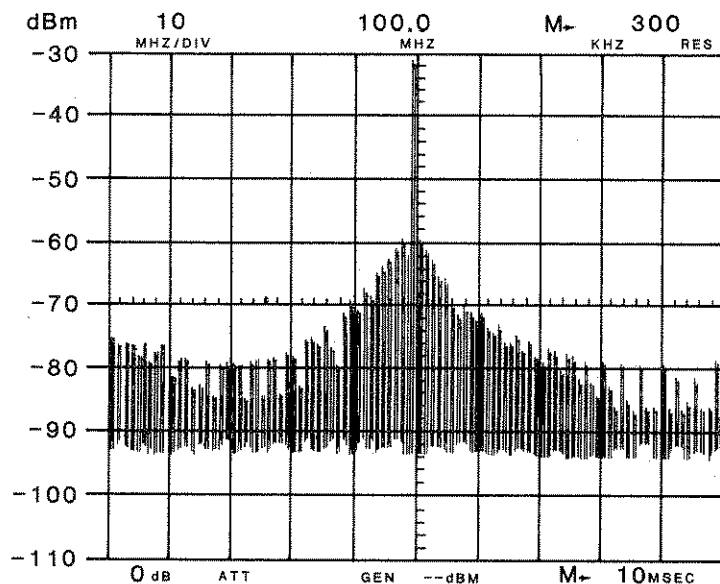

Figure 7-9 Signal of Interest at 100 MHz (TC3)

7. Change the Reference Scale to Linear Mode (Press: "2dB/10dB/LIN") and change the reference units to dB μ V. (Press: "MENU" "5" (Setup) "2" "2"). If the signal is within regulation at this point (i.e., at peak reading), then UUT passes and no further measurements are required.

NOTE

The maximum EMI level for any electronic device is established by the FCC in Rules and Regulations, Volume II, Part 15, Subpart J.

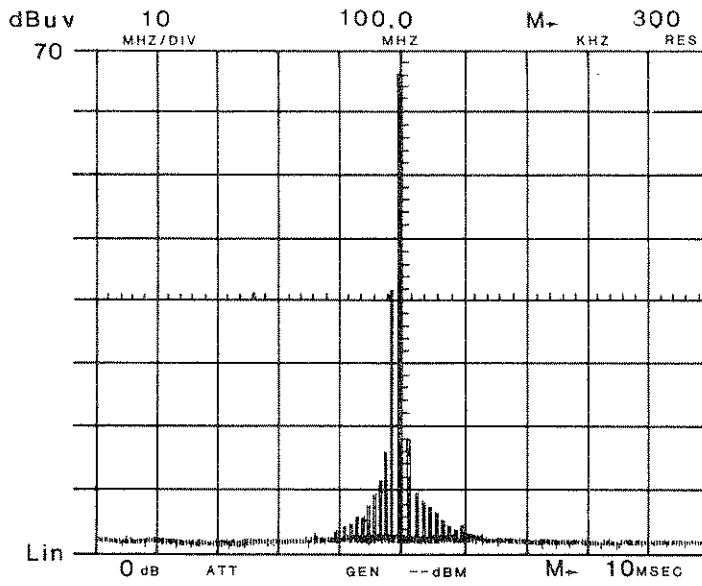

Figure 7-10 UUT Readout in Linear Mode

8. Use the SCAN WIDTH DOWN "↓" key to set the Scan Width to zero. Return to the Master Menu and select the FILTERS Menu (Press: "0" "4"). See Figure 7-11.

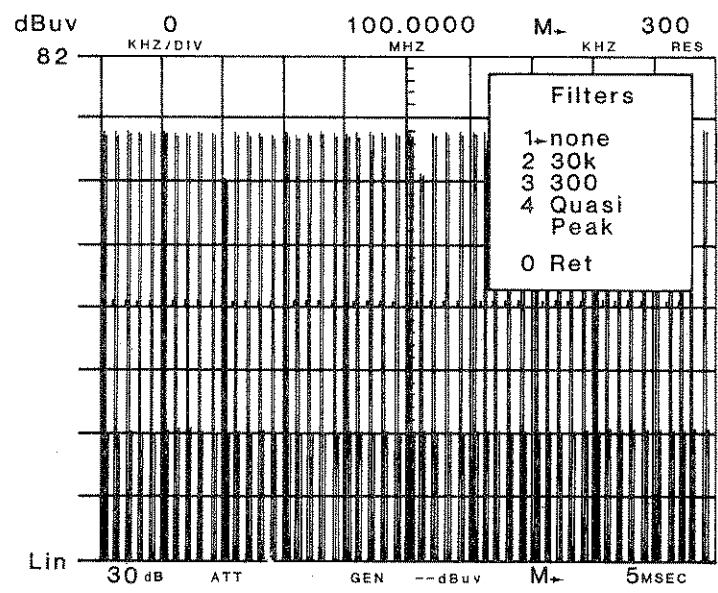

Figure 7-11 Frequency in Question Before Quasi-Peak

9. Select the Quasi-Peak Filter Menu (Press: "4"). Refer to Figure 7-12 and to Appendix D to compute the Signal Amplitude at the Frequency in question.

NOTE

Be sure you have selected the correct Time Constant for the frequency in question.

In Figure 7-12, the Signal Amplitude level is approximately 4.85 divisions above the bottom graticule on the display. The X value, from Table D-1, is -4.35. The Top of Scale is 82 dBuV. Using the equation for Signal Amplitude ($A = T + X$), the calculated Signal Amplitude is 77.65 dBuV.

The actual Signal Amplitude is figured by computing the calculated Signal Amplitude with the Antenna Factor supplied by the manufacturer of the antenna. The adjusted Signal Amplitude value is then compared to the limit set by the FCC for EMI emissions for the UUT.

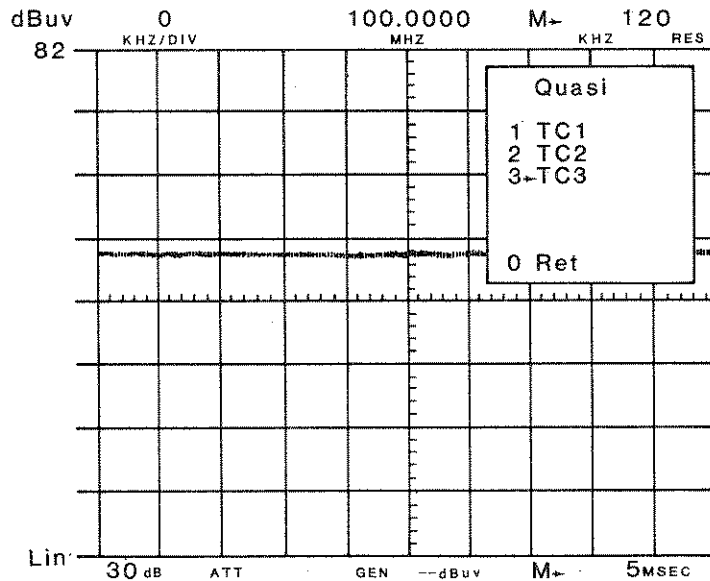

Figure 7-12 Frequency in Question With Quasi-Peak Activated



APPENDICES

APPENDIX A - A-7550 PERFORMANCE SPECIFICATIONS

A-1 FREQUENCY

Frequency Range:	100 kHz to 1 GHz in 100 Hz steps.
Frequency Display Span:	1 kHz/DIV to 100 MHz/DIV in 1-2-5 sequence. In "0" the analyzer is a fixed-tuned receiver.
Frequency Display Linearity:	Frequency error between any two points on the display is less than $\pm 5\%$ of the indicated frequency separation.
Digital Frequency Readout:	Indicates center frequency at the frequency display span.
Accuracy:	$\pm 3\%$ of frequency display span plus 0.0025% of frequency selected.
Resolution:	
Bandwidth Ranges: (at 3 dB)	300 Hz, 3 kHz, 30 kHz, 300 kHz and 3 MHz.
Accuracy:	$\pm 30\%$ of bandwidth selected.
Filter Shape Factor:	60 dB/3 dB ratio $< 5:1$, 300 Hz $< 12:1$.
Video Filter:	Post-detection filter used to average displayed noise. 30 kHz and 300 Hz bandwidths selectable.
Residual FM (typical):	< 30 Hz RMS peak at scan/DIV settings below 200 kHz/DIV.
Noise Sidebands (typical):	> 65 dB below peak cw signal at 5X resolution bandwidth setting from cw signal. (With 300 Hz video filter).

A-2 AMPLITUDE

Measurement Range:	-120 dBm to +30 dBm.
--------------------	----------------------

Spurious: For input signals >3 MHz and <30 dBm:
 - from 10 kHz to 100 kHz @ -75 dBm (max)
 - from 100 kHz to 1 MHz @ -85 dBm (max)
 - from 1 MHz to 2 MHz @ -115 dBm (max)

Displayed Dynamic Range: 70 dB in 10 dB/DIV log scale. 16 dB in 2 dB/DIV log scale. 8 divisions with linear amplitude scale.

Amplitude Scale Linearity: 10 dB/DIV log ± 0.15 dB/dB, but not more than ± 2.5 dB over 70 dB dynamic range.
2 dB/DIV log ± 0.4 dB/2 dB, but not more than ± 1.5 dB over 14 dB dynamic range.
Linear demodulation linearity $\pm 2\%$ of full scale.

Frequency Response: ± 2 dB over 10 MHz to 1000 MHz range from the center of amplitude excursions.

Amplitude Variation between Bandwidth: ± 1 dB; except ± 2 dB for 300 Hz.

A-3 INPUT

Impedance: 50 Ω nominal, 75 Ω optional.

Attenuator: 60 dB range in 10 dB steps.
 Accuracy: ± 0.5 dB/10 dB steps.

Maximum Input Levels: 4 volts DC or +30 dBm with maximum input attenuation. +20 dBm for all other conditions.

A-4 OUTPUT

Calibrator:

Frequency: 100 MHz \pm .0025%, crystal controlled.
Amplitude: -30 dBm \pm 1 dB.
Sweep Out: 0 to 5V ramp (nominal).
Video Out: 0 to 800 mV riding on DC level.

A-5 GENERAL CHARACTERISTICS

Dimensions: 33.3 cm (13.1") wide, 18.5 cm (7.3") high, 49.8 cm (19.6") deep.
Weight (approximate): 12.6 kg (28 lbs.) without options.
Temperature Range: 0° to 50° C.
Power Requirements:
Line: 106 to 266 VAC, 50 to 400 Hz at 55 watts typical (no options).
External D.C.: 12 to 30 VDC nominal.
4 Amps at 12V typical (no options).
2 Amps at 28V typical (no options).

A-6 TRACKING GENERATOR (OPTIONAL)

Frequency Range: 100 kHz to 1 GHz
Output Level: 0 dBm to -75 dBm in 1 dB steps.
Flatness: \pm 2 dB
Residual FM: <100 Hz RMS peak
Output Impedance: 50 Ω nominal (75 Ω optional)
Spurious: Harmonics: 20 dBc or lower.
Non-harmonics: 40 dBc or lower.

A-7 +20 dB AMP (OPTIONAL)

Range: 100 kHz to 1 GHz

Center Frequency Resolution: 100 Hz

Sensitivity: 2 μ V typical

Selectivity: (at 3 dB)

Mode	Receiver Bandwidth
FM 2	200 kHz
FM 1	15 kHz
SSB	6 kHz
AM 1	6 kHz
AM 2	15 kHz

Adjacent Channel Rejection: (at 3 dB)

Receiver Bandwidth	40 dB DOWN AT
200 kHz	\pm 300 kHz
15 kHz	\pm 27 kHz
6 kHz	\pm 12 kHz

A-8 RECEIVER (OPTIONAL)

Frequency Range	Bandwidth at 6 dB	Charge Constant	Time (ms)	Discharge Constant	Time (ms)
<150 kHz	200 Hz	TC1	45 mS	TC1	500
150 kHz to 30 MHz	9 kHz	TC2	1 mS	TC2	160
>30 MHz	120 kHz	TC3	1 mS	TC3	550

A-9 QUASI-PEAK DETECTOR (OPTIONAL)

Frequency Range: 10 MHz to 1 GHz

Gain: +20 dB (nominal)

APPENDIX B - BASIC OPERATING PROCEDURES

B-1 GENERAL

This appendix contains a unit testing procedure to familiarize the user with the control panel operation of the A-7550 Spectrum Analyzer. The test procedure is divided into separate procedures, none of which requires internal access to the unit. These procedures cover the standard A-7550 Analyzer, Tracking Generator option, 10.7 MHz FM/AM Receiver option and the 75 Ω option.

General operating procedures are included in this manual for GPIB (Section 5), RS-232 (Section 6) and Quasi-Peak Filter (Section 7) operation. Refer to the appropriate section of this manual if any of these options are installed in your unit.

OPERATING NOTES:

ANNUNCIATOR

Beeps only if key entry is valid and is accepted by microprocessor. Volume is adjusted by ANNUNCIATOR Volume Adjust pot. (VOLUME Control is for demod audio and is only applicable if 10.7 MHz Receiver option is installed.)

NUMBER KEYS

Number key functions differ for RF and MENU keys. ENTER key must be pressed to allow microprocessor to accept new RF.

FULL SCAN MODE





Set by pressing "RF,ENTER". This sets the Center Frequency to 500 MHz and the SCAN WIDTH to 100 MHz/Div.





GRATICULE LABELS

















The microprocessor changes the graticule labels based on RF attenuation, IF Gain, 50 Ω or 75 Ω operation, graticule scale selection (dBm, dBmV, dB μ V, dBV, dB μ W). IN ALL CASES, THE LEVEL OF AN INPUT SIGNAL IS THE ACTUAL LEVEL DISPLAYED ON THE CRT.

B-2 A-7550 OPERATING PROCEDURES

B-2-1 PROCEDURE FOR STANDARD A-7550 UNIT







STEP	ACTION	RESULT/NOTE
1.	Connect AC Power Cord to AC Power Connector (17) and Plug into electrical outlet.	Outlet must meet requirements stated in Paragraph A-5.
2.	Set PWR/OFF/BATT Switch (2) to "PWR".	Power On Indicator (3) should light up and the IFR logo should appear on the CRT display (11).
3.	Wait approximately ten seconds or press any key.	The IFR logo should disappear, replaced by the graticule display.
4.	If necessary, adjust TRACE Intensity Control (14) and GRATICULE Intensity (13).	Sets CRT display to desired contrast. Use a small non-magnetic screwdriver or a tuning tool for the GRATICULE Intensity Adjust.
5.	Press: 	Verifies Master Menu appears on CRT display.
6.	Press: 	Verifies SETUP Menu appears on the the CRT display.
7.	Press: 	Verifies TEST Menu appears on CRT display and all tests Pass (i.e., "P" is indicated in menu window following each test).
NOTE		
Individual tests can be run by pressing the numeric key equivalent of the test in the menu window.		
8.	Press: 	Returns to SETUP Menu.

STEP	ACTION	RESULT/NOTE
9. Press:		<p>Alternates graticule display between 50Ω and 75Ω settings. Select 50Ω.</p>
NOTE		
<p>Selecting 75Ω impedance only changes the setting and graticule scales. If operating at 75Ω, a 75Ω adapter must be connected to the ANALYZER INPUT Connector (10).</p>		
10. Press:		<p>Verifies MANUAL Menu appears on CRT display.</p>
11. Press:		<p>Alternates between Bandwidth Optimization and Manual Bandwidth selection. When optimization is active, "Bw = A" is displayed in the menu window. When optimization is inactive, "Bw = M" is displayed in the menu window and the Manual Bandwidth Indicator (M+) appears on the CRT Display. Set menu to indicate Bandwidth Optimization is active (Bw = A). The Manual Indicator should disappear.</p>
12. Press:		<p>Alternates between Sweep Rate Optimization and Manual Sweep Rate selection. When optimization is active, "Swp = A" is displayed in the menu window. When optimization is inactive, "Swp = M" is displayed in the menu window and the Manual Bandwidth Indicator (M+) appears on the CRT Display. Set menu to indicate Sweep Rate Optimization is active (Swp = A). The Manual Indicator should disappear.</p>

STEP	ACTION	RESULT/NOTE
13.	Press: 	Alternates between Auto Calibration (Auto Cal) active or inactive. When Auto Cal is active, "Acal = 1" is displayed in the menu window. When Auto Cal is inactive, "Acal = 0" is displayed in the menu window and the Auto Cal Indicator (Ac) appears in the CRT Display. Set menu to indicate Auto Cal is active (Acal = 1). The Auto Cal Indicator should disappear.
14.	Press:  	Menu should disappear and reappear with Master Menu in menu window.
15.	Press: 	Verifies DISPLAY Menu appears.
16.	Press: 	Selects LINE mode of operation.
17.	Press: 	Returns to Master Menu.
18.	Press: 	Selects MODE Menu.
19.	Press: 	Selects LIVE mode of operation.
20.	Press: 	Returns to Master Menu.
21.	Press: 	Selects FILTERS Menu.
22.	Press:  	Selects NO FILTER option, then clears the Menu display.
23.	Press the following key sequences as needed: (a)     	Sets Center Frequency to 100.00 MHz.

NOTE

Only significant digits appear in the Center Frequency display. Significant digits are determined, in part, by Scan Width.

STEP	ACTION	RESULT/NOTE
23. (Continued)		
(b)	 or 	Sets RF ATTEN to 10 dB. Press RF ATTEN key (up or down) until the desired Attenuation appears in the "ATT" display block on the CRT display.
(c)	 or 	Sets Scan Width to 1 MHz/DIV. Press one of the Scan Width keys until 1 MHz/DIV appears in the Scan Width display block on the CRT display.
d)		Sets Graticule Scale to 2 dB, Linear or 10 dB divisions. Press the 2dB/LIN/10dB key until the graticules at each major division are 10 dB apart.
e)		Steps down IF GAIN. Continue to step down the IF GAIN until top graticule reads -20 dBm.

24. Connect 50Ω BNC-to-BNC Coax Cable from CAL OUT (9) to ANALYZER INPUT (10).

CRT display should be similar to Figure B-1.

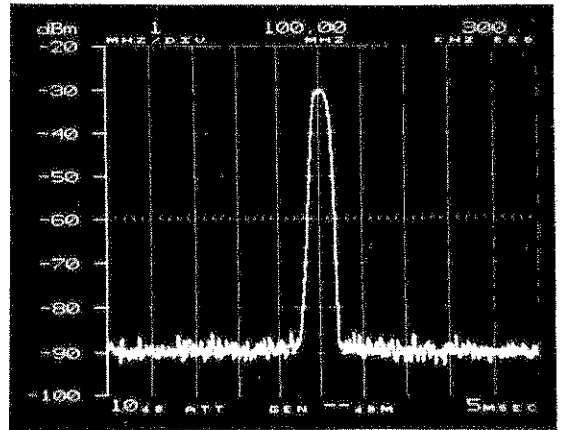





















Figure B-1 CAL OUT Signal Display

25. Press:



Steps up IF GAIN in 1 dB steps. Continue to step up IF GAIN 10 dB and watch the entire signal display, including the noise floor, move up with each step.

STEP	ACTION	RESULT/NOTE
26.	Press: 	Steps down IF GAIN in 1 dB steps. Continue to step down IF GAIN 10 dB and watch the entire signal display, including the noise floor, drop with each step.
27.	Press: 	Steps up the RF Attenuation 10 dB. The noise floor does not change, but the graticule display changes.
28.	Press:  	Selects Full Scan. The Center Frequency setting is 500.0 MHz.
29.	Press:          	Resets the Center Frequency to 100 MHz.
		NOTE Non-significant digits entered are not displayed. The frequency does not change until ENTER is pressed.
30.	Press: 	The CRT display changes as the SCAN WIDTH decreases. The shape of the signal changes relative to the Resolution Bandwidth vs. the Scan Width (see Appendix E). Scan Width should step down to 0 kHz/DIV.
31.	Press: 	Resets Scan Width to 10 kHz/DIV.
32.	Press:  	Re-enters Menu mode and selects MODE Menu.
33.	Press: 	Selects AVERAGE mode of operation. The noise level in the display should be reduced.

STEP	ACTION	RESULT/NOTE
34.	Press: 	Returns to LIVE operation mode.

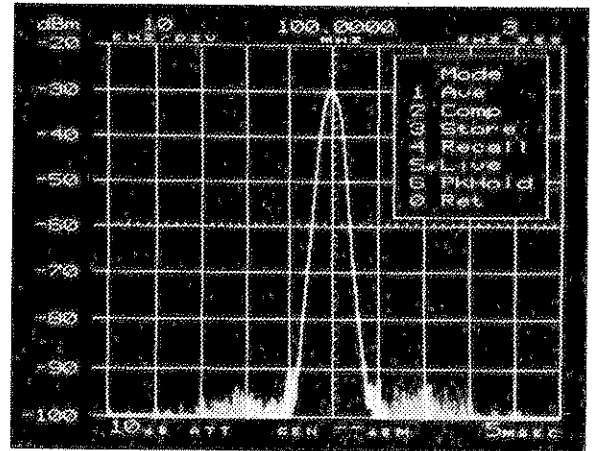



Figure B-2 Live Trace to be Stored

35.	Press: 	Stores the display in memory.
-----	--	-------------------------------

NOTE

When "3" is pressed, the arrow in the menu momentarily points to "3" and returns to the previous mode of operation.

36.	Press: 	Selects RECALL mode to observe the stored display. Display should be similar to Figure B-2.
-----	--	---

NOTE

The parameters from the STORED trace are displayed ONLY in RECALL mode.

37.	Press: 	Returns to LIVE operation mode.
-----	--	---------------------------------

STEP

ACTION

RESULT/NOTE

38. Press:



Adds 20 dB RF Attenuation to signal. This increases the level of RF ATTEN to 30 dB and drops the signal amplitude on the CRT display 2 major divisions (compare Figure B-2 to Figure B-3).

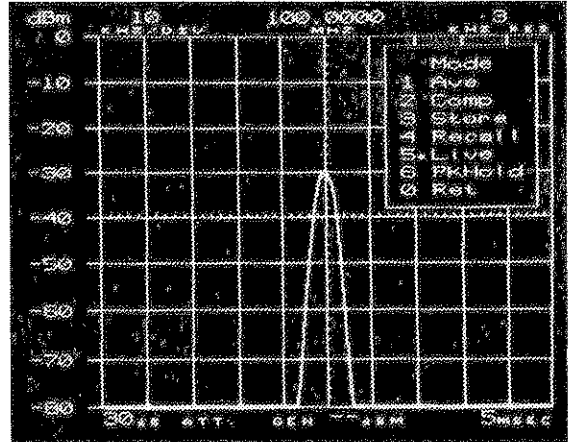

Figure B-3 Signal with 30 dB RF ATTEN

39. Press:



Selects COMPARE operation mode. The shaded area on the CRT display represents the difference between the stored (Figure B-2) signal and the LIVE (Figure B-3) signal (i.e., 20 dB amplitude difference with same RF).

NOTE

In compare mode, only the current parameters (LIVE) are displayed on the CRT display.

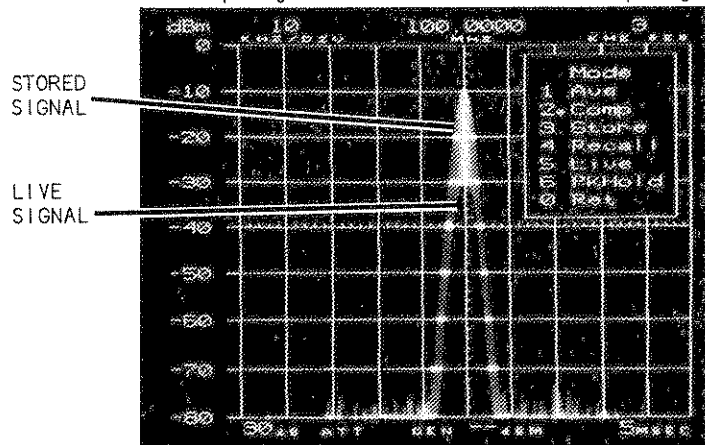





Figure B-4 COMPARE Mode Display: STORED vs. LIVE TRACE

STEP	ACTION	RESULT/NOTE
40.	Press:  	Returns to Master Menu and selects DISP (Display) Menu.
41.	Press: 	Selects REF (Reference) Mode. In REF mode, the stored trace becomes the reference and is displayed as 0 dB (Center Graticule) on the CRT display. The difference between the STORED (0 dB reference) and the current (LIVE) trace results in the signal displayed in Figure B-5.

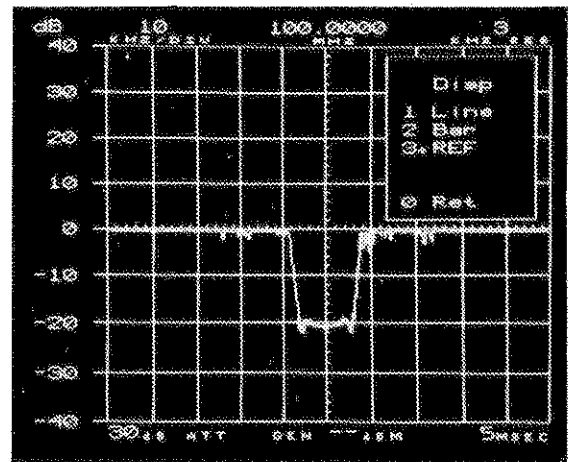



Figure B-5 REF Mode Display (20 dB ATTEN Difference)

42.	Press:  
-----	--

Sets RF ATTEN to 10 dB. The signal should now be represented, basically, as a straight line, as in Figure B-6. This display shows equal amplitude and frequency.

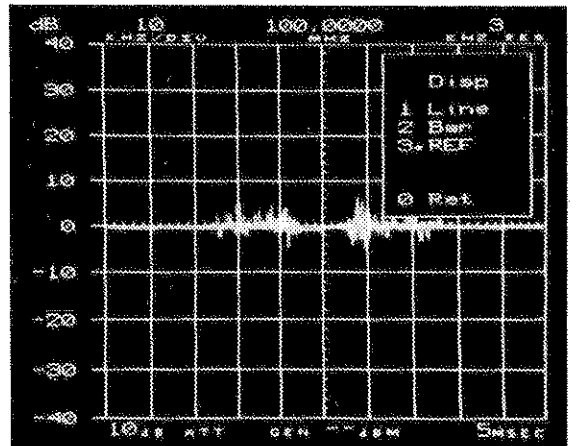





Figure B-6 REF Mode Signal Display









STEP	ACTION	RESULT/NOTE
43.	Press:   	Returns to Master Menu, selects MODE Menu and sets it to LIVE Mode.
44.	Press: 	Clears the Menu display from the CRT display.



















END OF TEST

B-2-2 75Ω OPERATION PROCEDURE

NOTE

This procedure can only be used if the 50-to-75Ω Adapter is available for your unit. The procedure requires a Signal Generator with 75Ω output impedance.

STEP	ACTION	RESULT/NOTE
1.	Connect 50-to-75Ω Adapter to ANALYZER INPUT Connector (10).	Enables A-7550 to operate at 75Ω impedance.
2.	Press:   	Enters Menu Mode and selects 75Ω operation in the SETUP Menu.
3.	Press: 	Selects unit for the Graticule Scale. Use the desired unit.
4.	Press 	Selects the MANUAL Menu.
5.	Press:  	Sets Bandwidth Optimization. Select AUTOMATIC (Bw = A)
6.	Press:  	Sets Sweep Rate Optimization. Select AUTOMATIC (Swp = A).

STEP	ACTION	RESULT/NOTE
7.	Press:  	Sets Auto Cal feature. Select ON (ACal = 1).
8.	Press:    	Returns to the Master Menu and selects the LINE display in the DISP Menu. (If LINE mode is selected previously and "1" is pressed, no "beep" will be heard.)
9.	Press:   	Returns to the Master Menu and selects the LIVE mode in the MODE menu. (If LIVE mode is selected previously and "5" is pressed, no "beep" will be heard.)
10.	Press:   	Returns to the Master Menu and selects NONE in the FILTERS Menu. (If NONE is selected previously and "1" is pressed, no "beep" will be heard.)
11.	Press:  nnnn.nnnn 	Sets the Center Frequency to RF Frequency of 75Ω Source.
12.	Press:  or 	Sets RF Attenuation ("ATT") to 10 dB.
13.	Set the Signal Generator as follows: a. RF Frequency = Same as in Step 11. b. MODULATION = NONE c. RF LEVEL = -30 dBm	
14.	Connect 75Ω Coax Cable between Signal Generator and 50-to-75Ω Adapter on A-7550.	The generated signal should measure -30 dBm.
15.	Disconnect the Signal Generator and 50-to-75Ω Adapter.	
16.	Press:   	Resets Graticule Scale and operational settings for 50Ω operation.





STEP	ACTION	RESULT/NOTE
17.	Press: 	Clears menu display from CRT.

END OF TEST

B-2-3 10.7 MHz FM/AM RECEIVER OPERATION PROCEDURE (OPTION)

NOTE

This procedure can only be used if the 10.7 MHz Receiver is installed in your A-7550 Spectrum Analyzer. If the RCVR menu is selected and the 10.7 MHz Receiver is not installed, the "OPTION NOT INSTALLED" Menu will be displayed in the menu window. Press "0" to return to the Master Menu.

STEP	ACTION	RESULT/NOTE
1.	Press:  nnn.nn  (n = 0 thru 9)	Set the Center Frequency to the frequency of a local radio or television station.
2.	Press:  	Enter the RCVR Menu.
3.	Press any key from 1 to 5.	Selects the numeric key equivalent of the modulation mode. 1 = FM1 4 = AM1 2 = FM2 5 = AM2 3 = SSB
4.	Press: 	Sets Scan Width to 0 kHz/DIV for fixed tune operation.

NOTE

When the set-up is complete, use the following procedure to test the 10.7 MHz FM/AM Receiver operation.



STEP

ACTION

RESULT/NOTE



CAUTION

OUTDOOR ANTENNAS MUST BE DISCHARGED BEFORE CONNECTING IT TO THE ANALYZER INPUT. STATIC DISCHARGE CAN CAUSE SERIOUS DAMAGE TO THE A-7550 SPECTRUM ANALYZER.

- | | | |
|----|--|---|
| 5. | Connect antenna to ANALYZER INPUT Connector (10). | Receives the signal. The demodulated audio is heard through the A-7550 speaker. |
| 6. | Vary SQUELCH (5) and VOLUME (12) Controls. | Verifies the Squelch Control squelches audio reception and the Volume Control increases and decreases speaker volume level. |
| 7. | Press:  | Sets Time Share Reception (TSR) to ON position (TSR = 1). |
| 8. | Press:  | Increases Scan Width and listens to demodulated audio. |

NOTE

During TSR operation, the speaker sounds increasingly disrupted as the sweep time becomes slower. Also, CERTAIN KEYS MAY APPEAR TO HAVE AN ACTION DELAY AS KEY ENTRIES ATTEMPTED DURING AUDIO RECEPTION ARE IGNORED (i.e., they are locked out by the controller).















- | | | |
|----|--|---|
| 9. | Press:   | Turns TSR OFF (TSR = 0) and clears the Menu from the CRT display. |
|----|--|---|

END OF TEST

B-2-4 TRACKING GENERATOR OPERATION PROCEDURE

NOTE

This procedure can only be performed if the Tracking Generator is installed in your A-7550 Spectrum Analyzer.

- | STEP | ACTION | RESULT/NOTE |
|------|--|--|
| 1. | Press:    | Turns the Tracking Generator ON (GEN = 1). |
| 2. | Press:  or  | Sets Tracking Generator level. Repeat until tracking level is -35 dBm. |
| 3. | Press:      | Sets the Center Frequency to 100.0 MHz. |
| 4. | Press:  or  | Sets RF Attenuation to 10 dB. |
| 5. | Connect TRACKING GENERATOR (17) to ANALYZER INPUT (20). | Uses 50Ω BNC-to-BNC Coax Cable. |
| 6. | Press:  | Decreases Scan Width. Repeat until Scan Width is set to 10 kHz/DIV. |
| 7. | Press:  | Sets Resolution Bandwidth. Repeat until Resolution Bandwidth is 3 kHz. Verify CRT display is as shown in Figure B-7. |

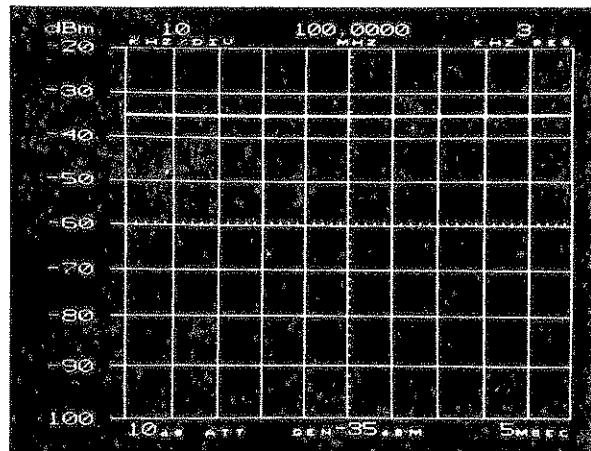







Figure B-7 Tracking Generator Display

STEP	ACTION	RESULT/NOTE
8.	Turn Tracking Adjust	Adjusts display for maximum signal amplitude.
9.	Press: 	Sets Graticule Scale to 2 dB/DIV.
10.	Press: 	Decreases Generator Output 1 dB. Repeat until Generator Output level decreases 10 dB. The CRT display should change at each 1 dB step.
11.	Press:  	Re-enters Master Menu and selects SETUP Menu.
12.	Press: 	Turns off Tracking Generator.
13.	Press: 	Clears menu display.

END OF TEST



APPENDIX C - CAPTURING A-7550 ANALYZER TRACES

C-1 GENERAL

The A-7550 Spectrum Analyzer is controlled by multiple microprocessors which direct the activity between its various subsystems. This allows a microprocessor to dedicate itself to a single task, such as processing the Remote Programming Language. The A-7550 Spectrum Analyzer accomplishes remote control via either the IEEE-488 Bus or the RS-232C Interface option (both options cannot be on one unit). The A-7550 remote control simulates keyboard control, as close as possible, to write and store traces.

C-2 WRITING AND STORING TRACES

The A-7550 analyzer display is a visual representation of the digitized samples taken by the analyzer's Sampler subsystem. This display is organized horizontally into 390 points. The amplitude for each point has a value from 0 to 479 from the analyzer base line to the top of the display window. Each sample point represents the actual frequency and amplitude level of the signal being digitized. (The value that is returned can be negative or as high as 600 to accommodate actual stored "REF" signal ratios.) Each point is computed using the following relationships:

Horizontal Unit Value = $\text{Scanwidth} / 39$
Vertical Unit Value = $(\text{Scale} * 8) / 479$
Top of Screen = $\text{RF ATTN} - \text{IF GAIN} + \text{BIAS}$
BIAS = -30 for dBm reference
= 20 for dBmV reference
= 80 for dBuV reference
Bottom of Screen = $\text{Top of Screen} - \text{Scale} * 8$
Left-hand Frequency = $\text{Center Frequency} - \text{Scanwidth} * 5$
Right-hand Frequency = $\text{Center Frequency} + \text{Scanwidth} * 5$

The following commands are used to compute and return these values:

RFATN? - Returns RF Attenuation value
IFGAIN? - Returns IF GAIN value
SCALE? - Returns 10, 2 or LINEAR
RFF? - Returns the Center Frequency
SCANW? - Returns the Scanwidth setting
REF? - Returns the Reference Scale (DBM, DBUW, DBV, DBMV or DBUV)

C-3 ANALYZER TRACE PREREQUISITES

Before a display can be returned to a host controller, the display must be stored. To store the display, use the Remote Command:

```
MODE=STORE
```

When the screen is stored, groups of ten points can be requested using the Remote Command:

```
GET(XX)?
```

Where XX is a value from 1 to 39.

The screen is divided into 39 horizontal groups of 10 points, which allows segments of the screen to be returned as the entire display may not be required for every user application of the A-7550. The GET(XX)? Command returns a maximum of 42 characters, including a carriage return and linefeed control characters. This line length is easily accepted by most compatible controllers and permits any of the 39 groups of ten sample points to be requested.

EXAMPLE

To return group 20 (horizontal points 200 through 209), enter the command:

```
GET(20)?
```

The response to this request might be:

```
101:104:105:110:120:121:122:122:122:123
```

This would be the stored values for an area near Center Frequency. To request an entire display, 39 individual GET(XX)? Commands must be requested from the analyzer.

EXAMPLE

Group 20, above, could be returned to the stored area of the A-7550 by entering the Remote Command:

```
PUT(20)=101:104:105:110:120:121:122:122:122:123
```

View the stored segment by entering the Remote Command:

```
MODE=RECALL
```

NOTE

The order in which these two commands are entered, in this context, is unimportant.

C-4 PROGRAMMING EXAMPLES

Communication between an external controller and the A-7550 requires some command and request subroutines to be written for either the IEEE-488 or RS-232 I/O ports. Using standard BASIC programming language routines, these are accomplished with INPUT and PRINT statements. Sample BASIC routines are given on the following pages for communications with the IBM^{T.M.} Personal Computer (and compatible units) and a Hewlett-Packard^{T.M.} model 85.

C-4-1 BASIC SUBROUTINES FOR COMMUNICATING WITH AN IBM-PCT^{T.M.}

To communicate with an RS-232 port, the following subroutine can be used:

```
1000 REM
      REM RS-232 RECEIVE ROUTINE
      REM
      REM RETURNS ASCII STRING IN IN$
      REM
      OPEN "COM1:9600,N,8,2,CD,DS" AS #1
      INPUT #1,IN$
      RETURN

2000 REM
      REM RS-232 OUTPUT ROUTINE
      REM
      REM SHIP ASCII STRING CONTAINED IN SEND$
      REM
      PRINT #1,SEND$
      RETURN
```

To communicate with an IEEE-488 port, the following subroutine can be used:

```
1000 REM
      REM IEEE-488 RECEIVE ROUTINE
      REM
      REM ADR$ = IEEE ADDRESS ON ENTRY
      REM
      IN$=SPACE$(50)
      CALL RECVST(ADR$,IN$)
      RETURN

2000 REM
      REM IEEE-488 TRANSMIT ROUTINE
      REM ADR$ = IEEE ADDRESS ON ENTRY
      REM SEND$ = COMMAND STRING
      REM
      SEND$=SEND$+CHR$(10)
      CALL SENDST(ADR$,SEND$)
      RETURN
```

C-4-2 BASIC SUBROUTINE FOR COMMUNICATING WITH A HEWLETT-PACKARD™
MODEL 85

To communicate with an HP-85™ through the IEEE-488 port, the following subroutine can be used:

```
1000 REM
      REM IEEE-488 INPUT ROUTINE
      REM
      ENTER N,I$
      RETURN

2000 REM
      REM IEEE-488 OUTPUT ROUTINE
      REM
      OUTPUT N,S$
      RETURN
```

C-4-3 BASIC SUBROUTINE TO REQUEST PARAMETERS

When the appropriate input and output routines have been written and fully tested, the parameters for the A-7550 can be requested per the following subroutine:

```
5000 REM
      REM ---( GET SCREEN PARAMETERS )---
      REM
      SEND$="RFATN?IFGAIN?SCALE?RFF?SCANW?"
      GOSUB 2000          ' SEND DATA
      GOSUB 1000         ' RECEIVE DATA
      GOSUB 3000         ' PARSE DATA INTO IN$()
      RFATN% = VAL(IN$(1))
      IFGAIN% = VAL(IN$(2))
      SCALE% = VAL(IN$(3))
      RFF = VAL(IN$(4))
      SCANW = VAL(IN$(5))
      TOP% = -30 + (RFATN% - IFGAIN%) ' ASSUME DMB REFERENCE
      BOT% = TOP% - (SCALE% * 8)
      DBDTO = (SCALE% * 8) / 479
      LRF = RFF - (SCANW * 5)
      RFF = RFF + (SCANW * 5)
      MHZDOT = (SCANW*10)/390
      RETURN
```

The following subroutines are called from the above routine.

```
3000 REM
      REM --( PARSE THE INPUT PARAMETERS )--
      REM
      CNT% = 0
```

```

3100 POSN%=INSTR(IN$,":") ' PARAMETERS ARE SEPARATED BY
                                COLONS
      IF(POSN% = 0) THEN 3200
      CNT% = CNT%+1
      IN$(CNT%) = LEFT$(IN$,POSN%-1)
      IN$=MID$(IN$,POSN%+1))
      GOTO 3100

3200 DNT% = CNT% +1
      IN$(CNT%)=IN$
      RETURN

```

C-4-4 BASIC SUBROUTINE TO SEND PARAMETERS

The following subroutine can be used to send parameters to the A-7550 and subsequently, read the A-7550 display.

```

7000 REM
      REM ( GET SCREEN OF DATA DOTS ( 0 - 389 ) )
      REM
      SEND$ = "MODE=STORE"
      GOSUB 2000
      ELEM% = 1
      FOR SLOOP1% = 1 TO 39 ' REQUEST ALL 39 GROUPS
      SEND$ = "GET("+MID$(STR$(SLOOP1%),2)+" )?" ' BUILD REQUEST
      GOSUB 2000 ' SEND DATA
      GOSUB 1000 ' RECEIVE DATA
      FOR SLOOP2% = 1 TO 9
        DOT%(ELEM%) = VAL(IN$) ' CONVERT STRING TO INTEGER
        IN$ = MID$(IN$,INSTR(IN$,"")+1) ' PARSE OVER COLONS
      ELEM% = ELEM% + 1
      NEXT SLOOP 1%
      RETURN

```

All 390 sample points in this example are stored as integers in the array DOT%. Using the known scaling factors for the analyzer environment, these points can be translated into actual Reference Scale and Frequency units.

Similar routines can be written for the controller being used locally. Routines can also be translated into PASCAL, "C" or FORTRAN, depending on the preferred language of the local controller.



APPENDIX D - A-7550 SIGNAL AMPLITUDE VALUES IN LINEAR MODE

Table D-1 contains values calculated for measuring Signal Amplitudes in linear mode, in .05 division intervals. Table D-1 values for X are computed from the formula: $X = 20 \log (D \div 8)$; and are applied to the following formula to compute the Signal Amplitude (A): $A = T + X$.

T is the Top of Screen value in dBm, dBμW, dBV, dBmV or dBμV. D is the number of divisions from the bottom graticule of the screen.

Div	X	Div	X	Div	X	Div	X
8.00	0.00	6.00	-2.50	4.00	-6.02	2.00	-12.04
7.95	-0.05	5.95	-2.57	3.95	-6.13	1.95	-12.26
7.90	-0.11	5.90	-2.64	3.90	-6.24	1.90	-12.49
7.85	-0.16	5.85	-2.72	3.85	-6.35	1.85	-12.72
7.80	-0.22	5.80	-2.79	3.80	-6.47	1.80	-12.96
7.75	-0.28	5.75	-2.87	3.75	-6.58	1.75	-13.20
7.70	-0.33	5.70	-2.94	3.70	-6.70	1.70	-13.45
7.65	-0.39	5.65	-3.02	3.65	-6.82	1.65	-13.71
7.60	-0.45	5.60	-3.10	3.60	-6.94	1.60	-13.98
7.55	-0.50	5.55	-3.18	3.55	-7.06	1.55	-14.26
7.50	-0.56	5.50	-3.25	3.50	-7.18	1.50	-14.54
7.45	-0.62	5.45	-3.33	3.45	-7.31	1.45	-14.83
7.40	-0.68	5.40	-3.41	3.40	-7.43	1.40	-15.14
7.35	-0.74	5.35	-3.49	3.35	-7.56	1.35	-15.46
7.30	-0.80	5.30	-3.58	3.30	-7.69	1.30	-15.78
7.25	-0.86	5.25	-3.66	3.25	-7.82	1.25	-16.12
7.20	-0.92	5.20	-3.74	3.20	-7.96	1.20	-16.48
7.15	-0.98	5.15	-3.83	3.15	-8.10	1.15	-16.85
7.10	-1.04	5.10	-3.91	3.10	-8.23	1.10	-17.23
7.05	-1.10	5.05	-4.00	3.05	-8.38	1.05	-17.64
7.00	-1.16	5.00	-4.08	3.00	-8.52	1.00	-18.06
6.95	-1.22	4.95	-4.17	2.95	-8.67	0.95	-18.51
6.90	-1.28	4.90	-4.26	2.90	-8.81	0.90	-18.98
6.85	-1.35	4.85	-4.35	2.85	-8.96	0.85	-19.47
6.80	-1.41	4.80	-4.44	2.80	-9.12	0.80	-20.00
6.75	-1.48	4.75	-4.53	2.75	-9.28	0.75	-20.56
6.70	-1.54	4.70	-4.62	2.70	-9.43	0.70	-21.16
6.65	-1.61	4.65	-4.71	2.65	-9.60	0.65	-21.80
6.60	-1.67	4.60	-4.81	2.60	-9.76	0.60	-22.50
6.55	-1.74	4.55	-4.90	2.55	-9.93	0.55	-23.25
6.50	-1.80	4.50	-5.00	2.50	-10.10	0.50	-24.08
6.45	-1.87	4.45	-5.09	2.45	-10.28	0.45	-25.00
6.40	-1.94	4.40	-5.19	2.40	-10.46	0.40	-26.02
6.35	-2.01	4.35	-5.29	2.35	-10.64	0.35	-27.18
6.30	-2.07	4.30	-5.39	2.30	-10.83	0.30	-28.52
6.25	-2.14	4.25	-5.49	2.25	-11.02	0.25	-30.10
6.20	-2.21	4.20	-5.60	2.20	-11.21	0.20	-32.04
6.15	-2.28	4.15	-5.70	2.15	-11.41	0.15	-34.54
6.10	-2.36	4.10	-5.81	2.10	-11.62	0.10	-38.06
6.05	-2.43	4.05	-5.91	2.05	-11.83	0.05	-44.08
						0.01	-58.06

Table D-1 A-7550 Signal Amplitude (A) Values for $X = 20 \log (D \div 8)$



APPENDIX E - OPTIMIZATION OF RESOLUTION BANDWIDTHS AND SWEEP RATES

Optimization allows the A-7550 to automatically select a Resolution Bandwidth and Sweep Rate for most Scan Width settings. The settings are based upon the behavior of the A-7550 Spectrum Analyzer. When active, the Scan Width setting determines the Resolution Bandwidth setting. The combination of the Scan Width and Resolution Bandwidth settings determine the Scan Width setting.

E-1 BANDWIDTH OPTIMIZATION

When Bandwidth Optimization is active, changing the Scan Width changes the Resolution Bandwidth per Table E-1. The Resolution Bandwidth can be reset to any value, unless changing the Resolution Bandwidth results in an "Uncal" condition. The Uncal condition occurs when the Sweep Rate is set too fast to accurately measure signal amplitudes. (The Resolution Bandwidth is also set too narrow for the selected Scan Width at the selected Sweep Rate.)

SCAN WIDTH	RES B/W
0 kHz/DIV	300 Hz
1 kHz/DIV	300 Hz
2 kHz/DIV	300 Hz
5 kHz/DIV	3 kHz
10 kHz/DIV	3 kHz
20 kHz/DIV	3 kHz
50 kHz/DIV	30 kHz
100 kHz/DIV	30 kHz
200 kHz/DIV	30 kHz
500 kHz/DIV	30 kHz
1 MHz/DIV	300 kHz
2 MHz/DIV	300 kHz
5 MHz/DIV	300 kHz
10 MHz/DIV	300 kHz
20 MHz/DIV	3 MHz
50 MHz/DIV	3 MHz
100 MHz/DIV	3 MHz

Table E-1 Optimal Resolution Bandwidth Settings

E-2 SWEEP RATE OPTIMIZATION

When Sweep Rate and Resolution Bandwidth Optimization are both active, the Scan Width keys and Res B/W keys work together to select an optimal Sweep Rate per Tables E-2 through E-4.

Table E-2 shows optimized Sweep Rate settings without video filtering. The Sweep Rates may be reset to any slower value. If a faster value is selected, an "UNCAL" condition occurs.

SCAN WIDTH	BANDWIDTH				
	300 Hz	3 kHz	30 kHz	300 kHz	3 MHz
0 kHz/DIV	5 mSEC	5 mSEC	5 mSEC	5 mSEC	5 mSEC
1 kHz/DIV	50 mSEC	5 mSEC	5 mSEC	5 mSEC	5 mSEC
2 kHz/DIV	.1 SEC	5 mSEC	5 mSEC	5 mSEC	5 mSEC
5 kHz/DIV	.2 SEC	5 mSEC	5 mSEC	5 mSEC	5 mSEC
10 kHz/DIV	.5 SEC	10 mSEC	5 mSEC	5 mSEC	5 mSEC
20 kHz/DIV	Uncal	20 mSEC	5 mSEC	5 mSEC	5 mSEC
50 kHz/DIV	Uncal	50 mSEC	10 mSEC	5 mSEC	5 mSEC
100 kHz/DIV	Uncal	.1 SEC	10 mSEC	5 mSEC	5 mSEC
200 kHz/DIV	Uncal	Uncal	20 mSEC	5 mSEC	5 mSEC
500 kHz/DIV	Uncal	Uncal	50 mSEC	5 mSEC	5 mSEC
1 MHz/DIV	Uncal	Uncal	.1 SEC	10 mSEC	5 mSEC
2 MHz/DIV	Uncal	Uncal	Uncal	20 mSEC	5 mSEC
5 MHz/DIV	Uncal	Uncal	Uncal	50 mSEC	5 mSEC
10 MHz/DIV	Uncal	Uncal	Uncal	.1 SEC	10 mSEC
20 MHz/DIV	Uncal	Uncal	Uncal	Uncal	20 mSEC
50 MHz/DIV	Uncal	Uncal	Uncal	Uncal	50 mSEC
100 MHz/DIV	Uncal	Uncal	Uncal	Uncal	50 mSEC

Table E-2 Sweep Rate Optimization With No Video Filter

EXAMPLE: Select the following:

Scan Width = 100 kHz/DIV
 Res B/W = 3 kHz
 Sweep Rate = 10 mSec/DIV

"UNCAL" should now appear in the upper-left corner of the CRT instead of the graticule unit. Increase the Sweep Rate value until the "UNCAL" message is replaced by the graticule units. This is the fastest sweep rate setting that should be selected for measurements on the A-7550 using the specified Scan Width and Sweep Rate settings. (Find this value on Table E-2.)

Table E-3 shows optimized Sweep rate settings with the 300 Hz Video Filter turned on. As in Table E-2, Sweep Rates may be reset to any slower value than the optimized setting. Faster Sweep Rate settings result in an "UNCAL" condition.

SCAN WIDTH	BANDWIDTH				
	300 Hz	3 kHz	30 kHz	300 kHz	3 MHz
0 kHz/DIV	5 mSEC	5 mSEC	5 mSEC	5 mSEC	5 mSEC
1 kHz/DIV	.1 SEC	10 mSEC	5 mSEC	5 mSEC	5 mSEC
2 kHz/DIV	.1 SEC	20 mSEC	5 mSEC	5 mSEC	5 mSEC
5 kHz/DIV	.5 SEC	20 mSEC	5 mSEC	5 mSEC	5 mSEC
10 kHz/DIV	.5 SEC	.1 SEC	10 mSEC	5 mSEC	5 mSEC
20 kHz/DIV	Uncal	.2 SEC	20 mSEC	5 mSEC	5 mSEC
50 kHz/DIV	Uncal	.2 SEC	50 mSEC	10 mSEC	5 mSEC
100 kHz/DIV	Uncal	.5 SEC	.1 SEC	20 mSEC	5 mSEC
200 kHz/DIV	Uncal	Uncal	.1 SEC	50 mSEC	5 mSEC
500 kHz/DIV	Uncal	Uncal	.2 SEC	.1 SEC	20 mSEC
1 MHz/DIV	Uncal	Uncal	.5 SEC	.2 SEC	50 mSEC
2 MHz/DIV	Uncal	Uncal	Uncal	.5 SEC	50 mSEC
5 MHz/DIV	Uncal	Uncal	Uncal	1 SEC	50 mSEC
10 MHz/DIV	Uncal	Uncal	Uncal	2 SEC	.1 SEC
20 MHz/DIV	Uncal	Uncal	Uncal	Uncal	.1 SEC
50 MHz/DIV	Uncal	Uncal	Uncal	Uncal	.2 SEC
100 MHz/DIV	Uncal	Uncal	Uncal	Uncal	.2 SEC

Table E-3 Sweep Rate Optimization With 300 Hz Video Filter

Table E-4 shows optimized Sweep Rate settings with the 30 kHz Video Filter turned on. Again, Sweep Rates may be reset to any slower Sweep Rate value than the optimized setting. Faster Sweep Rate settings result in an "UNCAL" condition.

SCAN WIDTH	BANDWIDTH				
	300 Hz	3 kHz	30 kHz	300 kHz	3 MHz
0 kHz/DIV	5 mSEC	5 mSEC	5 mSEC	5 mSEC	5 mSEC
1 kHz/DIV	50 mSEC	5 mSEC	5 mSEC	5 mSEC	5 mSEC
2 kHz/DIV	.1 SEC	5 mSEC	5 mSEC	5 mSEC	5 mSEC
5 kHz/DIV	.2 SEC	5 mSEC	5 mSEC	5 mSEC	5 mSEC
10 kHz/DIV	.5 SEC	10 mSEC	5 mSEC	5 mSEC	5 mSEC
20 kHz/DIV	Uncal	20 mSEC	5 mSEC	5 mSEC	5 mSEC
50 kHz/DIV	Uncal	50 mSEC	10 mSEC	5 mSEC	5 mSEC
100 kHz/DIV	Uncal	.1 SEC	10 mSEC	5 mSEC	5 mSEC
200 kHz/DIV	Uncal	Uncal	20 mSEC	5 mSEC	5 mSEC
500 kHz/DIV	Uncal	Uncal	50 mSEC	5 mSEC	5 mSEC
1 MHz/DIV	Uncal	Uncal	.1 SEC	10 mSEC	5 mSEC
2 MHz/DIV	Uncal	Uncal	Uncal	20 mSEC	5 mSEC
5 MHz/DIV	Uncal	Uncal	Uncal	50 mSEC	5 mSEC
10 MHz/DIV	Uncal	Uncal	Uncal	.1 SEC	10 mSEC
20 MHz/DIV	Uncal	Uncal	Uncal	Uncal	20 mSEC
50 MHz/DIV	Uncal	Uncal	Uncal	Uncal	50 mSEC
100 MHz/DIV	Uncal	Uncal	Uncal	Uncal	50 mSEC

Table E-4 Sweep Rate Optimization with 30 kHz Video Filter

E-3 MANUAL OPTIMIZATION

Optimization can be turned on or off via menu operation. Both the Resolution Bandwidth and the Sweep Rate Optimization functions can be set independently, as described in Paragraph 4-10.

Turning off Resolution Bandwidth Optimization affects only Resolution Bandwidth settings. That is, changing the Scan Width does not cause the Resolution Bandwidth to change. The Sweep Rate setting may still change. If Resolution Bandwidth Optimization is turned off, "M→" appears in the upper right corner of the CRT display. The arrow points to the Resolution Bandwidth display. If optimization is turned on, this block is blank.

Turning off Sweep Rate Optimization affects only Sweep Rate settings. That is, changing either the Scan Width or the Resolution Bandwidth does not cause the Sweep Rate to change. If Scan Width Optimization is turned off, "M→" appears in the lower-right corner of the CRT display. The arrow points to the Sweep Rate display. If optimization is turned on, the block is blank.

If Resolution Bandwidth Optimization and Sweep Rate Optimization are both turned off, then changing the Scan Width affects neither the Resolution Bandwidth nor the Sweep Rate settings. Also, changing the Resolution Bandwidth has no affect on the Sweep Rate. The "M→" is displayed in both applicable blocks on the CRT.

APPENDIX F - REPACKING FOR SHIPMENT

F-1 SHIPPING INFORMATION

IFR test sets returned to factory for calibration, service or repair must be repackaged and shipped subject to the following conditions:

Do not return any products to factory without first receiving authorization from IFR Customer Service Department.

CONTACT: Customer Service Dept.
IFR Systems, Inc.
10200 West York Street
Wichita, Kansas 67215

Telephone: (800)-835-2350
TWX: 910-741-6952

All test sets must be tagged with:

- a. Owner's identification, address, and telephone number.
- b. Nature of service or repair required.
- c. Model No.
- d. Serial No.

Sets must be repackaged in original shipping containers using IFR packing models. If original shipping containers and materials are not available, contact IFR Customer Service Dept. for shipping instructions.

All freight costs on non-warranty shipments are assumed by customer. (See "Warranty Packet" for freight charge policy on warranty claims.)

F-2 REPACKING PROCEDURE (Reference - Figure F-1)

1. Make sure bottom packing mold is seated on floor of shipping container.
2. Carefully wrap test set with polyethylene sheeting to protect finish.
3. Place test set into shipping container, making sure set is securely seated in bottom packing mold.
4. Place top packing mold over top of set and press down until mold rests solidly on bottom packing mold.
5. Close shipping container lids and seal with shipping tape or an industrial stapler. Tie all sides of container with break-resistant rope, twine or equivalent.

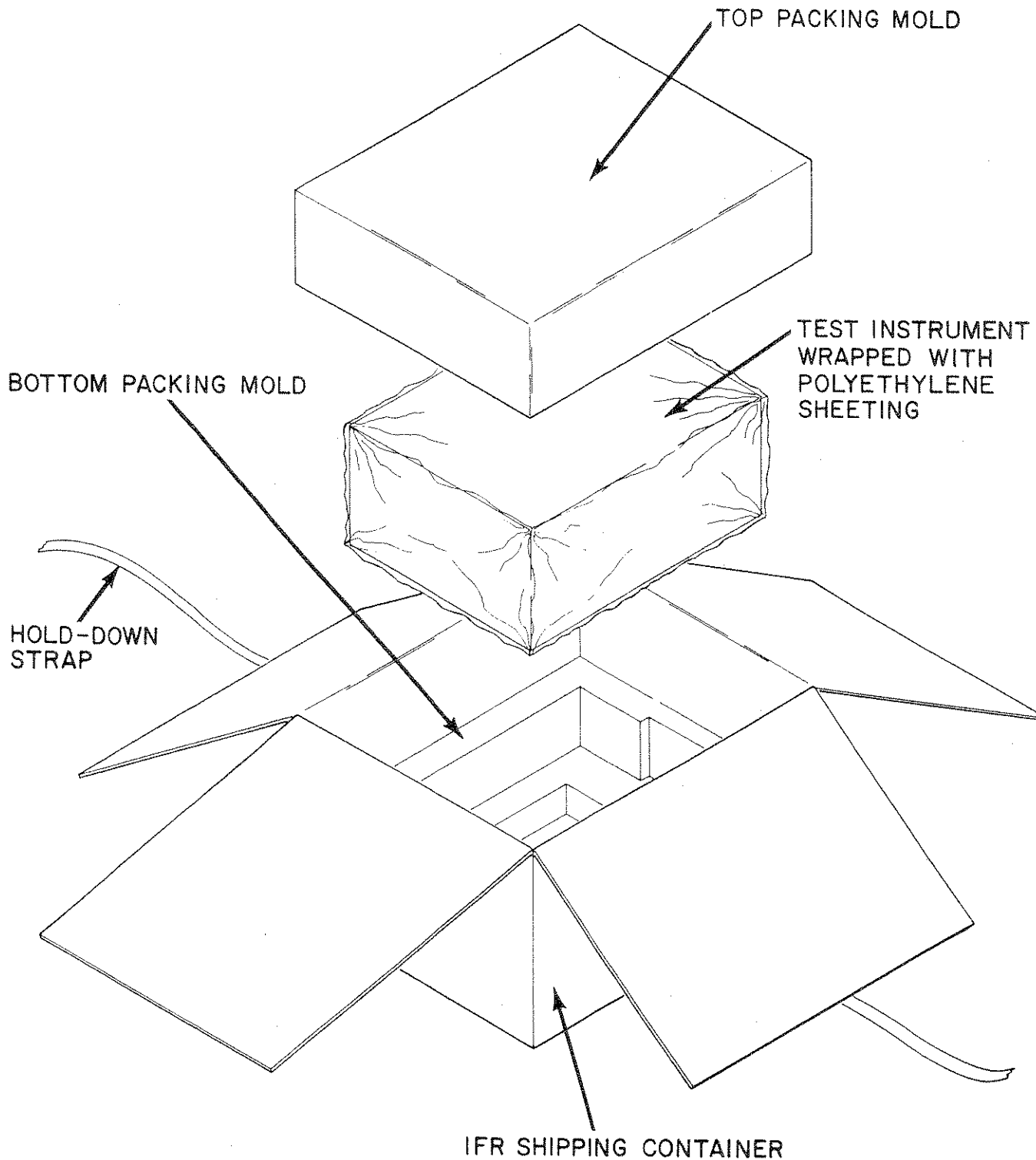

Figure F-1 Repacking for Shipment

APPENDIX G - LIST OF ABBREVIATIONS AND SYMBOLS

Following are the abbreviations and symbols, listed alphabetically, used in this manual. GPIB and RS-232 mnemonic codes are defined in Sections 5 and 6, respectively.

AC	- Alternating Current or Automatic Calibration (also Ac, Acal, or Auto Cal)
AM	- Amplitude Modulation
ANSI	- American National Standards Institute
ASCII	- American Standard Code for Information Interchange
AVE	- Average Mode
BATT	- Battery (also Bat)
Bw	- Bandwidth (also B/W)
CAL	- Calibration
CISPR	- Comite International Special des Perturbations Radioelectroniques (Special International Committee for the Study of Radio and Electronic Interferences)
COMP	- Compare Mode
CRT	- Cathode Ray Tube
CW	- Continuous Wave
dB	- Decibel(s)
dBm	- Decibels relative to Milliwatts
dBmV	- Decibels relative to Millivolts
dBuV	- Decibels relative to Microvolts
dBuW	- Decibels relative to Microwatts
dBV	- Decibels relative to Volts
DC	- Direct Current
DISP	- Display Menu
EMI	- Electromagnetic Interference
EXT AMP	- External Amplifier Connector
FCC	- Federal Communications Commission
FILT	- Filters Menu
FM	- Frequency Modulation
GEN	- Generator
GHz	- GigaHertz (10^9 Hertz)
GPIB	- General Purpose Interface Bus
Hz	- Hertz (cycles per second)
IEEE	- Institute of Electrical and Electronics Engineers
IF	- Intermediate Frequency
kHz	- kiloHertz (10^3 Hertz)

LIN - Linear Scale or Mode
 LISN - Line Impedance Stabilization Network
 LPF - Low-pass Filter

M - Manual Indicator
 MHz - MegaHertz (10^6 Hertz)
 M Ω - MegOhms (10^6 Ohms)
 mSec - Milliseconds (10^{-3} Seconds)
 mVDC - Millivolts, Direct Current

n... - Unspecified numeric value

Ω - Ohm(s)

PWR - Power Switch
 PkHold - Peak Hold Mode

RAM - Random Access Memory
 RCVR - Receiver Menu
 RES B/W - Resolution Bandwidth
 REF - Reference Display
 RET - Return to previous menu
 RF - Radio Frequency
 RMS - Root Mean Square
 ROM - Read-only Memory

SSB - Single Side Band
 Swp - Sweep (Rate)

TC - Time Constant
 TSR - Time Share Reception

UUT - Units Under Test

V - Volts
 VAC - Volts, Alternating Current
 VDC - Volts, Direct Current
 VRS - Vertical Raster Scan
 VSWR - Voltage Standing Wave Ratio