

AM/FM STEREO TUNER

TX-9800

OPERATING INSTRUCTIONS

KU



Walnut grained vinyl top and side panels are used in the construction of this cabinet.

Before operating your TX-9800 AM/FM STEREO TUNER, please read these Operating Instructions through and then you will know how to connect the stereo tuner properly and operate the tuner correctly. This will ensure that you enjoy the stereo performance to the full.

After reading these instructions, keep them in a safe place together with the warranty card. Then you will know exactly where it is in case you wish to refer to it.

CONTENTS

Features	2
Connection Diagram	3
Installation Precautions.....	3
Connections	4
Antenna and Ground Connections	4
Front Panel Facilities	6
Listening to Broadcasts.....	7
Accessory Functions.....	8
FM-Dolby Reception	8
Installing the FM Antenna	9
FM Multipath Distortion	10
Specifications	11
Conditions Frequently Mistaken for Malfunctions	12
Schematic Diagram	Insertion

IMPORTANT NOTICE

The serial number for this equipment is located on the rear panel. Please write this serial number on your enclosed warranty card and keep in a secure area. This is for your security.

WARNING: TO PREVENT FIRE OR SHOCK HAZARD, DO NOT EXPOSE THIS APPLIANCE TO RAIN OR MOISTURE.

 PIONEER

FEATURES

RF Amplifier 2-stage FM Front End with 5-gang Variable Capacitor

The RF amplifier 2-stage front end incorporates a 5-gang variable capacitor and three dual-gate MOS FETs. A capacitance-coupled double tuned circuit is inserted between the RF amplifier stages. Those features produce impressive characteristics, such as an IHF sensitivity of 8.8dBf, a spurious response of over 110dB and an image interference ratio of over 120dB.

oscillation variable capacitor, and very fine and accurate tracking adjustments are performed in order to greatly improve the scale accuracy.

Quartz Sampling Locked FM-APC Circuit for Optimum Tuning Point

An automatic phase control (APC) circuit is adopted so as to safeguard against drift in the local oscillation frequency caused by fluctuations in the temperature and humidity. The frequency of the output signal from the highly accurate quartz crystal oscillator is demultiplied down to 100kHz and used as the reference signal. This enables the frequency signal of the broadcasting station to be locked properly, and allows the tuner to maintain the optimum tuning point when receiving signals over prolonged periods of time or when recording programs on the air.

Touch Sensor FM Tuning Lock System

This tuner features a touch tuning system. Its quartz sampling locked APC circuit, which locks the optimum tuning point, swings into action as soon as you remove your hand from the tuning knob after you have tuned in a station. When the tuning knob is rotated and the signals from the broadcasting station are picked up, the TUNE indicator comes on as soon as you arrive at the optimum tuning point, and when you remove your hand from the tuning knob, the touch sensor enables or allows the APC circuit to be activated and the signals to be locked to the optimum tuning point. At the same time, the LOCKED indicator comes on to indicate that the stable reception mode is being maintained.

Selectable Bandwidth FM-AM IF Amplifier

According to the signal conditions, the FM-AM IF amplifier can be selected for wide band (high fidelity) and narrow band (high selectivity) modes in order to improve both the sound quality and the reception performance.

A dual-element linear phase ceramic filter which possesses an excellent group delay response is used for the FM wide-band mode. This helps to reduce distortion and improve separation and the overall performance, and also provide high-fidelity FM reception with a good linearity.

A 10-element linear phase ceramic filter is used for the narrow-band mode to obtain a usable selectivity of 85dB. In addition, interference-free reception becomes possible even in locations where a strong interference signal is adjacent to the station whose signals you are tuning in.

The same type of configuration is featured for the AM section. A 3-pole, 7-element LC bandpass filter is used for the AM wide-band mode, and a narrow-band ceramic filter added to above filter is employed for the narrow band mode. As a result, interference and beat are suppressed and the signals which are received always yield the optimum sound quality.

MPX Circuitry Adopting PLL IC with Built-in Automatic Pilot Signal Cancelling Circuit

The FM demodulator employs a negative feedback PLL MPX IC with a built-in automatic pilot signal cancelling circuit. This enables the pilot signal to be cancelled out automatically without compromising the high-range frequencies.

High-performance AM Tuner with IC

The AM tuner incorporates a linear frequency 3-gang variable capacitor tuned type of RF amplifier circuit and a highly sensitive, low distortion IC. These features increase the image interference and IF interference rejection capabilities of the tuner. An optimum AGC voltage is supplied to each section, providing stable reception with low spurious interference and distortion even in localities with strong field strength areas.

High-accuracy Design for Sure-fire Reliability

The dial scale features a solid diamond-cut finish, proof enough of the very high accuracy it can guarantee. Moreover, the large-sized meters for easy read-out and the lever switches crafted for the best in handling ease help make up the overall design which virtually radiates with quality and sophistication.

CONNECTION DIAGRAM

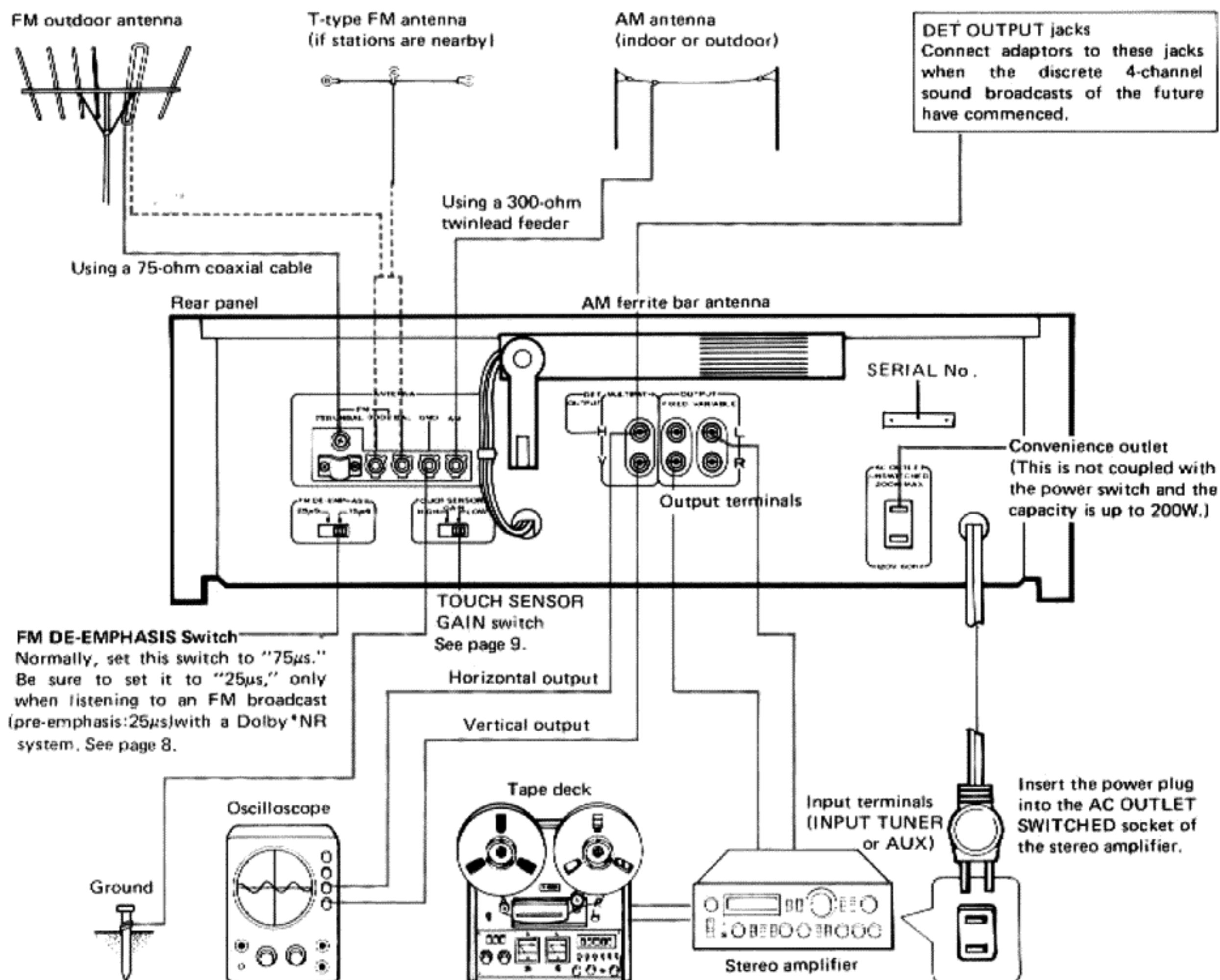

*The word "Dolby" is a trademark of Dolby Laboratories.

INSTALLATION PRECAUTIONS

To ensure a long and reliable performance, avoid installing this model in any of the following locations:

Locations to be avoided	Possible detrimental effects
<ol style="list-style-type: none"> Locations exposed to the sun or heat radiated by heaters, on top of heat-generating power amplifiers, near power transformers. Locations which are not properly ventilated, and locations with a high humidity or moisture content. Do not place vases or gold fish bowls on top of the tuner. Locations where there are alcohol, benzine and other volatile chemicals in the vicinity. Take care not to bring sprays like insecticides near the tuner. 	<ol style="list-style-type: none"> External heating can cause the circuit components to deteriorate and it may prevent stable operation. Humidity and moisture can cause defective insulation, and adversely affect the performance of the precision circuit components. Chemicals can corrode the panels and chassis and change their coloring.

CONNECTIONS

Connection Precautions

- The tuner's output jacks as well as the connecting jacks on the stereo amplifier, one being for the left (L) channel and the other for the right (R) channel. Make sure that you connect L to L and R to R correctly.
- Plug the connecting cords firmly into the jacks; loose connections can generate noise.
- Do not bundle the input and output cords with the power and speaker cords. Also avoid using cords which are longer than required and bunching them. These practices can result in noise, impaired sound quality, and possible operating difficulties.

CONNECTIONS TO A STEREO AMPLIFIER

Use the accessory pin plug connecting cords to connect the TUNER or AUX jacks of the stereo amplifier with the output jacks (VARIABLE) of the tuner.

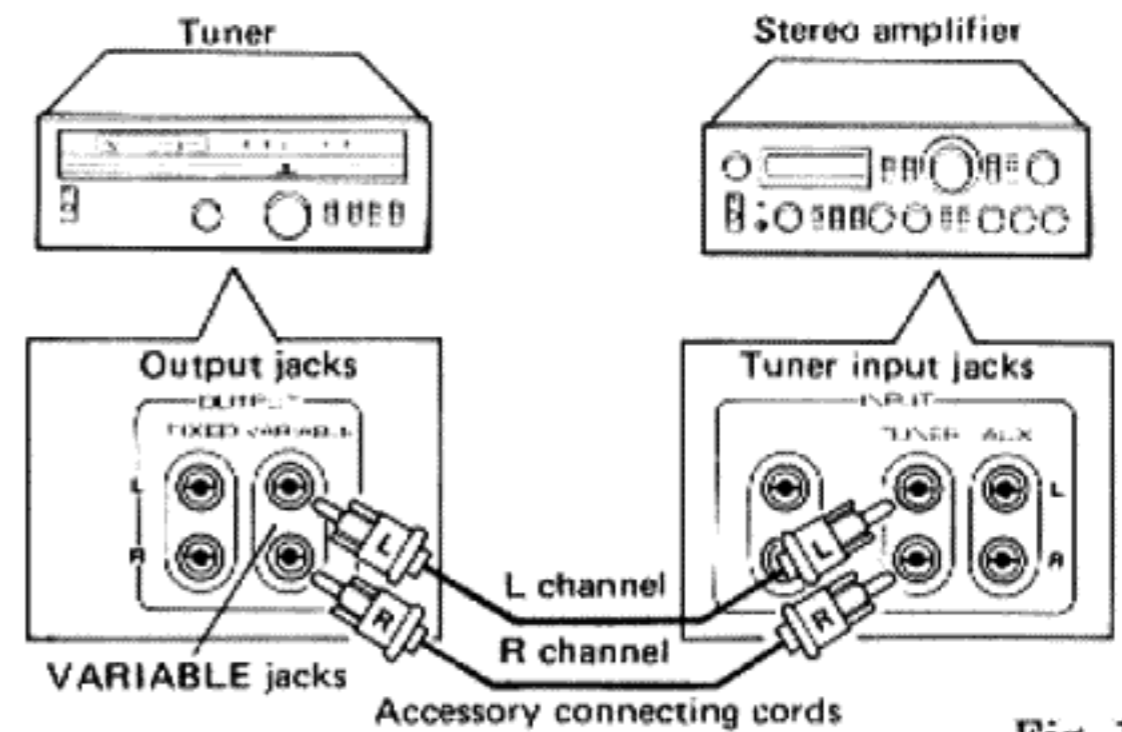

Fig. 1

ANTENNA AND GROUND CONNECTIONS

FM ANTENNAS

There are two methods you can use when connecting the FM antenna to the antenna input terminals: you can use a 300-ohm twinlead feeder or a 75-ohm coaxial cable.

Pioneer recommends the 75-ohm coaxial cable (RG59U, etc.) if you want your tuner to display its capabilities to the full. The coaxial cable is more effective than the twinlead feeder in safeguarding against external interference noise from impairing the sound quality. In other words, twinlead feeders are liable to pick up external noise, and this is why they are not recommended.

CONNECTIONS USING A 75-OHM COAXIAL CABLE

Refer to Fig. 2 and follow the procedure. Prepare the tip of the coaxial cable and connect it to the antenna input terminal (75Ω-UNBAL).

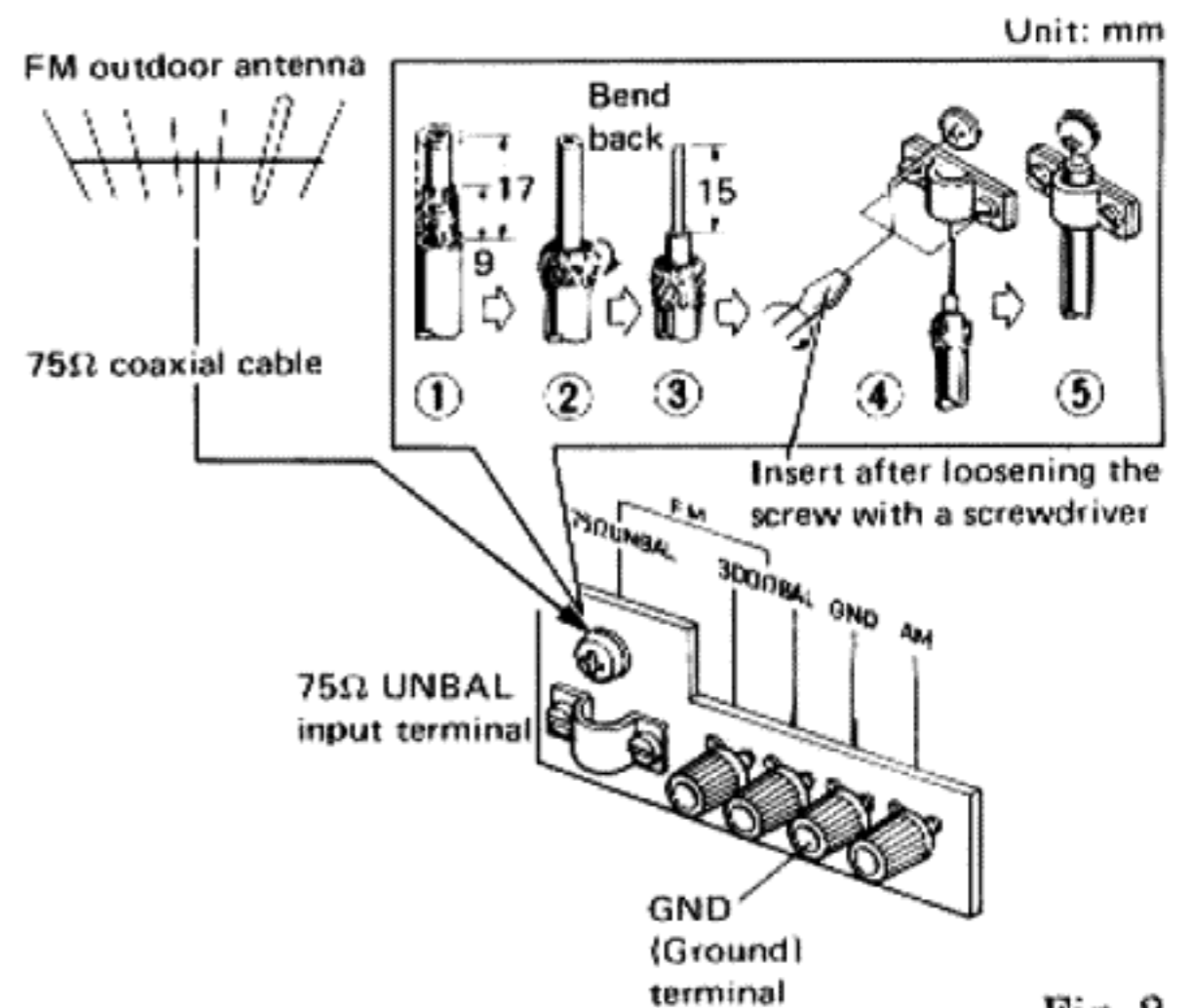

Fig. 2

CONNECTIONS USING A 300-OHM TWINLEAD FEEDER

In cases where it is only possible to use a twinlead feeder with a community receiving system antenna, refer to Fig. 3 and follow the procedure. Prepare the ends of the twinlead feeder and attach them to the 300Ω-BAL antenna input terminals. Then make the twinlead feeder as short as possible but do not bundle the wires or run them loose on the floor.

ACCESSORY T-TYPE ANTENNA

This antenna is designed to allow you to receive FM programs in areas where strong signals are beamed by broadcasting stations until you install your FM antenna. As shown in Fig. 3, attach the antenna to the 300Ω-BAL antenna input terminals and then tune into an FM station, following the instructions listed under "LISTENING TO BROADCASTS" on page 7. Extend both ends of the antenna horizontally, locate the optimum receiving location by moving the antenna to the left or right, or up or down, and then secure it to the ceiling or wall.

AM ANTENNAS

While listening to AM stations (see AM Reception on page 7), move the rear panel ferrite bar antenna and position it for best reception.

- Select the desired AM station, and move the bar antenna around in every direction and then set it at the position where the best reception is obtained.
- In cases when the bar antenna is insufficient for adequate reception, an indoor AM antenna can be made from a length (5 to 6 meters) of vinyl insulated wire. As shown in Fig. 5, connect one end of the wire to the AM antenna terminal and suspend the free end from a wall or ceiling at as high a location as possible.
- If reception is still difficult with an indoor antenna, use vinyl insulated wire to erect an outdoor AM antenna between two supports as shown in Fig. 5.

GROUNDING

From the viewpoint of both safety and reduced noise, Pioneer recommends that you employ a ground as shown in Fig. 5. Connect the ground lead to the GND terminal of the tuner. Never connect it to a gas pipe or other dangerous location.

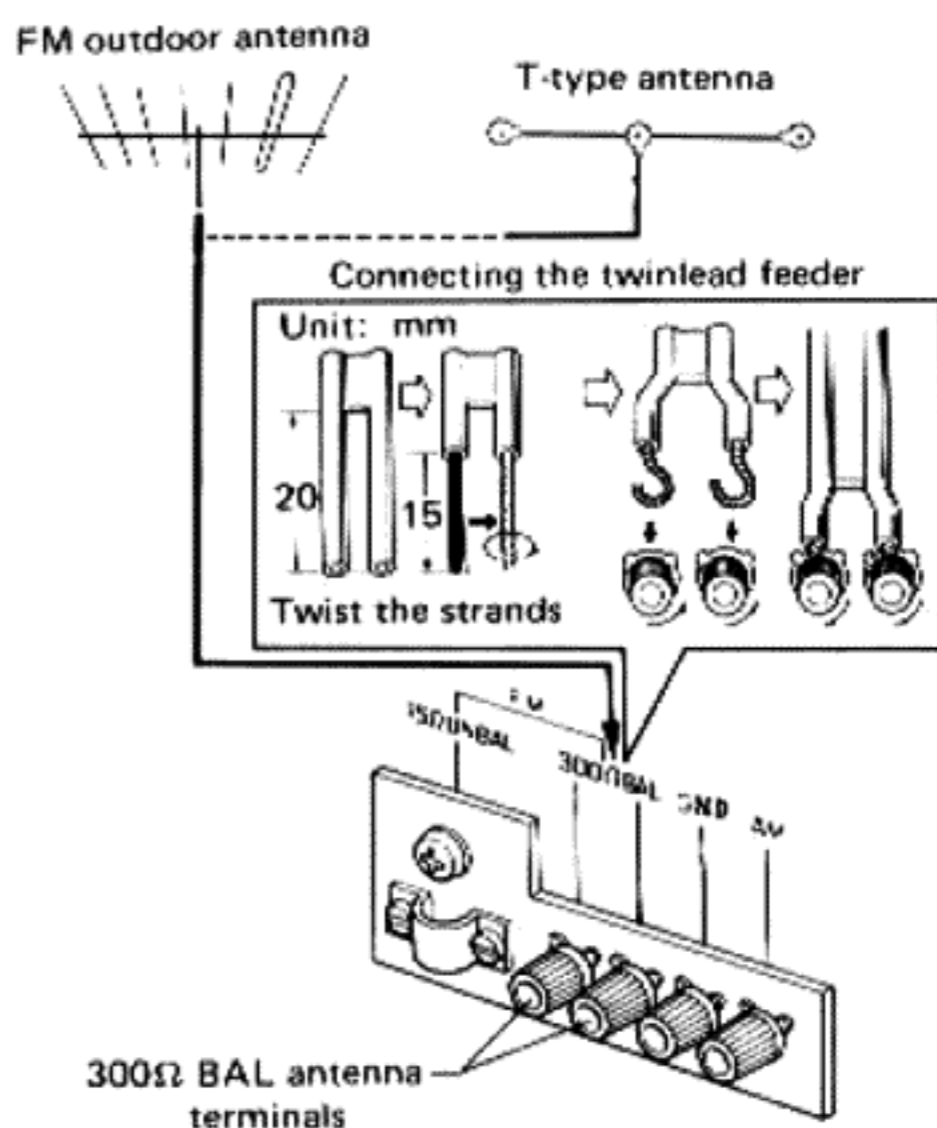

Fig. 3

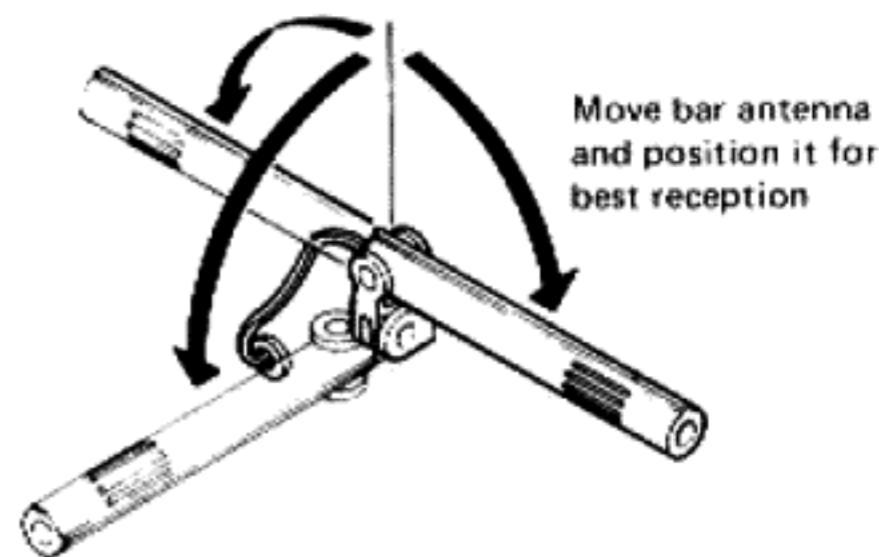

Fig. 4

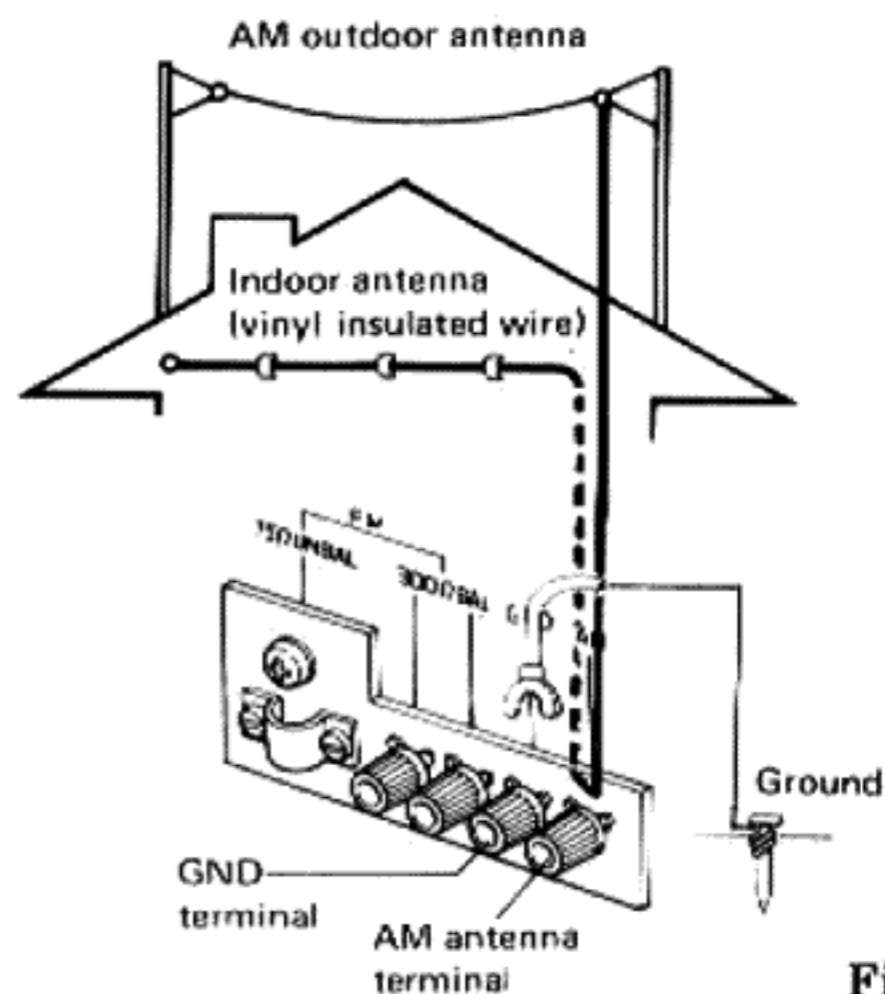

Fig. 5

FRONT PANEL FACILITIES

POWER SWITCH

Set to ON position to turn on power. Pilot lamp will light.

SIGNAL METER

This meter indicates the antenna input level of the AM and FM broadcasting waves. The higher the input level, the more the meter deflects toward right. When selecting the desired station, find the position of the tuning knob which effects the maximum deflection of the meter pointer. When selecting an FM station, also observe the tuning meter to determine the optimum tuning point.

MEMORY MARKERS

Convenient for designating most often tuned in stations. Slide markers with fingertip to desired positions.

TUNING METER

This meter indicates the optimum tuning point irrespective of the field strength when selecting an FM station. With no signal, the pointer remains at the center; as a signal is tuned in, it deflects to the right or left; when the signal is tuned in accurately, the pointer will correctly move to the center of the scale. If the tuning knob is adjusted further, the pointer deflects to the right or left; as the signal moves off completely, the pointer returns to the center position again.

FM-STEREO INDICATOR

This indicator lights up when the tuner is receiving a stereo program if the FM MUTING/MODE switch is set to AUTO.

FM-TUNE INDICATOR

This indicator lights up when the optimum tuning point is obtained.

FM/AM INDICATORS

These indicators light up during an FM or AM reception, respectively.

FM-LOCKED INDICATOR

With the function switch set to FM and the FM muting/mode switch set to ON, this indicator lights up when you take your hand off the tuning knob at the optimum tuning point. This light indicates that the quartz locking circuit has been activated by the built-in touch sensor detector circuit and the frequency of the circuit is locked to the frequency of the station.

FM MUTING/MODE SWITCH

When this switch is set to ON, unpleasant interstation noise is eliminated, which makes selection of stations easier. However, if the muting switch is set to ON in areas where the field strength is extremely weak, the station being received may also disappear. In such areas, therefore, the muting switch should be turned OFF. When this switch is set to OFF, monaural reception will be obtained even though the station is broadcasting a stereo program.

MPX NOISE FILTER SWITCH

If a comparatively high frequency noise is noticed during reception of a stereo program, this switch is set to ON. Stereo separation will thereby somewhat deteriorate. This switch should normally be kept OFF.

OUTPUT LEVEL KNOB

This knob is used to adjust the output level of the variable output jacks. When it is rotated in the direction of MAX, the output level is increased. For further details, refer to "OUTPUT LEVEL KNOB" on page 8.

TUNING KNOB

This knob is used for selecting stations. When selecting an AM station, observe the signal meter, and when selecting an FM station, observe both the signal meter and the tuning meter.

FUNCTION SWITCH

This switch is used to select the type of broadcasting waves.

FM For reception of FM broadcasting
AM For reception of AM broadcasting

FM-AM IF BAND SWITCH

FM and AM IF (intermediate frequency) passband can be set to for wide or narrow.

This switch is used to select between NARROW (narrow band) and WIDE (wide band). In this way, it is possible to change over the pass bandwidth of the intermediate frequency signals.

NARROW When tuning in the desired station, and if adjacent station interference is a problem at the WIDE setting, set switch to this position.

WIDE Set the switch to this position after the desired station was received without adjacent station interference.

For further details, refer to "FM-AM IF BAND SWITCH" on Page 8.

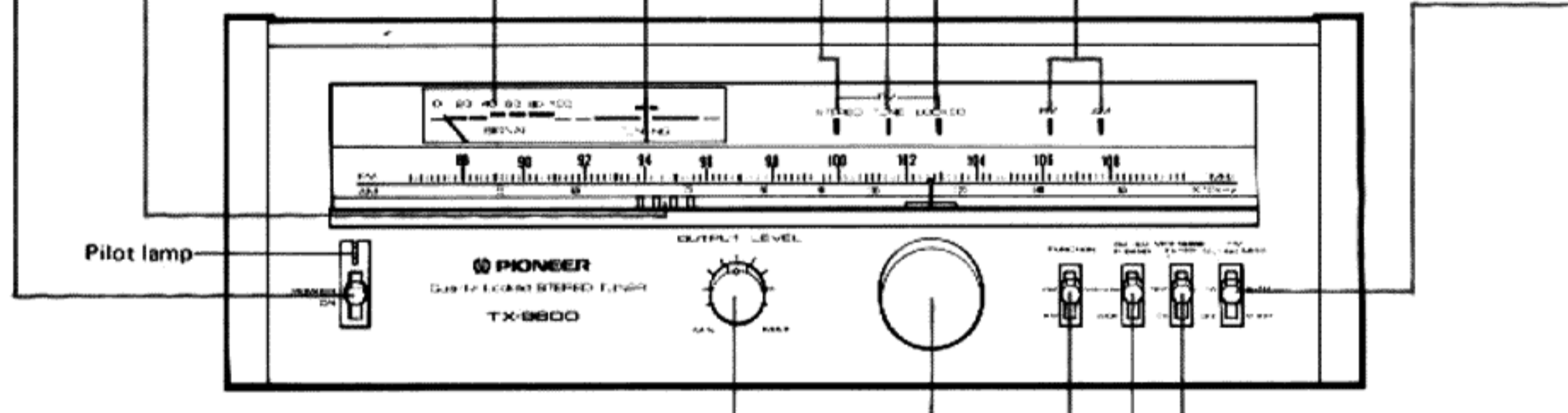

LISTENING TO BROADCASTS

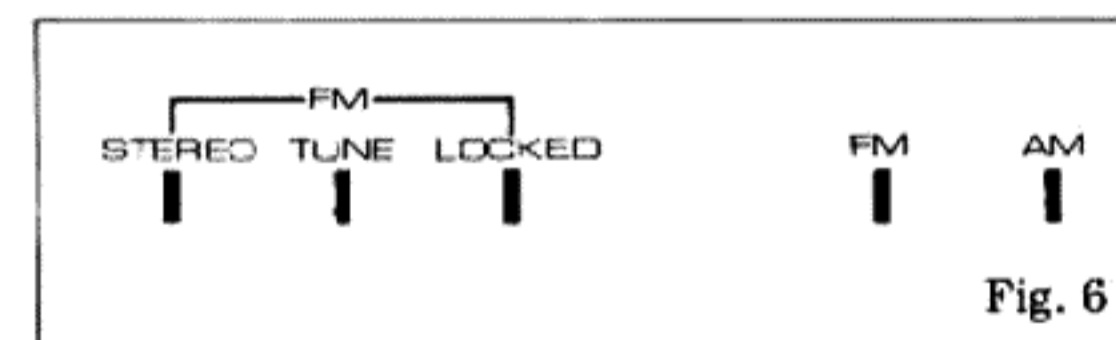

FM RECEPTION

1. Set the power switch to ON.
2. Set the function switch to FM.
3. Set the FM muting switch to ON.
4. Set the FM-AM IF band switch to NARROW. If the desired station can be received clearly without adjacent station interference, set this switch to WIDE after completing the selection. For further details regarding this operation, refer to "FM-AM IF band switch" on page 8.

5. Turn the tuning knob to select the desired station. Operate the tuning knob so that the signal meter pointer deflects toward the far right and also the tuning meter will indicate the center of the scale, with the FM-tune indicator light up as shown in Figs. 6, 7.

When a stereo program is being received, the stereo indicator comes on; if a monaural program is being received, this indicator will remain off.

6. Take your hand off the tuning knob; then, the FM locked indicator will light, indicating that the tuner frequency has been locked to the FM station transmitting frequency.

NOTE:

When touching the tuning knob, do not touch the front panel or tuner body with your other hand. If you touch the front panel or tuner body with your other hand, the touch tune lock system may malfunction.

- If a comparatively high frequency noise is noticed during the reception of stereo program, depress the MPX noise filter switch setting it to the ON position.
- If accurate tuning cannot be obtained even though the signal meter is deflecting, set the FM muting/mode switch to OFF, and begin the tuning process again.



Fig. 7

AM RECEPTION

1. Set the power switch to ON.
2. Set the function switch to AM.
3. Set the FM-AM IF band switch at NARROW. If the desired station can be received clearly without adjacent channel interference, set this switch to WIDE after selection. For further details regarding this operation, refer to "FM-AM IF band switch" on page 8.
4. Select the desired station by adjusting the tuning knob.

The signal meter pointer will strongly deflect toward the right when accurate tuning is obtained, as shown in Fig. 8.

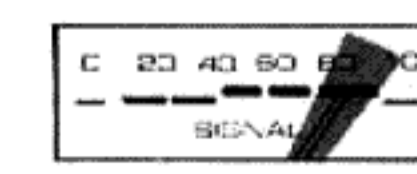

Fig. 8

ACCESSORY FUNCTIONS

FM MUTING/MODE SWITCH

This switch is used to eliminate unpleasant inter-station noise which occurs during selection of FM broadcasting stations. The muting circuit suppresses this noise, and makes FM selection easier.

- In the areas where the distance from the FM station is comparatively small, set this switch to ON.
- In the areas where the field strength is very weak, set this switch to OFF during selection. A distant, weak station can be received even though the noise becomes greater.
- If recording of a stereo FM program onto monoaural tape is desired, set this switch to MONO.

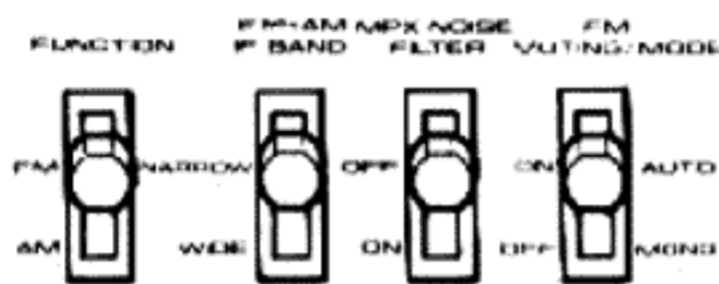

Fig. 9

FM/AM IF BAND SWITCH

The FM/AM IF band switch is used to switch the intermediate frequency signal pass band width of FM and AM between NARROW (narrow band) and WIDE (wide band). If there is a station close to the desired station, set this switch to NARROW; the selectivity will become sharp, and interference will be avoided. On the other hand, if there is not a station close nearby, set this switch to WIDE; the sound quality of the received program will be improved. Further, the behavior of the signal meter pointer varies according to the switch position; WIDE or NARROW. When set to WIDE, the width of the tuning point is comparatively large, and the pointer moves slowly. At NARROW position, the pointer moves sharply as the width of the tuning point is very narrow.

OUTPUT LEVEL KNOB

The Tuner is provided with variable output jacks whose output level can be varied by adjusting the output level knob on the front panel, and also fixed output jacks whose output level is fixed.

Using the VARIABLE jacks

The output level can be adjusted using the output level knob, thereby making it possible to bring the output levels of the Tuner and of the other components connected to the stereo amplifier in line with each other.

FM-DOLBY RECEPTION

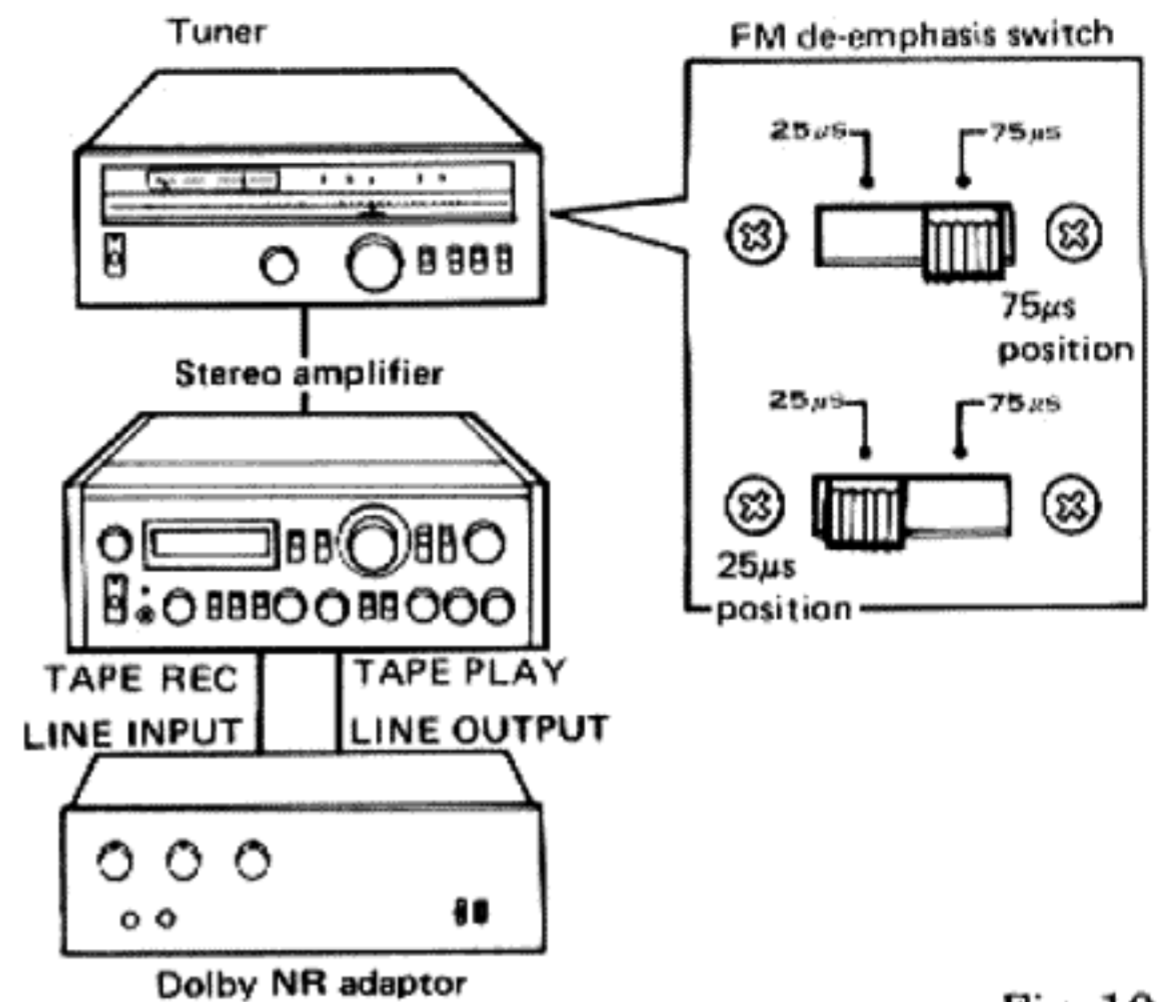

Fig. 10

The FM de-emphasis switch is provided to allow reception of FM-Dolby broadcasts in locations where these programs are being transmitted. A separately sold adaptor must be connected to the stereo amplifier in this case, then proceed according to the following steps:

1. As shown in Fig. 10, connect the Dolby NR adaptor to the tape (record & play) jacks of the stereo amplifier.
2. Set the rear panel FM de-emphasis switch to 25 μ s.
3. Set the tape monitor switch of the stereo amplifier to ON.
4. Set the function switch to the FM position and use the tuning knob to tune in to an FM-Dolby broadcast. Tuning is performed in the same manner as described in "LISTENING TO BROADCASTS."
5. Operate the adaptor and set for reception. Adjust the volume and tone with the controls of the stereo amplifier.

NOTES:

- Refer to the Dolby NR adaptor operating instructions regarding connection and operation.
- When not listening to FM-Dolby broadcasts, be sure to set the FM de-emphasis switch to 75 μ s.

INSTALLING THE FM ANTENNA

It is necessary to choose the installation location for the FM antenna prudently so that you will be able to receive FM stereo broadcasts with both optimum stability and sound quality.

Bear in mind the items below, and then find the best location (height and direction).

1. The ideal place for the antenna is somewhere where it will pick up the signals directly from the transmitting antenna of the FM broadcasting station. If you install the antenna between high-rise blocks or on the other side of buildings or similar obstacles where it will not be able to pick up the signals directly, you will find that multipath distortion is caused by the effects of the reflected radio waves bouncing off those obstacles. This means that the channel separation is sometimes impaired.

Refer to the sections on page 10 on "FM MULTIPATH DISTORTION" and choose a height and direction for the antenna where the effects of multipath distortion are minimal.

2. Install your antenna as far away as possible from roads and highways so the ignition noise of automobiles will not interfere with reception. Also, set your antenna at a distance from high-tension power transmission lines and neon signs.
3. Install the antenna at a distance of not less than 2 meters from a metal roof, concrete buildings, and TV antennas.

FM MULTIPATH DISTORTION

Multipath distortion occurs when FM signals are reflected by mountains, buildings and other obstacles lying in the path of the signals and enter the antenna from various directions, as shown in the accompanying figure. Due to the different distances travelled by the reflected signals, the slight time difference with which they strike the antenna causes mutual interference. This results in phase distortion, distortion of the received sound, reduced channel separation, and a downgraded signal-to-noise ratio. The tuner is liable to be affected by this phenomenon when the radio waves are weak.

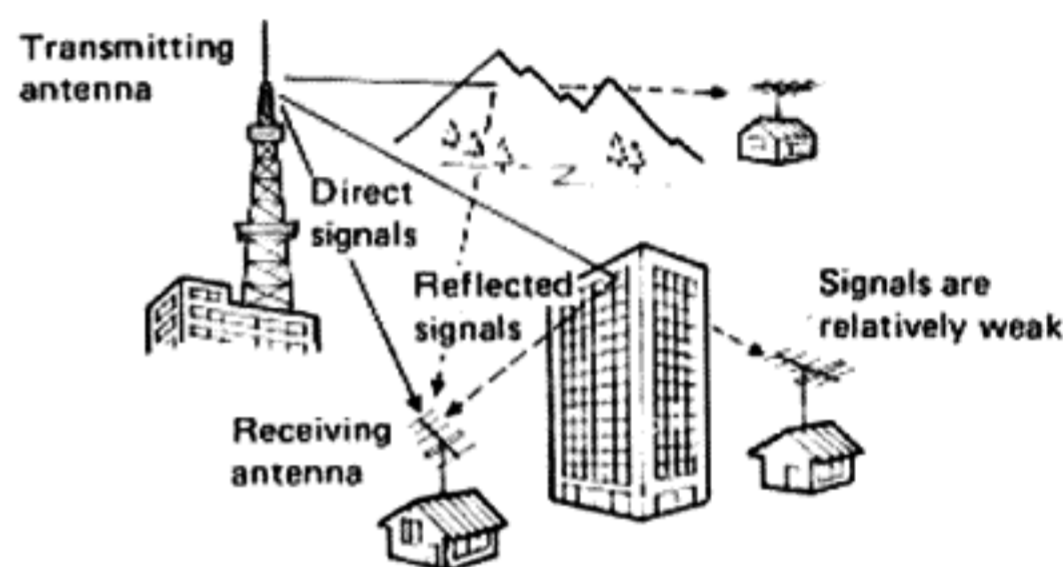
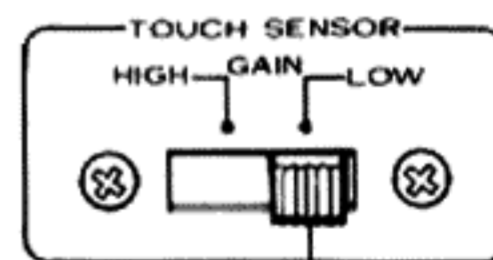

Fig. 11

USING THE TOUCH SENSOR SENSITIVITY SELECTOR FOR FM TUNING

The touch tuning sensor used with this model works with the inductive hum from the body. Depending on the ambient conditions during operation, however, the touch sensitivity may undergo great change.

To compensate for this, the rear panel of the model is equipped with a touch sensor sensitivity selector switch. When the model is shipped, this switch is set to the LOW position for use under normal conditions. However, if for some reason, the inductive hum from the body is at a low level, the FM-tune indicator may not come on and the FM-locked indicator will light up directly even when a program is being received. In cases like this, set the selector switch to the HIGH position.



Touch sensor sensitivity selector

FM MULTIPATH DISTORTION

Just like when erecting an FM antenna, it is very difficult to choose the right direction for optimum reception by yourself. Get somebody to give you a hand and perform the following adjustments.

Adjustments when using a stereo amplifier

1. As shown in Fig. 12, connect "H" (Horizontal) multipath output jack of the tuner to the AUX input L (left) channel jack of the stereo amplifier, and "V" (Vertical) multipath output jack to the AUX input R (right) channel jack.
2. Set the function switch to AUX of the stereo amplifier.
3. Turn down the volume of both stereo amplifier channels and tune into an FM station. Next, increase the volume a little at a time. Through the left channel will be heard the sound of signals with an accentuated treble, while through the right channel will be heard the multipath distortion noise (AM components formed by the reflected radio waves).
4. Turn down the sound of the left channel using the stereo amplifier's balance control, and adjust the direction of the antenna so that the multipath distortion is reduced to the minimum, all the while listening to the sound through the right channel.

Adjustments when using an oscilloscope

1. As shown in Fig. 13, connect the H (horiz) multipath output jack at the rear of the tuner to the horiz axis input jack on the oscilloscope and the V (vert) multipath output jack to the vert axis input jack with good quality shielded wires.
2. Tune into an FM station so that the tuner is perfectly tuned.
3. Adjust the oscilloscope controls and observe the wave-forms.
4. The multipath wave-forms appear in a number of differing patterns in accordance with the height and direction of the antenna and with the strength of the radio waves. In addition, they are undergoing variations all the time due to the strength of the audio signals. The wave-forms illustrated in Photo A of Fig. 14 are an example of what you can expect to observe when the multipath distortion is relatively high. In order to reduce the multipath distortion, adjust the height and direction of the antenna so that the patterns become linear (see Photo B of Fig. 14).

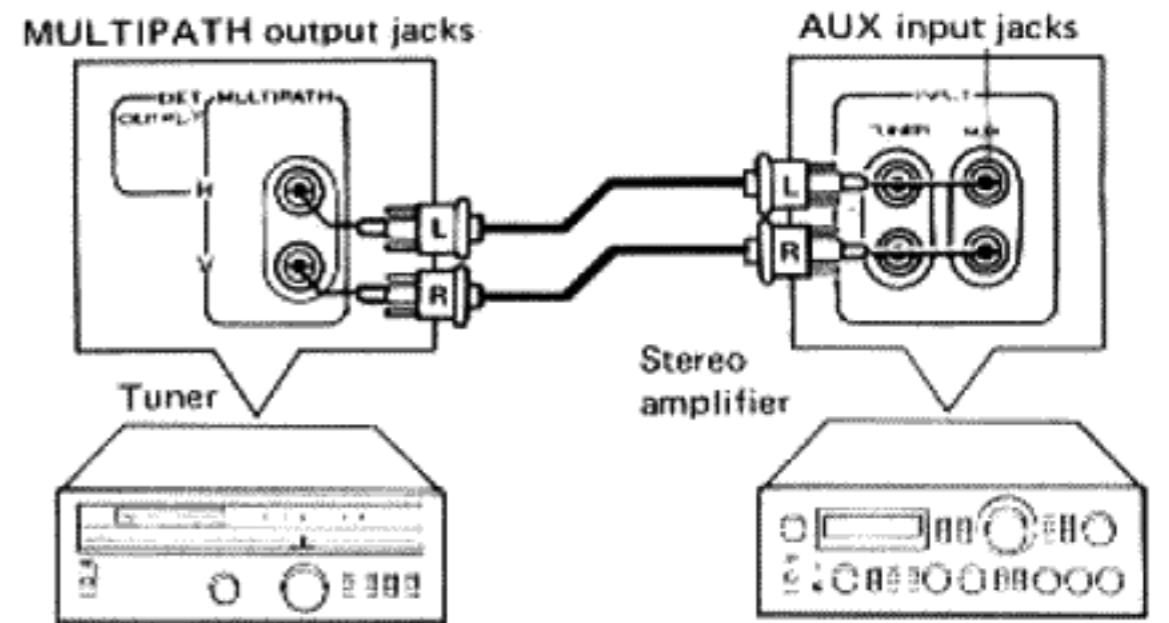

The multipath distortion can be heard through the right-hand speaker. **Fig. 12**

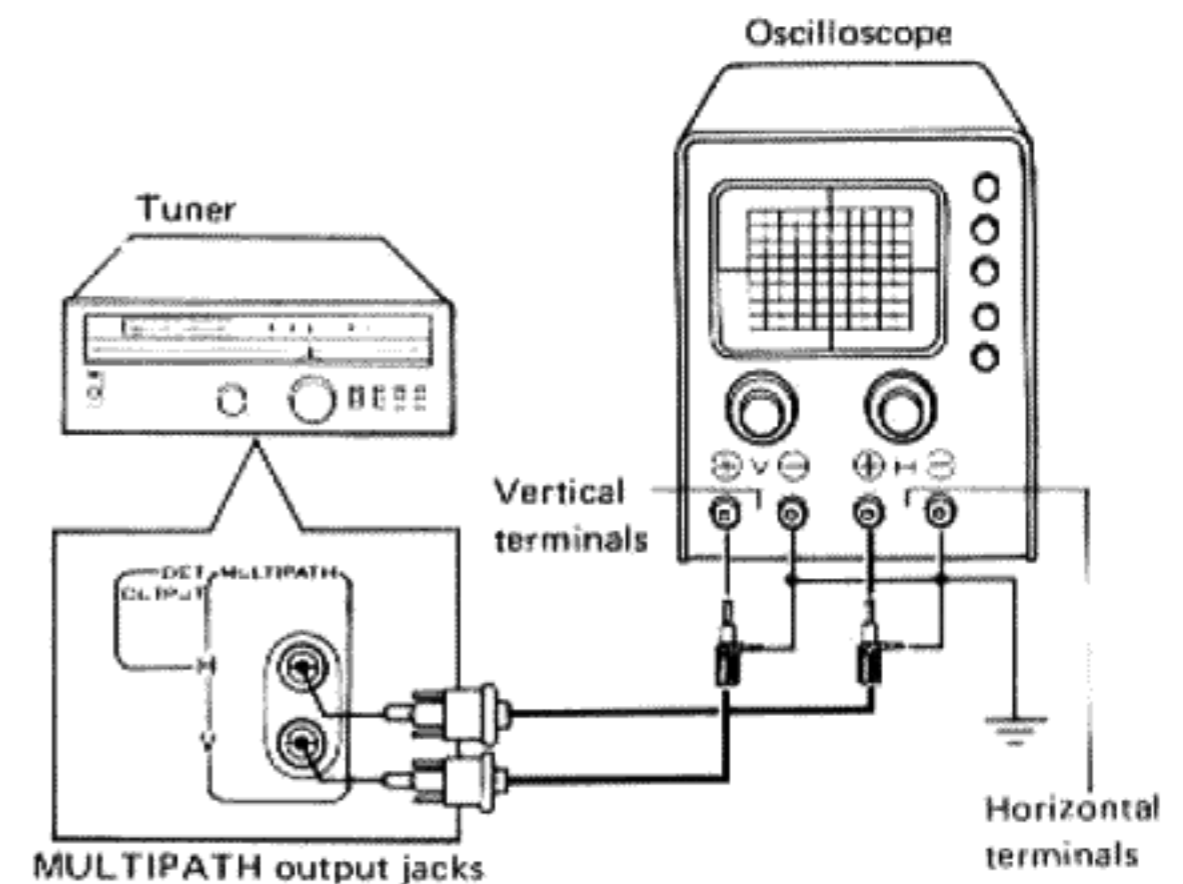

Fig. 13

Photo A: a high level of multipath distortion.

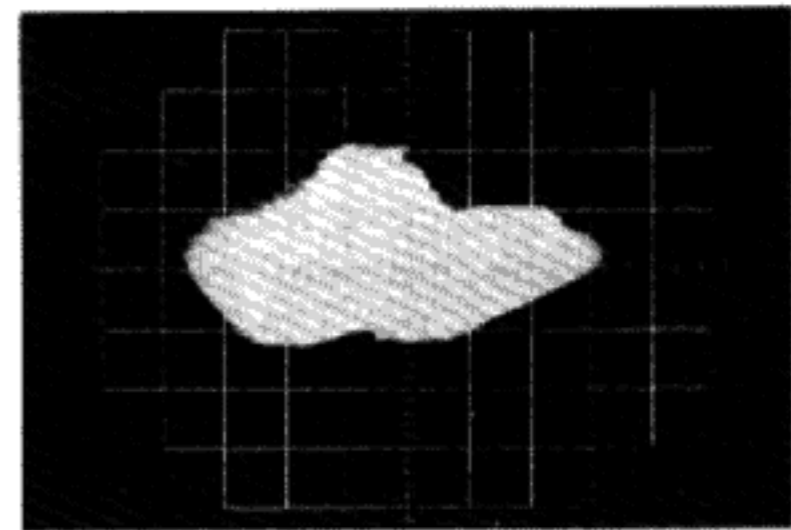

Photo B: no multipath distortion.

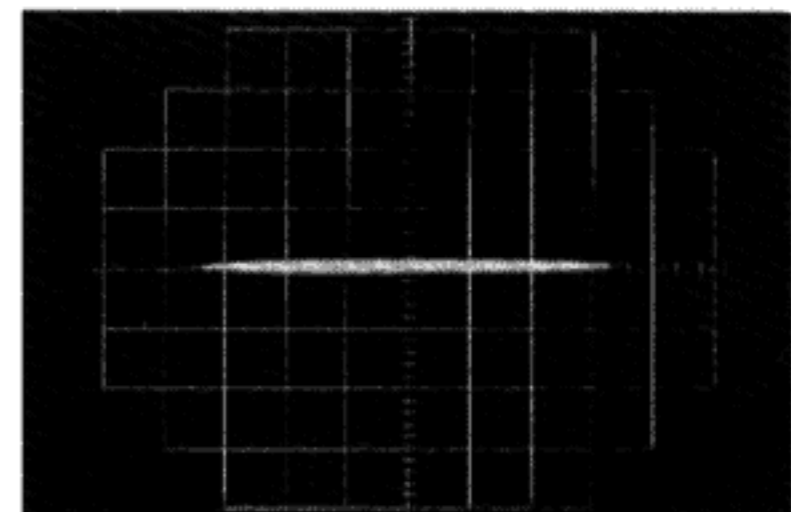

Fig. 14

SPECIFICATIONS

Semiconductors

ICs	11
FETs	11
Transistors	30
Diodes	48

FM Section

Usable Sensitivity	MONO:	8.8dBf (1.5 μ V)
50dB Quieting Sensitivity	MONO:	13.2dBf (2.5 μ V)
	STEREO:	36.1dBf (35 μ V)
Signal-to-Noise Ratio at 85dBf	MONO:	83dB
	STEREO:	80dB
Distortion at 85dBf	MONO:	100Hz 0.05%
		1kHz 0.04%
		10kHz 0.06%
	STEREO:	100Hz 0.1%
		1kHz 0.07%
		10kHz 0.2%
		WIDE NARROW
Capture Ratio		0.8dB 2.0dB
Alternate Channel Selectivity		30dB 85dB
Stereo Separation	1kHz:	55dB
	20Hz to 10kHz:	40dB
Frequency Response	20Hz to 10kHz	± 0.2 dB
	20Hz to 15kHz	± 0.5 dB
Spurious Response Ratio		110dB
Image Response Ratio		120dB
IF Response Ratio		110dB
AM Suppression Ratio		65dB
Subcarrier Product Ratio		70dB
Muting Threshold		19.2dBf(5 μ V)
De-Emphasis Switch (Switchable)		25 μ s ~ 75 μ s
Antenna Input		300ohms balanced
		75ohms unbalanced

AM Section

Sensitivity	
IHF, ferrite antenna	300 μ V/m
IHF, external antenna	15 μ V
Selectivity	WIDE; 20dB
	NARROW; 50dB
Signal-to-Noise Ratio	55dB
Image Response Ratio	70dB
IF Response Ratio	65dB
Antenna	Ferrite Loopstick Antenna

Audio Section

Output (Level/Impedance)	
FM (100% MOD.)	FIXED: 650mV/4.2k Ω
	VARIABLE: 50mV to
	1.3V/3.6k Ω
AM (30% MOD.)	FIXED: 200mV/4.2k Ω
	VARIABLE: 15mV to
	400mV/3.6k Ω
Multipath	
V (Vertical)	300mV/10k Ω
	(AM 1kHz 30% MOD)
H (Horizontal)	400mV/7k Ω
	(FM 1kHz 100% MOD)

Miscellaneous

Power Requirements	120V 60Hz only.
Power Consumption	28W
Dimensions	453(W) x 155(H) x 390(D) mm
	17-11/16 x 6-1/8 x 15-3/8 in
Weight	Without Package:
	9.3kg (20lb 8oz)

Furnished Parts

FM T-type antenna	1
Connection Cord with Pin Plugs	1
Operating Instructions	1

NOTE:

Specifications and the design subject to possible modification without notice due to improvements.

CONDITIONS FREQUENTLY MISTAKEN FOR MALFUNCTIONS

If the TX-9800 is not displaying its usual tip-top performance on account of the poor sound level or a great deal of noise, check the points listed below:

- Sound is not heard: Check the connections and operation procedure again, referring to the "Operating Instructions."

- Great deal of noise: Referring to the table below, diagnose and remedy the symptoms. If you find it difficult to analyze the source of the noise, get in touch with your nearest Pioneer After-Service Center or Service Station.

SYMPTOM	SUSPECTED SOURCE OF NOISE	DIAGNOSIS AND REMEDY
When you start to receive a broadcast, there is a continuous or intermittent noise like "jjjj" or "zzzz".	<ul style="list-style-type: none"> • Static or lightning. • Fluorescent lamp, motor or electrical appliance with thermostat may be in use in or near the house. 	If it often very difficult to remove the cause of the noise. However, in order to raise the level of the input signals above the noise level, set up a good FM antenna outside and make a complete grounding.
Sound is distorted and separation is downgraded even though the broadcasting station is nearby.	<ul style="list-style-type: none"> • There may be a TV/FM community antenna in use in the building. This is causing mismatching in the antenna input. • The radio signals are too strong. • The radio signals are being multipath-reflected. 	Check the distributor and attain the correct matching. Insert an attenuator into the antenna. Vary the location and direction of the antenna to find where there is least distortion (refer to "FM MULTIPATH DISTORTION" on page 10).
When you start to receive broadcasts, there is a humming sound or a "zzzzz."	<ul style="list-style-type: none"> • Ignition noise generated from automobile engines. • A high-frequency sewing machine or welding set is being used in the vicinity. 	In an area surrounded by hills, mountains or high buildings or in an area which is distant from the broadcasting station, the FM input signals will be weak and so the tuner's built-in noise control circuit (limiter) will not work and the noise will increase. Stop using the simple antenna and set up an FM outdoor antenna having a great many director elements.
The amount of noise is higher when listening to an FM stereo program than when listening to a mono broadcast.	<ul style="list-style-type: none"> • This is because with FM stereo broadcasts the service area is about half that of ordinary mono broadcasts. 	In order to increase the antenna input of the radio signals, erect an exclusive FM outdoor antenna when listening with the indoor T-type antenna.

Handling Precautions of the touch tuning system

- If receipt of the broadcasting wave is cut off while the power is connected to this tuner, the lock may be lost even after recovery of the wave. If this should happen, readjust the tuning. If the power is cut off and then reconnected again by a digital timer or something similar, as in the case of unattended recording, the relocking circuit will function normally.
- If the tuning knob is adjusted while wearing gloves, the FM LOCKED indicator may not go out. This is because the hand is insulated from the knob. In such a case, remove the glove, and readjust.
- The FM LOCKED indicator may not be lighted at some locations. This means that the tuner is being influenced by the household power line. Change the installed location, height and/or routing of the power cord, and the indicator will operate normally.